

CP 155

CP 155



REYNAERS
aluminium

Cat. nr. 34
Art. nr. AD.089.C34D.00 (v01)
Edition 12/2011

Inhoud
Sommaire
Content
Inhalt

- A Algemene informatie
 Généralités
 General Information
 Allgemeine Information
- B Algemene informatie systemen
 Généralités séries
 General Information System
 Allgemeine Information System
- C Profielen
 Profilés
 Profiles
 Profile
- E Werktekeningen
 Coupes et débits
 Work drawings
 Werkzeichnungen
- F Montagetekeningen
 Fabrication et montage
 Assembly drawings
 Montagezeichnungen
- G Toebehoren
 Accessoires
 Accessories
 Zubehör



Inhoud

INHOUDSTAFEL 34.001-008

Algemene informatie

SYMBOLENLIJST 34.A.001-007
OVERZICHT TESTRAPPORTEN 34.A.008-010

Algemene informatie systemen

VERWERKINGSVOORSCHRIFTEN 34.B.001-004

Profielen

PROFIELOVERZICHT 34.C.001-007
BUITENKADERS 34.C.008-009
BUITENKADER 34.C.010
BUITENKADER INBRAAKWEREND 34.C.011
BUITENKADER 34.C.012
BUITENKADERS MONORAIL 34.C.013-014
AFDEKPROFIEL BUITENKADER MONORAIL 34.C.015
BUITENKADER 3-RAIL 34.C.016-018
BUITENKADER MONORAIL 34.C.019-022
AFDEKPROFIEL BUITENKADER MONORAIL VLEUGELS 34.C.023
VLEUGELS 34.C.024
VLEUGELS INBRAAKWEREND 34.C.025
HULPPROFIELEN VLEUGEL 34.C.026-027
VERSTERKINGSPROFIELEN VLEUGEL 34.C.028
VERSTEVIJGINGSPROFIEL VLEUGEL 34.C.029
T-PROFIELEN 34.C.030-033
T-PROFIEL 34.C.034
WISSELPROFIEL 34.C.035
GLASLATTEN 34.C.036-037
GLASLATTEN INBRAAKWEREND 34.C.038
ROLLUIKGELEIDERS 34.C.039-041
DILATATIEPROFIEL 34.C.042
KOPPELPROFIEL 34.C.043-044
AFWERKINGSPROFIEL 34.C.045
HULPPROFIELEN 34.C.046
AFWERKINGSPROFIEL 34.C.047
WISSELPROFIEL 34.C.048
AFDEKKAP MOTOR 34.C.049
BUITENKADER 34.C.050
BEVESTIGINGSPROFIEL REYNACONNECT 34.C.051-052

Werktekeningen

OVERZICHT 34.E.001
OVERZICHT ISOLATIE VARIANTEN 2-RAIL/3-RAIL 34.E.002-005
OVERZICHT ISOLATIE VARIANTEN MONORAIL 34.E.006-009
OVERZICHT ISOLATIE VARIANTEN 2-RAIL/3-RAIL 34.E.010-013
OVERZICHT ISOLATIE VARIANTEN MONORAIL 34.E.014-019
OVERZICHT ISOLATIE VARIANTEN FLAT-BOTTOM 34.E.020-021
OVERZICHT ISOLATIE VARIANTEN 34.E.022-023
OVERZICHT ISOLATIE VARIANTEN MONORAIL MINERGIE 34.E.024-027
OVERZICHT 34.E.028-031
2-RAIL XQ 34.E.032-037
2-RAIL XO 34.E.038-043
2-RAIL QXX 34.E.044-049
2-RAIL QXXQ 34.E.050-055
2-RAIL OXXO 34.E.056-061
MONORAIL XQ 34.E.062-069
MONORAIL QXX 34.E.070-075
MONORAIL QXXQ 34.E.076-081
3-RAIL XXQ 34.E.082-087
3-RAIL XXO 34.E.088-093
2-RAIL XQ 34.E.094-101
2-RAIL XQ FLAT BOTTOM 34.E.102-107
2-RAIL XX 34.E.108-113
2-RAIL QXX 34.E.114-119
2-RAIL QXXQ 34.E.120-125
2-RAIL XXXX 34.E.126-131
2-RAIL QXQ 34.E.132-137
MONORAIL XQ 34.E.138-145
MONORAIL QXX 34.E.146-151
MONORAIL QXXQ 34.E.152-157
3-RAIL XXQ 34.E.158-163
3-RAIL XXX 34.E.164-169
AUTOMATISCHE HEFSCHUIFDEUR 34.E.170-175
MONORAIL XQ 34.E.176-183
MONORAIL QXX 34.E.184-189
MONORAIL QXX 34.E.190-195
MONORAIL QXXQ 34.E.196-201
2-RAIL XQ INBRAAKWEREND 34.E.202-205
2-RAIL XQ 34.E.206-208
2-RAIL 34.E.209
2-RAIL XQ 34.E.210-213
2-RAIL QXXQ 34.E.214

Montagetekeningen

ONTWATERING TYPE XQ XO QXX 34.F.001-003
ONTWATERING TYPE QXX QXXQ OXXO 34.F.004-005
ONTWATERING TYPE XQ XX QXX 34.F.006-007
ONTWATERING TYPE QXX QXXQ OXXO 34.F.008-009
ONTWATERING MONORAIL TYPE XQ 34.F.010-011
ONTWATERING MONORAIL TYPE QXX 34.F.012-013
ONTWATERING MONORAIL TYPE QXXQ 34.F.014-015
ONTWATERING MONORAIL TYPE XQ 34.F.016-017
ONTWATERING MONORAIL TYPE QXX 34.F.018-019
ONTWATERING MONORAIL TYPE QXXQ 34.F.020-021
ONTWATERING TYPE XXX XXQ 34.F.022-025
ONTWATERING MONORAIL TYPE XQ 34.F.026-027

ONTWATERING MONORAIL TYPE QXX QXX 34.F.028-029
ONTWATERING MONORAIL TYPE QXXQ 34.F.030-031
ONTWATERING FLAT BOTTOM 34.F.032-033
DECOMPRESSIE VLEUGELS 34.F.034
ONTWATERING VLEUGEL 34.F.035
PERSHOEKVERBINDING 34.F.036-037
SCHROEFHOEKVERBINDING 34.F.038-039
PERSHOEKVERBINDING MONORAIL 34.F.040-041
SCHROEFHOEKVERBINDING MONORAIL 34.F.042-043
MONTAGE BUITENKADER 34.F.044-047
MONTAGE BUITENKADER MONORAIL 34.F.048-049
MONTAGE BUITENKADER 3-RAIL 34.F.050-051
MONTAGE BUITENKADER 34.F.052-055
HOEKVERBINDING VLEUGEL 34.F.056-057
SCHROEFHOEKVERBINDING VLEUGEL 34.F.058-059
T-VERBINDINGEN 34.F.060-061
T-VERBINDER MET SCHROEF EN/OF NAGEL 34.F.062-063
T-VERBINDING MONORAIL 34.F.064-071
MONTAGE AFDICHTING MET BORSTEL 34.F.072
MONTAGE AFDICHTING MET BORSTEL MONORAIL 34.F.073
MONTAGE AFDICHTING MET BORSTEL 34.F.074
MONTAGE AFDICHTING MET BORSTEL MONORAIL 34.F.075
AFDICHTING MET BORSTEL 34.F.076-077
MONTAGE SCHUIFVLEUGEL 34.F.078-081
BEWERKEN MIDDENSTIJL 4-SLAG 34.F.082-084
BEWERKEN MIDDENSTIJL 4-SLAG MONORAIL 34.F.085-087
UITWERKING VLOERPROFIEL MONORAIL 34.F.088-089
INBOUW VEILIGHEIDSSLOT 34.F.090
INBOUW VEILIGHEIDSSLOT 4-SLAG 34.F.091
UITFREZING BESLAG VOOR SLOT 34.F.092-093
INBOUW 5-PUNTSSLUITING 34.F.094-095
INBOUW BASISSET HEFSCHUIFDEUR 34.F.096-097
INBOUW BASISSET HEFSCHUIFDEUR 4-SLAG 34.F.098-099
INBOUW BASISSET HEFSCHUIFDEUR 4-SLAG MIN. 300KG 34.F.100-101
BASISSET AUTOMATISCHE HEFSCHUIFDEUR 34.F.102-105
INBOUW BASISSET HEFSCHUIFDEUR 4-SLAG 34.F.106-107
MONTAGE DEURKRUK 34.F.108-109
MONTAGE DEURKRUK KABA 34.F.110-111
SLOTOVERZICHT 34.F.112
UITFREZING BESLAG VOOR SLOT 34.F.113
INBRAAKWEREND 34.F.114-115
KOPPELING MET ANDERE SYSTEMEN 34.F.116-119
BUFFER 34.F.120-121
BOUWAANSLUITING 34.F.122-129
KOPPELSTUK 34.F.130-131
GLASSTEUNEN 34.F.132
MONTAGE KLEMSTUK 34.F.133
MONTAGE 062.7927.04 / 062.8045.04 34.F.134-135
MONTAGE HULPPROFIEL INBRAAKWEREND 34.F.136-137
BEGLAZINGSTABEL 34.F.138-141
MAX. TOELAATBARE AFMETINGEN VLEUGELS 34.F.142-149
MAX. TOELAATBARE LENGTEN VLEUGELS 34.F.150
MAX. TOELAATBARE AFMETINGEN VLEUGELS 34.F.151-157
ALGEMEEN 34.F.158-160

Toebehoren

OVERZICHT 34.G.001-007
PERSHOEKEN 34.G.008
SCHROEFHOEKEN 34.G.009
VULHOEKEN 34.G.010
STEUNHOEKEN 34.G.011-012
EINDSTUKKEN 34.G.013
T-VERBINDING 34.G.014-015
T-VERBINDER 34.G.016
T-VERBINDERS 34.G.017-018
AFDICHTINGSSTUK T-VERBINDER 34.G.019
T-VERBINDER 34.G.020
T-VERBINDER VARIABEL 34.G.021
DEURKRUKKEN 34.G.022-029
HANDGREEP 34.G.030
DEURKRUKKEN 34.G.031
INBRAAKWEREND 34.G.032
SLOTEN HEFSCHUIFDEUR 34.G.033
HAAKSLOTEN 34.G.034
SLOTPADEN 34.G.035
CILINDER 34.G.036
SLOTPADEN 34.G.037
BASISSET HEFSCHUIFDEUR 34.G.038
SLOTEN HEFSCHUIFDEUR 34.G.039
SLOTEN 34.G.040
GLASSTEUN 34.G.041
WIEL 34.G.042
BUFFER 34.G.043
ALGEMENE TOEBEHOREN 34.G.044-047
BEGLAZINGSDICHTINGEN 34.G.048
BEGLAZINGSDICHTING 34.G.049
BEGLAZINGSDICHTINGEN 34.G.050-052
DICHTINGEN 34.G.053-056
AFDICHTINGEN 34.G.057-059
BORSTELDICHTINGEN 34.G.060
ISOLEREND VULSTUK 34.G.061
VERANKERINGEN 34.G.062-063
DIVERSEN 34.G.064-074
BEVESTIGINGSMIDDELEN 34.G.075-089
SCHUIFDEUR KIT 34.G.089_01.001
BASISSET AUTOMATISCHE HEFSCHUIFDEUR 34.G.089_01.002-091
BOORMALLEN EN MATRIJZEN 34.G.092
BOORMAL T-VERBINDING VARIABEL 34.G.093
BOORMAL T-VERBINDING 34.G.094
BOORMAL ONTWATERING 34.G.095
BOORMAL SCHROEFVERBINDING 34.G.096
BOORMAL 34.G.097
BOORMAL SCHROEFHOEK 34.G.098
PONSUNIT HOEK- EN T-VERBINDING 34.G.099-100
PONSUNIT T-VERBINDING 34.G.101
PONSUNIT ONTWATERING 34.G.102
PONSUNIT WISSELPROFIEL 34.G.103
PONSUNIT SCHROEFVERBINDING 34.G.104
Sjablonen voor 095.A700.00 34.G.105
Sjablonen voor 095.B300.00 34.G.106



PERSBLOK VOOR 095.H800.00
PERSBLOKKEN
MESSEN
PERSBLOK VOOR 095.B500.00
MESSEN VOOR 095.B500.00

34.G.107
34.G.108
34.G.109
34.G.110-111
34.G.112-113



Sommaire

TABLE DES MATIERES 34.001-008

Généralités

LISTE DES SYMBOLES 34.A.001-007
APERÇU RAPPORTS D'ESSAI 34.A.008-010

Généralités séries

PRESCRIPTIONS DE MISE EN OEUVRE 34.B.001-004

Profilés

APERÇU DES PROFILES 34.C.001-007
DORMANTS 34.C.008-009
DORMANT 34.C.010
DORMANT PROTECTION ANTI-VOL 34.C.011
DORMANT 34.C.012
DORMANTS MONORAIL 34.C.013-014
PROFILÉ DE RECOUVREMENT DORMANT MONORAIL 34.C.015
DORMANT 3-RAIL 34.C.016-018
DORMANT MONORAIL 34.C.019-022
PROFILÉ DE RECOUVREMENT DORMANT MONORAIL 34.C.023
OUVRANTS 34.C.024
OUVRANTS PROTECTION ANTI-VOL 34.C.025
PROFILÉS DE RACCORDEMENT OUVRANT 34.C.026-027
PROFILÉS DE RENFORCEMENT OUVRANT 34.C.028
PROFILÉ DE RENFORCEMENT OUVRANT 34.C.029
TRAVERSES 34.C.030-033
TRAVERSE 34.C.034
CHICANE 34.C.035
PARCLOSES 34.C.036-037
PARCLOSES PROTECTION ANTI-VOL 34.C.038
GUIDES A VOLET 34.C.039-041
PROFILÉ DE DILATATION 34.C.042
PROFILÉ DE RACCORDEMENT 34.C.043-044
PROFILÉ DE FINITION 34.C.045
PROFILÉS DE RACCORDEMENT 34.C.046
PROFILÉS DE FINITION 34.C.047
CHICANE 34.C.048
CAPUCHON POUR MOTEUR 34.C.049
DORMANT 34.C.050
SUPPORT DE MONTAGE REYNACONNECT 34.C.051-052

Coupes et débits

APERÇU 34.E.001
APERÇU VARIANTES D'ISOLATION 2-RAIL/3-RAIL 34.E.002-005
APERÇU VARIANTES D'ISOLATION MONORAIL 34.E.006-009
APERÇU VARIANTES D'ISOLATION 2-RAIL/3-RAIL 34.E.010-013
APERÇU VARIANTES D'ISOLATION MONORAIL 34.E.014-019
APERÇU VARIANTES D'ISOLATION FLAT-BOTTOM 34.E.020-021
APERÇU VARIANTES D'ISOLATION 34.E.022-023
APERÇU VARIANTES D'ISOLATION MONORAIL MINERGIE 34.E.024-027
APERÇU 34.E.028-031
2-RAIL XQ 34.E.032-037
2-RAIL XO 34.E.038-043
2-RAIL XQX 34.E.044-049
2-RAIL QXXQ 34.E.050-055
2-RAIL OXXO 34.E.056-061
MONORAIL XQ 34.E.062-069
MONORAIL XQX 34.E.070-075
MONORAIL QXXQ 34.E.076-081
3-RAIL XXQ 34.E.082-087
3-RAIL XXO 34.E.088-093
2-RAIL XQ 34.E.094-101
2-RAIL XQ FLAT BOTTOM 34.E.102-107
2-RAIL XX 34.E.108-113
2-RAIL XQX 34.E.114-119
2-RAIL QXXQ 34.E.120-125
2-RAIL XXXX 34.E.126-131
2-RAIL QXQ 34.E.132-137
MONORAIL XQ 34.E.138-145
MONORAIL XQX 34.E.146-151
MONORAIL QXXQ 34.E.152-157
3-RAIL XXQ 34.E.158-163
3-RAIL XXX 34.E.164-169
SOULEV. COULISSANT AUTOMATIQUE 34.E.170-175
MONORAIL XQ 34.E.176-183
MONORAIL QXQ 34.E.184-189
MONORAIL XQX 34.E.190-195
MONORAIL QXXQ 34.E.196-201
2-RAIL XQ PROTECTION ANTI-VOL 34.E.202-205
2-RAIL XQ 34.E.206-208
2-RAIL 34.E.209
2-RAIL XQ 34.E.210-213
2-RAIL QXXQ 34.E.214

Fabrication et montage

DRAINAGE TYPE XQ XO XQX 34.F.001-003
DRAINAGE TYPE QXQ QXXQ OXXO 34.F.004-005
DRAINAGE TYPE XQ XX XQX 34.F.006-007
DRAINAGE TYPE QXQ QXXQ OXXO 34.F.008-009
DRAINAGE MONORAIL TYPE XQ 34.F.010-011
DRAINAGE MONORAIL TYPE XQX 34.F.012-013
DRAINAGE MONORAIL TYPE QXXQ 34.F.014-015
DRAINAGE MONORAIL TYPE XQ 34.F.016-017
DRAINAGE MONORAIL TYPE XQX 34.F.018-019
DRAINAGE MONORAIL TYPE QXXQ 34.F.020-021
DRAINAGE TYPE XXX XQX 34.F.022-025
DRAINAGE MONORAIL TYPE XQ 34.F.026-027

DRAINAGE MONORAIL TYPE XQX QXQ 34.F.028-029
DRAINAGE MONORAIL TYPE QXXQ 34.F.030-031
DRAINAGE FLAT BOTTOM 34.F.032-033
DECOMPRESSION OUVRANTS 34.F.034
DRAINAGE OUVRANT 34.F.035
ASSEMBLAGE EQUERRE A SERTIR 34.F.036-037
ASSEMBLAGE EQUERRE A BLOCAGE 34.F.038-039
ASSEMBLAGE EQUERRE A SERTIR MONORAIL 34.F.040-041
ASSEMBLAGE EQUERRE A BLOCAGE MONORAIL 34.F.042-043
ASSEMBLAGE DORMANT 34.F.044-047
ASSEMBLAGE DORMANT MONORAIL 34.F.048-049
ASSEMBLAGE DORMANT 3-RAIL 34.F.050-051
ASSEMBLAGE DORMANT 34.F.052-055
ASSEMBLAGE ANGULAIRE OUVRANT 34.F.056-057
ASSEMBLAGE EQUERRE OUVRANT 34.F.058-059
RACCORDEMENTS-T 34.F.060-061
JONCTION-T AVEC VIS ET/OU CHEVILLE 34.F.062-063
RACCORDEMENT-T MONORAIL 34.F.064-071
MONTAGE FERMETURE AVEC BROSSE 34.F.072
MONTAGE FERMETURE AVEC BROSSE MONORAIL 34.F.073
MONTAGE FERMETURE AVEC BROSSE 34.F.074
MONTAGE FERMETURE AVEC BROSSE MONORAIL 34.F.075
FERMETURE AVEC BROSSE 34.F.076-077
MONTAGE VANTAIL COULISSANT 34.F.078-081
USINER LIAISON CENTRALE 4 VANTAUX 34.F.082-084
USINER LIAISON CENTRALE 4 VANTAUX MONORAIL 34.F.085-087
RAINURE PROFILÉ DE SEUIL MONORAIL 34.F.088-089
ENCASTREMENT SERRURE DE SECURITE 34.F.090
ENCASTREMENT SERRURE DE SECURITE 4-VANTAUX 34.F.091
FRAISAGE ACCESSOIRES POUR FERMETURE 34.F.092-093
ENCASTREMENT FERMETURE A 5 POINTS 34.F.094-095
ENCASTREMENT PIECES DE BASE SOULEV. COULISSANT 34.F.096-097
ENCASTREMENT PIECES DE BASE SOULEV. COULISS. 4 34.F.098-099
ENCASTREMENT PIECES DE BASE SOULEV. COULISS. 4 34.F.100-101
SET DE BASE SOULEV. COULISSANT AUTOMATIQUE 34.F.102-105
ENCASTREMENT PIECES DE BASE SOULEV. COULISS. 4 34.F.106-107
ASSEMBLAGE BEQUILLE 34.F.108-109
ASSEMBLAGE BEQUILLE KABA 34.F.110-111
TABLEAU DES FERMETURES 34.F.112
FRAISAGE ACCESSOIRES POUR FERMETURE 34.F.113
PROTECTION ANTI-VOL 34.F.114-115
JONCTION AVEC D'AUTRES SYSTEMES 34.F.116-119
BUTEE 34.F.120-121
RACCORDEMENT AU BATIMENT 34.F.122-129
PIECE DE RACCORDEMENT 34.F.130-131
SUPPORTS CALE DE VITRAGE 34.F.132
ASSEMBLAGE PIECE DE BLOCAGE 34.F.133
ASSEMBLAGE 062.7927.04 / 062.8045.04 34.F.134-135
MONTAGE PROFILÉ DE RACCORDEMENT PROTECTION A 34.F.136-137
TABLEAU DE VITRAGE 34.F.138-141
DIMENSIONS MAX. ADMISSIBLE OUVRANTS 34.F.142-149
LONGUEURS MAX. ADMISSIBLE OUVRANTS 34.F.150
DIMENSIONS MAX. ADMISSIBLE OUVRANTS 34.F.151-157
GENERAL 34.F.158-160

Accessoires

APERÇU 34.G.001-007
EQUERRES A SERTIR 34.G.008
EQUERRES A VISSER 34.G.009
EQUERRES DE REMPLISSAGE 34.G.010
CALES DE FEUILLEURE 34.G.011-012
PIECES FINALES 34.G.013
RACCORDEMENT-T 34.G.014-015
JONCTION-T 34.G.016
JONCTIONS-T 34.G.017-018
PIECE D'ETANCHEITE JONCTION-T 34.G.019
JONCTION-T 34.G.020
JONCTION-T VARIABLE 34.G.021
BEQUILLES 34.G.022-029
MAIN COURANTE 34.G.030
BEQUILLES 34.G.031
PROTECTION ANTI-VOL 34.G.032
SERRURES SOULEV. COULISSANT 34.G.033
SERRURES 34.G.034
GACHES 34.G.035
CYLINDRE 34.G.036
GACHES 34.G.037
SET DE BASE SOULEV. COULISSANT 34.G.038
SERRURES SOULEV. COULISSANT 34.G.039
SERRURES 34.G.040
SUPPORT CALE DE VITRAGE 34.G.041
ROULETTE 34.G.042
BUTEE 34.G.043
ACCESSOIRES GENERAUX 34.G.044-047
JOINTS DE VITRAGE 34.G.048
JOINT DE VITRAGE 34.G.049
JOINTS DE VITRAGE 34.G.050-052
JOINTS 34.G.053-056
FERMETURES 34.G.057-059
JOINTS-BROSSE 34.G.060
PIECE DE REMPLISSAGE ISOLEE 34.G.061
ANCRAGES 34.G.062-063
DIVERS 34.G.064-074
MOYENS DE FIXATION 34.G.075-089
PORTE COULISSANT KIT 34.G.089_01.001-001
SET DE BASE SOULEV. COULISSANT AUTOMATIQUE 34.G.089_01.002-091
CALIBRES DE PERÇAGE ET MATRICES 34.G.092
CALIBRE DE PERÇAGE RACCORDEMENT-T VARIABLE 34.G.093
CALIBRE RACCORDEMENT-T 34.G.094
CALIBRE DE PERÇAGE DRAINAGE 34.G.095
CALIBRE DE PERÇAGE JONCTION A VISSER 34.G.096
CALIBRE DE PERÇAGE 34.G.097
CALIBRE DE PERÇAGE EQUERRE A VISSER 34.G.098
UNITE D'ETAMPER CONNECTION D'EQUERRE ET TRAVÉE 34.G.099-100
UNITE D'ETAMPER JONCTION-T 34.G.101
UNITE D'ETAMPER DRAINAGE 34.G.102
UNITE D'ETAMPER CHICANE 34.G.103
UNITE D'ETAMPER JONCTION A VISSER 34.G.104
POCHOIR POUR 095.A700.00 34.G.105
POCHOIR POUR 095.B300.00 34.G.106



ENCLUME POUR 095.H800.00
ECLUMES
COUTEAUX
ENCLUME POUR 095.B500.00
COUTEAUX POUR 095.B500.00

34.G.107
34.G.108
34.G.109
34.G.110-111
34.G.112-113



Content

TABLE OF CONTENTS 34.001-008

General Information

LIST OF SYMBOLS 34.A.001-007
OVERVIEW TEST REPORTS 34.A.008-010

General Information System

PROCESSING DATA 34.B.001-004

Profiles

PROFILE OVERVIEW 34.C.001-007
OUTER FRAMES 34.C.008-009
OUTER FRAME 34.C.010
OUTER FRAME BURGLAR PROTECTION 34.C.011
OUTER FRAME 34.C.012
OUTER FRAMES MONORAIL 34.C.013-014
COVERING PROFILE OUTER FRAME MONORAIL 34.C.015
OUTER FRAME 3-RAIL 34.C.016-018
OUTER FRAME MONORAIL 34.C.019-022
COVERING PROFILE OUTER FRAME MONORAIL 34.C.023
VENTS 34.C.024
VENTS BURGLAR PROTECTION 34.C.025
ADDITIONAL PROFILES VENT 34.C.026-027
REINFORCEMENT PROFILES VENT 34.C.028
REINFORCEMENT PROFILE VENT 34.C.029
TRANSOM-MULLIONS 34.C.030-033
TRANSOM 34.C.034
MEETING SECTION 34.C.035
GLAZING BEADS 34.C.036-037
GLAZING BEADS BURGLAR PROTECTION 34.C.038
SHUTTER GUIDES 34.C.039-041
EXPANSION PROFILE 34.C.042
CONNECT PROFILE 34.C.043-044
FINISHING PROFILE 34.C.045
ADDITIONAL PROFILES 34.C.046
FINISHING PROFILE 34.C.047
MEETING SECTION 34.C.048
COVER MOTOR 34.C.049
OUTER FRAME 34.C.050
FIXATION PROFILE REYNACONNECT 34.C.051-052

Work drawings

OVERVIEW 34.E.001
OVERVIEW INSULATION VARIANTS 2-RAIL/3-RAIL 34.E.002-005
OVERVIEW INSULATION VARIANTS MONORAIL 34.E.006-009
OVERVIEW INSULATION VARIANTS 2-RAIL/3-RAIL 34.E.010-013
OVERVIEW INSULATION VARIANTS MONORAIL 34.E.014-019
OVERVIEW INSULATION VARIANTS FLAT-BOTTOM 34.E.020-021
OVERVIEW INSULATION VARIANTS 34.E.022-023
OVERVIEW INSULATION VARIANTS MONORAIL MINERGIE 34.E.024-027
OVERVIEW 34.E.028-031
2-RAIL XQ 34.E.032-037
2-RAIL XQ 34.E.038-043
2-RAIL XQX 34.E.044-049
2-RAIL QXXQ 34.E.050-055
2-RAIL OXXO 34.E.056-061
MONORAIL XQ 34.E.062-069
MONORAIL XQX 34.E.070-075
MONORAIL QXXQ 34.E.076-081
3-RAIL XXQ 34.E.082-087
3-RAIL XXO 34.E.088-093
2-RAIL XQ 34.E.094-101
2-RAIL XQ FLAT BOTTOM 34.E.102-107
2-RAIL XX 34.E.108-113
2-RAIL XQX 34.E.114-119
2-RAIL QXXQ 34.E.120-125
2-RAIL XXXX 34.E.126-131
2-RAIL QXQ 34.E.132-137
MONORAIL XQ 34.E.138-145
MONORAIL XQX 34.E.146-151
MONORAIL QXXQ 34.E.152-157
3-RAIL XXQ 34.E.158-163
3-RAIL XXX 34.E.164-169
AUTOMATIC LIFT AND SLIDING DOOR 34.E.170-175
MONORAIL XQ 34.E.176-183
MONORAIL QXQ 34.E.184-189
MONORAIL XQX 34.E.190-195
MONORAIL QXXQ 34.E.196-201
2-RAIL XQ BURGLAR PROTECTION 34.E.202-205
2-RAIL XQ 34.E.206-208
2-RAIL 34.E.209
2-RAIL XQ 34.E.210-213
2-RAIL QXXQ 34.E.214

Assembly drawings

DRAINAGE TYPE XQ XO XQX 34.F.001-003
DRAINAGE TYPE QXQ QXXQ OXXO 34.F.004-005
DRAINAGE TYPE XQ XX XQX 34.F.006-007
DRAINAGE TYPE QXQ QXXQ OXXO 34.F.008-009
DRAINAGE MONORAIL TYPE XQ 34.F.010-011
DRAINAGE MONORAIL TYPE XQX 34.F.012-013
DRAINAGE MONORAIL TYPE QXXQ 34.F.014-015
DRAINAGE MONORAIL TYPE XQ 34.F.016-017
DRAINAGE MONORAIL TYPE XQX 34.F.018-019
DRAINAGE MONORAIL TYPE QXXQ 34.F.020-021
DRAINAGE TYPE XXX XQX 34.F.022-025
DRAINAGE MONORAIL TYPE XQ 34.F.026-027

DRAINAGE MONORAIL TYPE XQX QXQ 34.F.028-029
DRAINAGE MONORAIL TYPE QXXQ 34.F.030-031
DRAINAGE FLAT BOTTOM 34.F.032-033
DECOMPRESSION VENTS 34.F.034
DRAINAGE VENT 34.F.035
CONNECTION CRIMP CORNER CLEAT 34.F.036-037
SCREW CORNER CONNECTION 34.F.038-039
CONNECTION CRIMP CORNER CLEAT MONORAIL 34.F.040-041
SCREW CORNER CONNECTION MONORAIL 34.F.042-043
ASSEMBLY OUTER FRAME 34.F.044-047
ASSEMBLY OUTER FRAME MONORAIL 34.F.048-049
ASSEMBLY OUTER FRAME 3-RAIL 34.F.050-051
ASSEMBLY OUTER FRAME 34.F.052-055
CORNER CONNECTION VENT 34.F.056-057
SCREW CORNER CONNECTION VENT 34.F.058-059
T-CONNECTIONS 34.F.060-061
T-BRACKET WITH SCREW AND/OR DRIVE PIN 34.F.062-063
T-CONNECTION MONORAIL 34.F.064-071
ASSEMBLY CLOSER WITH BRUSH 34.F.072
ASSEMBLY CLOSER WITH BRUSH MONORAIL 34.F.073
ASSEMBLY CLOSER WITH BRUSH 34.F.074
ASSEMBLY CLOSER WITH BRUSH MONORAIL 34.F.075
CLOSER WITH BRUSH 34.F.076-077
ASSEMBLY SLIDING VENT 34.F.078-081
PROCESSING MEETING STILE 4 DOOR 34.F.082-084
PROCESSING MEETING STILE 4 DOOR MONORAIL 34.F.085-087
RECESS BOTTOM PROFILE MONORAIL 34.F.088-089
EMBEDDING SAFETY LOCK 34.F.090
EMBEDDING SECURITY LOCK 4 DOORS 34.F.091
MILLING ACCESSORIES FOR LOCK 34.F.092-093
EMBEDDING 5 POINT LOCK 34.F.094-095
EMBEDDING BASIC SET LIFT AND SLIDING DOOR 34.F.096-097
EMBEDDING BASIC SET LIFT AND SLIDING DOOR 4 DOOF 34.F.098-099
EMBEDDING BASIC SET LIFT AND SLIDING DOOR 4 DOOR 34.F.100-101
BASIC SET AUTOMATIC LIFT AND SLIDING DOOR 34.F.102-105
EMBEDDING BASIC SET LIFT AND SLIDING DOOR 4 DOOF 34.F.106-107
ASSEMBLY DOOR HANDLE 34.F.108-109
ASSEMBLY DOOR HANDLE KABA 34.F.110-111
LOCK TABLE 34.F.112
MILLING ACCESSORIES FOR LOCK 34.F.113
BURGLAR PROTECTION 34.F.114-115
CONNECTION WITH OTHER SYSTEMS 34.F.116-119
BUFFER 34.F.120-121
BUILDING CONNECTION 34.F.122-129
CONNECTION PIECE 34.F.130-131
GLASS SUPPORTS 34.F.132
ASSEMBLY FIXING PIECE 34.F.133
ASSEMBLY 062.7927.04 / 062.8045.04 34.F.134-135
MONTAGE HULPPROFIEL INBRAAKWEREND 34.F.136-137
GLAZING TABLE 34.F.138-141
MAX. ADMISSIBLE SIZES VENTS 34.F.142-149
MAX. ADMISSIBLE LENGTHS VENTS 34.F.150
MAX. ADMISSIBLE SIZES VENTS 34.F.151-157
GENERAL 34.F.158-160

Accessories

OVERVIEW 34.G.001-007
CRIMP CORNER CLEATS 34.G.008
SCREW CORNER CLEATS 34.G.009
CORNER SUPPORTS 34.G.010
REBATE SUPPORTS 34.G.011-012
END PIECES 34.G.013
T-CONNECTION 34.G.014-015
T-BRACKET 34.G.016
T-BRACKETS 34.G.017-018
SEALING T-BRACKET 34.G.019
T-BRACKET 34.G.020
VARIABLE T-BRACKET 34.G.021
DOOR HANDLES 34.G.022-029
HANDRAIL 34.G.030
DOOR HANDLES 34.G.031
BURGLAR PROTECTION 34.G.032
LOCKS LIFT AND SLIDING DOOR 34.G.033
HOOK LOCKS 34.G.034
RECEIVERS 34.G.035
CYLINDER 34.G.036
RECEIVERS 34.G.037
BASIC SET LIFT AND SLIDING DOOR 34.G.038
LOCKS LIFT AND SLIDING DOOR 34.G.039
LOCKS 34.G.040
GLASS SUPPORT 34.G.041
ROLLER 34.G.042
BUFFER 34.G.043
GENERAL ACCESSORIES 34.G.044-047
GLAZING GASKETS 34.G.048
GLAZING GASKET 34.G.049
GLAZING GASKETS 34.G.050-052
GASKETS 34.G.053-056
END PIECES 34.G.057-059
BRUSHES 34.G.060
INSULATING FILLING PIECE 34.G.061
ANCHORINGS 34.G.062-063
MISCELLANEOUS 34.G.064-074
FIXINGS 34.G.075-089
SLIDING DOOR KIT 34.G.089_01.001
BASIC SET AUTOMATIC LIFT AND SLIDING DOOR 34.G.089_01.002-091
BORING JIGS AND PUNCH TOOLS 34.G.092
BORING JIG T-CONNECTION ADJUSTABLE 34.G.093
BORING JIG T-CONNECTION 34.G.094
BORING JIG DRAINAGE 34.G.095
BORING JIG SCREW CONNECTION 34.G.096
BORING JIG 34.G.097
BORING JIG SCREW CORNER CLEAT 34.G.098
PUNCH UNIT CORNER AND T-CONNECTION 34.G.099-100
PUNCH UNIT T-BRACKET 34.G.101
PUNCH UNIT DRAINAGE 34.G.102
PUNCH UNIT MEETING SECTION 34.G.103
PUNCH UNIT SCREW CONNECTION 34.G.104
STENCIL PLATE FOR 095.A700.00 34.G.105
STENCIL PLATE FOR 095.B300.00 34.G.106



PRESS BLOCK FOR 095.H800.00
PRESSBLOCKS
KNIVES
PRESS BLOCK FOR 095.B500.00
KNIVES FOR 095.B500.00

34.G.107
34.G.108
34.G.109
34.G.110-111
34.G.112-113



Inhalt

INHALTSANGABE 34.001-008

Allgemeine Information

ZEICHENERKLÄRUNG 34.A.001-007
UEBERSICHT PRUEFBERICHTE 34.A.008-010

Allgemeine Information System

VERARBEITUNGSVORSCHRIFTEN 34.B.001-004

Profile

PROFILUEBERSICHT 34.C.001-007
BLENDRAHMEN 34.C.008-009
BLENDRAHMEN 34.C.010
BLENDRAHMEN EINBRUCHHEMMEND 34.C.011
BLENDRAHMEN 34.C.012
BLENDRAHMEN MONORAIL 34.C.013-014
ABDECKPROFIL BLENDRAHMEN MONORAIL 34.C.015
BLENDRAHMEN 3-RAIL 34.C.016-018
BLENDRAHMEN MONORAIL 34.C.019-022
ABDECKPROFIL BLENDRAHMEN MONORAIL FLUEGEL 34.C.023
FLUEGEL 34.C.024
FLUEGEL EINBRUCHHEMMEND 34.C.025
ZUSATZPROFILE FLUEGEL 34.C.026-027
VERSTAERKUNGSPROFIL FLUEGEL 34.C.028
VERSTAERKUNGSPROFIL FLUEGEL 34.C.029
SPROSSEN 34.C.030-033
RIEGEL 34.C.034
WECHSELPROFIL 34.C.035
GLASLEISTEN 34.C.036-037
GLASLEISTEN EINBRUCHHEMMEND 34.C.038
ROLLADENFUHRUNGEN 34.C.039-041
AUSDEHNUNGSPROFIL 34.C.042
KUPPLUNGSPROFIL 34.C.043-044
AUSFUHRUNGSPROFIL 34.C.045
ZUSATZPROFILE 34.C.046
AUSFUHRUNGSPROFIL 34.C.047
WECHSELPROFIL 34.C.048
ABDECKKAPPE ANTRIEB 34.C.049
BLENDRAHMEN 34.C.050
BEFESTIGUNGSPROFIL REYNACONNECT 34.C.051-052

Werkzeichnungen

UEBERSICHT 34.E.001
UEBERSICHT ISOLIERVARIANTEN 2-RAIL/3-RAIL 34.E.002-005
UEBERSICHT ISOLIERVARIANTEN MONORAIL 34.E.006-009
UEBERSICHT ISOLIERVARIANTEN 2-RAIL/3-RAIL 34.E.010-013
UEBERSICHT ISOLIERVARIANTEN MONORAIL 34.E.014-019
UEBERSICHT ISOLIERVARIANTEN FLAT-BOTTOM 34.E.020-021
UEBERSICHT ISOLIERVARIANTEN 34.E.022-023
UEBERSICHT ISOLIERVARIANTEN MONORAIL MINERGIE 34.E.024-027
UEBERSICHT 34.E.028-031
2-RAIL XQ 34.E.032-037
2-RAIL XQ 34.E.038-043
2-RAIL QXX 34.E.044-049
2-RAIL QXXQ 34.E.050-055
2-RAIL OXXO 34.E.056-061
MONORAIL XQ 34.E.062-069
MONORAIL QXX 34.E.070-075
MONORAIL QXXQ 34.E.076-081
3-RAIL XXQ 34.E.082-087
3-RAIL XXO 34.E.088-093
2-RAIL XQ 34.E.094-101
2-RAIL XQ FLAT BOTTOM 34.E.102-107
2-RAIL XX 34.E.108-113
2-RAIL QXX 34.E.114-119
2-RAIL QXXQ 34.E.120-125
2-RAIL XXXX 34.E.126-131
2-RAIL QXQ 34.E.132-137
MONORAIL XQ 34.E.138-145
MONORAIL QXX 34.E.146-151
MONORAIL QXXQ 34.E.152-157
3-RAIL XXQ 34.E.158-163
3-RAIL XXX 34.E.164-169
AUTOMATISCHE HEBESCHIEBETUER 34.E.170-175
MONORAIL XQ 34.E.176-183
MONORAIL QXQ 34.E.184-189
MONORAIL QXX 34.E.190-195
MONORAIL QXXQ 34.E.196-201
2-RAIL XQ EINBRUCHHEMMEND 34.E.202-205
2-RAIL XQ 34.E.206-208
2-RAIL 34.E.209
2-RAIL XQ 34.E.210-213
2-RAIL QXXQ 34.E.214

Montagezeichnungen

ENTWAESSERUNG TYP XQ XO QXX 34.F.001-003
ENTWAESSERUNG TYP QXQ QXXQ OXXO 34.F.004-005
ENTWAESSERUNG TYP XQ XX QXX 34.F.006-007
ENTWAESSERUNG TYP QXQ QXXQ OXXO 34.F.008-009
ENTWAESSERUNG MONORAIL TYP XQ 34.F.010-011
ENTWAESSERUNG MONORAIL TYP QXX 34.F.012-013
ENTWAESSERUNG MONORAIL TYP QXXQ 34.F.014-015
ENTWAESSERUNG MONORAIL TYP XQ 34.F.016-017
ENTWAESSERUNG MONORAIL TYP QXX 34.F.018-019
ENTWAESSERUNG MONORAIL TYP QXXQ 34.F.020-021
ENTWAESSERUNG TYP XXX QXX 34.F.022-025
ENTWAESSERUNG MONORAIL TYP XQ 34.F.026-027

ENTWAESSERUNG MONORAIL TYP QXX QXX 34.F.028-029
ENTWAESSERUNG MONORAIL TYP QXXQ 34.F.030-031
ENTWAESSERUNG FLAT BOTTOM 34.F.032-033
DEKOMPRESSIION FLUEGELS 34.F.034
ENTWAESSERUNG FLUEGEL 34.F.035
VERBINDUNG PRESSECKWINKEL 34.F.036-037
SCHRAUBECKWINKELVERBINDUNG 34.F.038-039
VERBINDUNG PRESSECKWINKEL MONORAIL 34.F.040-041
SCHRAUBECKWINKELVERBINDUNG MONORAIL 34.F.042-043
MONTAGE BLENDRAHMEN 34.F.044-047
MONTAGE BLENDRAHMEN MONORAIL 34.F.048-049
MONTAGE BLENDRAHMEN 3-RAIL 34.F.050-051
MONTAGE BLENDRAHMEN 34.F.052-055
ECKVERBINDUNG FLUEGEL 34.F.056-057
SCHRAUBECKWINKELVERBINDUNG FLUEGEL 34.F.058-059
T-VERBINDUNGEN 34.F.060-061
T-VERBINDER MIT SCHRAUBE UND/ODER STIFT 34.F.062-063
T-VERBINDUNG MONORAIL 34.F.064-071
MONTAGE ABDICHTUNG MIT BUERSTE 34.F.072
MONTAGE ABDICHTUNG MIT BUERSTE MONORAIL 34.F.073
MONTAGE ABDICHTUNG MIT BUERSTE 34.F.074
MONTAGE ABDICHTUNG MIT BUERSTE MONORAIL 34.F.075
ABDICHTUNG MIT BUERSTE 34.F.076-077
MONTAGE SCHIEBEFLUEGEL 34.F.078-081
BEARBEITEN STULPPROFIL TUERFLUEGEL 34.F.082-084
BEARBEITEN STULPPROFIL TUERFLUEGEL MONORAIL 34.F.085-087
AUSSPARUNG BODENPROFIL MONORAIL 34.F.088-089
EINBAU PZ SCHLOSS E 34.F.090
EINBAU PZ-SCHLOSS 4-SCHLAG 34.F.091
AUSFRAESUNG BESCHLAG FUER SCHLOSS 34.F.092-093
EINBAU 5-FACHVERRIEGELUNG 34.F.094-095
EINBAU GRUNDKARTON HEBESCHIEBETUER 34.F.096-097
EINBAU GRUNDKARTON HEBESCHIEBETUER 4-SCHLAG 34.F.098-099
EINBAU GRUNDKARTON HEBESCHIEBETUER 4-SCHLAG I 34.F.100-101
GRUNDKARTON AUTOMATISCHE HEBESCHIEBETUER 34.F.102-105
EINBAU GRUNDKARTON HEBESCHIEBETUER 4-SCHLAG 34.F.106-107
MONTAGE TUERDRUECKER 34.F.108-109
MONTAGE TUERDRUECKER KABA 34.F.110-111
UEBERSICHT SCHLOESSER 34.F.112
AUSFRAESUNG BESCHLAG FUER SCHLOSS 34.F.113
EINBRUCHHEMMEND 34.F.114-115
VERBINDUNGEN MIT ANDEREN SYSTEMEN 34.F.116-119
STOPPER 34.F.120-121
BAUANSCHLUSS 34.F.122-129
KUPPLUNGSSTUECK 34.F.130-131
KLOTZBRUECKEN 34.F.132
MONTAGE BEFESTIGUNGSKLOTZ 34.F.133
MONTAGE 062.7927.04 / 062.8045.04 34.F.134-135
MONTAGE ZUSATZPROFILE EINBRUCHHEMMEND 34.F.136-137
VERGLASUNGSTABELLE 34.F.138-141
MAX. ZULAESSIGE ABMESSUNGEN FLUEGELS 34.F.142-149
MAX. ZULAESSIGE LAENGEN FLUEGELS 34.F.150
MAX. ZULAESSIGE ABMESSUNGEN FLUEGELS 34.F.151-157
ALLGEMEIN 34.F.158-160







Zubehör







UEBERSICHT 34.G.001-007
PRESSECKWINKEL 34.G.008
SCHRAUBECKWINKEL 34.G.009
FUELLECKWINKEL 34.G.010
ECKWINKEL GLASANSCHLAG 34.G.011-012
ENDKAPPEN 34.G.013
T-VERBINDUNG 34.G.014-015
T-VERBINDER 34.G.016
T-VERBINDER 34.G.017-018
ABDICHTUNG T-VERBINDER 34.G.019
T-VERBINDER 34.G.020
VARIABELER T-VERBINDER 34.G.021
TUERDRUECKER 34.G.022-029
HANDLAUF 34.G.030
TUERDRUECKER 34.G.031
EINBRUCHHEMMEND 34.G.032
SCHLOESSER HEBESCHIEBETUER 34.G.033
HAKENSCHLOSS 34.G.034
SCHLIESSBLECHE 34.G.035
ZYLINDER 34.G.036
SCHLIESSBLECHE 34.G.037
GRUNDKARTON HEBESCHIEBETUER 34.G.038
SCHLOESSER HEBESCHIEBETUER 34.G.039
SCHLOESSER 34.G.040
GLASAUFLEGEPROFIL 34.G.041
LAUFRAD 34.G.042
STOPPER 34.G.043
ALLGEMEINES ZUBEHOER 34.G.044-047
VERGLASUNGSDICHTUNGEN 34.G.048
VERGLASUNGSDICHTUNG 34.G.049
VERGLASUNGSDICHTUNGEN 34.G.050-052
DICHTUNGEN 34.G.053-056
ABDICHTUNGEN 34.G.057-059
BUESTENDICHTUNGEN 34.G.060
ISOLIERENDES FUELLSTUECK 34.G.061
VERANKERUNGEN 34.G.062-063
DIVERSE 34.G.064-074
BEFESTIGUNGSMITTEL 34.G.075-089
SCHIEBETUER 34.G.089_01.001
GRUNDKARTON AUTOMATISCHE HEBESCHIEBETUER 34.G.089_01.002-091
BOHRLEHREN UND STANZWERKZEUGE 34.G.092
BOHRLEHRE T-VERBINDUNG VERSTELLBAR 34.G.093
BOHRLEHRE T-VERBINDUNG 34.G.094
BOHRLEHRE ENTWAESSERUNG 34.G.095
BOHRLEHRE VERSCHRAUBUNG 34.G.096
BOHRLEHRE 34.G.097
BOHRLEHRE SCHRAUBECKWINKEL 34.G.098
STANZEINHEIT ECK- UND T-VERBINDUNG 34.G.099-100
STANZEINHEIT T-VERBINDUNG 34.G.101
STANZEINHEIT ENTWAESSERUNG 34.G.102
STANZEINHEIT WECHSELPROFIL 34.G.103
STANZEINHEIT VERSCHRAUBUNG 34.G.104
SCHABLONE FEUR 095.A700.00 34.G.105
SCHABLONE FEUR 095.B300.00 34.G.106









PRESSBLOCK FUER 095.H800.00
PRESS BLOCHE
MESSER
PRESSBLOCK FUER 095.B500.00
MESSER FUER 095.B500.00

34.G.107
34.G.108
34.G.109
34.G.110-111
34.G.112-113

					
34.A.001	11/2011	D0071480	34.E.010	12/2011	D0078785
34.A.002	11/2011	D0071481	34.E.012	12/2011	D0078786
34.A.003	11/2011	D0071482	34.E.014	12/2011	D0083931
34.A.004	11/2011	D0071483	34.E.016	12/2011	D0090017
34.A.005	11/2011	D0071484	34.E.018	12/2011	D0090327
34.A.006	11/2011	D0071485	34.E.020	12/2011	D0090329
34.A.007	11/2011	D0071486	34.E.022	12/2011	D0090111
34.A.008	11/2011	D0076659	34.E.024	12/2011	D0083932
34.A.010	12/2011		34.E.026	12/2011	D0090335
34.B.001	11/2011	D0056489	34.E.028	11/2011	D0084657
34.B.002	11/2011	D0056490	34.E.030	12/2011	D0084659
34.B.003	11/2011	D0056491	34.E.032	11/2011	D0013911
34.B.004	11/2011	D0056487	34.E.034	11/2011	D0013912
34.C.001	11/2011	D0078698	34.E.036	11/2011	D0090782
34.C.002	11/2011	D0078700	34.E.038	11/2011	D0013913
34.C.003	11/2011	D0078745	34.E.040	11/2011	D0013914
34.C.004	11/2011	D0078746	34.E.042	11/2011	D0084635
34.C.005	11/2011	D0013874	34.E.044	11/2011	D0013915
34.C.006	11/2011	D0078697	34.E.046	11/2011	D0013916
34.C.007	11/2011	D0084686	34.E.048	11/2011	D0084611
34.C.008	11/2011	D0013843	34.E.050	11/2011	D0013917
34.C.009	11/2011	D0013844	34.E.052	11/2011	D0013918
34.C.010	11/2011	D0013845	34.E.054	11/2011	D0013919
34.C.011	11/2011	D0013846	34.E.056	11/2011	D0013920
34.C.012	11/2011	D0013847	34.E.058	11/2011	D0013921
34.C.013	11/2011	D0013848	34.E.060	11/2011	D0013922
34.C.014	11/2011	D0013849	34.E.062	11/2011	D0013923
34.C.015	11/2011	D0013850	34.E.064	11/2011	D0013924
34.C.016	11/2011	D0044533	34.E.066	11/2011	D0090795
34.C.017	11/2011	D0044575	34.E.068	11/2011	D0090577
34.C.018	11/2011	D0044579	34.E.070	11/2011	D0013925
34.C.019	12/2011	D0084595	34.E.072	11/2011	D0013926
34.C.020	12/2011	D0084596	34.E.074	12/2011	D0084629
34.C.021	12/2011	D0084597	34.E.076	11/2011	D0013927
34.C.022	12/2011	D0084598	34.E.078	11/2011	D0013928
34.C.023	12/2011	D0084601	34.E.080	11/2011	D0013929
34.C.024	11/2011	D0013851	34.E.082	11/2011	D0084693
34.C.025	11/2011	D0013852	34.E.084	11/2011	D0084694
34.C.026	11/2011	D0013854	34.E.086	11/2011	D0084695
34.C.027	11/2011	D0013853	34.E.088	11/2011	D0045159
34.C.028	11/2011	D0013855	34.E.090	11/2011	D0045149
34.C.029	11/2011	D0090318	34.E.092	11/2011	D0045153
34.C.030	11/2011	D0013856	34.E.094	11/2011	D0013930
34.C.031	11/2011	D0013857	34.E.096	11/2011	D0013931
34.C.032	11/2011	D0075003	34.E.098	11/2011	D0090798
34.C.033	11/2011	D0013858	34.E.100	11/2011	D0078769
34.C.034	12/2011	D0084599	34.E.102	11/2011	D0074742
34.C.035	11/2011	D0046576	34.E.104	11/2011	D0074743
34.C.036	11/2011	D0044306	34.E.106	11/2011	D0084630
34.C.037	11/2011	D0083806	34.E.108	11/2011	D0013932
34.C.038	11/2011	D0013859	34.E.110	11/2011	D0013933
34.C.039	11/2011	D0013865	34.E.112	11/2011	D0044934
34.C.040	11/2011	D0013864	34.E.114	11/2011	D0013934
34.C.041	11/2011	D0090319	34.E.116	11/2011	D0013935
34.C.042	11/2011	D0074999	34.E.118	11/2011	D0044956
34.C.043	11/2011	D0075000	34.E.120	11/2011	D0013936
34.C.044	11/2011	D0013866	34.E.122	11/2011	D0013937
34.C.045	11/2011	D0013867	34.E.124	11/2011	D0013938
34.C.046	11/2011	D0013868	34.E.126	11/2011	D0013939
34.C.047	11/2011	D0013869	34.E.128	11/2011	D0013940
34.C.048	12/2011	D0084600	34.E.130	11/2011	D0013941
34.C.049	11/2011	D0059657	34.E.132	11/2011	D0046860
34.C.050	11/2011	D0074761	34.E.134	11/2011	D0046869
34.C.051	11/2011	D0084234	34.E.136	11/2011	D0084631
34.C.052	12/2011		34.E.138	11/2011	D0013942
34.E.001	12/2011		34.E.140	11/2011	D0013943
34.E.002	12/2011	D0078772	34.E.142	11/2011	D0090800
34.E.004	12/2011	D0078774	34.E.144	11/2011	D0090570
34.E.006	12/2011	D0083930	34.E.146	11/2011	D0013944
34.E.008	12/2011	D0090014	34.E.148	11/2011	D0013945

					
34.E.150	11/2011	D0045123	34.F.074	11/2011	D0090515
34.E.152	11/2011	D0013946	34.F.076	11/2011	D0084312
34.E.154	11/2011	D0013947	34.F.078	11/2011	D0079350
34.E.156	11/2011	D0013948	34.F.080	11/2011	D0013962
34.E.158	11/2011	D0084696	34.F.082	11/2011	D0013972
34.E.160	11/2011	D0084697	34.F.084	11/2011	D0013973
34.E.162	11/2011	D0084698	34.F.086	12/2011	D0090587
34.E.164	11/2011	D0044654	34.F.088	12/2011	D0075115
34.E.166	11/2011	D0044639	34.F.090	11/2011	D0013963
34.E.168	11/2011	D0045164	34.F.092	12/2011	D0084431
34.E.170	11/2011	D0059817	34.F.094	12/2011	D0079360
34.E.172	11/2011	D0059815	34.F.096	11/2011	D0013966
34.E.174	11/2011	D0084633	34.F.098	11/2011	D0013967
34.E.176	12/2011	D0083819	34.F.100	11/2011	D0075276
34.E.178	12/2011	D0083823	34.F.102	11/2011	D0059816
34.E.180	12/2011	D0090801	34.F.104	11/2011	D0059814
34.E.182	12/2011	D0083962	34.F.106	11/2011	D0013968
34.E.184	11/2011	D0083824	34.F.108	11/2011	D0013969
34.E.186	12/2011	D0083827	34.F.110	11/2011	D0075075
34.E.188	12/2011	D0083969	34.F.112	11/2011	D0075223
34.E.190	11/2011	D0083971	34.F.114	11/2011	D0013970
34.E.192	12/2011	D0083972	34.F.116	11/2011	D0013971
34.E.194	12/2011	D0083974	34.F.118	11/2011	D0079442
34.E.196	12/2011	D0083829	34.F.120	11/2011	D0013974
34.E.198	12/2011	D0083832	34.F.122	11/2011	D0084159
34.E.200	12/2011	D0083834	34.F.124	11/2011	D0084190
34.E.202	11/2011	D0084701	34.F.126	11/2011	D0084192
34.E.204	11/2011	D0084702	34.F.128	11/2011	D0091018
34.E.206	11/2011	D0090894	34.F.130	11/2011	D0074908
34.E.208	11/2011	D0090900	34.F.132	11/2011	D0075052
34.E.210	11/2011	D0090906	34.F.134	11/2011	D0075263
34.E.212	11/2011	D0090907	34.F.136	11/2011	D0084711
34.E.214	12/2011		34.F.138	11/2011	D0078796
34.F.001	12/2011		34.F.140	11/2011	D0090530
34.F.002	11/2011	D0013977	34.F.142	11/2011	D0013987
34.F.004	11/2011	D0013978	34.F.144	11/2011	D0090628
34.F.006	11/2011	D0013979	34.F.146	11/2011	D0013988
34.F.008	11/2011	D0013980	34.F.148	11/2011	D0013990
34.F.010	11/2011	D0013981	34.F.150	11/2011	D0013993
34.F.012	11/2011	D0013982	34.F.152	11/2011	D0013995
34.F.014	11/2011	D0013983	34.F.154	11/2011	D0013997
34.F.016	11/2011	D0013984	34.F.156	11/2011	D0090627
34.F.018	11/2011	D0013985	34.F.158	11/2011	D0072459
34.F.020	11/2011	D0013986	34.F.160	12/2011	
34.F.022	11/2011	D0046849	34.G.001	12/2011	D0075500
34.F.024	11/2011	D0046856	34.G.002	12/2011	D0075501
34.F.026	12/2011	D0084307	34.G.003	12/2011	D0075502
34.F.028	12/2011	D0084308	34.G.004	12/2011	D0075503
34.F.030	12/2011	D0084311	34.G.005	12/2011	D0075504
34.F.032	11/2011	D0079541	34.G.006	12/2011	D0075505
34.F.034	12/2011	D0013975	34.G.007	12/2011	D0091024
34.F.036	11/2011	D0013951	34.G.008	11/2011	D0014004
34.F.038	11/2011	D0013952	34.G.009	11/2011	D0014005
34.F.040	11/2011	D0013953	34.G.010	11/2011	D0014006
34.F.042	11/2011	D0013954	34.G.011	11/2011	D0084683
34.F.044	11/2011	D0013955	34.G.012	11/2011	D0014007
34.F.046	11/2011	D0079791	34.G.013	11/2011	D0045257
34.F.048	11/2011	D0013956	34.G.014	11/2011	D0014008
34.F.050	11/2011	D0046824	34.G.015	11/2011	D0014009
34.F.052	12/2011	D0084239	34.G.016	11/2011	D0014010
34.F.054	12/2011	D0084298	34.G.017	11/2011	D0090450
34.F.056	11/2011	D0013957	34.G.018	11/2011	D0090451
34.F.058	11/2011	D0090470	34.G.019	11/2011	D0014013
34.F.060	11/2011	D0013958	34.G.020	11/2011	D0079657
34.F.062	11/2011	D0013959	34.G.021	11/2011	D0090453
34.F.064	11/2011	D0013960	34.G.022	11/2011	D0014019
34.F.066	11/2011	D0013961	34.G.023	11/2011	D0084602
34.F.068	12/2011	D0084305	34.G.024	11/2011	D0084603
34.F.070	12/2011	D0090511	34.G.025	11/2011	D0084604
34.F.072	11/2011	D0075233	34.G.026	11/2011	D0014017

					
34.G.027	11/2011	D0014018	34.G.095	11/2011	D0014062
34.G.028	11/2011	D0075081	34.G.096	11/2011	D0079753
34.G.029	11/2011	D0079664	34.G.097	11/2011	D0059656
34.G.030	11/2011	D0014020	34.G.098	11/2011	D0014063
34.G.031	11/2011	D0090576	34.G.099	11/2011	D0074794
34.G.032	11/2011	D0014022	34.G.100	11/2011	D0074792
34.G.033	11/2011	D0075082	34.G.101	11/2011	D0074793
34.G.034	11/2011	D0014023	34.G.102	11/2011	D0084692
34.G.035	11/2011	D0014024	34.G.103	11/2011	D0075005
34.G.036	11/2011	D0014025	34.G.104	11/2011	D0090229
34.G.037	11/2011	D0014026	34.G.105	11/2011	D0046335
34.G.038	11/2011	D0014027	34.G.106	11/2011	D0079756
34.G.039	11/2011	D0014028	34.G.107	11/2011	D0046333
34.G.040	11/2011	D0075261	34.G.108	11/2011	D0046332
34.G.041	11/2011	D0014029	34.G.109	11/2011	D0046330
34.G.042	11/2011	D0014030	34.G.110	11/2011	D0046323
34.G.043	11/2011	D0014031	34.G.111	11/2011	D0046324
34.G.044	11/2011	D0014032	34.G.112	11/2011	D0046322
34.G.045	11/2011	D0014033	34.G.113	11/2011	D0046328
34.G.046	11/2011	D0014034	34.G.114	11/2011	D0084682
34.G.047	11/2011	D0014035	34.G.115	11/2011	D0090231
34.G.048	11/2011	D0014036	34.G.116	12/2011	
34.G.049	11/2011	D0090480	34.001	12/2011	
34.G.050	11/2011	D0014037	34.003	12/2011	
34.G.051	11/2011	D0045280	34.005	12/2011	
34.G.052	11/2011	D0090489	34.007	12/2011	
34.G.053	11/2011	D0014038			
34.G.054	11/2011	D0090492			
34.G.055	12/2011	D0045283			
34.G.056	12/2011	D0090238			
34.G.057	11/2011	D0014039			
34.G.058	11/2011	D0014040			
34.G.059	11/2011	D0079746			
34.G.060	11/2011	D0014041			
34.G.061	12/2011	D0084719			
34.G.062	11/2011	D0014042			
34.G.063	11/2011	D0090239			
34.G.064	11/2011	D0014043			
34.G.065	11/2011	D0014044			
34.G.066	11/2011	D0014045			
34.G.067	11/2011	D0014046			
34.G.068	11/2011	D0014047			
34.G.069	11/2011	D0014048			
34.G.070	11/2011	D0014049			
34.G.071	11/2011	D0084678			
34.G.072	11/2011	D0084679			
34.G.073	11/2011	D0084680			
34.G.074	11/2011	D0084681			
34.G.075	11/2011	D0068363			
34.G.076	11/2011	D0068364			
34.G.077	11/2011	D0068365			
34.G.078	11/2011	D0068366			
34.G.079	11/2011	D0068368			
34.G.080	11/2011	D0068367			
34.G.081	11/2011	D0068369			
34.G.082	11/2011	D0068370			
34.G.083	11/2011	D0068371			
34.G.084	11/2011	D0068372			
34.G.085	11/2011	D0068373			
34.G.086	11/2011	D0068374			
34.G.087	11/2011	D0068376			
34.G.088	11/2011	D0068377			
34.G.089	11/2011	D0075642			
34.G.089_01.001	12/2011	D0091336			
34.G.089_01.002	12/2011				
34.G.090	11/2011	D0059648			
34.G.091	11/2011	D0059652			
34.G.092	11/2011	D0014058			
34.G.093	11/2011	D0014059			
34.G.094	11/2011	D0014061			

CP 155
CP 155-LS

INHOUDSTAFEL
TABLE DES MATIERES
TABLE OF CONTENTS
INHALTSANGABE



A



Algemene informatie

Généralités





































General Information































Allgemeine Information



































	Profiel Profilé Profile Profil	Perfil Profil Profil		Verstek Onglet Mitre Gehrung	Inglete Polaczenie katowe Taglio
	Anodisatie- of lakoppervlakte Surface anodisée ou laquée Anodizing or coating surface Eloxierte oder lackierte Oberfläche	Superficie anodizada o lacada Powierzchnia anodowana lub malowana Superficie anodizzata o verniciata	#	Aantal Nombre Number Anzahl	Número Ilość Numero
	Polijsoppervlakte Surface à polir Polishing surface Polieroberfläche	Superficie pulida Powierzchnia polerowana Superficie lucidata		Zie pagina Voir page See page Siehe Seite	Ver página Patrz stronę Vedi pagina
	Lengte Longueur Length Länge	Longitud Długość Lunghezza		Type toebehoren Type accessoires Type accessories Typ Zubehör	Tipos de accesorios Rodzaj okuc Tipo di accessorio
	Afmetingen Dimensions Dimensions Abmessungen	Dimensiones Wymiary Dimensioni		Glasmaten Dimensions vitres Glass sizes Glasmasse	Dimensiones de los vidrios Wymiary szyby Dimensioni del vetro
	Toepassing Application Application Anwendung	Aplicación Zastosowanie Utilizzo		Toepassing Application Utilization Anwendung	Aplicación Zastosowanie Riferimenti
	Bevestigingsmiddelen Moyens de fixation Fixations Befestigungsmittel	Fijación Mocowanie Fissaggio		Asymmetrisch profiel Profilé asymétrique Asymmetrical profile Asymmetrisches Profil	Perfil asimétrico Profil niesymetryczny Profilo asimmetrico
	Schroeven niet meegeleverd Fourniture sans vis Delivered without screws Lieferung ohne Schrauben	Entregado sin tornillos Dostarczane bez wkrętów Consegnato senza viti		Pagina Page Page Seite	Página Strona Pagina
	Montagevolgorde Ordre de montage The order of assembly Montagereihenfolge	Orden de montaje Kolejność montażu Ordine di montaggio		Laatste editie Dernière édition Last edition Letzte Edition	Edición Poprzednie wydanie Ultima edizione
	Dichtingsmiddel Matière d'étanchéité Sealing agent Abdichtungsmittel	Agente sellante Masa uszczelniająca Siliconatura		Vorige blz Page précédente Previous page Vorige Seite	Página siguiente Poprzednia strona Pagina precedente
	Verlijmen Coller Glue Verkleben	Collado Klej Colla		Verstevigingsprofiel Profil de renforcement Reinforcement profile Verstärkungsprofil	Perfil refuerzo Profil wzmacniający Profilo di rinforzo
	Vulcaniseerlijm Colle vulcanisante Vulcanizing glue Vulkanisierkleber	Vulcanizante Klej wulkanizacyjny Colla vulcanizzante		Links van buiten gezien Gauche vue extérieur Left seen from outside Links Aussehen	Vista izquierda desde el exterior Na lewo widok od zewnątrz Sinistro visto da fuori
	Referentiemaat Dimension de référence Reference dimension Referenzmass	Dimension de referencia Punkt odniesienia wymiarowania Dimensioni di riferimento		Rechts van buiten gezien Droite vue extérieur Right seen from outside Rechts Aussehen	Vista derecha desde el exterior Na prawa widok od zewnątrz Destro visto da fuori
	Merkteken Marquage Mark Merkmale	Indicación Znak Contrassegno		Reynaprotector Reynaprotector Reynaprotector Reynaprotector	Reynaprotector Reynaprotector Reynaprotector Reynaprotector
	Struktureel gelijmd glaswerk Vitrage extérieur collé Structural sealing glazing UV-beständiger Scheibenrandverbund	Sellado acristalado estructural Szyba klejona spoiwem konstrukcyjnym Siliconatura vetro strutturale		Kleur buitenschaal (e) eerst aangeven in geval van bicolor (.69) En cas de bicolor (.69) il faut indiquer d'abord la couleur du profilé extérieur (e) For bicolor profiles (.69) first of all one should indicate the colour of the outer profile (e) Falls zweifarbig (.69) soll man erst die Farbe des Aussenprofils (e) angeben	Para perfil en bicolor (.69) debe indicarse primero el color del perfil externo (e) Dla profili dwukolorowych (.69) w pierwszej kolejności powinny być wskazany kolor zewnętrznej strony profilu (e) Nej profili bicolore (.69) prima di tutto indicare il colore del profilo esterno (e)
	Primaire zichtzijde van een profiel Côté visible primaire d'un profilé Primary visible side of a profile Primäre sichtbare Seite eines Profils	Cara vista principal del perfil Główna widoczna powierzchnia profilu Primo lato visibile di un profilo			
	Secundaire zichtzijde van een profiel Côté visible secondaire d'un profilé Secondary visible side of a profile Sekund. sichtbare Seite eines Profils	Cara vista secundaria del perfil Drugorzędna widoczna powierzchnia profilu Secondo lato visibile di un profilo			























	Inbraakwerend Anti-vol Burglar proof Einbruchhemmend	Protección anti- robo Antywłamaniowe Antiscasso		Pershoekverbinding Equerre à serti Crimp corner cleat Presseckverbinder	Escuadra de ensamblar Naroznik zaciskany Squadrette a cianfrinare
	Basisveiligheid Sécurité de base Basic safety Basissicherheit	Seguridad básica Antywłamaniowosc podstawowa Antiscasso base		Hoekverbinding met schroefhoek (* enkel voor klembaar beslag Equerre à blocage (* seulement pour accessoires encastrables Corner cleat with screw (* only for clamping accessories Eckverbinder mit Spannschraube (* nur für klemmbaren Beschlag	Escuadra de atornillar (* solo para accesorios apretables Naroznik skrecany (* tylko dla akcesoriow zatrzaskiwanych Squadrette ad avvitare (* solo per accessori a scatto
 ENV	Testen uitgevoerd volgens norm DIN V ENV 1627 Essais effectués par conformément la norme DIN V ENV 1627 Tests carried out according to standard DIN V ENV 1627 Einbruchhemmende Prüfungen gemäß Norm DIN V ENV 1627	Ensayos realizados según norma DIN V ENV 1627 Badania wykonane według normy DIN V ENV 1627 Antiscasso secondo DIN V ENV 1627		T-verbinding met schroef Jonction-T avec vis T-bracket with screw T-Verbinder mit Schraube	Topo de union con tornillo Lacznik teowy skrecany Giunti con viti
 NEN	Testen uitgevoerd volgens norm NEN 5096 + ENV 1627 Essais effectués par conformément la norme NEN 5096 + ENV 1627 Tests carried out according to standard NEN 5096 + ENV 1627 Einbruchhemmende Prüfungen gemäß Norm NEN5096 + ENV1627	Ensayos realizados según norma NEN 5096 + ENV 1627 Badania wykonane norm NEN 5098 + ENV 1627 Antiscasso secondo NEN 5098 + ENV 1627		T-verbinding met schroef voor buitendraaiend raam Jonction-T avec vis pour fenêtre ouvrant vers l'ext. T-bracket with screw outside opening window T-Verbinder mit Schraube ausßen öffnendes Fenster	Topo Unión con tornillo apertura exterior Lacznik teowy skrecany do okien otwieranych na zewnatrz Cavallotti conuiti ap est.
	Testen uitgevoerd door instituut IBS (Oostenrijk) volgens norm Ö B 3800/3850 Essais effectués par IBS(Autriche) conformément la norme Ö B 3800/3850 Tests carried out by IBS (Austria) according to standard Ö B 3800/3850 Brandschutzprüfungen durch- geführt beim IBS (Österreich) gemäß Norm Ö B 3800/3850	Ensayos hechos por IBS (Austria) según la estandard Ö B 3800/3850 Badania wykonane przez IBS (Austria) według norm Ö B 3800/3850 Testato presso IBS (Austria) IBS secondo Ö B 3800/3850		Vulhoek Equerre de remplissage Corner support Fülleckwinkel	Escuadra de relleno Wspornik narozny Squadrette di riempimento
	Testen uitgevoerd door instituut TNO (Nederland) volgens norm NEN 6069:1997 Essais effectués par TNO (Hollande) conformément la norme NEN 6069:1997 Tests carried out by TNO (The Netherlands) according to standard NEN 6069/1997 Brandschutzprüfungen durch- geführt beim IBS (Österreich) gemäß Norm Ö B 3800/3850	Ensayos realizados fuera por TNO(Holanda) según norma NEN 6069/1977 Badania wykonane przez TNO (Holandia) według norm NEN 6069/1977 Testato presso TNO (Paesi Bassi) secondo NEN 6069/1977		Verstelbare schroefhoek Equerre à visser réglable Adjustable screw corner cleat Verstellbarer Schraubewinkel	Escuadra de atornillar regulable Katowy naroznik skrecany Squadrette ad avvitare regolabili
	Testen uitgevoerd door instituut IBS (Österreich) volgens norm Ö B 3800/3850	Ensayos realizados por IBS (Austria) según la estandard Ö B 3800/3850 Badania wykonane przez IBS (Austria) według norm Ö B 3800/3850 Testato presso IBS (Austria) IBS secondo Ö B 3800/3850		Steunhoeken verstelbaar Cales de feuillure réglables Rebate supports adjustable Verstellbare Eckwinkel Glasanschlag	Escuadra de alineamiento regulable Katowy naroznik nastawny Squadrette di allineamento regolabile
	Brandwerend Anti-feu Fire-proof Feuerhemmend	Resistente al fuego Ognioodporne Anti fuoco		Hoekverbinding met nagel Equerre avec cheville Corner cleat with drive pin Eckverbinder mit Stift	Escuadra con clavia Lacznik narozny sworzniowy Squadretta a spinare
 EN EI 60	Testen uitgevoerd volgens norm EN 1634-1(deuren) en EN 1364-1 (beglaasde wanden) Essais effectués par conformément la norme EN 1634-1(portes) et EN 1364-1(parois vitrés) Tests carried out according to standard EN 1634-1(deurs) EN 1364-1(glazed partitioning) Prüfungen gemäß Norm EN 1634-1(Türen) und EN 1364-1(verglaste Wände)	Ensayos realizados según norma 1634-1/ EN 1364-1 - Badania wykonane według normy 1634-1 / EN 1364-1 - Antifuoco secondo EN 1634-1 / EN 1364-1 -		T-verbinding met nagel Jonction-T avec cheville T-bracket with drive pin T-Verbinder mit Stift	Topo de union con clavia Lacznik teowy sworzniowy Cavallotto a spinare
 EN EI 30	Testen uitgevoerd volgens norm EN 1634-1(deuren) en EN 1364-1 (beglaasde wanden) Essais effectués par conformément la norme EN 1634-1(portes) et EN 1364-1(parois vitrés) Tests carried out according to standard EN 1634-1(deurs) EN 1364-1(glazed partitioning) Prüfungen gemäß Norm EN 1634-1(Türen) und EN 1364-1(verglaste Wände)	Ensayos realizados según norma 1634-1/ EN 1364-1 - Badania wykonane według normy 1634-1 / EN 1364-1 - Antifuoco secondo EN 1634-1 / EN 1364-1 -		T-verbinding met nagel voor buitendraaiend raam Jonction-T avec cheville pour fenêtre ouvrant vers l'ext. T-bracket with drive pin outward opening window T-Verbinder mit Stift nach ausßen öffnendes Fenster	Topo unión con clavia apertura exterior Lacznik teowy sworzniowy do okien otwieranych na zewnatrz Cavallotto a spinare ap. est.
	Toebehoren brandwerend Accessoires anti-feu Fire-proof accessories Feuerhemmender Zubehör	Accesorios resistente al fuego Aksesoria ognioodporne Accessori Anti fuoco		Verstelbare T-verbinding Jonction-T réglable Adjustable T-bracket Verstellbarer T-Verbinder	Union T regulable Lacznik teowy nastawny Giunti a T regolabili
	Gelaagd glas Verre feuilleté Laminated glass Verbundglas	Vidrio Laminado Szyba laminowana Vetro laminato		Kruisverbindingen Jonctions transversales Cross connections Kreuzverbindungen	Uniones transversales Polaczenie krzyzowe Collegamento a croce
	Glas Verre Glass Glas	Vidrio Szyba Vetro		Kruisverbinding met schroef Jonction transversale avec vis Cross connection with screw Kreuzverbinding mit Schraube	Union transversal con tornillo Polaczenie krzyzowe skrecane Collegamento a croce con viti
	Handleiding Manuel Manual Gebrauchsanweisung	Manual Instrukcja Manuale		Bevestiging drager Fixation chevon Fixation rafter Befestigung Dachsparren	Fijacion mainel Mocowanie krokwi Fissaggio montante
	Alleen voor CS 59 Seulement pour CS 59 Only for CS 59 Nur für CS 59	Solo para CS 59 Tylko do CS 59 Solo per CS 59			
	Alleen voor CS 68 Seulement pour CS 68 Only for CS 68 Nur für CS 68	Solo para CS 68 Tylko do CS 68 Solo per CS 8			
	Alleen voor CS 77 Seulement pour CS 77 Only for CS 77 Nur für CS 77	Solo para CS 77 Tylko do CS 77 Solo per CS 77			

	Eénpuntsluiting Fermeture à 1 point 1-Point lock Einfachverriegelung	Cerradura de 1 punto Zamek 1-punktowy Serratura a 1 punto di chiusura		Elektrische deurpener Gâche pour serrure électrique Electric door opener Elektrischer Türöffner	Portero automatico Elektrorygiel Apertura porta elettrica
	Eénpuntsluiting met dagschieter Fermeture à 1 point à pêne 1-Point lock with latch Einfachverriegelung mit Falle	Cerradura 1 punto golpe Zamek 1-punktowy Serratura a 1 punto di chiusura con scrocco		Deurgrendels en kantschuiven Verrous de condamnation portes Flush and door bolts Kantriegel und Türriegel	Pasadores puerta Rygle biemych skrzydel drzwiowych Catenacciolo chiusura centrale
	Eénpuntsluiting met rol Fermeture à 1 points à rouleau 1-Point lock with roller Einfachverriegelung mit Rolle	Cerradura de 1 punto con rodillo Zamek 1-punktowy z barylka Serratura a 1 punto di chiusura con rullino		Geen elektrische spanning bij gesloten deur En cas de porte fermé pas des tension électrique No electric tension in case of closed door Keine elektrische Spannung bei geschlossen Tür	Sin tensión eléctrica en caso de que la puerta esté cerrada Brak elektrycznego napiecia w przypadku zamkniętych drzwi Stacco tensione a porta chiusa
	Haakslot Serrure à crochet Hook lock Hakenschluss	Cerradura gancho Zamek hakowy Serratura a gancio		Raampompen Crémones Window handles Handhebel	Cremona Klamka okienna Cremonese
	Tweepuntsluiting Fermeture à 2 points 2-Point lock Zweifachverriegelung	Cerradura de 2 puntos Zamek 2-punktowy Serratura a 2 punti di chiusura		Deurkrukken Béquilles Door handles Türdrücker	Manubrios Klamka drzwiowa Maniglie
	Driepuntsluiting Fermeture à 3 points 3-Point lock Dreifachverriegelung	Cerradura de 3 puntos Zamek 3-punktowy Serratura a 3 punti di chiusura		Sluitingen dubbele deur Serrures pour porte double Locks for double door Türtreibriegel	Cerradura puerta doble Blokada drzwi dwuskrzydlowych Serratura porta a 2 ante
	Driepuntsluiting met rol Fermeture à 3 points à rouleau 3-Point lock with roller Dreifachverriegelung mit Rolle	Cerradura de 3 puntos con rodillo Zamek 3-punktowy z barylka Serratura a 3 punti di chiusura con rullino		Raampomp naar buiten draaiend raam Crémone fenêtre ouvrant vers l'extérieur Handle outward opening window Handhebel nach aussen öffnendes Fenster	Cremona ventana apertura exterior Klamka okna otwieranego na zewnątrz Cremonese apertura est.
	Vierpuntsluiting Fermeture à 4 points 4-Point lock Vierfachverriegelung	Cerradura de 4 puntos Zamek 4-punktowy Serratura a 4 punti di chiusura		Raamscharnieren Paumelles pour fenêtres Window hinges Fensterbänder	Bisagras ventana Zawias okienny Cerniere
	Vijfpuntsluiting Fermeture à 5 points 5-Point lock Fünffachverriegelung	Cerradura de 5 puntos Zamek 5-punktowy Serratura a 5 punti di chiusura		Deurscharnieren 2-delig Paumelles porte 2-partite Door hinges 2-part Türbänder 2-teilig	Pernio puerta 2 palas Zawias drzwiowy 2-czesciowy Cerniera 2 ali
	Vijfpuntsluiting met rol Fermeture à 5 points à rouleau 5-Point lock with roller Fünffachverriegelung mit Rolle	Cerradura de 5 puntos con rodillo Zamek 5-punktowy z barylka Serratura a 5 punti di chiusura con rullino		Deurscharnieren 3-delig Paumelles porte 3-partite Door hinges 3-part Türbänder 3-teilig	Pernio puerta 3 palas Zawias drzwiowy 3-czesciowy Cerniera 3 ali
	Zespuntsluiting Fermeture à 6 points 6-Point lock Sechsfachverriegelung	Cerradura de 6 puntos Zamek 6-punktowy Serratura a 6 punti di chiusura		Afstandsbusen Pièces de distance Set of distance bushes Distanzbuchsen	Piezas distanciadoras Tuleje dystansowe Set distanziali
	Zevenpuntsluiting Fermeture à 7 points 7-Point lock Siebenfachverriegelung	Cerradura de 7 puntos Zamek 7-punktowy Serratura a 7 punti di chiusura		Geen afstandsbusen nodig Pas de pièces de distance No distance bushes needed Keine Distanzbuchse	No necesario piezas distanciadoras Brak koniecznosci stosowania tuleji dystansowych Senza distanziali
	Espagnoletslot Fermeture espagnolette Espagnolette Lock Treibriegelverschluss	Cierre ventana Zamek drzwiowy do blokady pionowej Serratura a spagnoletta		Inbraakwerende kogel Bille anti-vol Anti-burglar ball Einbruchhemmende Kugel	Bola proteccion antirobbo Kulka antywłamaniowa Anticasso
	Cilinders Cylindres Cylinders Zylinder	Bombines Cylindry Cilindri		Dieveklauw Pene anti-degondage Anti-lift pin Sicherheitsbolzen	Perno antielevador Bolec antywyważeniowy Antisolleveranto
	Cylinderplaten Ecussons Cylinder covers PZ-Rosette	Escudos bombin Oslona wkładki bebenkowej Copertura cilindri		Kozjindorpelveer Pivot de frein aerien Overhead closer Obentürschliesser	Muelle aereo Samozamykacz gorny Chiudi porta sup.
	Slotpads Gâches Receivers Schliessbleche	Gancho Gniazdo rygla zamka Riscontri		Vloerveer Pivot de frein au sol Floor closer Bodentürschliesser	Muelle pavimento puerta Samozamykacz podlogowy Chiudi porta inf.
	Deursluiters Ferme-porte Door closer Türschliesser	Cierrapuertas Samozamykacz drzwiowy Chijdiporta			















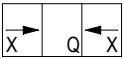

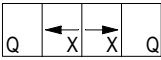

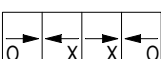

	Eindstuk deurvleugel Pièce finale ouvr. porte End piece door vent Endkappe Türflügel	Tapeta hoja puerta Koncowka do skrzydła drzwiowego Terminale anta		Binnenbeglazingsdichting Joint à bourrer Inner glazing gasket Innenverglasungsdichtung	Junta de acristalado interior Uszczelka przyszybowa wewnętrzna Guarnizione del vetro interna
	Eindstukken bodemprofiel Pièces finales profilé de seuil End pieces floor profile Endkappe Schwelle	Piezas terminales perfil suelo Koncowki profilu podlogowego Terminale soglia		Buitenbeglazingsdichting Joint de vitrage extérieur Outer glazing gasket Aussenverglasungsdichtung	Junta de acristalado exterior Uszczelka przyszybowa zewnętrzna Guarnizione del vetro esterna
	Eindstukken Z-T deur Bouchon profilé porte Z-T End pieces Z-T door Endkappe Z-T Tür	Tapetas puerta Z-T Element koncowy Z-T drzwi Terminale profili porte Z e T		Buitenbeglazingsdichting Joint de vitrage extérieur Outer glazing gasket Aussenverglasungsdichtung	Junta de acristalado exterior Uszczelka przyszybowa zewnętrzna Guarnizione del vetro esterna
	Afdichtingen dorpels Profils latéral pour bavettes Sill end pieces Endstück für Wetterschenkel	Tapetas condensacion Koncowki do profili podokiennych Tappi soglia		Akoestische dichting Joint acoustique Acoustical seal gasket Flügelauflagsdichtung	Junta acustica Uszczelka akustyczna Guarnizione di isolamento acustico
	Glassteunen Supports cale de vitrage Glazing supports Klotzbrücken	Soportes vidrio Podporka pod przeszklenie Supporti per vetro		Middendichtingen Joints centraux Central gaskets Mitteldichtungen	Junta central Uszczelka centralna Guarnizione centrale
	Afdekkap voor waterafvoersleuven Capuchon écoulement d'eau Weep hole cover Abdeckkappe Entwässerung	Deflector aire Maskownica otworu drenazowego Paratempesta		Aanslagdichting Joint de butée Butt strip Anschlagdichtung	Junta tope Uszczelka Guarnizione di battuta
	Eindstukken stolprofielen Bouchons double ouvrant End parts double casement profile Endkappe Stulpprofil	Tapetas perfil doble hoja Koncowka profilu ruchomego slupka Tappo inversione		Dilatatie dichting Joints de dilatation Expansion gaskets Dehnungsdichtungen	Junta de dilatacion Uszczelka dylatacyjna Guarnizione di espansione
	Koppelstuk Piec de raccordement Connection piece Kopplungsstueck	Pieza de union Element laczacy Accessori collegamento		Dichting Joint Gasket Dichtung	Junta Uszczelka Guarnizione
	Eindstukken voor stolprofielen Bouchons pièce finale pour profilé double ouvrant End parts for double casement profiles Endkappen für Stulpprofile	Tapeta perfil doble hoja Koncowka profilu ruchomego slupka Tappi 2 ante		Dichting Joint Gasket Dichtung	Junta Uszczelka Guarnizione
	Afdichting goot Fermeture gouttière End piece gutter Endkappe Rinne	Tapetas canal Koncowka rynny Terminale gronda		Afdichtingsstuk Pièce d'étanchéité Sealing piece Dichtstück	Pieza de sellado Element uszczelniający Accessorio per sigillatura
	Afdichting goot Fermeture gouttière End piece gutter Endkappe Rinne	Tapetas canal Koncowka rynny Terminale gronda		Opzwellende Dichting Joint Gonflant Swelling Gasket Schwellende Dichtung	Junta veranda Uszczelka do werandy Guarnizione espansione
	Eindstuk Piec finale End piece Endkappe	Terminal Koncowka Terminale		Dichting veranda Joint véranda Gasket veranda Dichtung Wintergarten	Junta veranda Uszczelka do werandy Guarnizione veranda
	Stootplaat Arrêt vitrage toiture Glass panel stop Endstück Verglasung	Tope del panel de vidrio Ogranicznik wypełnienia Ferro x vetro		Borsteldichtingen Joints brosse Brushes Bürstendichtungen	Cepillos Szczotki Spazzole
	Veranda type 1 Veranda type 1 Veranda type 1 Veranda Typ 1	Veranda tipo 1 Weranda typu 1 Veranda tipo 1		Isolerend vulstuk Pièce de remplissage isolante Insulating filling piece Isolierendes Füllstück	Pieza de relleno aislante Wkładka izolacyjna Riempimento isolanta
	Paniekdeur Porte de panique Panic door Paniktür	Puerta antipánico Drzwi antypaniczne Porta antipanico		Einddichting Joint d'assemblage End gasket Enddichtung	Junta Uszczelka koncowka Angolo prestampato
	Diversen Divers Miscellaneous Diverse	Diversos Elementy uzupełniające Varie		Isolatie Isolant Insulation Isolation	Aislamiento Izolacja Isolante
	Klemstuk Clip Clip Federklemme	Clip Uchwyt Clip		Brievenklemmen Entrées de courrier Letter boxes Briefeinwurf	Buzones Skrzynka na listy Cassetta posta
	Nokbevestiging Fixation de la faîtière Fixation of the ridge Firstanschluss	Fijacion del resalte Element mocujący kalenicowy Fissaggio colmo		Automatische deur dichtingen Fermetures automatiques Automatic door latches Automatische Türdichtungen	Cierrapuertas automaticos Drzwiowa automat. opadająca listwa Dispositivo di chiusura soglia
				Variant Variante Variant Variante	Variante Variant Variante

	Stolp-kipraam Fenêtre double ouvr.-batt. Double casem.-tilt window Stulpfenster D/DK	Ventana abatible doble hoja Okno rozwierano-uchylne dwuskrzydlowe Finestra a 2 ante ribalta		DRAAISCHUIFFRAAM OUVRANT PROJETANT SIDE-HUNG SLIDING WINDOW DREHSCHIEBEFENSTER
	Draaikip Oscillo-battant Turn and tilt Drehkip	Oscilobatiante Okno rozwierno-uchylne Anta ribalta		
	Kipdraai Battantes-ouvrantes Tilt and turn Kippdreh	Batiante oscilante Okno uchylno-rozwierane Anta ribalta inversa		
	Draairaam Fenêtre ouvrante Side-hung window Drehfenster	Ventana practicable Okno rozwierane Battente		
	Stolpraam Fenêtre double ouvrant Double casement window Stulp-Flügel Fenster	Ventana doble hoja Okno rozwierane wuskrzydlowe Finestra a 2 ante		
	Valraam Fenêtre à soufflet Bottom hung window Kipp-Fenster	Ventana abatible Okno uchylne Wasistas		
	Afstandbedieningen valraam Commandes à distance pour fenêtre à soufflet Remote control for fanlight window Oberlichtbeschlag für Kipp-Flügel	Funcionamiento a distancia para ventana de techo Mechanizm do dystansowego uchylania okien Vasistas con telecomando		
	Buitendraaiend raam Fenêtre ouvrant vers l'extérieur Outside opening window Nach aussen öffnendes Fenster	Ventana apertura exterior Okno otwierane na zewnątrz Finestra ad apertura esterna		Verankeringen Ancrages Fixing lugs Verankerungen
	Uitzetakraam Châssis à l'italienne Top-hung window Senk-Klappfenster	Ventana proyectante con compas Okno wychylne na zewnątrz Sporgere con frizioni		Sluitpennen en sluitstukken Rouleaux et gâches Lock pins and lock plates Schliessrollen und Schliessstücke
	Tuimel- en taatsraam Châssis pivotant Pivot window Schwingflügel	Ventana pivotante Okno obrotowe Bilico		Goot Gouttière Gutter Rinne
	Vouwdeur Porte pliante Folding door Falttür	Puerta plegable Drzwi harmonijkowe Veranda libro		Dakvenster Tabatière Attic window Dachfenster
	Schuifkip (TF) Couissant-tombant (TF) Slide and tilt (TF) Schiebekipptür (TF)	Paralela Uchylno-przesuwny Scorrevole parallelo		Kunststof dakbedekking Toiture synthétique Synthetic roofing Kunststoff Dachdeckung
	Schuifraam Fenêtre coulissante Sliding window Schiebefenster	Ventana corredera Okno przesuwne Scorrevole		Zelfklevende dubbelzijdige tape Bande autocollante 2 faces Self-adhesive double sided tape Selbstklebendes beidseitiges Band
	Parallel opengaand raam Fenêtre ouvrant parallèle Parallel opening window Parallelausstellfenster	Ventana proyectante paralela Okno rownolegle wysuwane na zewnątrz Sporgere parallelo		Domotica Domotique Domotics Domotik
	Kipraam Fenêtre battante Tilt window Kippfenster	Oscilo Okno uchylne Vasidas		Profielen met hoge isolatiewaarde Profils avec valeur d'isolation élevée Profiles with high insulation value Profile mit hohen Isolationswert
	Dubbele deur buitendraaiend Porte double ouvrant vers l'ext. Double door outward opening Zweiflügelige Tür aussen öffnend	Puerta doble apertura exterior Drzwi dwuskrzydlowe otw. nazew. Porta due ante apertura esterna		Wielen Galets Rollers Laufwagen
	Deur binnendraaiend Porte ouvrant vers l'int. Door inward opening Tür nach innen öffnend	Puerta apertura interior Drzwi otw. do wewnątrz Porta apertura interna		Regeltringels Triangles de réglage Adjustment rods Regulierstange
	Deur buitendraaiend Porte ouvrant vers l'ext. Door outward opening Tür aussen öffnend	Puerta apertura exterior Drzwi otw. na zewnątrz Porta apertura esterna		Geleidingsplaat Guide Guide plate Führung
				Anclajes Kotwy Ancoraggio
				Bulones y cerraderos Płytki i kolek ryglujacy -
				Canal Rynna Gronda
				Ventana de techo Okno dachowe Lucernario
				Cubierta en material sintético Wypelnienie poliweglanem na dachy Pannelo
				Cinta autoadhesiva de dos caras Biadesivo
				Domótica Domótica Domótica
				Perfiles alto aislamiento térmico Profile o wysokiej izolacyjności termicznej Alto isolarento
				Ruletas Wozki Carrelli
				Varilla de ajuste Listwy regulacyjne Astina
				Placa guia Element naprowadzajacy Guida

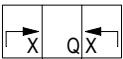
	Gereedschap Outillage Tool Werkzeug	Util Narzędzie Utensile		Hydropneumatische pers Presse hydropneumatique Hydropneumatic press Hydropneumatische Presse	Prensa neumática Prasa hydropneumatyczna Pressa idropneumatica
	Gereedschappen en machines voor ontwatering van kader Outillage et machinerie pour drainage dormant Tools and machinery for draining outer frame Werkzeuge und Maschinen für Entwässerung Blendrahmen	Utiles y maquinaria para el drenaje del marco Narzędzia i maszyny do drenazy oscieźnic Utensili e macchinari per il drenaggio del telaio		Zaagmachine Tronçonneuse Sawing machine Kreissäge	Maquina de corte Pila do cieć przestrzennych Macchina per taglio
	Gereedschappen en machines voor ontwatering van vleugel Outillage et machinerie pour drainage ouvrant Tools and machinery for draining vent Werkzeuge und Maschinen für Entwässerung Flügel	Utiles y maquinaria para el drenaje de la hoja Narzędzia i maszyny do drenazy skrzydeł Utensili e macchinari per il drenaggio dell'anta		Hoekenpers Sertisseuse Crimper Eckverbindungsmaschine	Ensambladora Zaciskarka narozy Cianfrinatrice
	Gereedschappen en machines voor T-verbinding Outillage et machinerie pour jonction-T Tools and machinery for T-brackets Werkzeuge und Maschinen für T-Verbinder	Utiles y maquinaria para topes de unión Narzędzia i maszyny do polaczen teowych Utensili e macchinari per i giunti		Handmatrijs Matrice manuelle Manual punch tool Handstanzwerkzeug	Prensa manual Wykrojnik ręczny Punzonatrice manuale
	Gereedschappen en machines voor kruikuitsparing Outillage et machinerie pour fermeture Tools and machinery for closure Werkzeuge und Maschinen für Beschläge	Utiles y maquinaria para el cierre Narzędzia i maszyny do zamknięć Utensili e macchinari per le chiusure		Gereedschap voor lijminjectie Outillage pour encollage Tool for injection Werkzeug fuer Klebeinjektion	Util para inyeccion Narzędzie do wtrysku kleju Utensile colla
	Multifunctionele matrijs Matrice multifonctionnelle Multifunctional punch tool Mehrzweckstanzwerkzeug	Matriz multifuncional Wykrojnik wielofunkcyjny Punzonatrice multifunzionale		Gereedschap voor krukken Outillage pour cremones Tool for handles Werkzeug fuer Handhebel	Util para manetas Narzędzie do klamek Utensile per maniglie
	Geleide matrijs Matrice guidée Punch tool Stanzwerkzeug	Matriz Wykrojnik Punzonatrice		Gereedschap voor sluitlatten Outillage pour tringles Tool for linkbars Werkzeug fuer Schubstange	Util para barras union Narzędzie do listew sterujacych okuciami Utensile per barre di collegamento
	Handmatig gereedschap Outillage manuel Manual tools Handwerkzeuge	Util manual Narzędzie ręczne Dime		Gereedschap voor T-verbindingen Outillage pour connections-T Tool for T-connections Werkzeug fuer T-Verbindungen	Util para topes de union Narzędzie do polaczen Teowych Utensile per travesi
	Freessjabloon Calibre de fraisage Stencil plate for milling head Fräseschablone	Plantilla para copiadora Szablon do frezarki Maschera per pantografo		Klemblokken Blocs de serrage Clamping blocks Spannbacken	Bloques de presión Blokli zaciskowe Blocchetti di supporto
	Enkelkopse freesmachine Frais, à copier à une broche Copy router 1 spindle Einspindel-Kopierfräse	Copiadora de un cabezal Frezarka z jedna głowica Pantografo di copia a 1 mandrino 1 mandrino		Gereedschap voor ontwatering buitenkaders Outillage pour drainage dormants Tool for drainage outer frames Werkzeug fuer Entwaesserung Blendrahmen	Util drenaje marco Narzędzie do drenazy oscieźnic Utensile per drenaggio telaio
	Frees- en boormachine Fraiseuse et foreuse Router and drilling machine Fräse- und Bohrerät	Copiadora taladradora Frezarka z wiertarka Centro dilavoro		Gereedschap voor hoekverbinding Outillage pour connection d'equerre Tool for corner connection Werkzeug fuer Eckverbindung	Util union esquina Narzędzie do polaczen narozynych Utensile per connessioni d'angolo
	Handmatig gereedschap Outillage manuel Manual tools Handwerkzeuge	Util manual Narzędzie ręczne Dime		Gereedschap voor montage Outillage pour montage Tool for assembly Werkzeug fuer Montage	Util para colocacion Narzędzie do montazu Utensile assemblaggio
	Freessjabloon Calibre de fraisage Stencil plate for milling head Fräseschablone	Plantilla para copiadora Szablon do frezarki Maschera per pantografo		Gereedschap voor deursluite Outillage pour fermeture porte Tool for door closer Werkzeug fuer Türschliesser	Util para cierrapuertas Narzędzie do samozamykacza drzwiowego Utensile chiu di porta
	Enkelkopse freesmachine Frais, à copier à une broche Copy router 1 spindle Einspindel-Kopierfräse	Copiadora de un cabezal Frezarka z jedna głowica Pantografo di copia a 1 mandrino 1 mandrino		Gereedschap voor scharnieren Outillage pour charnieres Tool for hinges Werkzeug fuer Bänder	Util para bisagras Narzędzie do zawiasy Utensile cerniere
	Frees- en boormachine Fraiseuse et foreuse Router and drilling machine Fräse- und Bohrerät	Copiadora taladradora Frezarka z wiertarka Centro dilavoro		Gereedschap voor sloten Outillage pour fermetures Tool for locks Werkzeug fuer Schlösser	Util para cerraduras Narzędzie do zamka Utensile serrature
	Handmatig gereedschap Outillage manuel Manual tools Handwerkzeuge	Util manual Narzędzie ręczne Dime		Gereedschap voor wisselprofielen Outillage pour chicanes Tool for sections Werkzeug fuer Wechselprofile	Util para encuentros centrales Narzędzie do przekrojow Utensile chicanes
	Handmatig gereedschap Outillage manuel Manual tools Handwerkzeuge	Util manual Narzędzie ręczne Dime		Gereedschap voor beglazing Outillage pour vitrage Tool for glazing Werkzeug fuer Verglasung	Util para acristalamiento Narzędzie do przeszklen Utensile vetro
	Handmatig gereedschap Outillage manuel Manual tools Handwerkzeuge	Util manual Narzędzie ręczne Dime		Gereedschap voor diverse toepassingen Outillage pour applications divers Tool for miscellaneous applications Werkzeug fuer diverse Anwendungen	Utiles para varias aplicaciones Narzędzie do montazu elementow uzupełniajacych Utensile vari

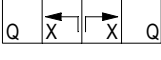
	Gereedschap voor dichtingen Outillage pour joints Tool for gaskets Werkzeug für Dichtungen	Util para juntas Narzędzie do uszczelki Utensile guarnizioni		Pneumatische aandrijving Propulsion pneumatic Pneumatic drive Pneumatische Antrieb	Destornillador neumático Pneumatyczny naped Cilindro pneumatica
	Gereedschap voor bevestiging wielen Outillage pour fixation des roulettes Tool for fixation rollers Werkzeug für Befestigung Laufräder	Util para fijación de ruletas Narzędzie do montażu wozków Utensile carrelli		Ponsunit Unité d'étampér Punch unit Stanzeinheit	Punzon Wykrojník Unita punzonatrice
	Gereedschap voor ontwatering vleugels Outillage pour drainage ouvrants Tool for drainage vents Werkzeug für Entwässerung Flügel	Util para drenaje hoja Narzędzie do drenażu skrzydła Utensile drenaggio anta		Min. profiellengte Longueur min. de profilé Min. length of profile Min. Profillänge	Longitud mínima del perfil Minimalna długość profilu Lunghezza minima profilo
	Uitfrezing voor inbouw bovenspeun in kozijn Fraisage pour encastrement gond supérieur dans la fenêtre Milling for building in upper pivot in window Ausfräsung für Einbau eines oberen Lagers im Rahmen	Fresado para pivotante en marco superior Frez do montażu gornego sworznia w oknie Lavorazioni super. finestra pivotante		Max. profiellengte Longueur max. de profilé Max. length of profile Max. Profillänge	Longitud máxima del perfil Maksymalna długość profilu Lunghezza max profilo
	Uitfrezing voor inbouw vloerspeun in vleugel Fraisage pour encastrement gond inférieur dans l'ouvrant Milling for building in floor pivot in vent Ausfräsung für Einbau eines Bodenlagers im Flügel	Fresado para pivotante en hoja inferior Frez do montażu dolnego sworznia w skrzydle Lavorazioni infer. finestra pivotante		Max. profielhoogte Hauteur max. de profilé Max. height of profiles Max. Profilhöhe	Altura máxima del perfil Maksymalna wysokość profilu Max altezza
	Uitfrezing voor inbouw bovenspeun in vleugel Fraisage pour encastrement gond supérieur dans l'ouvrant Milling for building in upper pivot in vent Ausfräsung für Einbau eines oberen Lagers im Flügel	Fresado para pivotante en hoja superior Frez do montażu gornego sworznia w skrzydle Lavorazione super. finestra pivotante		Max. horizontale beweging Movement max. horizontale Max. horizontal movement Max. horizontale Versetzung	Movimiento horizontal máximo Maksymalny ruch poziomy Spostamento orizz. max
	Monteertafel Table de montage Assembly bench Montagetisch	Banco de montaje Stół montażowy Banco montaggio		Horizontaal hoekbereik Intervalle d'équerre horizontale Horizontal corner range Eckbereich Horizontal	Rango de corte a inglete horizontal Zakres katów poziomych Dimensione taglio orizz.
	Elektrische aansluiting Fixation électrique Electric connection Elektrisches Anschluss	Conexión eléctrica Polaczenie elektryczne Connessione elettrica		Verticaal hoekbereik Intervalle d'équerre verticale Vertical corner range Eckbereich Vertikal	Rango de corte a inglete vertical Zakres katów pionowych Dimensione taglio vert.
	Compressor Compresseur Compressor Kompressor	Compresor Kompresor Compressore		Motor Moteur Motor Antrieb	Motor Silownik napędowy Motore
	Kogel Dr. Hahn Bille Dr. Hahn Ball Dr. Hahn Kugel Dr. Hahn	Bola Dr. Hahn Kulka Dr. Hahn -		Gewicht Poids Weight Gewicht	Pesos Ciężar Peso
	Elektrische aansluiting Fixation mécanique Mechanical connection Mechanischer Anschluss	Conexión mecánica Polaczenie mechaniczne Fissaggio meccanico		Max. toerental Vitesse d'axe max. Max. spindle speed Max. Drehzahl	Velocidad de sierra Maksymalna predkość obrotowa Velocità max lama

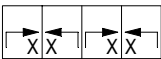
WK II

TYPE OF ELEMENT	SYSTEM	STANDARD	REPORT NUMBER	EXPIRY DATE
	CP 155	DIN V ENV 1627	PIV NR. 23-8/09 	---
	CP 155	DIN V ENV 1627	PIV NR. 23-8/09 	---
	CP 155	DIN V ENV 1627	PIV NR. 23-8/09 	---
	CP 155	DIN V ENV 1627	PIV NR. 23-8/09 	---
	CP 155	DIN V ENV 1627	PIV NR. 23-8/09 	---
	CP 155-LS	DIN V ENV 1627	PIV NR. 23-9/08 	---
	CP 155-LS	DIN V ENV 1627	PIV NR. 23-9/08 	---
	CP 155-LS	DIN V ENV 1627	PIV NR. 23-9/09 	---
	CP 155-LS	DIN V ENV 1627	PIV NR. 23-9/09 	---
	CP 155-LS	DIN V ENV 1627	PIV NR. 23-9/09 	---

(*) Min/max afmetingen geldig voor beslag inbouw,
Min/max afmetingen in functie van het systeem

(*) Dimensions min./max. valables pour l'encastrement d'accessoires,
Dimensions min./max. en fonction du système



stelsel catalogoog



catalogue système

ANTI-BURGLAR PROF.	ANTI-BURGLAR ACC.	SUPPLIER	MIN/MAX CERT. DIMENSION (*)	
		Sobinco	Fbmin: 888 mm Fhmin: 1560 mm	Fbmax: 1221 mm Fhmax: 2145 mm
		Sobinco	Fbmin: 888 mm Fhmin: 1560 mm	Fbmax: 1221 mm Fhmax: 2145 mm
		Sobinco	Fbmin: 888 mm Fhmin: 1560 mm	Fbmax: 1221 mm Fhmax: 2145 mm
		Sobinco	Fbmin: 888 mm Fhmin: 1560 mm	Fbmax: 1221 mm Fhmax: 2145 mm
		Sobinco	Fbmin: 888 mm Fhmin: 1560 mm	Fbmax: 1221 mm Fhmax: 2145 mm
		Siegenia	Fbmin: 880 mm Fhmin: 1504 mm	Fbmax: 1210 mm Fhmax: 2068 mm
		Siegenia	Fbmin: 880 mm Fhmin: 1504 mm	Fbmax: 1210 mm Fhmax: 2068 mm
		Siegenia	Fbmin: 880 mm Fhmin: 1504 mm	Fbmax: 1210 mm Fhmax: 2068 mm
		Siegenia	Fbmin: 880 mm Fhmin: 1504 mm	Fbmax: 1210 mm Fhmax: 2068 mm
		Siegenia	Fbmin: 880 mm Fhmin: 1504 mm	Fbmax: 1210 mm Fhmax: 2068 mm

(*) Minimal- und maximalabmessungen für Einbau von Zubehör,
Minimal- und Maximalabmessungen in funktion von System



system katalog

(*) Min- and max. sizes valid for building in of accessories,
Min- and max. sizes in function of the system



system catalogue

CP 155-AP CP 155-LS/AP

OVERZICHT TESTRAPPORTEN
APERÇU RAPPORTS D'ESSAI
OVERVIEW TEST REPORTS
UEBERSICHT PRUEFBERICHTE



B



Algemene informatie systemen

Généralités séries

General Information System

Allgemeine Information System

VERWERKINGSVOORSCHRIFTEN

I ALGEMEEN

Zie catalogus "1.Algemene informatie" (099.C01E.00 editie 11/2004)

II VERWERKINGSVOORSCHRIFTEN CONCEPT PATIO CP 155 / CP 155-LS

II.1 CONSTRUCTIEVOORSCHRIFTEN

Om blijvend een perfect eindproduct te garanderen, dienen tijdens de verwerking bepaalde regels in acht genomen te worden.

II.1.1 Verspanende bewerkingen

Onder verspanende bewerkingen wordt verstaan: alle mechanische bewerkingen zoals zagen, frezen, boren, ponsen en knippen. Voor gelakte profielen is het essentieel dat de laklagen aan de randen niet loskomen tijdens deze bewerkingen.

Het is daarom van groot belang voor de kwaliteit van de verbindingen dat:

- het verspanende gereedschap geschikt en voldoende scherp is;
- de machines goed afgeregeld zijn (bv. Toerental);
- een regelmatige controle van het gereedschap gebeurt;
- het verspanende gereedschap correct en voldoende gesmeerd wordt: smeerstick Reynalube (art. nr. 086.9191.UN) voor zaagbladen, snijmiddel (art. nr. 086.9175.UN) voor ponsgereedschap of de door de machineleveranciers voorgeschreven koel- en smeermiddelen;
- de gepaste klemblokken worden gebruikt;
- de aan- en afvoertafel vrij zijn van spanen en verontreinigingen; (zie montagetekening klemblokken)
- eventuele koeling gebeurt met chemische neutrale producten die de oppervlaktebehandeling niet aantasten.

Positie / klemming van de profielen tijdens het zagen:

De positie van de profielen op de zaagtafel tijdens het verzagen is zeer belangrijk en is de basis om perfecte verstekken te bekomen na montage van schuifelementen.

De grootste druk moet steeds op de "referentiezijde" van de profielen uitgeoefend worden.

De "referentiezijde" moet perfect horizontaal of verticaal op de zaagtafel geplaatst worden.

Klemblokken moeten gebruikt worden:

- a. om te vermijden dat speling op de profielen de kwaliteit van het verstek zou beïnvloeden;
- b. om te vermijden dat de profielen zouden kantelen op de tafel.

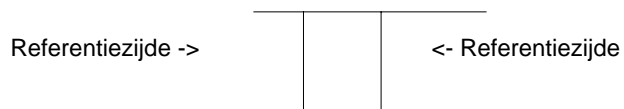

FOUTIEVE KLEMMING

FOUT: De hoofdklemming drukt op de zichtkant van het te verzagen profiel en het profiel kantelt.

GEVOLG: Scheve zaagsnede – de buitenzijde is korter dan de binnenzijde.

RESULTAAT: Bij het persen van de hoeken is het verstek aan de binnenzijde keurig dicht en gaapt aan de buitenzijde.

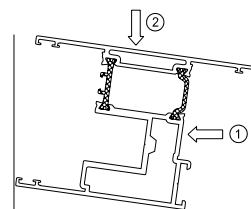

JUISTE KLEMMING

De hoofdklemming drukt op de sponningzijde. De zichtkant ondergaat een kleinere, secundaire druk.

Het profiel heeft niet de neiging te kantelen of te vervormen tijdens het zagen, en het persen van de in verstek gezaagde profielen kan probleemloos verlopen.

Opmerking:

Het verdient aanbeveling om spanen die ontstaan tijdens het zagen af te zuigen.

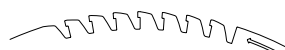
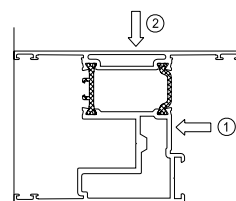
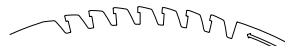

II.1.2

Assemblage

Wij maken de volgende onderverdeling:

1. Hoekverbindingen;
2. T-verbindingen en kruisverbinding;
3. Ontwatering en uitsparingen voor het beslag;
4. Dichtingen.

II.1.2.1 Hoekverbindingen

II.1.2.1.1 Persen

Stappen: * optie A: lijminjectie na persen

** optie B: lijminjectie voor persen

- a. Correct zagen.
- b. * Aanbrengen van lijminjectiegaten (\varnothing 3.5/4mm)
- c. Beschermen van de zaagsneden en bewerkte vlakken door:
 - ontbramen (indien noodzakelijk).
 - verwijderen van stof en zaagresten op de zaagsnede en in de profielkamer.
- d. ontvetten (Reynafinish 60 art. nr. 086.9210.--);
- e. aanbrengen van Reynaprotector (art. nr. 086.9209.--) op zaag/freessnedes.
- f. ** Verlijmen in profielkamer: aanbrengen van een goedgekeurd dichtingslijm (Reynaseal duo art. nr. 084.9080.--):
- g. Aanbrengen pershoeken en vulhoeken.
- h. Verbinding tot stand brengen en persen
- i. * Lijminjectie ter hoogte van voorziene injectiegaten door middel van een goedgekeurd dichtingsmiddel (Reynaseal duo art. nr. 084.9080.--)
- j. De samengevoegde elementen dienen enkel aan de zichtvlakken gereinigd te worden van lijmresten en dit uitsluitend met een niet-agressief middel (Reynafinish 60 art. nr. 086.9210.--).

Opmerkingen:

- Om een goede afdichting te voorzien van de buitenkader dient men een extra afdichtingsstuk te voorzien tussen de rechte hoekverbinding.
 - a. 2-rail hefschuifdeur (CP 155-LS)
 - Onder-en bovenaan art. nr. 062.9396.--
 - b. 3-rail hefschuifdeur (CP 155-LS)
 - onder- en bovenaan art. nr. 062.9399.04
 - c. monorail
 - onderaan art. nr. 062.9396.—
 - bovenaan art. Nr. 062.9392.—
 - d. 2-rail flat bottom
 - onder- en bovenaan art. nr. 062.9397.--

II.1.2.1.2 Schroeven

Stappen:

- a. Correct zagen.
- b. Aanbrengen van schroefgaten
- c. Beschermen van de zaagsneden en bewerkte vlakken door:
 - ontbramen (indien noodzakelijk).
 - verwijderen van stof en zaagresten op de zaagsnede en in de profielkamer.
- d. ontvetten (Reynafinish 60 art. nr. 086.9210.--);
- e. aanbrengen van Reynaprotector (art. nr. 086.9209.--) op zaag/freessnedes.
- f. Aanbrengen schroefhoeken en vulhoeken.
- g. Verbinding tot stand brengen en schroeven en vernagelen.
- h. De samengevoegde elementen dienen enkel aan de zichtvlakken gereinigd te worden van lijmresten en dit uitsluitend met een niet-agressief middel (Reynafinish 60 art. nr. 086.9210.--).

Opmerkingen:

- Om een goede afdichting te voorzien van de buitenkader dient men een extra afdichtingsstuk te voorzien tussen de rechte hoekverbinding.
 - e. 2-rail hefschuifdeur (CP 155-LS)
 - Onder-en bovenaan art. nr. 062.9396.--
 - f. 3-rail hefschuifdeur (CP 155-LS)
 - onder- en bovenaan art. nr. 062.9399.04
 - g. monorail
 - onderaan art. nr. 062.9396.—
 - bovenaan art. Nr. 062.9392.—
 - h. 2-rail flat bottom
 - onder- en bovenaan art. nr. 062.9397.--

II.1.2.1.3 Vernagelen

Stappen:

- a. Correct zagen.
- b. Aanbrengen van pengaten.
- c. Beschermen van de zaagsneden en bewerkte vlakken door:
 - ontbramen (indien noodzakelijk).
 - verwijderen van stof en zaagresten op de zaagsnede en in de profielkamer.
- d. ontvetten (Reynafinish 60 art. nr. 086.9210.--);
- e. aanbrengen van Reynaprotector (art. nr. 086.9209.--) op zaag/freessnedes.
- f. Aanbrengen schroefhoeken en vulhoeken.
- g. Verbinding tot stand brengen en vernagelen of pennen.
- h. De samengevoegde elementen dienen enkel aan de zichtvlakken gereinigd te worden van lijmresten en dit uitsluitend met een niet-agressief middel (Reynafinish 60 art. nr. 086.9210.--).

Opmerkingen:

- Om een goede afdichting te voorzien van de buitenkader dient men een extra afdichtingsstuk te voorzien tussen de rechte hoekverbinding.
 - i. 2-rail hefschuifdeur (CP 155-LS)
 - Onder-en bovenaan art. nr. 062.9396.--
 - j. 3-rail hefschuifdeur (CP 155-LS)
 - onder- en bovenaan art. nr. 062.9399.04
 - k. monorail
 - onderaan art. nr. 062.9396.—
 - bovenaan art. Nr. 062.9392.—
 - l. 2-rail flat bottom
 - onder- en bovenaan art. nr. 062.9397.--

II.1.2.2 T-Verbindingen

Stappen:

- a. Correct zagen T-profiel.
- b. Aanbrengen gaten T-verbinder (Ø 7mm: binnenschaal; Ø 3.5mm: buitenschaal).
- c. Uitravelen T-profiel (hoogte **25** mm)
- d. Bescherming van de zaagsneden en bewerkte vlakken door:
 - Ontbramen (indien noodzakelijk);
 - Verwijderen van stof en zaagresten op de zaagsnede en in de profielkamer;
- e. Ontvetten (Reynafinish 60 art. nr. 086.9210.--);
- f. Aanbrengen van Reynaprotector (art. nr. 086.9209.--) op zaag/freesneden.
- g. Afdichten van T-profiel door aanbrengen van een neutraal, elastisch dichtingmiddel:
 - Op de zaagsneden;
 - Op de bevestigingsgaten;
- h. Afdichting van zone onder T-profiel op het kaderprofiel, door plaatsen van afdichtingselementen of aanbrengen van een neutraal elastisch dichtingsmiddel. Deze dienen volledig waterdicht uitgevoerd te worden. (monorail)

Opmerking: De zone onder de T-profielen mag niet volledig waterdicht uitgevoerd worden om een gecontroleerde ontwatering van de vleugel te bekomen (Zie bladzijde 34.F. ...).

- i. Verbinding tot stand brengen: De T-verbinder wordt gepositioneerd op centerlijn, T-profiel wordt hierover aangebracht, T-verbinder wordt vastgeschroefd en vernageld (of 2x vernageld).
- j. De samengevoegde elementen dienen enkel aan de zichtvlakken gereinigd te worden van dichtingresten en dit uitsluitend met een niet-agressief middel (Reynafinish 60 art. nr. 086.9210.--).

II.1.2.3 Ontwatering, ontluchting en uitsparingen voor het beslag

Stappen:

- a. Aftekenen uitsparingen.
- b. Correct ponsen, boren of frezen.
- c. Beschermen van de bewerkte vlakken door:
 - Ontbramen (indien noodzakelijk).
 - Verwijderen van stof en zaagresten op de zaagsnede en in de profielkamer.
- d. Ontvetten (Reynafinish 60 art. nr. 086.9210.--).
- e. Aanbrengen van Reynaprotector (art. nr. 086.9209.--).

Aandachtspunten bij de ontwatering / ontluchting:

Eventueel binnendringend water moet vlot en gecontroleerd kunnen afgevoerd worden en de druk in de binnenkamers moet gelijk blijven aan die van de buitenlucht.

- Bij elk schuifelement worden er ontwateringopeningen voorzien met een maximale afstand tot de hoek van 250 mm voor de vleugel en 150 mm voor het vast kader. De afstand tussen 2 ontwateringopeningen bedraagt max. 800 mm. Per raamvak dienen min. 2 ontwateringsopening voorzien te worden!
- Steeds op het laagste punt van de glassponning afwateren
- Alle types schuifelementen moeten voorzien zijn van een ontwateringsysteem in de onderregels en / of de horizontale T-profielen.

- De minimale oppervlakte van deze ontwateringsopeningen bedraagt 50 mm² per opening in de vleugel, hetzij een ronde opening van minimum 8 mm diameter, hetzij langwerpige openingen van minimaal 5 mm bij 15 mm. Voor het vast kader bedraagt de minimale oppervlakte 150 mm² per opening hetzij 3 ronde openingen van min. 8 mm diameter, hetzij een langwerpige opening van minimaal 8 mm bij 34 mm.
- Ontwateringgaten die aan de buitenzijde van het schuifelement zichtbaar zijn, worden afgedekt met kunststofkapjes.
- Bij elk schuifelement worden er ontluchtingsgaten voorzien. De functie hiervan is de drukegalisatie rond de beglazing te waarborgen.
 - o Aan de zijkant bovenaan van de vleugel wordt steeds minimum 1 opening van minimum 5 mm geboord.
 - o Bij een vast licht wordt de buitenbeglazingsdichting (080.9114.SY) onderbroken over een afstand van 50 mm.

Opmerking: Voor specifieke ontwateringen verwijzen wij naar bladzijde 34.F. ...

II.1.2.4 Dichtingen

Alle dichtingrubbers zijn van weer- en verouderingsbestendig EPDM. De verwerking ervan dient zorgvuldig te gebeuren, aangezien hiervan de dichtheid van het schuifelement afhangt.

a. Het aanbrengen van de beglazingsdichtingen/dichtingen.

Stappen:

1. Correct versnijden: Het versnijden van de beglazingsdichting dient met een speciale schaar (art. nr. 090.0121.UN) te gebeuren en de dichting kan naargelang de soort profielverbinding in verstek of recht versneden worden. Benodigde overlengte (ca 10 mm per meter) dient voorzien te worden.
2. Aanbrengen dichting: de dichtingen worden aangebracht in de daarvoor voorziene groeven van de profielen; de overlengte wordt lichtjes opgestuikt om uitzetten of krimpen op te vangen. Moeilijkheden bij het inbrengen kunnen opgevangen worden met siliconenspray (art. nr. 086.9551.--).
3. Verlijmen (afdichten): in de hoeken dient de beglazingsdichting verlijmd te worden met vulkaniseerlijm (Unzionement art. nr. 084.9103.--). Doordat de verbinding elastisch blijft, sluit de dichting ook in de hoeken perfect aan.

b. Het aanbrengen van de borsteldichtingen.

Stappen:

1. Correct versnijden: het versnijden van de borsteldichting dient met een speciale schaar (art. nr. 090.0121.00) te gebeuren en de dichting kan naargelang van de soort profielverbinding in verstek of recht versneden worden.
2. Aanbrengen borsteldichting: de borsteldichtingen worden geschoven in de daarvoor voorziene groeven van de profielen.
3. Verlijmen: Naargelang de soort profielverbinding (recht) dient de borsteldichting aan de uiteinden verlijmd te worden met secondenlijm (Reynaglue art. nr. 084.9105.--). Deze verlijming is noodzakelijk om het uitglijden van de borsteldichting te vermijden.

c. Het aanbrengen van een afdichting onder- en bovenaan het wisselprofiel.

Om een goede water- en winddichtheid te bekomen dient onder- en bovenaan het wisselprofiel een extra afdichting geplaatst te worden:

- 2-rail schuifdeur (CP 155)
 - onder- en bovenaan art. nr. 062.8025.04
- 3-rail schuifdeur (CP 155)
 - onder- en bovenaan 2x art. nr. 062.8025.04
- Monorail schuifdeur (CP 155)
 - onder- en bovenaan art. nr. 062.8027.04
- 2-rail hefschuifdeur (CP 155-LS)
 - onderaan art. nr. 062.8011.04
 - bovenaan art. nr. 062.8036.04
- 3-rail hefschuifdeur (CP 155-LS)
 - onderaan 2x art. nr. 062.8011.04
 - bovenaan 2x art. nr. 062.8036.04
- Monorail hefschuifdeur (CP 155-LS)
 - onderaan art. nr. 062.8012.04

- bovenaan art. nr. 062.8037.04

De afdichting bovenaan moet gemonteerd worden na het inheffen van de vleugels.

II.2 MONTAGEVOORSCHRIFTEN

II.2.1 Inbouw in de ruwbouw

De bevestiging aan de ruwbouw gebeurt ofwel rechtstreeks doorheen de profielen met bijvoorbeeld schroeven en pluggen, ofwel met behulp van bevestigingsankers.

- De bevestigingen mogen niet minder dan 40 mm van de wand van de ruwbouw worden aangebracht.
- De verankering mag geenszins het draagvermogen van de aangrenzende bouwonderdelen beïnvloeden.
- Alle verankeringen, voor zover niet uit aluminium of roestvrij staal, dienen afdoende tegen corrosie te zijn beschermd en mogen zelf ook geen aantasting van het aluminium veroorzaken.
- Bij de plaatsing van de schuifelementen worden er voldoende bevestigingen voorzien:

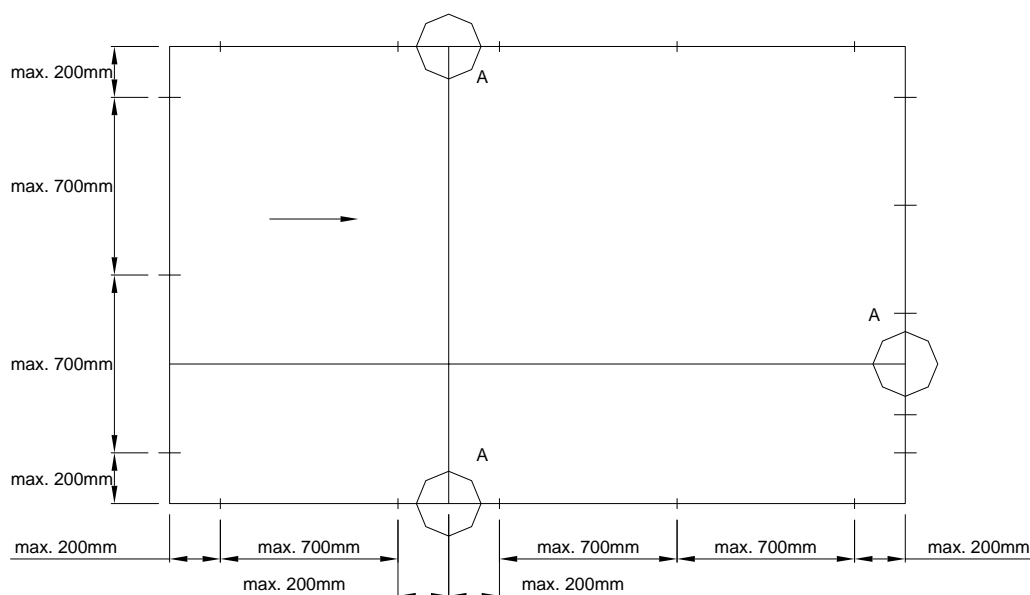

Er dienen aan alle zijden minstens 2 bevestigingen aangebracht te worden met een maximale afstand tot de hoek van 200 mm.

- De afstand van de bevestigingen onderling bedraagt maximum 700 mm.
- Op de plaatsen waar een tussenregel of tussenstijl op de zijstijl, boven- of onderregel aansluit, moet de verankering op maximum 200 mm naast de stijl- of regelaansluiting worden aangebracht. (A).
Hierdoor wordt bereikt dat de tussenregel en de tussenstijl een lengteverandering (ten gevolge van temperatuurverandering) zonder schade kunnen ondergaan.
- Aan te raden is de bevestigingen te positioneren ter hoogte van ieder sluitpunt.

Opmerking: De verankeringen dienen dusdanig aangebracht te worden dat ze eventuele zettingen van het schuifelement kunnen opvangen.

Bij gebruik van schroeven en pluggen doorheen de profielen mogen de kamers in het onderste vast kader niet doorboord worden om geen waterinfiltratie te bekomen ter hoogte van deze bevestiging.

II.2.2 Inbouw van het beslag

Keuze van bevestigingspunten, aantal sluitpunten, max. Vleugelgewicht, max. Vleugelafmetingen, toegepast vleugelprofiel e.a. dient te gebeuren volgens de richtlijnen van de systeemleverancier en de

beslagfabrikant.

Glijdende en bewegende delen zijn van neutraal vet te voorzien.

Bij montage controleren of het beslag soepel en zonder hapering te bedienen is.

II.3 BEGLAZING

Al onze systemen zijn ontworpen voor beglazing met EPDM-rubbers of neutrale siliconenkit. Bij siliconenbeglazing dient een rugvulling aangebracht te worden om een correcte opening tussen het glaspaneel en het aluminiumkader te creëren. Wij raden u aan onze speciaal ontwikkelde beglazingsrubbers te gebruiken. De beglazing hiermee zal vlotter en betrouwbaar verlopen, duurzamer zijn in tijd, en beschadigde glaspanelen zullen gemakkelijker vervangen kunnen worden.

Bij de beglazing dient rekening te worden gehouden met volgende punten:

- Door opstuiken van de rubber wordt vermeden dat er daarna openingen ontstaan in de hoeken.
- Drainagegaten dienen geboord te worden om waterophoping te vermijden. Dit is ook noodzakelijk bij siliconenbeglazing (zie drainagetekeningen).
- Voor het plaatsen van het glas dient rekening gehouden te worden met een speling van minimum 12 mm op het aluminiumraam (6 mm per zijde).
- De glassteunen die zich aan de onderzijde van het glaspaneel bevinden, dienen afgedicht te worden (zie tekening hieronder).

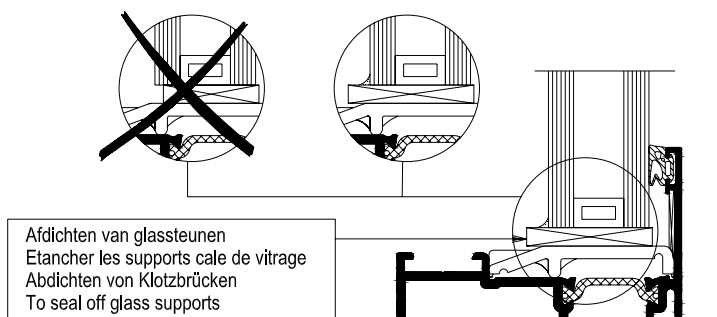

Bevestiging van de beglazing.

Geen enkel glaspaneel mag rechtstreeks in contact komen met aluminium zonder tussenplaatsing van beglazingsblokjes en een rubberdichting.

Door het opspieën van het glas vermijdt men niet enkel dit contact, maar wordt eveneens een juiste plaatsing in het schuifelement bekomen en het eigen gewicht van het glas wordt op de juiste wijze overgebracht naar de wielen teneinde een eventuele vervorming van de vleugel te voorkomen.

Om het vastzetten te vereenvoudigen, beschikken wij over glassteunen die gebruikt worden om de bodem van te effenen. Hierop kan men dan rechthoekige beglazingsblokjes plaatsen.

Bij dubbele en driedubbele beglazing moet extra aandacht besteed worden dat het glas steeds over de volledige glasdikte ondersteund wordt en dat de steunblokjes (C1) voldoende sterk zijn om het volledige glasgewicht te kunnen dragen.

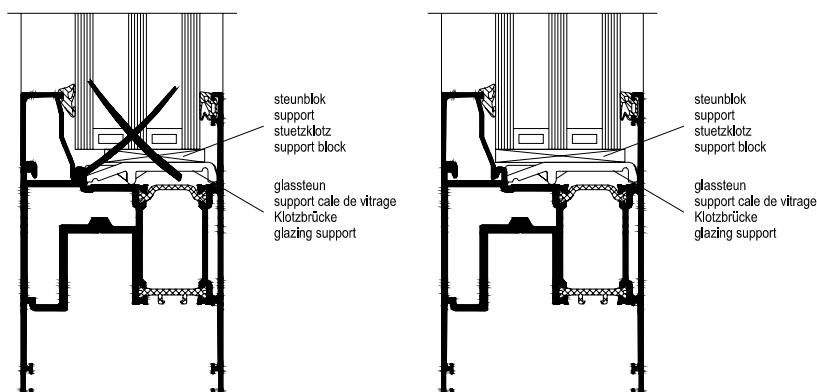

Het aantal en de plaats van de beglazingsblokjes wordt bepaald door norm STS38.

Een overzicht: In de beglazingsblokjes onderscheiden wij 2 types:

steunblokjes



stelblokjes

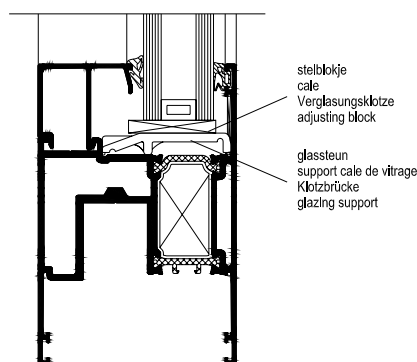
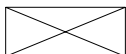

C1: Steunblokjes

Deze blokjes brengen het gewicht van het glas over op de vleugel of het raamkozijn. Hun goede plaatsing is van groot belang voor de werking van de schuifelementen.

C2: Stelblokjes

Deze blokjes verzekeren de positionering van het glas tussen de sponning. Ze worden aangebracht zonder forceren. Hun doel is elke beweging van het glas in zijn vlak uit te schakelen.

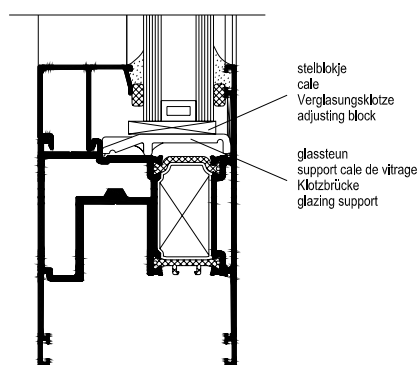

De volgende schetsen geven de plaatsing van de beglazingsblokjes in de verschillende types schuifelementen aan.

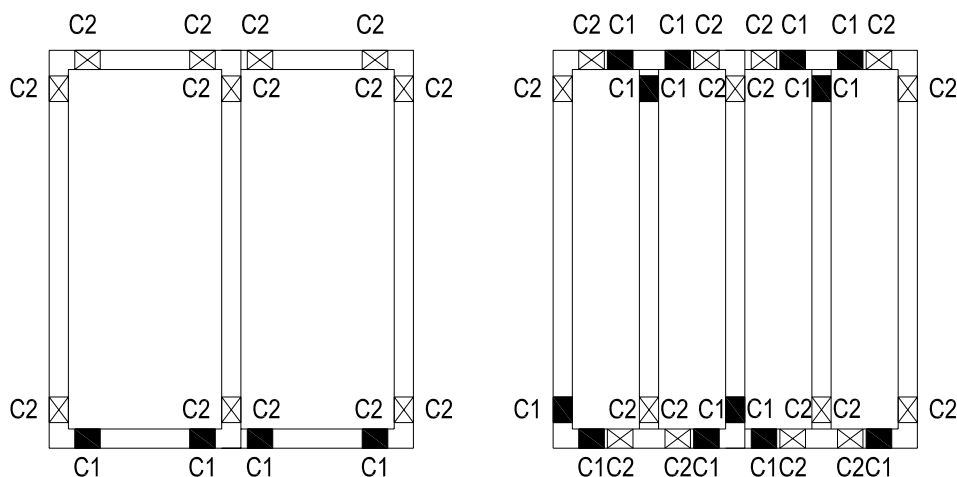

Bij schuivende vleugels dient het glasgewicht overgebracht te worden naar de wielen. De steunblokjes (C1) moeten dus geplaatst worden ter hoogte van de wielen.

Bij vaste vleugels dient het glasgewicht overgebracht te worden naar het steunstuk van de vaste vleugel. De steunblokjes moeten dus geplaatst worden ter hoogte van het steunstuk.

Bij vaste beglazing monorail brengt men de ondersteuning aan in de hoeken van de onderregel om te beletten dat deze gaat doorbuigen onder het gewicht van het glas (zie schets monorail).

Om het vastzetten te vereenvoudigen, beschikken wij over glassteunen die gebruikt worden om de bodem van de sponning te effenen. Hierop kan men dan rechthoekige beglazingsblokjes plaatsen.

RECOMMANDATIONS DE MISE EN OEUVRE

I GENERAL

Voir catalogue "1. Informations générales" (099.C01E.00 édition 11/2004)

II RECOMMANDATIONS DE MISE EN OEUVRE CONCEPT PATIO CP 155 / CP 155-LS

II.1 RECOMMANDATIONS DE FABRICATION

Afin de garantir un produit final parfait, certaines règles doivent être suivies pendant la fabrication.

II.1.1 Opérations d'usinage

Par opérations d'usinage on entend: toutes les opérations mécaniques comme le tronçonnage, le fraisage, le forage, le poinçonnage et la découpe. Il est essentiel que la couche de laque des profils laqués ne se détache pas sur les bords pendant ces opérations.

Il est donc très important pour la qualité des assemblages que:

- Les outils d'usinage soient adaptés et suffisamment aiguisés;
- Les machines soient bien réglées (p.ex. régime);
- Un contrôle régulier des outils ait lieu;
- Les outils d'usinage soient correctement et suffisamment graissés:
bâton lubrifiant Reynalube (art. n°. 086.9191.UN) pour lames de scie, huile de coupe (art. n°. 086.9175.UN) pour outils de poinçonnage ou les réfrigérants et lubrifiants prescrits par les fournisseurs des machines;
- Les mors de serrage adaptés soient utilisés;
- La table d'amenée ou d'évacuation soit exempte de copeaux et de souillures;
- Le refroidissement éventuel se fasse à l'aide de produits chimiquement neutres qui ne corrodent pas le traitement de surface.

Position / serrage des profils pendant le tronçonnage:

La position des profils sur la table de sciage pendant le tronçonnage est très importante et est la base pour obtenir des onglets parfaits après montage des éléments coulissants.

La pression principale doit toujours être exercée sur la "face de référence" des profils..

La "face de référence" doit être positionnée parfaitement horizontalement ou verticalement sur la table de sciage.

Les mors de serrage doivent éventuellement être utilisés:

- a. Pour éviter que les tolérances sur les profils influencent la qualité de l'onglet;
- b. Pour éviter que les profils ne basculent sur la table.

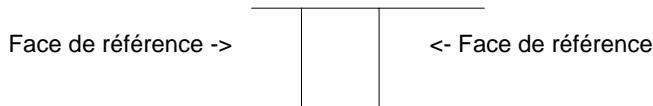

MAUVAIS TRONCONNAGE

DEFAUT: Le vérin principal presse sur la surface visible du profile à tronçonner entraînant son décalage.

CONSEQUENCES: Coupe d'onglet en biais, côtés extérieurs raccourcis par rapport aux côtés intérieurs.

RESULTAT: Après sertissage, l'assemblage sur la face intérieure est correct, tandis qu'à l'extérieur l'onglet s'est ouvert.

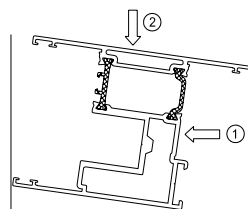

TRONCONNAGE CORRECT

Le vérin principal exerce sa pression sur la face de la feuillure. La surface visible ne subit que la pression réduite du vérin secondaire. Le profilé n'a pas tendance à se décaler ou à se déformer pendant la coupe et le sertissage des profilés sciés à onglet peut s'effectuer sans problèmes.

Remarque:

Il est recommandé d'aspirer les copeaux pendant le tronçonnage.

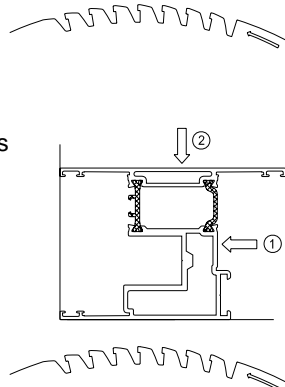

II.1.2

Assemblage

Nous faisons la subdivision suivante:

1. raccords d'angle;
2. assemblages T;
3. drainage, aération et découpes pour les accessoires;
4. joints.

II.1.2.1 Raccords d'angle

II.1.2.1.1 A sertir

Etapes: * option A : injection de colle après le sertissage

** option B : injection de colle avant le sertissage

- a. Tronçonnage parfait.
- b. * Application des trous pour l'injection de colle ($\varnothing 3.5/4\text{mm}$)
- c. Protection des coupes et des surfaces traitées par:
 - ébavurage (si nécessaire);
 - enlèvement des poussières et des copeaux de sciage sur la coupe et dans la chambre du profilé.
- d. dégraissage (Reynafinish 60 art. n°. 086.9210.--);
- e. application de Reynaprotector (art. n°. 086.9209.--)
- f. ** Encollage dans la chambre du profilé: appliquer une colle d'étanchéité approuvée (Reynaseal duo art. n°. 084.9080.--).
- g. Application des équerres à sertir et des équerres de remplissage.
- h. Raccorder et sertir.
- i. * Injection de colla à la hauteur des trous pour l'injection de colle à l'aide d'une colle à deux composants (Reynaseal duo art. n° 084.9080.--).
- j. Sur les éléments composes, les résidus de colle ne doivent être enlevés que des surfaces visibles, et ceci uniquement à l'aide d'un produit non-agressif (Reynafinish 60 art. n°. 086.9203.--).

Remarques:

- Afin d'obtenir une bonne étanchéité du dormant, une fermeture doit être montée entre le raccord d'angle droit.
 - a. 2-rail hefschuifdeur (CP 155-LS)
 - en bas et en haut art. n°. 062.9396.--
 - b. 3-rail hefschuifdeur (CP 155-LS)
 - en bas et en haut art. n°. 062.9399.04
 - c. monorail
 - en bas art. n°. 062.9396.—
 - en haut art. n°. 062.9392.—
 - d. 2-rail flat bottom
 - en bas et en haut art. n°. 062.9397.--

II.1.2.1.2 A visser

Etapas:

- a. Tronçonnage parfait.
- b. Application des trous à visser.
- c. Protection des coupes et des surfaces traitées par:
 - ébavurage (si nécessaire);
 - enlèvement des poussières et des copeaux de sciage sur la coupe et dans la chambre du profilé.
- d. dégraissage (Reynafinish 60 art. n°. 086.9210.--);
- e. application de Reynaprotector (art. n°. 086.9209.--)
- f. Application des équerres à visser et des équerres de remplissage.
- g. Raccorder et visser et goupiller.
- h. Sur les éléments composites, les résidus de colle ne doivent être enlevés que des surfaces visibles, et ceci uniquement à l'aide d'un produit non-agressif (Reynafinish 60 art. n°. 086.9203.--).

Remarques:

- Afin d'obtenir une bonne étanchéité du dormant, une fermeture doit être montée entre le raccord d'angle droit.
 - e. 2-rail hefschuifdeur (CP 155-LS)
 - en bas et en haut art. n°. 062.9396.--
 - f. 3-rail hefschuifdeur (CP 155-LS)
 - en bas et en haut art. n°. 062.9399.04
 - g. monorail
 - en bas art. n°. 062.9396.—
 - en haut art. n°. 062.9392.—
 - h. 2-rail flat bottom
 - en bas et en haut art. n°. 062.9397.--

II.1.2.1.3 A goupiller

Etapas:

- a. Tronçonnage parfait.
- b. Application des trous à goupiller.
- c. Protection des coupes et des surfaces traitées par:
 - ébavurage (si nécessaire);
 - enlèvement des poussières et des copeaux de sciage sur la coupe et dans la chambre du profilé.
- d. dégraissage (Reynafinish 60 art. n°. 086.9210.--);
- e. application de Reynaprotector (art. n°. 086.9209.--)
- f. Application des équerres à visser et des équerres de remplissage.
- g. Raccorder et goupiller.
- h. Sur les éléments composites, les résidus de colle ne doivent être enlevés que des surfaces visibles, et ceci uniquement à l'aide d'un produit non-agressif (Reynafinish 60 art. n°. 086.9203.--).

Remarques:

- Afin d'obtenir une bonne étanchéité du dormant, une fermeture doit être montée entre le raccord d'angle droit.
 - i. 2-rail hefschuifdeur (CP 155-LS)
 - en bas et en haut art. nr. 062.9396.--
 - j. 3-rail hefschuifdeur (CP 155-LS)
 - en bas et en haut art. nr. 062.9399.04
 - k. monorail
 - en bas art. nr. 062.9396.—
 - en haut art. Nr. 062.9392.—
 - l. 2-rail flat bottom
 - en bas et en haut art. nr. 062.9397.--

II.1.2.2 Assemblage T

Etapas:

- a. Tronçonnage parfait de la traverse.
- b. Application des trous des raccordement-T (Ø7mm: demi-profile intérieur; Ø3.5mm: demi-profile extérieur).
- c. Fraiser la hauteur de la rainure de la traverse (hauteur **25** mm)
- d. Protection des coupes et des surfaces traitées par:
 - ébavurage (si nécessaire);
 - enlèvement des poussières et des copeaux de sciage sur la coupe et dans la chambre du profilé;
- e. dégraissage (Reynafinish 60 art. n°. 086.9210.--);
- f. application de Reynaprotector (art. n°. 086.9209.--);
- g. Etanchement de la traverse : appliquer de la matière d'étanchéité neutre :
 - sur les coupes;
 - sur les trous de fixation;
- h. Etanchement de la zone au dessous des traverses sur le profilé dormant en appliquant des éléments d'étanchéité ou d'une matière neutre.
Ceux-ci doivent être complètement étanches à l'eau. (monorail)

Remarque: La zone sous les profils T ne peut pas être rendue complètement étanche afin d'obtenir un drainage contrôlé de l'ouvrant (voir pages 34.f. ...).

- i. Assemblage: la jonction T est positionnée sur la ligne de centrage, la traverse est introduit, vissée et chevillée (ou 2x chevillée).
- j. Sur les éléments composes, les résidus de matière d'étanchéité ne doivent être enlevés que des surfaces visibles, et ceci uniquement à l'aide d'un produit non-agressif (Reynafinish 60 art.n°. 086.9210.--).

II.1.2.3 Drainage, aération et découpes pour les accessoires

Etapas:

- a. Marquer les découpes.
- b. Poinçonnage, forage ou fraisage correct.
- c. Protection des surfaces traitées par:
 - ébavurage (si nécessaire);
 - enlèvement des poussières et des copeaux sur les scies et dans la chambre du profilé
- d. dégraisse (Reynafinish art. n°. 086.9210.--);
- e. application de Reynaprotector (art. n°. 086.9209.--) ;

Lors du drainage / aération, il faut prêter attention aux points suivants:

Les eaux d'infiltration éventuelles doivent être évacuées de façon rapide et contrôlée vers l'extérieur et il faut maintenir la chambre de décompression à la pression atmosphérique.

- Pour chaque élément coulissant, des ouvertures de drainage sont prévues à une distance maximale de l'angle de 250 mm pour l'ouvrant et de 150 mm pour le dormant. La distance maximale entre 2 ouvertures de drainage est de 800 mm.
Pour chaque surface vitrée il faut prévoir 2 trous de drainage !
- Il faut toujours drainer au niveau de point le plus bas de la feuillure de vitrage.
- Les éléments coulissants, quel que soit leur type, doivent obligatoirement être drainées au niveau des traverses basses et intermédiaires.
- Les ouverture Pour l'ouvrant, la surface minimale de ces ouvertures est de 50 mm² par ouverture, soit sous forme d'une ouverture ronde avec un diamètre minimal de 8 mm, doit

sous forme d'une ouverture ovale de 5 mm X 15 mm au minimum.

Pour le dormant, la surface minimale est de 150 mm² par ouverture, soit sous forme de 3 ouvertures rondes avec un diamètre minimal de 8 mm, soit sous forme d'ouverture ovale de 8 mm X 34 mm au minimum.

- Les ouvertures de drainage qui sont visibles de l'extérieur de l'élément coulissant doivent recevoir des capuchons en matière synthétique.
- Chaque élément coulissant doit être prévue de trous d'aération. Sa fonction est de garantir l'égalisation de la pression autour du vitrage.
 - o Sur le haut du côté de l'ouvrant, on fore toujours au moins 1 ouverture de 5 mm de diamètre au minimum.
 - o Pour les ouvrants fixes, le joint extérieur (080.9114.SY) doit être interrompu sur une distance de 50 mm.

Remarque: Pour des drainages spécifiques, nous nous référons à la page 34.f. ...

II.1.2.4 Joints

Tous les joints sont en EPDM résistant aux intempéries et au vieillissement. Leur montage doit se faire soigneusement, puisque l'étanchéité de l'élément coulissant en dépend.

a. Application des joints de vitrage / joints.

Etapes:

1. Découpe correcte: la découpe du joint de vitrage doit se faire avec des ciseaux spéciaux (art. n°. 090.0121.UN) et le joint peut être coupé à onglet ou droit en fonction du type de jonction entre les profilés. Une longueur supplémentaire (environ 10 mm par mètre) doit être prévue.
2. Application du joint: les joints sont appliqués dans les rainures des profils prévues à cet effet; la longueur supplémentaire est légèrement refoulée pour neutraliser la dilatation ou le rétrécissement. Les difficultés de mise en place peuvent être résolues à l'aide d'un aérosol silicone (art. n°. 086.9551.--).
3. Encollage (étanchement): dans les angles, le joint de vitrage doit être encollé avec de la colle de vulcanisation (Unizionement art. n°. 084.9103.--). Cette colle permet à la jonction de rester élastique et de garantir parfaitement le rôle du joint même dans les angles.

b. Application des brosses.

Etapes:

1. Découpe correcte: la découpe de la brosse doit se faire avec des ciseaux spéciaux (art. n° 090.0121.00) et le joint peut être coupé à onglet ou droit en fonction du type de jonction entre les profilés.
2. Application de la brosse: les brosses sont appliqués dans les rainures des profils prévues à cet effet.
3. Encollage: En fonction du type de jonction entre les profils (droit), la brosse doit être encollée aux extrémités avec de la colle rapide (Reynaglué art. n°. 084.9105.--). Cet encollage est nécessaire pour éviter le glissement de la brosse.

c. Application d'une fermeture en bas et en haut de la chicane.

Afin d'obtenir une bonne étanchéité à l'eau et au vent, une fermeture supplémentaire doit être montée en bas et en haut de la chicane:

- 2-rail porte coulissante (CP 155)
 - en bas et en haut art. n°. 062.8025.04
- 3-rail porte coulissante (CP 155)
 - en bas et en haut 2x art. n°. 062.8025.04
- Monorail porte coulissante (CP 155)
 - en bas et en haut art. n°. 062.8027.04
- 2-rail porte levant-coulissante (CP 155-LS)
 - en bas art. n°. 062.8011.04
 - en haut art. n°. 062.8036.04
- 2-rail porte levant-coulissante (CP 155-LS)
 - en bas 2x art. n°. 062.8011.04
 - en haut 2x art. n°. 062.8036.04
- Monorail porte levante-coulissante (CP 155-LS)
 - en bas art. n°. 062.8012.04
 - en haut art. n°. 062.8037.04

La fermeture en haut doit être appliquée après le montage des ouvrants.

II.2 RECOMMANDATIONS DE MONTAGE

II.2.1 Montage dans le gros œuvre

La fixation au gros oeuvre se fait soit directement à travers les profiles avec par exemple des vis et des chevilles, soit à l'aide d'ancrages de fixation.

- Les fixations ne peuvent pas être appliquées à une distance inférieure à 40 mm du mur du gros oeuvre..
- L'ancrage ne peut surtout pas influencer la force portante des éléments de construction contigus.
- Tous les ancrages, pour autant qu'ils ne soient pas en aluminium ou en acier inoxydable, doivent être efficacement protégés contre la corrosion et ne peuvent pas corroder l'aluminium.
- Lors de la pose des éléments coulissants, on prévoit des fixations en suffisance:

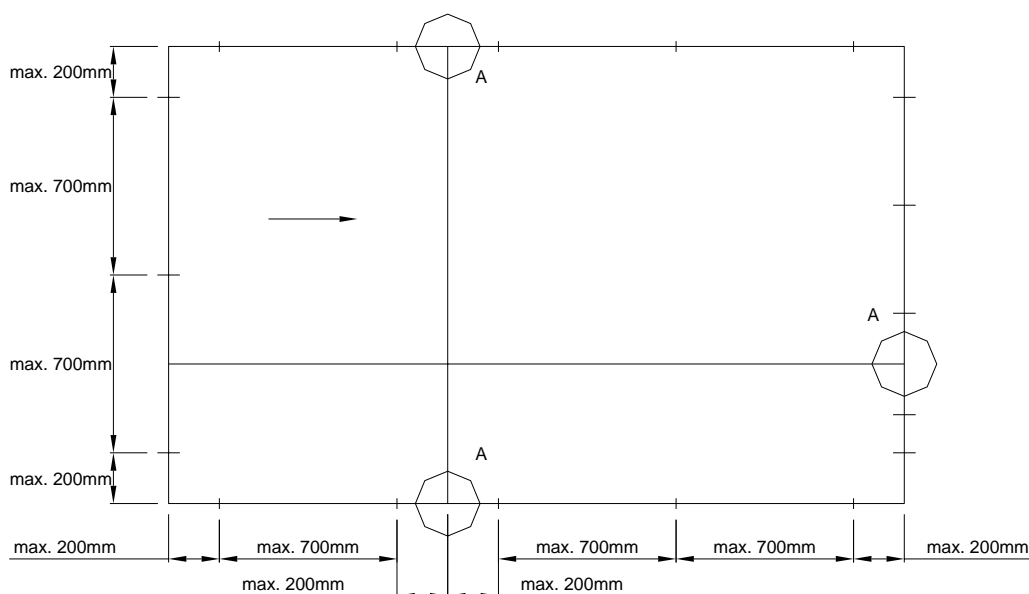

De tous les côtés il doit y avoir au moins 2 fixations avec une distance maximale jusqu'à l'angle de 200 mm.

- La distance entre les fixations est de 700 mm au maximum.
- A l'endroit où des profiles T et des profiles dormants se rencontrent, l'ancrage doit être appliqué à une distance maximale de 200 mm des deux côtés de profile T (A). De cette façon, une dilatation ou un rétrécissement du profile T (dus aux fluctuations de température) sont possibles sans dégâts.
- Il est conseillé de positionner les fixations à la hauteur de chaque point de fermeture.

Remarque: Les ancrages doivent être appliqués d'une telle façon qu'ils peuvent neutraliser des dilatations / rétrécissements éventuels de l'élément coulissant.

Si des vis et des chevilles sont utilisées à travers les profiles, les Chambers dans le dormant inférieur ne peuvent pas être percées afin d'éviter de l'infiltration d'eau à la hauteur de cette fixation.

II.2.2 Montage des accessoires

Le choix des points de fixation, du nombre de points de fermeture, du poids max. D'ouvrant, des dimensions max. d'ouvrant, du profile ouvrant appliqué, etc. doit se faire suivant les introductions du fournisseur des systèmes et du fabricant des accessoires.

Les parties coulissantes et mobiles doivent être pourvues de graisse neutre.

Lors du montage, il faut contrôler si les accessoires peuvent être actionnés de façon souple et sans bloquer.

II.3 VITRAGE

Tous nos systèmes sont conçus pour vitrer à l'aide de joints d'EPDM ou de silicone neutre. En cas d'utilisation d'un joint en silicone, l'usage d'un fond de joint constitué d'un joint-mousse compressible autocollant est recommandé pour maintenir un espace libre suffisant entre le verre et l'aluminium. Nous vous recommandons d'utiliser notre système de joints de vitrage pour des raisons de facilité et fiabilité de mise en œuvre, de bonne tenue dans le temps et de simplicité dans le remplacement de volumes verriers.

Le vitrage devra se faire en respectant les points suivants:

- Le joint doit être refoulé pour éviter qu'apparaissent, dans le temps, des ouvertures dans les angles dues au rétrécissement de ce joint.
- Des ouvertures de drainage doivent être forées afin d'éviter toute stagnation d'eau. Ceci est également nécessaire en cas de vitrage en silicone (voir schémas de drainage).
- Pour la pose des vitrages, le jeu entre vitrage et fond de feuillure doit être de 12 mm (6mm par côté) au minimum.
- Les supports de vitrage qui se trouvent en –dessous du panneau de vitrage doivent être rendus étanches (voir dessin ci-après).

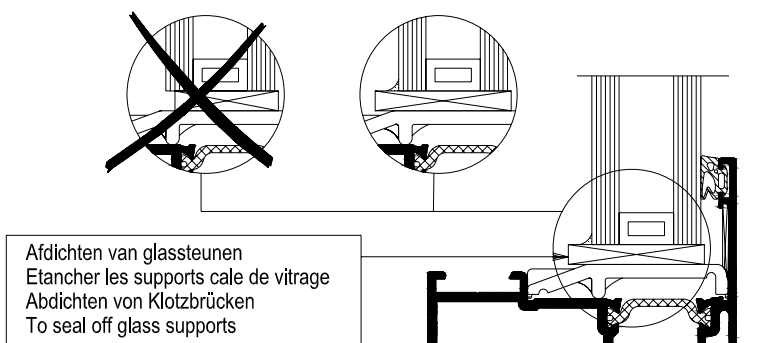

Fixation du vitrage.

Aucun volume verrier ne peut être directement en contact avec l'aluminium. La pose de cales de vitrage et d'un joint est indispensable.

Le but du calage du verre est non seulement d'éviter ce contact, mais également d'obtenir une bonne pose dans l'élément coulissant et de transmettre de façon correcte le poids du verre même sur les galets afin de prévenir une déformation éventuelle de l'ouvrant.

Afin de simplifier le calage du vitrage, nous disposons de supports de vitrage qui sont utilisés pour égaliser le fond de la feuillure. Sur ces supports on peut utiliser des cales de vitrage rectangulaires.

En cas de vitrage double et triple il faut faire attention que le vitrage est complètement supporté sous l'épaisseur totale du vitrage et que les câles de vitrage (C1) sont assez fort pour supporter le poids du vitrage.

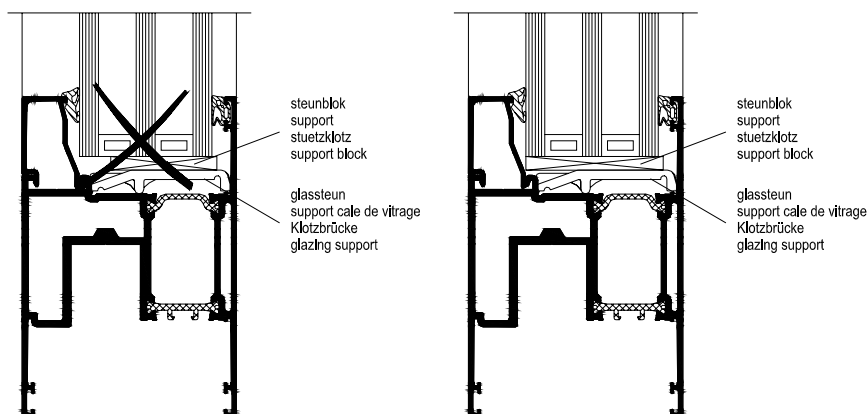

Le nombre et la position des supports de cale de vitrage sont déterminés par le STS 38.

Un aperçu

Nous distinguons 2 types de cales de vitrage:

cale de support



cale d'ajustement



C1: Cales de support

Ces cales transmettent le poids du verre sur l'ouvrant ou sur l'allège, et leur bonne pose est d'une importance capitale pour le fonctionnement des éléments coulissants.

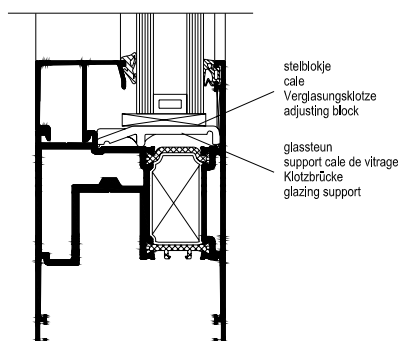

C2: Cales d'ajustement

Ces cales assurent le positionnement du verre par rapport à la feuillure, et sont appliqués sans forcer. Elles empêchent tout mouvement du verre dans son logement.

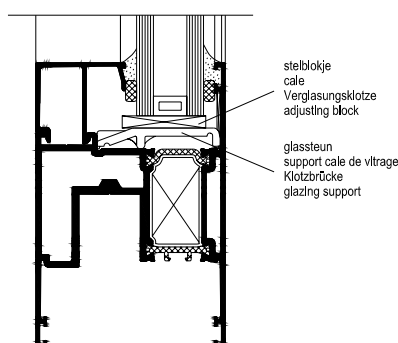

Les schémas suivants indiquent la pose des différentes cales de vitrage dans les différents types d'éléments coulissants.

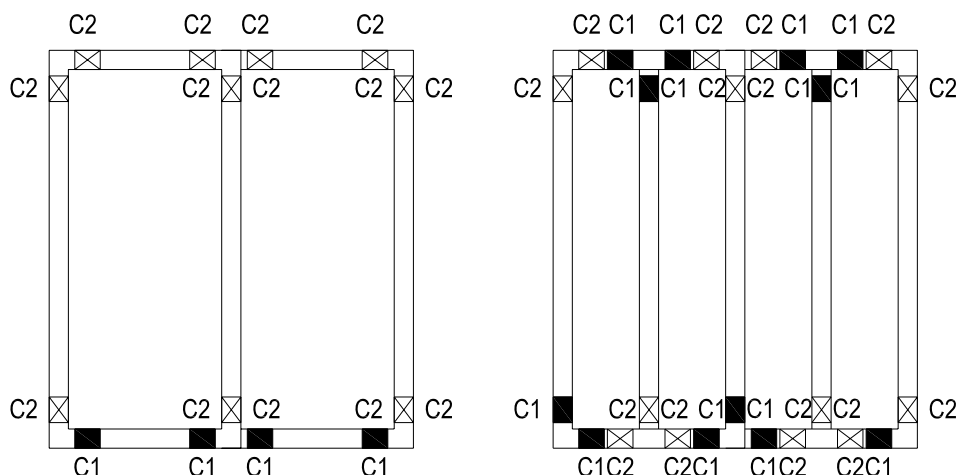

Le poids de vitrage des ouvrants coulissants doit être transmis sur les galets. Les cales de support (C1) doivent donc être montées à la hauteur des galets.

Le poids de vitrage des ouvrants fixes doit être transmis sur la pièce de support de l'ouvrant fixe. Les cales de support (C1) doivent donc être montées à la hauteur de la pièce de support.

En cas de vitrage fixe monorail, on applique les supports dans les angles de la traverse basse pour empêcher que celle-ci ne plie sous le poids du verre (voir schéma monorail).

Afin de simplifier le calage du vitrage, nous disposons de supports de vitrage qui sont utilisés pour égaliser le fond de la feuillure. Sur ces supports on peut utiliser des cales de vitrage rectangulaires.

PROCESSING DATA

I GENERAL

See catalogue "1.General information" (099.C01E.00 edition 11/2004)

II PROCESSING DATA CONCEPT PATIO CP 155 / CP 155-LS

II.1 FABRICATING PRESCRIPTIONS

In order to guarantee a perfect end product, the following guidelines should be adhered to during the production process.

II.1.1 Metal-removing operations

Metal-removing operations are understood to mean all mechanical operations such as sawing, milling, drilling, punching and cutting. For painted profiles it is essential that the paint coatings do not come off on the edges during these operations.

Therefore it is very important for the quality of the connections that:

- the metal-removing tools are appropriate and sufficiently sharp;
- the machines are well adjusted (e.g. number of revolutions);
- the tools are regularly checked;
- The metal-removing tools are greased sufficiently and correctly:
Reynalube cutting grease block (art. no. 086.9191.UN) for saw blades, cutting spray (art. no. 086.9175.UN) for punch tools or the cooling agents and lubricants prescribed by the machine suppliers;
- the appropriate clamp blocks are used;
- the cutting table is free of swarf and dust;
- Possible cooling is done by means of chemically neutral products which do not attack the surface treatment.

Position / clamping of the profiles during cutting:

The position of the profiles on the sawing table during cutting is very important and is the basis to get perfect miters after assembly of the sliding elements.

The biggest clamping pressure should always be on the "reference side" of the profiles.

The "reference side" has to be perfectly horizontally and vertically on the sawing table.

The clamp blocks should possibly be used:

- a. to ensure that tolerances on the profiles do not influence the quality of the mitre;
- b. To ensure that the profiles do not twist on the table.

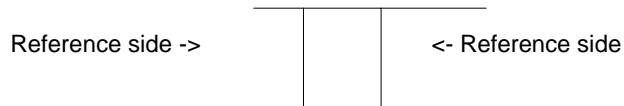

INCORRECT CLAMPING

FAULT: The clamping pressure is on the upper side of the profile, allowing it to twist during cutting.

CONSEQUENCE: An oblique saw cut resulting in the outside of the profile being shorter than the inside.

RESULT: On assembly, the corner is closed on the inside and open on the outside.

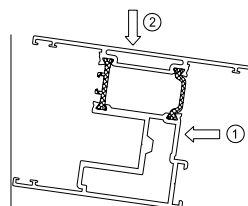

CORRECT CLAMPING

Here, the clamping pressure is on the rebate side of the profile, and the visible side undergoes a smaller secondary pressure.

The profile is prevented from twisting or deforming during cutting. A perfect joint is obtained on assembly.

Remark:

It is recommended to exhaust the swarf during the cutting.

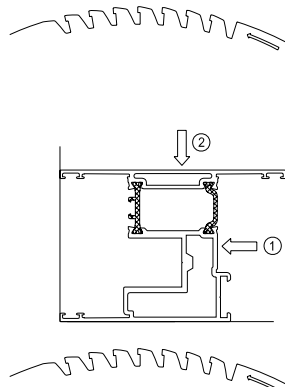

II.1.2

Assembly

We make the following subdivisions:

1. Corner connections;
2. T-brackets;
3. Drainage, aeration and recesses for the accessories;
4. Gaskets.

II.1.2.1 Corner connections

II.1.2.1.1 Crimping

Steps: * option A: glue injection after crimping

** option B: glue injection before crimping

- a. Correct sawing.
- b. * applying holes for glue injection (\varnothing 3.5/4mm)
- c. Protection of the saw cuts and threaded surfaces by:
 - deburring (if necessary);
 - removing dust and saw-dust on the saw cut in the profile chamber;
- d. Degreasing (Reynafinish 60 art. no. 086.9210.--);
- e. Applying Reynaprotector (art. no. 086.9209.--) on the cutting/milling surfaces.
- f. ** Gluing in the profile chamber: applying approved sealing glue (Reynaseal duo art. no. 084.9080.--);
- g. Applying crimp corner cleats and corner supports.
- h. Making the connection and crimping
- i. * Glue injection at the height of the injection holes by means of an approved sealing glue (Reynaseal duo art. no.084.9080.--)
- j. The adhesive residue on the visible sides of the completed elements has to be removed by means of a non-aggressive product (Reynafinish 60 art. no. 086.9210.--).

Remarks:

- To obtain a good sealing of the outer frame a closer should be fitted between the straight corner connection.
 - a. 2-rail hefschuifdeur (CP 155-LS)
 - At bottom and top art. no. 062.9396.--
 - b. 3-rail hefschuifdeur (CP 155-LS)
 - At bottom and top art. no. 062.9399.04
 - c. monorail
 - At bottom art. no. 062.9396.—
 - At top art. no. 062.9392.—
 - d. 2-rail flat bottom
 - At bottom and top art. no. 062.9397.--

II.1.2.1.2 Screwing

Steps:

- a. Correct sawing.
- b. Applying screw holes.
- c. Protection of the saw cuts and threaded surfaces by:
 - deburring (if necessary);
 - removing dust and saw-dust on the saw cut in the profile chamber;
- d. Degreasing (Reynafinish 60 art. no. 086.9210.--);
- e. Applying Reynaprotector (art. no. 086.9209.--) on the cutting/milling surfaces.
- f. Applying screw corner cleats and corner supports.
- g. Making the connection and screwing and pin
- h. The adhesive residue on the visible sides of the completed elements has to be removed by means of a non-aggressive product (Reynafinish 60 art. no. 086.9210.--).

Remarks:

- To obtain a good sealing of the outer frame a closer should be fitted between the straight corner connection.
 - e. 2-rail hefschuifdeur (CP 155-LS)
 - At bottom and top art. no. 062.9396.--
 - f. 3-rail hefschuifdeur (CP 155-LS)
 - At bottom and top art. no. 062.9399.04
 - g. monorail
 - At bottom art. no. 062.9396.—
 - At top art. no. 062.9392.—
 - h. 2-rail flat bottom
 - At bottom and top art. no. 062.9397.--

II.1.2.1.3 Pin

Steps:

- a. Correct sawing.
- b. Applying pin holes..
- c. Protection of the saw cuts and threaded surfaces by:
 - deburring (if necessary);
 - removing dust and saw-dust on the saw cut in the profile chamber;
- d. Degreasing (Reynafinish 60 art. no. 086.9210.--);
- e. Applying Reynaprotector (art. no. 086.9209.--) on the cutting/milling surfaces.
- f. Applying screw corner cleats and corner supports.
- g. Making the connection and pin
- h. The adhesive residue on the visible sides of the completed elements has to be removed by means of a non-aggressive product (Reynafinish 60 art. no. 086.9210.--).

Remarks:

- To obtain a good sealing of the outer frame a closer should be fitted between the straight corner connection.
 - i. 2-rail hefschuifdeur (CP 155-LS)
 - At bottom and top art. no. 062.9396.--
 - j. 3-rail hefschuifdeur (CP 155-LS)
 - At bottom and top art. no. 062.9399.04
 - k. monorail
 - At bottom art. no. 062.9396.—
 - At top art. no. 062.9392.—
 - l. 2-rail flat bottom
 - At bottom and top art. no. 062.9397.--

II.1.2.2 T-brackets

Steps:

- a. Correct sawing of the transom-mullion.
- b. Applying T-connection holes (\varnothing 7mm: inner profile half; \varnothing 3.5mm: outer profile half)
- c. Endmilling of the transom-mullion (height **25** mm)
- d. Protection of the saw cuts and treated surfaces by:
 - deburring (if necessary);
 - removing dust and saw-dust on the saw cut and in the profile chamber;
- e. Degreasing (Reynafinish 60 art. no 086.9210.--);
- f. Applying Reynaprotector (art. no. 086.9209.--).
- g. Sealing of the transom-mullion by applying a neutral sealing agent:
 - on the saw cuts;
 - on the fixing holes;
- h. Sealing of the zone under the trans-mullion on the outer frame by applying sealing elements or a neutral elastic sealing agent.
These parts should be completely watertight. (monorail)

Remark: The area under the transom/mullions may not be completely watertight in order to obtain a controlled drainage of the sliding panel (see pages 34.f. ...).

- i. Making the connection: The T-bracket is positioned on the centre line, the trans-mullion is inserted, and the T-bracket is fixed with screws and driving-in pins (or 2x driving-in pins).
- j. The sealing agent residue on the visible sides of the completed elements has to be removed by means of a non-aggressive product (Reynafinish 60 art. no. 086.9210.--).

II.1.2.3 Drainage and recesses for the accessories

Steps:

- a. Marking of recesses.
- b. Correct punching, drilling or milling.
- c. Protection of the treated surfaces by:
 - Deburring (if necessary);
 - Removing dust and saw-dust on the saw cuts and in the profile chamber.
- d. Degreasing (Reynafinish 60 art. no. 086.9210.--).
- e. Applying Reynaprotector (art. no. 086.9209.--).

Special attentions should be paid to the following regarding drainage / aeration:

Possible infiltrating water must be drained smoothly under control and one must be sure that the profile's chambers remain at the atmospheric pressure.

- For all sliding elements, drainage holes should be a maximum of 250 mm from the corner for the sliding panel and 150 mm for the outer frame. The maximum distance between 2 drainage holes is 800 mm.
Each glazed surface should be provided with min. 2 drainage holes!
- Always drain at the lowest point of the glass rebate.
- All types of sliding elements should be provided with a drainage system in the sills and / or the horizontal transoms.

- The minimum surface of these openings is 50 mm² per opening in the sliding panel, either a round opening of minimum 8 mm diameter, or elongated openings of minimum 5 mm by 15 mm. For the outer frame the minimum surface is 150 mm² per opening, either 3 round openings of minimum 8 mm diameter, or an elongated opening of minimum 8 mm by 34 mm.
- Drainage holes which are visible on the outside of the sliding element are covered with drainage covers in synthetic material.
- All sliding elements are provided with ventilation holes. Its function is to guarantee the pressure equalization around the glazing.
 - o On the side at the top of the sliding panel at least 1 opening of minimum 5 mm should always be drilled.
 - o For fixed panels the outer gasket (080.9114.SY) should be interrupted over a distance of 50 mm.

Remark: For specific drainage we refer to pages 34.f. ...

II.1.2.4 Gaskets

All gaskets are of EPDM resistant to weathering and ageing. They should be carefully applied since the tight sealing of the sliding elements depends on their correct application.

a. Applying the glazing gaskets/gaskets.

Steps:

1. Correct cutting: the glazing gasket should be cut with special gasket shears (art. no. 090.0121.UN) and can be cut straight or mitred according to the kind of profile connection. Extra overhanging (about 10 mm per meter) is required.
2. Application of the gasket: the gaskets are applied in the appropriate grooves within the profiles; they should be cut slightly longer than is necessary to compensate for any shrinkage that may occur. Difficulties in applying the gasket can be solved by the use of silicone spray (art. no. 086.9551.--).
3. Gluing (sealing): in the corners, glazing gaskets should be glued with vulcanizing agent (Unizionement art. no. 084.9103.--). This vulcanizing agent will remain elastic and because of this the gasket will also fit perfectly into the corners.

b. Applying the brushes.

Steps:

1. Correct cutting: the brush should be cut with special gasket shears (art. no. 090.0121.00) and can be cut straight or mitred according to the kind of profile connection.
2. Application of the brush: the brushes are applied in the appropriate grooves within the profiles.
3. Gluing: In function of the type of profile connection (straight), the brush should be glued at the ends with contact glue (Reynaglue art. no. 084.9105.--). This gluing is necessary to avoid the slipping away of the brush.

c. Applying a closer at the bottom and the top of the meeting section.

To obtain a good water tightness, an extra closer should be fitted at the bottom and top of the meeting section:

- 2-rail sliding door (CP 155)
 - At bottom and top art. no. 062.8025.04
- 3-rail sliding door (CP 155)
 - At bottom and top 2x art. no. 062.8025.04
- Monorail sliding door (CP 155)
 - At bottom and top art. no. 062.8027.04
- 2-rail lift & slide door (CP 155-LS)
 - At bottom art. no. 062.8011.04
 - At top art. no. 062.8036.04
- 3-rail lift & slide door (CP 155-LS)
 - At bottom 2x art. no. 062.8011.04
 - At top 2x art. no. 062.8036.04
- Monorail lift & slide door (CP 155-LS)
 - At bottom art. no. 062.8012.04
 - At top art. no. 062.8037.04

The closer at the top has to fit after the panels have been fitted.

II.2 FITTING

II.2.1 Fitting in the structural work

The fixing to the structural work is done either directly through the profiles by means of for instance screws and plugs, or by means of fixing lugs.

- The fixings may not be applied less than 40 mm of the wall of the structural work.
- The anchoring may in no way influence the bearing power of the adjacent building parts.
- All anchorings, as far as they are not made of Aluminium or stainless steel, should be adequately corrosion-protected and may not attack the Aluminium themselves.
- When fitting the sliding elements, sufficient fixings are required:

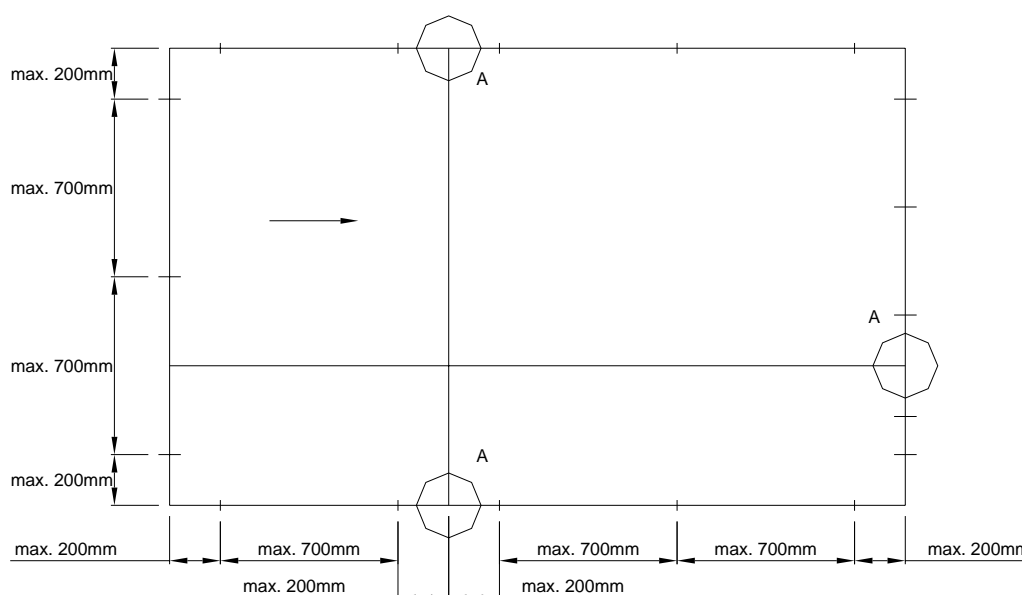

At least two fixings should be applied on all sides; the maximum distance to the corner is at least 200 mm.

- The distance between the fixings is maximum 700 mm.
- Where transom/mullions and outer frame profiles meet, the fixing must be applied maximum 200 mm from both sides of the transom/mullion (A).
In this way, expansion and shrinkage of the transom/mullion (because of fluctuations of temperature) are possible without any damage.
- We recommend to position the fixings at the height of each locking point.

Remark: The anchoring should be applied in such a way that possible expansion / shrinkage of the sliding element is not obstructed.

When screws and plugs are used directly through the profiles, the chambers in the bottom outer frame may not be pierced to avoid water infiltration at the height of this fixing.

II.2.2 Fitting of the accessories

The choice of the fixing points, number of locking points, max. Weight of the sliding panel, max. Sizes of the sliding panel, panel profile used etc. depends on the instructions of the system supplier and the accessory producer.

Sliding and moving parts should be provided with neutral grease.

When fitting, please check whether all accessories can be operated easily and without getting stuck.

II.3 GLAZING

Reynaers' systems are designed for EPDM gasket or neutral silicone glazing. In case of silicone glazing a backing rod should be applied to create a correct opening between the glass panel and the Aluminium frame. For easy and reliable fitting, durability and reglazing simplicity, we recommend using only Reynaers' gaskets – specially adapted for our profiles.

The following precautions should be taken when fitting the glazing:

- Cut the glazing gaskets slightly longer than is necessary to avoid openings in the corners at a later stage.
- Drainage holes should be drilled to avoid build-up moisture. This is also necessary in the case of silicone glazing (see drainage drawings).
- Glass panels should be at least 12 mm (6 mm per side) smaller than the actual measured glazing size.
- The glass supports on the bottom of the glass panel should be sealed (see drawing below).

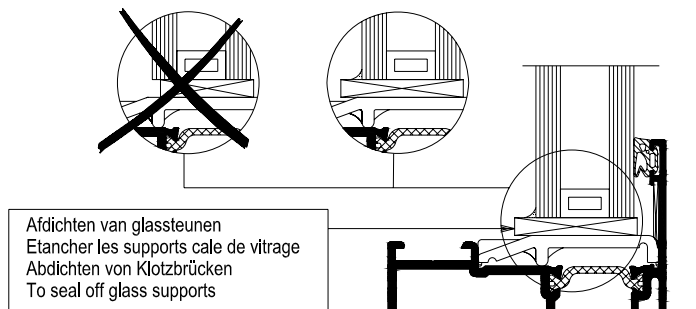

Fitting glass panels.

Glass panels should not come into contact with the Aluminium frame; always use glazing blocks and gaskets.

Wedging prevents this contact and also ensures correct positioning of the glass in the frame, distributing the weight equally onto the rollers to avoid deformation.

In order to simplify fixing of the glazing we dispose of glass supports that can be used to level the bottom of the rebate. In this case it will be possible to apply rectangular glazing blocks.

For double and triple glazing there should be paid extra attention that the glass is supported over the whole panel thickness at all times and that the support blocks (C1) are strong enough to carry the whole glass panel weight.

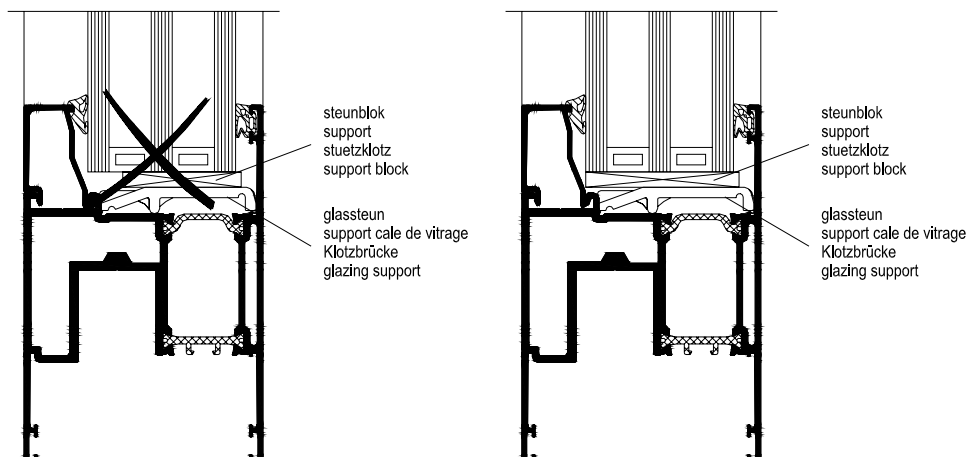

The number and position of the glass supports is defined by the STS 38.

An overview:

There are 2 types of glazing blocks:

support block



adjusting block

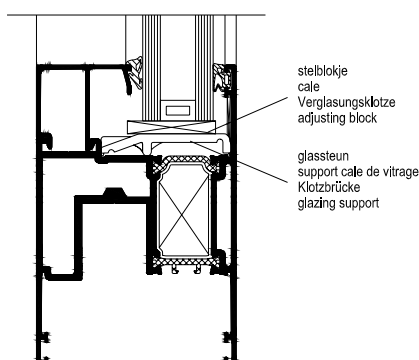

C1: Support blocks

These blocks distribute the weight of the glass onto the sliding panel or the outer frame. Correct positioning is very important for the sliding panel to function correctly.

C2: Adjusting blocks

These blocks guarantee the correct positioning of the glass between the rebates. They must be positioned without twisting or damaging the profile. Adjusting blocks also prevent the glass panels from moving.

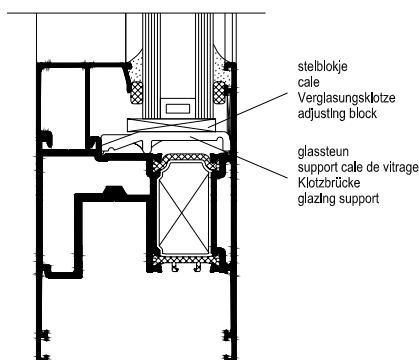

The following sketches indicate the different glazing blocks in different types of sliding elements.

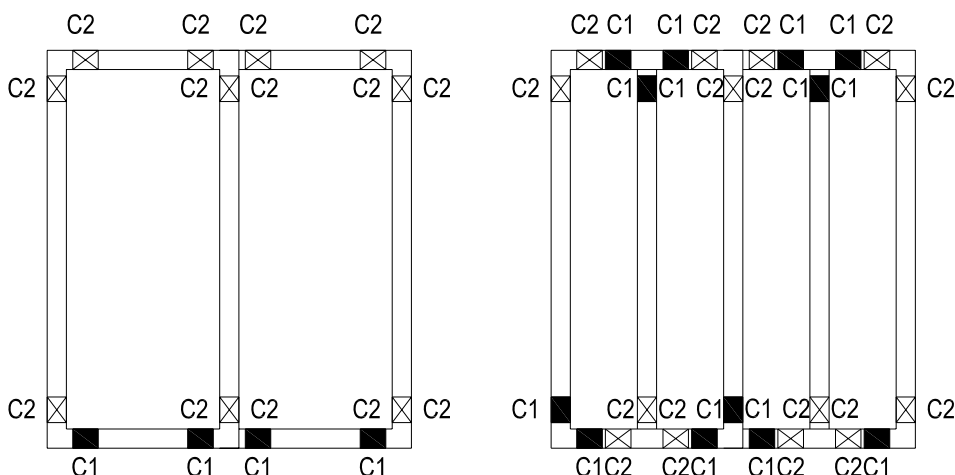

The glass weight of sliding panels should be distributed equally onto the rollers. The support blocks (C1) should consequently be fitted at the height of the rollers.

The glass weight of fixed panels should be distributed onto the support piece of the fixed panel. The support blocks (C1) should consequently be fitted at the height of the support piece.

In fixed glazing monorail, supports are fitted in the corners of the bottom profile to avoid bending due to the weight of the glass (see sketch monorail).

For ease of fitting, we have special glass supports which can be used to equalize the rebate. The rectangular glazing blocks can be placed on these.

VERARBEITUNGSVORSCHRIFTEN

I ALLGEMEIN

Siehe Katalog "1. Allgemeine Information (099.C01E.00 Ausgabe 11/2004)

II VERARBEITUNGSVORSCHRIFTEN CONCEPT PATIO CP 155 / CP 155-LS

II.1 VERARBEITUNG

Um ein qualitativ hochwertiges Endprodukt zu erstellen, sollen bei der Verarbeitung folgende Punkte berücksichtigt werden:

II.1.1 Spanende Bearbeitungen

Mit spanenden Bearbeitungen sind alle mechanischen Bearbeitungen, wie Sägen, Fräsen, Bohren, Stanzen gemeint.

Bei allen mechanischen Bearbeitungen ist auf den Einsatz geeigneter Sägeblätter, Fräser und Bohrer zu achten, damit die Oberfläche nicht durch Grate oder abplatzende Beschichtung beschädigt wird.

Zur Profilbearbeitung geben wir folgende Hinweise:

- Die spanabhebenden Werkzeuge müssen für den Werkstoff geeignet und ausreichend scharf sein.
- Die Maschinendrehzahl muss auf den Werkstoff Aluminium abgestimmt sein.
- Die Profilaufgaben müssen sauber und spanfrei sein.
- Zur Verlängerung der Werkzeugstandzeiten können geeignete Gleitmittel, wie:
 - der Fettstift Reynalube (Art. Nr. 086.9191.UN);
 - das Reynaers-Schneidmittel (Art. Nr. 086.9175.UN);
 - oder die von den Maschinenlieferanten vorgeschriebenen Kühl- und Schneidmittel verwendet werden.
- Die geeignete Spanbacken sollen angewandt werden (Siehe Montagezeichnung „Spanbacken“)
- Der Auflage- und Ablautisch soll frei von Spänen und Verunreinigung sein;
- Diese Kühl- und Schneidmittel müssen chemisch neutrale Produkte sein, die die Oberfläche nicht angreifen.

Zuschnitt:

Der Auflage-/Säge-Tisch sollte eine glatte und ebene Auflagefläche bieten. Der dahinterliegende Anschlag sollte exakt im Winkel von 90° positioniert sein. Auf dem Maschinentisch sollen keine Verunreinigungen, wie Sägespäne oder Kleberreste vorhanden sein. Eine Fixierung der Profile erfolgt mittels Hand- oder pneumatischer Spannzylinder, welche von oben und von vorne auf das Profil wirken.

Ein Verdrehen der Profile während des Sägevorganges ist durch den Einsatz von Schneidzulagen zu verhindern.

Bezugsseite ->

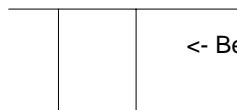

<- Bezugsseite

FALSCH EINSpanNUNG

FEHLER: Da der Hauptdruck der Spannvorrichtung auf die Falzseite des zu sägenden Profils einwirkt, verdreht sich das Werkstück.

FOLGE: Schiefer Sägeschnitt. Die Außenseite des Profils ist länger als die Innenseite.

ERGEBNIS: Beim Verpressen der Profile ist die Gehrung an der Innenseite dicht, steht aber an der Außenseite offen.

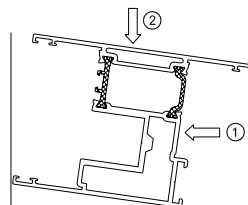

RICHTIGES SPANNEN

Der Hauptdruck der Spannvorrichtung wirkt ein auf die gesamte Fläche. Die Falzseite wird durch eine zweite Spannvorrichtung mit geringerer Kraft gehalten.

Durch diese korrekte Einspannung kann sich das Profil beim Sägevorgang nicht verdrehen.

Die Gehrung wird in der Eckverbindermaschine in der gleichen Art und Weise fixiert, so dass eine exakte Verbindung erreicht wird.

Anmerkung:

Es empfiehlt sich die Späne während des Sägevorganges abzusaugen.

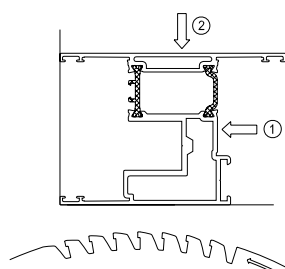
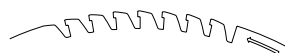

II.1.2 Profilverbindungen und deren Verarbeitung

In den Reynaers-Katalogen wird nach 4 Verarbeitungsschritten unterschieden:

1. Eckverbindungen;
2. T-Verbinder;
3. Entwässerung, Entlüftung und Vorbereitung für den Beschlageinbau;
4. Dichtungen.

II.1.2.1 Eckverbindungen

II.1.2.1.1 Presseckverbinder

Verfahrensweise: * Option A: Leiminjektion nach dem Pressen

** Option B: Leiminjektion vor dem Pressen

- a. Korrekt zuschneiden
- b. * Anbringen von Löchern für Leiminjektion (\varnothing 3.5/4mm)
- c. Schutz der Schnittkanten und bearbeiteten Oberflächen durch:
 - Entgräten (falls erforderlich);
 - Schnittfläche und Profilkammern von Staub und Sägeresten säubern;
- d. Entfetten der Profile (Reynafinish 60 Art. Nr. 086.9210.--);
- e. Korrosionsschutzprodukt (Reynaprotector Art. Nr. 086.9209.--) aufbringen auf Schnittflächen;
- f. ** Klebereinsatz in die Profilkammer: Zweikomponentenkleber (Reynaseal duo Art. Nr. 084.9080.--) einbringen;
- g. Anbringen von Presseckwinkeln und Fülleckwinkeln;
- h. Verbinden und pressen;
- i. Ausgetretener Kleber oder Dichtungsmittelreste müssen von den Sichtseiten entfernt werden (Reynafinish 60 Art. Nr. 086.9210.--).

Bemerkungen:

- Für eine gute Wasserdichtheit des Blendrahmens soll zwischen der geraden Eckverbindung eine Abdichtung eingesetzt werden.
 - a. 2-rail hefschuifdeur (CP 155-LS)
 - unten und oben art. nr. 062.9396.--
 - b. 3-rail hefschuifdeur (CP 155-LS)
 - unten und oben art. nr. 062.9399.04
 - c. monorail
 - unten art. nr. 062.9396.—

- oben art. nr. 062.9392.—
- d. 2-rail flat bottom
- unten und oben art. nr. 062.9397.--

II.1.2.1.2 Schraubeckverbinder

Verfahrensweise:

- a. Korrekt zuschneiden
- b. Anbringen von Schraubenlöcher
- c. Schutz der Schnittkanten und bearbeiteten Oberflächen durch:
 - Entgräten (falls erforderlich);
 - Schnittfläche und Profilkammern von Staub und Sägeresten säubern;
- d. Entfetten der Profile (Reynafinish 60 Art. Nr. 086.9210.--);
- e. Korrosionsschutzprodukt (Reynaprotector Art. Nr. 086.9209.--) aufbringen auf Schnittflächen;
- f. Anbringen von Schraubeckwinkeln und Fülleckwinkeln;
- g. Verbinden und schrauben und stiften;
- h. Ausgetretener Kleber oder Dichtungsmittelreste müssen von den Sichtseiten entfernt werden (Reynafinish 60 Art. Nr. 086.9210.--).

Bemerkungen:

- Für eine gute Wasserdichtheit des Blendrahmens soll zwischen der geraden Eckverbindung eine Abdichtung eingesetzt werden.
- e. 2-rail hefschuifdeur (CP 155-LS)
 - unten und oben art. nr. 062.9396.--
- f. 3-rail hefschuifdeur (CP 155-LS)
 - unten und oben art. nr. 062.9399.04
- g. monorail
 - unten art. nr. 062.9396.—
 - oben art. nr. 062.9392.—
- h. 2-rail flat bottom
 - unten und oben art. nr. 062.9397.--

II.1.2.1.3 Stiften

Verfahrensweise:

- a. Korrekt zuschneiden
- b. Anbringen von Stiftlöcher
- c. Schutz der Schnittkanten und bearbeiteten Oberflächen durch:
 - Entgräten (falls erforderlich);
 - Schnittfläche und Profilkammern von Staub und Sägeresten säubern;
- d. Entfetten der Profile (Reynafinish 60 Art. nr. 086.9210.--);
- e. Korrosionsschutzprodukt (Reynaprotector Art. nr. 086.9209.--) aufbringen auf Schnittflächen;
- f. Anbringen von Schraubeckwinkeln und Fülleckwinkeln;
- g. Verbinden und stiften;
- h. Ausgetretener Kleber oder Dichtungsmittelreste müssen von den Sichtseiten entfernt werden (Reynafinish 60 Art. nr. 086.9210.--).

Bemerkungen:

- Für eine gute Wasserdichtheit des Blendrahmens soll zwischen der geraden Eckverbindung eine Abdichtung eingesetzt werden.
- i. 2-rail hefschuifdeur (CP 155-LS)
 - unten und oben art. nr. 062.9396.--
- j. 3-rail hefschuifdeur (CP 155-LS)
 - unten und oben art. nr. 062.9399.04
- k. monorail
 - unten art. nr. 062.9396.—
 - oben art. nr. 062.9392.—
- l. 2-rail flat bottom
 - unten und oben art. nr. 062.9397.--

II.1.2.2 T-Verbinder

Verfahrensweise:

- a. Korrekt zuschneiden der Sprosse
- b. Anbringen von T-Verbindungsloch (Ø 7mm: inneres Halbprofil; Ø 3.5mm: äußeres Halbprofil)
- c. Abfräsen der Falzhöhe der Sprosse (Höhe **25 mm**)
- d. Schutz der Schnittkanten und bearbeiteten Oberflächen durch:
 - Entgräten (falls erforderlich);
 - Schnittfläche und Profilkammern von Staub und Säureresten säubern;
- e. Entfetten der Profile (Reynafinish Art. nr. 086.9210.--);
- f. Korrosionsschutzprodukt (Reynaprotector Art. nr. 086.9209.--) aufbringen;
- g. Abdichtung: der Bereich im T-Stoß sowie der Bereich der Befestigungsmittel ist durch den Einsatz geeigneter Dichtungsmittel wasserdicht auszuführen;
- h. Abdichten der Zone unter der Sprosse auf dem Blendrahmen durch das Anbringen von Abdichtungselementen oder einem geeigneten Dichtungsmittel. Diese sollen wasserdicht ausgeführt werden. (monorail)

Bemerkung: Der Bereich im T-Stoß darf nicht völlig wasserdicht sein, um eine kontrollierte Entwässerung des Flügels zu bekommen (Siehe Seite 34.f. ...).

- i. Verbinden: nach dem Einbringen des T-Verbinders, der Kleber und Dichtungsmittel, werden die Bauteile zusammengefügt, verstiftet bzw. verschraubt.
- j. Nach dem Zusammenfügen müssen überschüssige Dichtungsmittelreste entfernt werden (Reynafinish Art. Nr. 086.9210.--).

II.1.2.3 Entwässerung und Bearbeitung für den Beschlageinbau

Verfahrensweise:

- a. Die Aussparungen markieren.
- b. Korrekt stanzen, bohren oder fräsen.
- c. Schutz der Schnittkanten:
 - Entgräten (falls erforderlich);
 - Schnittfläche und Profilkammern von Staub und Säureresten säubern;
- d. Entfetten der Profile (Reynafinish Art. Nr. 086.9210.--);
- e. Korrosionsschutzprodukt (Reynaprotector Art. Nr. 086.9209.--) aufbringen;

Insbesondere ist auf folgendes zu achten:

Eventuell eingedrungenes Wasser muss problemlos und kontrolliert abgeleitet werden können. Es sind entsprechende Dampfdruckausgleichsbohrungen vorzunehmen.

- Bei jedem Schiebelement sind Entwässerungsbohrungen vorzunehmen. Diese sitzen max. 250 mm aus der Ecke für den Flügel und 150 mm für den Blendrahmen. Der Abstand zwischen 2 Entwässerungsöffnungen beträgt max. 800 mm. Für jede Glasoberfläche sollen mindestens 2 Entwässerungsbohrungen vorgesehen werden.
- Die Entwässerungsöffnungen sind grundsätzlich am tiefsten Punkt der Profilkontur anzubringen.
- Alle Schiebelemente müssen im Solbankbereich bzw. an den horizontalen T-Profilen mit entsprechenden Ausnehmungen versehen werden.
- Die Mindestoberfläche der Entwässerungsöffnung beträgt 50 mm² pro Öffnung im Flügel, wobei eine Bohrung von mind. 8 mm Durchmesser oder zwei Schlitze von 5 x 15 mm vorzusehen ist. Für den Blendrahmen beträgt die Mindestoberfläche pro Öffnung 150 mm², wobei 3 Bohrungen von mind. 8 mm Durchmesser oder einen Schlitz von 8 x 34 mm vorzusehen ist.
- Alle sichtbaren Entwässerungsöffnungen müssen mit systemabhängigen Kunststoff-Abdeckkappen versehen werden.
- Bei jedem Schiebelement sind grundsätzlich zwei Entlüftungsbohrungen vorzunehmen, damit die Druckegalierung rundum der Verglasung zu gewährleisten.
 - o An der Flügeloberkante ist eine Druckausgleichsöffnung von mind. 5 mm Größe vorzunehmen.
 - o Für feste Flügel muss die äußere Dichtung (080.9114.SY) über einen Abstand von 50 mm unterbrochen werden.

Bemerkung: Spezifische Entwässerungsbohrungen sind gemäß der Seite 34.f. ... vorzunehmen.

II.1.2.4 Dichtungen

Alle angebotenen Dichtungsprofile bestehen aus EPDM mit einer hohen Alterungs- und Witterungsbeständigkeit. Die Verarbeitung der Dichtungen hat sorgfältig und entsprechend den folgenden Hinweisen zu erfolgen:

a. Einbringen der Verglasungsdichtungen/Dichtungen.

Verfahrensweise:

1. Die Verglasungsdichtung wird je nach Erfordernis mit einer speziellen Schere (Art. nr. 090.0121.00) gerade oder auf Gehrung zugeschnitten. Je lfdm. Dichtung ist eine Überlänge von 10 mm hinzuzurechnen.
2. Das Einbringen der Dichtung erfolgt in die vorgesehenen Dichtungsaufnahmen. Beim Einbringen der Dichtungen wird der überlange Zuschnitt durch stauchen der Dichtungsprofile ausgeglichen. Durch die Anwendung des Silikonssprays (Art. nr. 086.9551.--) wird das Einbringen der Dichtungen erleichtert.
3. Die Gehrungs- oder T-Stösse der Dichtungen sollen grundsätzlich mit unserem Vulkanisierkleber (Unzionement Art. nr. 084.9103) verklebt werden

b. Bürstendichtungen.

Verfahrensweise:

1. Die Bürstendichtung wird je nach Erfordernis mit einer speziellen Schere (Art. nr. 090.0121.00) gerade oder auf Gehrung zugeschnitten.
2. Das Einbringen der Dichtung erfolgt in die vorgesehenen Dichtungsaufnahmen.
3. Je nach der Art Profilverbindung (gerade) wird die Bürstendichtung an den Enden mit Sekundenkleber (Reynaglue Art. nr. 084.9105.--) verklebt. Dank dieser Verklebung wird das Ausrutschen der Bürstendichtung vermieden.

c. Abdichtung unten und oben auf dem Wechselprofil.

Für eine gute Wasser- und Winddichtheit soll unten und oben auf dem Wechselprofil eine zusätzliche Abdichtung montiert werden:

- 2-rail Schiebetür (CP 155)
 - unten und oben Art. nr. 062.8025.04
- Monorail Schiebetür (CP 155)
 - unten und oben Art. nr. 062.8027.04
- 2-rail Hebeschiebetür (CP 155-LS)
 - unten Art. nr. 062.8011.04
 - oben Art. nr. 062.8036.04
- Monorail Hebeschiebetür (CP 155-LS)
 - unten Art. nr. 062.8012.04
 - oben Art. nr. 062.8037.04

Die Abdichtung oben muss nach Montage der Flügel montiert werden.

II.2 MONTAGE

II.2.1 Befestigung am Baukörper

Die Befestigung am Baukörper erfolgt durch systemabhängige Befestigungsanker, Rohrrahmendübel oder andere Befestigungsteile. Beim Einsatz von Schrauben und Dübeln ist zu gewährleisten, dass die Mindestrandabstände gemäß den Verarbeitungsrichtlinien der Befestigungshersteller eingehalten werden. Die Verankerung ist so zu wählen, dass die auf das Schiebeelement einwirkenden Lasten sicher an den Baukörper abgeleitet werden. Alle zum Einsatz kommenden Verankerungen sollen aus Aluminium oder Edelstahl bzw. korrosionsgeschützt sein, damit die Aluminiumprofile nicht angegriffen werden.

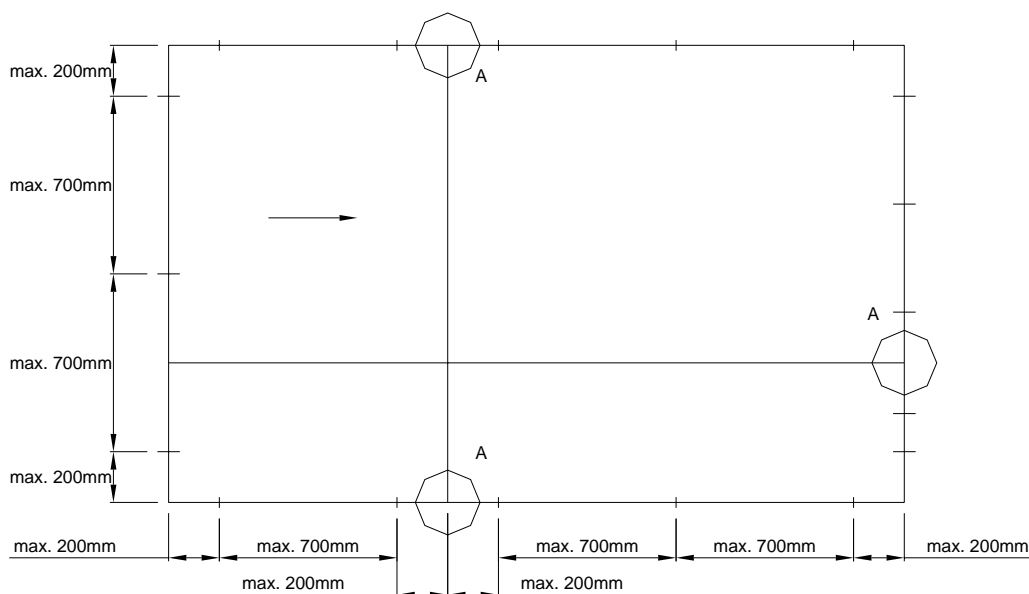

Die Anzahl der Befestigungspunkte ist wie folgt festzulegen:

- Je Rahmenseite müssen mind. zwei Befestigungen eingebracht werden.
- Der max. Abstand zur Rahmenecke darf 200 mm nicht unterschreiten.
- Der max. Abstand der Befestigungspunkte untereinander darf 700 mm nicht unterschreiten.
- Im Bereich von Pfosten- und Riegelanschluss sind die Befestigungspunkte ebenfalls 200 mm aus der Ecke vorzunehmen. Es wird empfohlen, die Befestigungspunkte in den Bereich der Eck- und Scherenlager sowie in den Bereich der Verriegelungspunkte (des Schlosses) zu legen.

Anmerkung: Die Befestigungen sollen so angebracht werden, dass ein eventuelles Arbeiten der Aluminiemelemente aufgenommen werden kann. Beim Einsatz von Schrauben und Dübeln durch die Profile dürfen die Kammern im Unterblendrahmen nicht durchbohrt werden um Wassereindringung im Bereich dieser Befestigung zu vermeiden.

II.2.2 Einbau der Beschläge

Die Auswahl der Beschläge hat entsprechend den Vorgaben des Systemlieferanten bzw. des Herstellers der Beschläge zu erfolgen. Die hier angegebenen Werte bzgl. der max. Flügelabmessungen, des max. Flügelgewichtes, der Anzahl der Verschlusspunkte sind einzuhalten. Bewegliche Teile sind, entsprechend den Angaben des Beschlagherstellers, mit säurefreiem Fett zu versehen. Eine Funktionsprüfung der Beschläge ist nach erfolgter Fertigung und Montage unerlässlich.

II.3 VERGLASUNG

Alle unsere Systeme sind für die Verglasung mit EPDM-Silikonkautschuke konzipiert. Bei Silicon Verglasung sollte eingesetzt werden, um einen Geldgeber Stange, um eine Lücke zwischen der Glasplatte und Aluminium Rahmen korrigieren. Wir empfehlen die Verwendung unserer speziell entwickelten, Verglasung Gummis zu benutzen. Die Verglasung wird dies schneller und zuverlässiger laufen, im Laufe der Zeit haltbar, und beschädigte Glasscheiben werden einfach ausgetauscht werden.

In der Verglasung sollte berücksichtigt werden, die folgenden Punkte:

- Weil der Gummi-Kompression ist zu vermeiden, dass dann Öffnungen in den Ecken auftreten.
- Entwässerung Löcher gebohrt, um Wasseransammlungen vermieden werden. Es ist auch notwendig in Silikon Verglasung (siehe Drainage Zeichnungen).
- Um Platz das Glas ist zu berücksichtigen mit einem Mindestabstand von 12 mm auf dem Aluminium-Rahmen (6 mm pro Seite) entnommen werden.
- Das Glas Unterstützung auf der Unterseite der Glasplatte sollte es dicht (Siehe Diagramm unten).

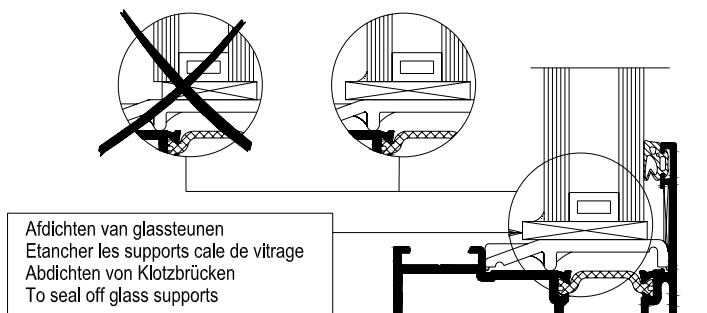

Damit die Befestigung erleichtert wird, kommen Glasauflageprofile (Klotzbrücken) zur Ausführung, um den Falzbereich auszugleichen. Rechteckige Verglasungsklotze können jetzt eingebracht werden.

Bei Doppelt- oder Dreidoppeltverglasung soll darauf geachtet werden, dass die Glasdicke vollständig unterstützt wird und, dass die Stützklotze genügend stark sind damit das vollständige Glassgewicht zu tragen.

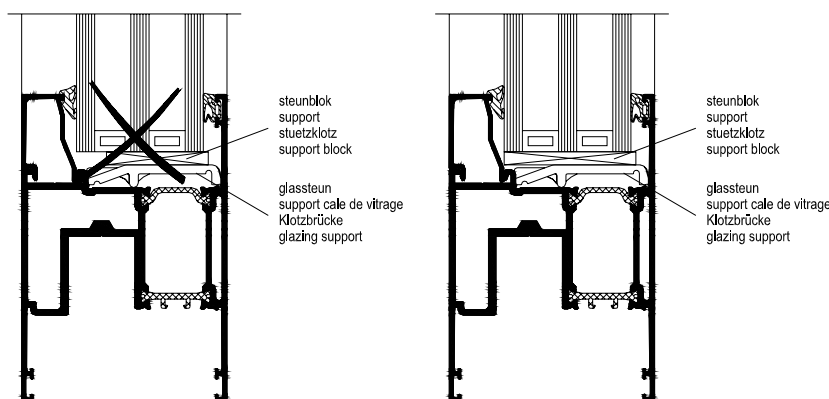

Die Anzahl und die Position der Klotzbrücken bzw. Verglasungsklotze wird durch Verarbeitungsvorschriften der Isolierglasindustrie und technische Richtlinien des Glaserhandwerks vorgegeben.

Übersicht:

Bei der Verglasung unterscheiden wir nach Trag- und Distanzklötzen. Die Verglasungsklötze sind gegen Verrutschen zu sichern:

Tragklötze



Distanzklötze

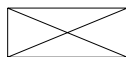

C1: Die Tragklötze

übertragen das Scheibengewicht auf den Rahmen bzw. Flügel und stellen die Gangbarkeit der beweglichen Flügel sicher.

C2: Die Distanzklötze

stellen den Abstand zwischen Rahmen und Verglasung sicher. Je nach Flügelöffnungsart können diese auch eine tragende Funktion übernehmen.

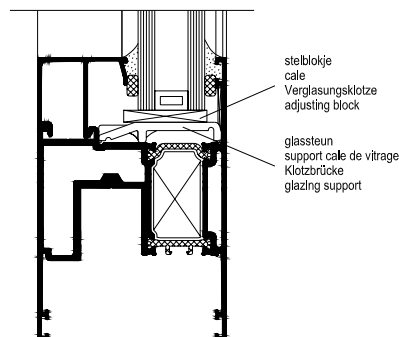
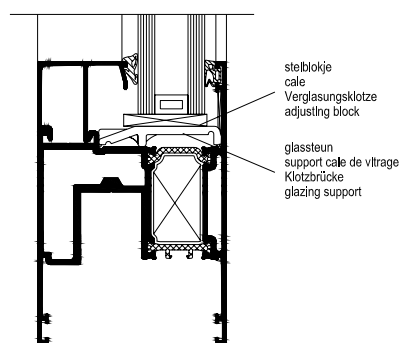

Die Anzahl und Position der Klotzbrücken bzw. Verglasungsklötze wird durch Verarbeitungsvorschriften der Isolierglasindustrie und den Technischen Richtlinien des Glaserhandwerks vorgegeben.

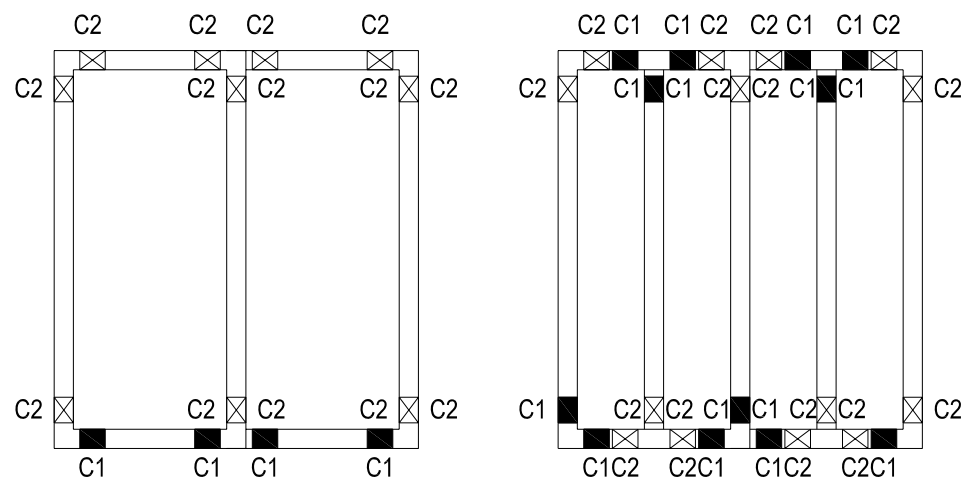

Nachstehend eine Übersicht über den Sitz und die Anzahl der Verglasungsklötze in den verschiedenen Typen von Schiebeelementen.

Bei schiebenden Flügeln wird das Scheibengewicht auf die Laufwagen übertragen. Die Verglasungsklötze (C1) müssen also im Bereich der Laufwagen montiert werden.

Bei festen Flügeln wird das Scheibengewicht auf die Stütze des festen Flügels übertragen. Die Verglasungsklötze (C1) müssen also im Bereich dieser Stütze montiert werden.

<p>2-rail XO</p>	<p>Monorail XQ</p>
<p>2-rail XQ</p>	<p>Monorail XQQ</p>
<p>2-rail XQQ</p>	<p>Monorail QXXQ</p>
<p>2-rail OXXO</p>	<p>3-rail XXO</p>
<p>2-rail QXXQ</p>	<p>3-rail XXQ</p>
<p>Transom-Mullion</p>	

<p>2-rail XX</p> 	<p>Monorail XQ</p> 
<p>2-rail XQ</p> 	<p>Monorail QXX</p> 
<p>2-rail QXX</p> 	<p>Monorail QXXQ</p> 
<p>2-rail QXQ</p> 	<p>3-rail XXX</p> 
<p>2-rail XXXX</p> 	<p>3-rail XXQ</p> 
<p>2-rail QXXQ</p> 	<p>Transom-Mullion</p> 
	

2-RAIL XQ

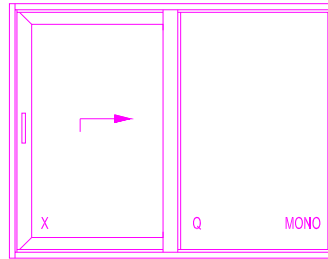

2-RAIL QXQ

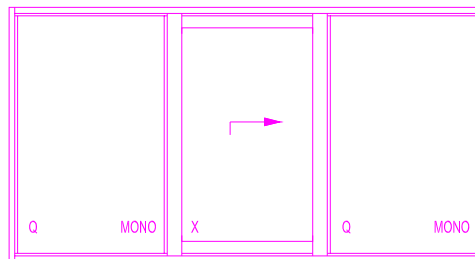

2-RAIL XQX

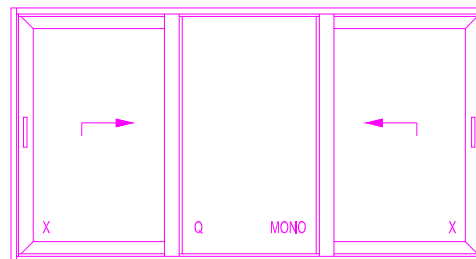

2-RAIL QXXQ

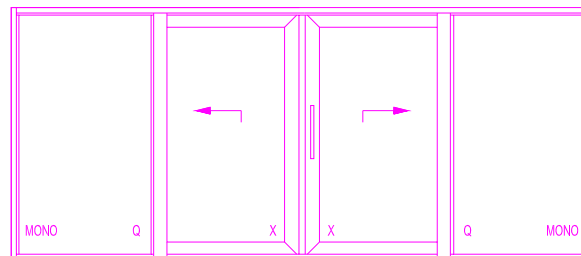

U_f of CP 155 combinations, according to EN 10077-2				
Section	Profiles	W [mm]	Uf [W/m²K]	
			Standard	HI
Glazing thickness: 24mm (Calculated with real glass covering)			Updated* 03/03/2011	
CP 155				
1	006.1300.XX+006.2340.XX	154	2.88	2.39
2	006.2340.XX+006.2340.XX	115	3.76	3.39
2	006.2340.XX+006.2340.XX+006.1343.XX	115	4.54	
3	006.1300.XX+006.2340.XX	154	3.08	2.82
4	006.1300.XX+006.2340.XX+006.0360.XX	154	2.65	2.16
5	006.2340.XX+006.0345.XX+006.2340.XX	210	3.22	2.53
6	008.3113.XX	76	2.50	2.07
6	008.3120.XX	89	2.42	2.02
6	008.3114.XX	102	2.35	1.97
6	008.3123.XX	115	2.29	1.93
9	006.1300.XX+006.2340.XX	154	3.11	2.92
11	006.1300.XX+006.2340.XX	154	2.92	2.77
12	006.1300.XX+006.2340.XX	154	3.20	3.04
13	006.1300.XX+006.2340.XX	154	2.94	2.39
14	006.1300.XX+006.2340.XX	154	3.25	2.87
15	006.1300.XX+006.2340.XX+006.0360.XX	154	2.67	2.52
16	006.1300.XX+006.2340.XX	154	3.13	3.08
17	006.1300.XX+006.2340.XX+006.0360.XX	154	2.70	2.14
18	006.1300.XX+006.2340.XX	154	3.14	2.86
71	006.1400.XX+006.2340.XX	154	2.90	2.41
72	006.1400.XX+006.2340.XX	154	3.14	3.10
73	006.1400.XX+006.2340.XX	154	3.09	2.83
74	006.1400.XX+006.2340.XX	154	3.25	2.87
75	006.1400.XX+006.2340.XX	154	2.93	2.78
76	006.1400.XX+006.2340.XX	154	2.53	2.40
77	006.1400.XX+006.2340.XX	154	2.99	2.66
78	006.1400.XX+006.2340.XX	154	2.56	2.11
79	006.1400.XX+006.2340.XX	154	3.12	2.85
84	006.1400.XX+006.2340.XX	154	3.20	2.86
87	006.1400.XX+006.2340.XX	154	2.95	2.41
88	006.1400.XX+006.2340.XX	154	2.56	2.11
CP 155 Mono				
2	006.2340.XX+006.2340.XX	115	3.76	3.39
2	006.2340.XX+006.2340.XX+006.1343.XX	115	4.54	
5	006.2340.XX+006.0345.XX+006.2340.XX	210	3.22	2.53
6	008.3113.XX	76	2.50	2.07
6	008.3120.XX	89	2.42	2.02
6	008.3114.XX	102	2.35	1.97
6	008.3123.XX	115	2.29	1.93
51	006.0320.XX+006.2340.XX	154	4.64	4.33
53	006.0320.XX	60	2.89	2.52
61	006.0320.XX+006.2340.XX	154	4.53	4.43
62	006.0320.XX	60	2.89	2.53
63	006.0320.XX+006.2340.XX	154	4.56	4.20
64	006.0320.XX	60	2.89	2.52
*	Check for details at the last page: "Updates"			

U_f of CP 155 LS combinations, according to EN 10077-2				
Section	Profiles	W [mm]	Uf [W/m²K]	
			Standard	HI
Glazing thickness: 24mm (Calculated with real glass covering)			Updated* 03/03/2011	
CP 155-LS				
2	006.2340.XX+006.2340.XX	115	3.76	3.39
2	006.2340.XX+006.2340.XX+006.3430.XX	115	4.54	
6	008.3113.XX	76	2.50	2.07
6	008.3120.XX	89	2.42	2.02
6	008.3114.XX	102	2.35	1.97
6	008.3123.XX	115	2.29	1.93
8	006.2340.XX+006.2340.XX+006.1346.XX	115	5.28	4.51
8	006.2340.XX+006.2340.XX+006.1346.XX+006.1343.XX	115	6.56	
101	006.1306.XX+006.2340.XX	162	2.77	2.14
103	006.1306.XX+006.2340.XX	162	2.93	2.42
105	006.2340.XX+006.0345.XX+006.2340.XX	210	3.22	2.53
111	006.1302.XX+006.2340.XX	164	2.85	2.68
112	006.1302.XX+006.2340.XX	164	3.09	2.94
113	006.0317.XX+006.0318.XX+006.2340.XX_FB	114	3.26	2.69
113	006.1300.XX+006.2340.XX	154	2.91	2.39
114	006.0317.XX+006.0318.XX+006.2340.XX_FB	114	3.80	3.46
114	006.1300.XX+006.2340.XX	154	3.10	2.85
115	006.0317.XX+006.0318.XX+006.2340.XX_FB	114	3.26	2.69
115	006.1300.XX+006.2340.XX	154	2.68	2.16
116	006.0317.XX+006.0318.XX+006.2340.XX_FB	114	3.73	3.24
116	006.1300.XX+006.2340.XX	154	3.11	2.84
171	006.1406.XX+006.2340.XX	162	2.75	2.14
172	006.1402.XX+006.2340.XX	164	3.06	2.90
173	006.1406.XX+006.2340.XX	162	2.82	2.35
174	006.1400.XX+006.2340.XX	154	3.10	2.92
175	006.1402.XX+006.2340.XX	164	2.84	2.67
176	006.1402.XX+006.2340.XX	164	2.40	2.23
177	006.1400.XX+006.2340.XX	154	2.93	2.42
178	006.1400.XX+006.2340.XX	154	2.57	2.10
184	006.1400.XX+006.2340.XX	154	3.11	2.85
187	006.1400.XX+006.2340.XX	154	2.93	2.41
188	006.1400.XX+006.2340.XX	154	2.54	2.10
CP 155-LS Mono				
2	006.2340.XX+006.2340.XX	115	3.76	3.39
2	006.2340.XX+006.2340.XX+006.3430.XX	115	4.54	
6	008.3113.XX	76	2.50	2.07
6	008.3120.XX	89	2.42	2.02
6	008.3114.XX	102	2.35	1.97
6	008.3123.XX	115	2.29	1.93
105	006.2340.XX+006.0345.XX+006.2340.XX	210	3.22	2.53
151	006.0324.XX+006.2340.XX	147	4.82	4.44
153	006.0326.XX	60	2.87	2.47
161	006.1322.XX+006.2340.XX	154	4.61	4.52
162	006.1322.XX	60	2.50	2.05
163	006.0320.XX+006.2340.XX	154	4.57	4.25
164	006.0320.XX	60	2.90	2.52
*	Check for details at the last page: "Updates"			

<i>U_f of CP 155-LS/Hi, Minergie combinations, according to EN 10077-2</i>			
Section	Profiles	W [mm]	U_f [W/m²K]
<i>Glazing thickness: 43mm (Calculated with real glass covering)</i>		Created 03/03/2011	
CP 155-LS/Hi, Minergie			
202	006.2340.XX+006.0350.XX	115	2.86
203	006.2340.XX+006.0350.XX+006.1346.XX	115	3.64
205	006.2340.XX+006.0345.XX+006.2340.XX	210	2.47
251	006.0325.XX+006.2340.XX	172	1.94
253	006.0327.XX	60	1.37
261	006.0323.XX+006.2340.XX	160	2.35
262	006.0323.XX	66	1.07
263	006.0321.XX+006.2340.XX	154	2.00
264	006.0321.XX	63	1.12

IV CE-PASSPORT CP155

IV.1 GENERAL EXPLANATION ABOUT CLASSIFICATIONS

The different characteristics have been determined in accordance with EN 14351-1 (Windows and doors - Product standard, performance characteristics - Part 1: Windows and external pedestrian doorsets without resistance to fire and/or smoke leakage characteristics).

The numbers in the following tables (e.g. 4.2; 4.3,...) refer to the different chapters from EN 14351-1 which describe the different performance characteristics.

The classifications given in the next tables give the most general classifications and the test reports which are used to declare these characteristics. Other dimensions and/or other classifications are sometimes possible. When other requirements are necessary, please contact your Reynaers office.

It is evident that lower (worse) values than those indicated can be declared without further testing.

E.g. when wind load was tested till 1600Pa (class C4) also class C3 (1200Pa) or lower can be declared.

The tests were carried out in collaboration with Notified Bodies as indicated in EN 14351-1.

In IV.2 details about the Notified Bodies are given.

The different configurations are indicated in the table in chapter 3.

IV.2 NOTIFIED BODIES

SKG – notified body nr.0960
Nieuwe Kanaal 9F
Wageningen
Netherlands

Ift-Rosenheim – notified body nr. 0757
Theodor Gietl Strasse 7-9
D 83026 Rosenheim
Germany

ITB – notified body nr. 1488
ul. Ksawerów 21
02-656 Warszawa
Poland

BBRI – notified body nr. 1136
Rue du Lombard 42 Lombardstraat 42
1000 BRUXELLES-BRUSSEL
Belgium

Ghent University – Testcentre for Wall elements (RUG) – notified body nr. 1769
Sint-Pietersnieuwstraat 41
9000 GENT
Belgium

IV.3 Opening type

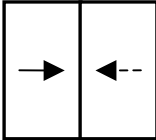
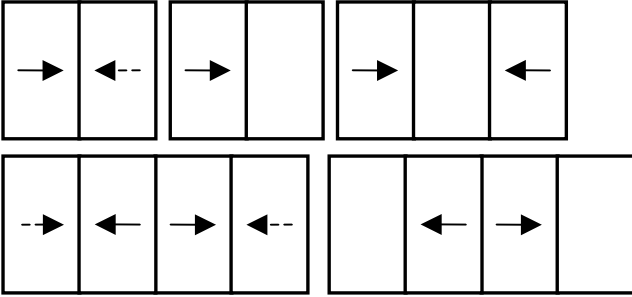
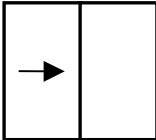
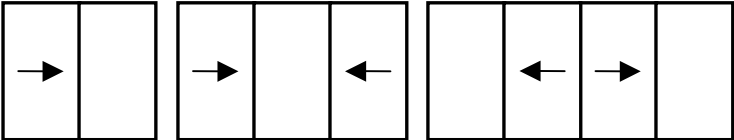
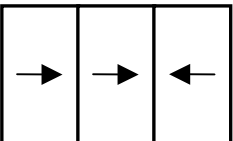
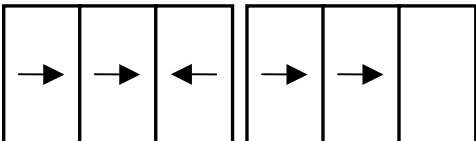
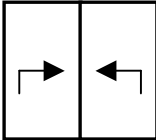
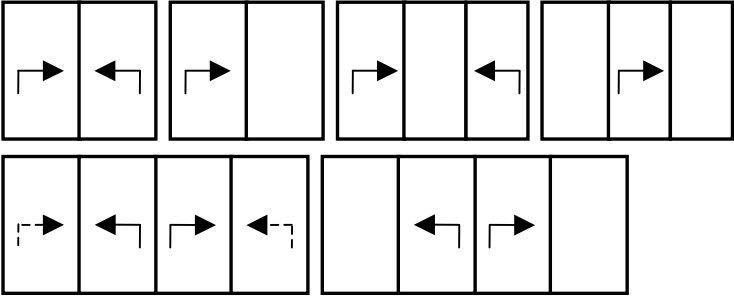
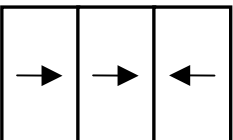
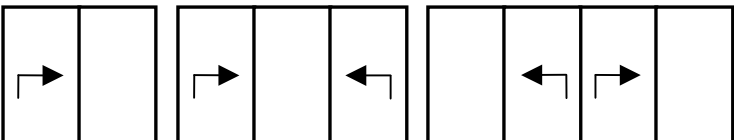
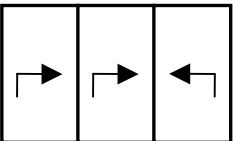
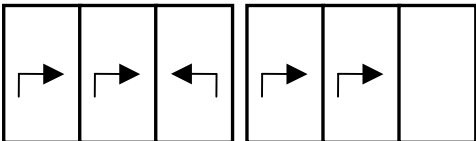
	Opening type	Covered variants
type S1	 <p>Slide</p>	
type S2	 <p>Monorail slide</p>	
type S3	 <p>3 rail slide</p>	
type S4	 <p>Lift Slide</p>	
type S5	 <p>Monorail lift slide</p>	
type S6	 <p>3 rail lift slide</p>	

IV.4 CHARACTERISTICS/CLASSIFICATIONS

Classifications for sliding door type S1 (Slide)

No	Characteristic	Classification	Notified body - Report	Limits (mm)								
4.2	Resistance to wind load (EN 12210)	C3 (1200Pa)	SKG – 08.1061	W<3115 H<2510								
4.4	Reaction to fire	Npd										
4.5	Watertightness (EN 12208)	8A (450Pa)	SKG – 08.1061	W<3115 H<2510								
4.6	Dangerous substances	In the materials delivered by Reynaers, no dangerous substances as indicated in EN14351-1 are used										
4.7	Impact resistance (EN 13049)	5 ⁽¹⁾	SKG – 10.0099									
4.8	Loadbearing capacity of safety devices (EN 14609)	Npd										
4.9	Height and width	Height: Width:	For definition: see Rule for definition of clear opening height and width									
4.11	Acoustic performance (EN ISO 140-3 & EN ISO 717-1)	<table border="1"> <thead> <tr> <th>Glass</th> <th>Window</th> </tr> <tr> <th>R_w(C;C_{tr})</th> <th>R_w(C;C_{tr})</th> </tr> </thead> <tbody> <tr> <td>34(-1;-4) → 35(-2;-4)</td> <td rowspan="3">lft – 162 34130/3</td> </tr> <tr> <td>41(-2;-4) → 37(-1;-2)</td> </tr> <tr> <td>50(-2;-8) → 40(0;-2)</td> </tr> </tbody> </table>	Glass	Window	R _w (C;C _{tr})	R _w (C;C _{tr})	34(-1;-4) → 35(-2;-4)	lft – 162 34130/3	41(-2;-4) → 37(-1;-2)	50(-2;-8) → 40(0;-2)		Tested overall area: 6.7m ² , other dimensions see extrapolation rules
Glass	Window											
R _w (C;C _{tr})	R _w (C;C _{tr})											
34(-1;-4) → 35(-2;-4)	lft – 162 34130/3											
41(-2;-4) → 37(-1;-2)												
50(-2;-8) → 40(0;-2)												
4.12	Thermal transmittance (EN ISO 10077-1)	U _w to be calculated in function of the project. Pre-calculated U-values for dimensions 2000*2180mm are added to this document. U _f -values are calculated under certification of BCCA. Certificate BPCD-420-072-EN 10077-2 REYN-01										
4.13	Radiation properties (EN 410)	These properties must be evaluated by the CE-label of the glass										
4.14	Air permeability (EN 12207)	4	SKG – 08.1061	W<3115 H<2510								
4.16	Operating forces (EN 12217)	1	RUG – 363/2519	W<3200 H<2200								
4.17	Mechanical strength (EN 1192)	1	RUG – 363/2519	W<3200 H<2200								
4.18	Ventilation	Npd										
4.19	Bullet resistance (EN 1522)	Npd										
4.20	Explosion resistance (EN 13123-1 & EN 13123-2)	Npd										
4.21	Resistance to repeated opening and closing (EN 12400)	ongoing										
4.22	Behaviour between different climates (ENV 13420)	Npd										
4.23	Burglar resistance (ENV 1627)	Class 2	PIV – 23-8/09	(2)								

*Always check maximum dimensions graphs in catalogue. Other dimensions or classifications are possible: in this case please contact Reynaers

*W=Width, H=Height

(1): Impact resistance only valid with tubular or L-shaped glazing beads

(2): Not for 4 pane slider.

Classifications for sliding door type S2 (Monorail slide)

No	Characteristic	Classification	Notified body - Report	Limits (mm)										
4.2	Resistance to wind load (EN 12210)	C4 (1600Pa)	SKG – 08.1059	W<3100 H<2500										
4.4	Reaction to fire	Npd												
4.5	Watertightness (EN 12208)	7A (300Pa)	SKG – 08.1059	W<3100 H<2500										
4.6	Dangerous substances	In the materials delivered by Reynaers, no dangerous substances as indicated in EN14351-1 are used												
4.7	Impact resistance (EN 13049)	5⁽¹⁾	SKG – 10.0099											
4.8	Loadbearing capacity of safety devices (EN 14609)	Npd												
4.9	Height and width	Height: Width:	For definition: see Rule for definition of clear opening height and width											
4.11	Acoustic performance (EN ISO 140-3 & EN ISO 717-1)	<table border="1"> <thead> <tr> <th>Glass</th> <th>Window</th> </tr> <tr> <th>$R_w(C;C_{tr})$</th> <th>$R_w(C;C_{tr})$</th> </tr> </thead> <tbody> <tr> <td>34(-1;-4)</td> <td>→ 35(-2;-4)</td> </tr> <tr> <td>41(-2;-4)</td> <td>→ 37(-1;-2)</td> </tr> <tr> <td>50(-2;-8)</td> <td>→ 40(0;-2)</td> </tr> </tbody> </table>	Glass	Window	$R_w(C;C_{tr})$	$R_w(C;C_{tr})$	34(-1;-4)	→ 35(-2;-4)	41(-2;-4)	→ 37(-1;-2)	50(-2;-8)	→ 40(0;-2)	ift – 162 34130/3	Tested overall area: 6.7m ² , other dimensions see extrapolation rules
Glass	Window													
$R_w(C;C_{tr})$	$R_w(C;C_{tr})$													
34(-1;-4)	→ 35(-2;-4)													
41(-2;-4)	→ 37(-1;-2)													
50(-2;-8)	→ 40(0;-2)													
4.12	Thermal transmittance (EN ISO 10077-1)	U _w to be calculated in function of the project. Pre-calculated U-values for dimensions 2000*2180mm are added to this document. U _f -values are calculated under certification of BCCA. Certificate BPCD-420-072-EN 10077-2 REYN-01												
4.13	Radiation properties (EN 410)	These properties must be evaluated by the CE-label of the glass												
4.14	Air permeability (EN 12207)	4	SKG – 08.1059	W<3100 H<2500										
4.16	Operating forces (EN 12217)	1	RUG – 363/2519	W<3200 H<2200										
4.17	Mechanical strength (EN 1192)	1	RUG – 363/2519	W<3200 H<2200										
4.18	Ventilation	Npd												
4.19	Bullet resistance (EN 1522)	Npd												
4.20	Explosion resistance (EN 13123-1 & EN 13123-2)	Npd												
4.21	Resistance to repeated opening and closing (EN 12400)	Ongoing												
4.22	Behaviour between different climates (ENV 13420)	Npd												
4.23	Burglar resistance (ENV 1627)													

*Always check maximum dimensions graphs in catalogue. Other dimensions or classifications are possible: in this case please contact Reynaers

*W=Width, H=Height

(1): Impact resistance only valid with tubular or L-shaped glazing beads

Classifications for sliding door type S3 (3 rail slide)

No	Characteristic	Classification	Notified body - Report	Limits (mm)						
4.2	Resistance to wind load (EN 12210)	C3 (1200Pa)	SKG – 08.1061	Vent: WxH <1550x2510						
4.4	Reaction to fire	Npd								
4.5	Watertightness (EN 12208)	8A (450Pa)	SKG – 08.1061	Vent: WxH <1550x2510						
4.6	Dangerous substances	In the materials delivered by Reynaers, no dangerous substances as indicated in EN14351-1 are used								
4.7	Impact resistance (EN 13049)	5 ⁽¹⁾	SKG – 10.0099							
4.8	Loadbearing capacity of safety devices (EN 14609)	Npd								
4.9	Height and width	Height: Width:	For definition: see Rule for definition of clear opening height and width							
4.11	Acoustic performance (EN ISO 140-3 & EN ISO 717-1)	<table border="1"> <thead> <tr> <th>Glass R_w(C;C_{tr})</th> <th>Window R_w(C;C_{tr})</th> </tr> </thead> <tbody> <tr> <td>34(-1;-4) → 35(-2;-4)</td> <td rowspan="3">ift – 162 34130/3</td> </tr> <tr> <td>41(-2;-4) → 37(-1;-2)</td> </tr> <tr> <td>50(-2;-8) → 40(0;-2)</td> </tr> </tbody> </table>	Glass R _w (C;C _{tr})	Window R _w (C;C _{tr})	34(-1;-4) → 35(-2;-4)	ift – 162 34130/3	41(-2;-4) → 37(-1;-2)	50(-2;-8) → 40(0;-2)		Tested overall area: 6.7m ² , other dimensions see extrapolation rules
Glass R _w (C;C _{tr})	Window R _w (C;C _{tr})									
34(-1;-4) → 35(-2;-4)	ift – 162 34130/3									
41(-2;-4) → 37(-1;-2)										
50(-2;-8) → 40(0;-2)										
4.12	Thermal transmittance (EN ISO 10077-1)	U _w to be calculated in function of the project. U _f -values are calculated under certification of BCCA. Certificate BPCD-420-072-EN 10077-2 REYN-01								
4.13	Radiation properties (EN 410)	These properties must be evaluated by the CE-label of the glass								
4.14	Air permeability (EN 12207)	4	SKG – 08.1061	Vent: WxH <1550x2510						
4.16	Operating forces (EN 12217)	1	RUG – 363/2519	Vent: WxH <1550x2200						
4.17	Mechanical strength (EN 1192)	1	RUG – 363/2519	Vent: WxH <1550x2200						
4.18	Ventilation	Npd								
4.19	Bullet resistance (EN 1522)	Npd								
4.20	Explosion resistance (EN 13123-1 & EN 13123-2)	Npd								
4.21	Resistance to repeated opening and closing (EN 12400)	ongoing								
4.22	Behaviour between different climates (ENV 13420)	Npd								
4.23	Burglar resistance (ENV 1627)									

*Always check maximum dimensions graphs in catalogue. Other dimensions or classifications are possible: in this case please contact Reynaers

*W=Width, H=Height

(1): Impact resistance only valid with tubular or L-shaped glazing beads

Classifications for sliding door type S4 (Lift Slide)

No	Characteristic	Classification	Notified body - Report	Limits (mm)						
4.2	Resistance to wind load (EN 12210)	C3 (1200Pa) C2 (800Pa)	SKG – 08.1051 SKG – 10.1045	WxH<3115x2510 WxH<4000x4000						
4.4	Reaction to fire	Npd								
4.5	Watertightness (EN 12208)	E900 (900Pa) 7A(450Pa)	SKG – 08.1051 SKG – 10.1045	WxH<3115x2510 WxH<4000x4000						
4.6	Dangerous substances	In the materials delivered by Reynaers, no dangerous substances as indicated in EN14351-1 are used								
4.7	Impact resistance (EN 13049)	5 ⁽¹⁾	SKG – 10.0099							
4.8	Loadbearing capacity of safety devices (EN 14609)	Npd								
4.9	Height and width	Height: Width:	For definition: see Rule for definition of clear opening height and width							
4.11	Acoustic performance (EN ISO 140-3 & EN ISO 717-1)	<table border="1"> <thead> <tr> <th>Glass</th> <th>Window</th> </tr> </thead> <tbody> <tr> <td>34(-1;-4) → 35(-2;-5)</td> <td rowspan="3">ift – 162 34130/4</td> </tr> <tr> <td>41(-2;-4) → 38(-1;-3)</td> </tr> <tr> <td>50(-2;-8) → 42(-1;-3)</td> </tr> </tbody> </table>	Glass	Window	34(-1;-4) → 35(-2;-5)	ift – 162 34130/4	41(-2;-4) → 38(-1;-3)	50(-2;-8) → 42(-1;-3)	Tested overall area: 6.7m ² , other dimensions see extrapolation rules	
Glass	Window									
34(-1;-4) → 35(-2;-5)	ift – 162 34130/4									
41(-2;-4) → 38(-1;-3)										
50(-2;-8) → 42(-1;-3)										
4.12	Thermal transmittance (EN ISO 10077-1)	Uw to be calculated in function of the project. Pre-calculated U-values for dimensions 2000*2180mm are added to this document. Uf-values are calculated under certification of BCCA. Certificate BPCD-420-072-EN 10077-2 REYN-01								
4.13	Radiation properties (EN 410)	These properties must be evaluated by the CE-label of the glass								
4.14	Air permeability (EN 12207)	4 4	SKG – 08.1051 SKG – 10.1045	WxH<3115x2510 WxH<4000x4000						
4.16	Operating forces (EN 12217)	2	RUG – 363/2513	WxH<4000x3000						
4.17	Mechanical strength (EN 1192)	1	RUG – 363/2513	WxH<4000x3000						
4.18	Ventilation	Npd								
4.19	Bullet resistance (EN 1522)	Npd								
4.20	Explosion resistance (EN 13123-1 & EN 13123-2)	Npd								
4.21	Resistance to repeated opening and closing (EN 12400)	Ongoing								
4.22	Behaviour between different climates (ENV 13420)	Npd								
4.23	Burglar resistance (ENV 1627)	Class 2	PIV – 23-8/09	(2)						

*Always check maximum dimensions graphs in catalogue. Other dimensions or classifications are possible: in this case please contact Reynaers

*W=Width, H=Height

(1): Impact resistance only valid with tubular or L-shaped glazing beads

(2): Not for 4 pane slider.

Classifications for sliding door type S5 (Monorail lift slide) CP155 & Minergie

No	Characteristic	Classification	Notified body - Report	Limits (mm)						
4.2	Resistance to wind load (EN 12210)	C3 (1200Pa)	SKG – 10.1131 Rev.A	WxH<4500*2300						
4.4	Reaction to fire	Npd								
4.5	Watertightness (EN 12208)	9A (600Pa)	SKG – 10.1131 Rev.A	WxH<4500*2300						
4.6	Dangerous substances	In the materials delivered by Reynaers, no dangerous substances as indicated in EN14351-1 are used								
4.7	Impact resistance (EN 13049)	5 ⁽¹⁾								
4.8	Loadbearing capacity of safety devices (EN 14609)	Npd								
4.9	Height and width	Height: Width:	For definition: see Rule for definition of clear opening height and width							
4.11	Acoustic performance (EN ISO 140-3 & EN ISO 717-1)	<table border="1"> <thead> <tr> <th>Glass</th> <th>Window</th> </tr> </thead> <tbody> <tr> <td>34(-1;-4) → 35(-2;-5)</td> <td rowspan="3">lft – 162 34130/4</td> </tr> <tr> <td>41(-2;-4) → 38(-1;-3)</td> </tr> <tr> <td>50(-2;-8) → 42(-1;-3)</td> </tr> </tbody> </table>	Glass	Window	34(-1;-4) → 35(-2;-5)	lft – 162 34130/4	41(-2;-4) → 38(-1;-3)	50(-2;-8) → 42(-1;-3)	Tested overall area: 6.7m ² , other dimensions see extrapolation rules	
Glass	Window									
34(-1;-4) → 35(-2;-5)	lft – 162 34130/4									
41(-2;-4) → 38(-1;-3)										
50(-2;-8) → 42(-1;-3)										
4.12	Thermal transmittance (EN ISO 10077-1)	Uw to be calculated in function of the project. Pre-calculated U-values for dimensions 2000*2180mm are added to this document. Uf-values are calculated under certification of BCCA. Certificate BPCD-420-072-EN 10077-2 REYN-01								
4.13	Radiation properties (EN 410)	These properties must be evaluated by the CE-label of the glass								
4.14	Air permeability (EN 12207)	4	SKG – 10.1131 Rev.A	WxH<4500*2300						
4.16	Operating forces (EN 12217)	2	RUG – 363/2513	WxH<4000x3000						
4.17	Mechanical strength (EN 1192)	1	RUG – 363/2513	WxH<4000x3000						
4.18	Ventilation	Npd								
4.19	Bullet resistance (EN 1522)	Npd								
4.20	Explosion resistance (EN 13123-1 & EN 13123-2)	Npd								
4.21	Resistance to repeated opening and closing (EN 12400)	Ongoing								
4.22	Behaviour between different climates (ENV 13420)	Npd								
4.23	Burglar resistance (ENV 1627)	Npd								

*Always check maximum dimensions graphs in catalogue. Other dimensions or classifications are possible: in this case please contact Reynaers

*W=Width, H=Height

Classifications for sliding door type S6 (3 rail lift slide)

No	Characteristic	Classification	Notified body - Report	Limits (mm)						
4.2	Resistance to wind load (EN 12210)	C3 (1200Pa) C2 (800Pa)	SKG – 08.1051 SKG – 10.1045	Vent: WxH<1550x2510 WxH<2000x4000						
4.4	Reaction to fire	Npd								
4.5	Watertightness (EN 12208)	E900 (900Pa) 7A(450Pa)	SKG – 08.1051 SKG – 10.1045	Vent: WxH<1550x2510 WxH<2000x4000						
4.6	Dangerous substances	In the materials delivered by Reynaers, no dangerous substances as indicated in EN14351-1 are used								
4.7	Impact resistance (EN 13049)	5 ⁽¹⁾	SKG – 10 .0099							
4.8	Loadbearing capacity of safety devices (EN 14609)	Npd								
4.9	Height and width	Height: Width:	For definition: see Rule for definition of clear opening height and width							
4.11	Acoustic performance (EN ISO 140-3 & EN ISO 717-1)	<table border="1"> <thead> <tr> <th>Glass</th> <th>Window</th> </tr> </thead> <tbody> <tr> <td>34(-1;-4) → 35(-2;-5)</td> <td rowspan="3">lft – 162 34130/4</td> </tr> <tr> <td>41(-2;-4) → 38(-1;-3)</td> </tr> <tr> <td>50(-2;-8) → 42(-1;-3)</td> </tr> </tbody> </table>	Glass	Window	34(-1;-4) → 35(-2;-5)	lft – 162 34130/4	41(-2;-4) → 38(-1;-3)	50(-2;-8) → 42(-1;-3)	Tested overall area: 6.7m ² , other dimensions see extrapolation rules	
Glass	Window									
34(-1;-4) → 35(-2;-5)	lft – 162 34130/4									
41(-2;-4) → 38(-1;-3)										
50(-2;-8) → 42(-1;-3)										
4.12	Thermal transmittance (EN ISO 10077-1)	U _w to be calculated in function of the project. U _f -values are calculated under certification of BCCA. Certificate BPCD-420-072-EN 10077-2 REYN-01								
4.13	Radiation properties (EN 410)	These properties must be evaluated by the CE-label of the glass								
4.14	Air permeability (EN 12207)	4 4	SKG – 08.1051 SKG – 10.1045	Vent: WxH<1550x2510 WxH<2000x4000						
4.16	Operating forces (EN 12217)	2	RUG – 363/2513	Vent: WxH<2000x3000						
4.17	Mechanical strength (EN 1192)	1	RUG – 363/2513	Vent: WxH<2000x3000						
4.18	Ventilation	Npd								
4.19	Bullet resistance (EN 1522)	Npd								
4.20	Explosion resistance (EN 13123-1 & EN 13123-2)	Npd								
4.21	Resistance to repeated opening and closing (EN 12400)	Ongoing								
4.22	Behaviour between different climates (ENV 13420)	Npd								
4.23	Burglar resistance (ENV 1627)									

*Always check maximum dimensions graphs in catalogue. Other dimensions or classifications are possible: in this case please contact Reynaers

*W=Width, H=Height

(1): Impact resistance only valid with tubular or L-shaped glazing beads

Extrapolation rules for acoustical values

For doors with other dimensions as the tested doors, the measured values must be corrected with the values as indicated in following table.

Size range	Sound insulation for door
-100% to +50% of test specimen overall area	Rw and Rw + Ctr as tested
+50% to +100% of test specimen overall area	Correct Rw and Rw + Ctr with -1 dB
+100% to +150% of test specimen overall area	Correct Rw and Rw + Ctr with -2 dB
>150% of test specimen overall area	Correct Rw and Rw + Ctr with -3 dB

Rule for definition of clear opening height and width

The clear opening height g and clear opening width a are defined as indicated in following sketches out of EN 12519:2004

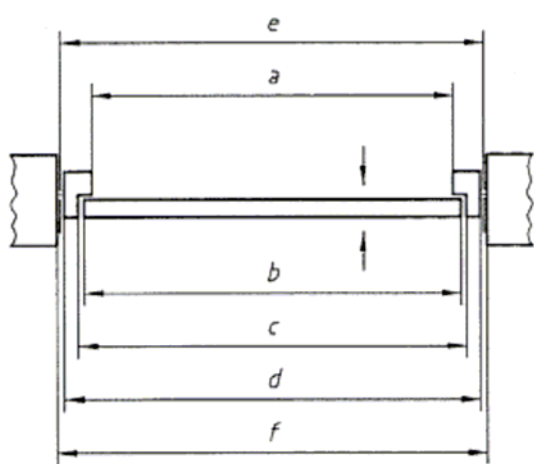

Figure 1/Figure 1/Bild 1

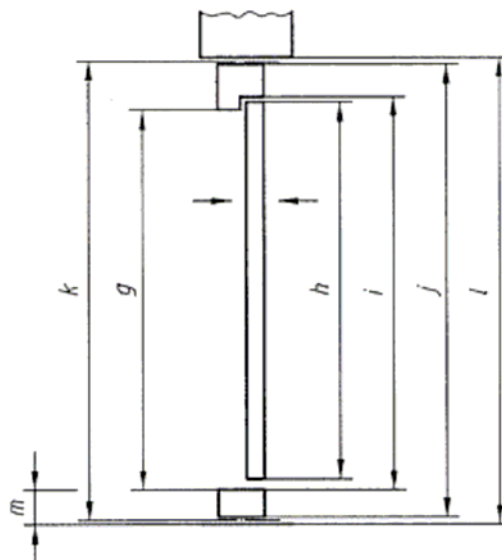

Figure 2/Figure 2/Bild 2

IV.5 THERMAL TRANSMITTANCE

These U-values are pre-calculated Uw-values for specific profile combinations. Uw-values of windows with other profile combinations can be calculated using the formulas from EN ISO 10077-1 and using the Uf-values from our separate Uf-value table for this system.

Thermal transmittance CP155																	
Ud - values are calculated according to EN ISO 10077-1:2006 for a sliding door with dimensions 2000*2180mm as indicated in EN 14351-1																	
Sliding door type S1 (slide) for outerframe-vent: 006.1300+006.2340, meeting section 2x006.2340																	
psi	↓	Ug =>	0.6	0.7	0.8	0.9	1.0	1.1	1.2	1.3	1.4	1.5	1.6	1.7	1.8	1.9	2.8
0.11	Ud =>	1.7	1.8	1.8	1.9	2.0	2.0	2.1	2.2	2.2	2.3	2.4	2.4	2.4	2.5	2.6	3.2
0.08	Ud =>	1.6	1.7	1.7	1.8	1.9	2.0	2.0	2.1	2.2	2.2	2.3	2.4	2.4	2.4	2.5	3.1
0.06	Ud =>	1.6	1.6	1.7	1.8	1.8	1.9	2.0	2.0	2.1	2.2	2.2	2.3	2.4	2.4	2.4	3.1
Sliding door type S2 (monorail slide) for outerframe-vent: 006.0320+006.2340, meeting section 2x006.2340																	
psi	↓	Ug =>	0.6	0.7	0.8	0.9	1.0	1.1	1.2	1.3	1.4	1.5	1.6	1.7	1.8	1.9	2.8
0.11	Ud =>	1.7	1.8	1.9	2.0	2.0	2.1	2.2	2.2	2.3	2.3	2.4	2.5	2.6	2.6	2.7	3.4
0.08	Ud =>	1.7	1.7	1.8	1.9	2.0	2.0	2.1	2.2	2.3	2.3	2.4	2.5	2.6	2.6	2.6	3.3
0.06	Ud =>	1.6	1.7	1.8	1.8	1.9	2.0	2.1	2.1	2.2	2.3	2.4	2.4	2.5	2.6	2.6	3.3
Sliding door type S4 (lift slide) for outerframe-vent: 006.1306+006.2340, meeting section 2x006.2340																	
psi	↓	Ug =>	0.6	0.7	0.8	0.9	1.0	1.1	1.2	1.3	1.4	1.5	1.6	1.7	1.8	1.9	2.8
0.11	Ud =>	1.7	1.7	1.8	1.9	1.9	2.0	2.1	2.1	2.1	2.2	2.3	2.3	2.4	2.5	2.5	3.1
0.08	Ud =>	1.6	1.7	1.7	1.8	1.9	1.9	2.0	2.1	2.1	2.1	2.2	2.3	2.3	2.4	2.5	3.1
0.06	Ud =>	1.6	1.6	1.7	1.8	1.8	1.9	2.0	2.0	2.1	2.2	2.2	2.3	2.4	2.4	2.4	3.0
Sliding door type S5 (monorail lift slide) for outerframe-vent: 006.0324+006.2340, meeting section 2x006.2340																	
psi	↓	Ug =>	0.6	0.7	0.8	0.9	1.0	1.1	1.2	1.3	1.4	1.5	1.6	1.7	1.8	1.9	2.8
0.11	Ud =>	1.7	1.8	1.9	2.0	2.0	2.1	2.2	2.3	2.3	2.4	2.5	2.6	2.6	2.7	2.7	3.4
0.08	Ud =>	1.7	1.7	1.8	1.9	2.0	2.0	2.1	2.2	2.3	2.3	2.4	2.5	2.6	2.6	2.6	3.3
0.06	Ud =>	1.6	1.7	1.8	1.8	1.9	2.0	2.1	2.1	2.2	2.3	2.4	2.4	2.5	2.6	2.6	3.3
Thermal transmittance CP155-HI																	
Ud - values are calculated according to EN ISO 10077-1:2006 for a sliding door with dimensions 2000*2180mm as indicated in EN 14351-1																	
Sliding door type S1 (slide) for outerframe-vent: 006.1300+006.2340, meeting section 2x006.2340																	
psi	↓	Ug =>	0.6	0.7	0.8	0.9	1.0	1.1	1.2	1.3	1.4	1.5	1.6	1.7	1.8	1.9	2.8
0.11	Ud =>	1.6	1.6	1.7	1.8	1.8	1.9	2.0	2.0	2.1	2.2	2.3	2.3	2.4	2.5	2.5	3.1
0.08	Ud =>	1.5	1.6	1.6	1.7	1.8	1.8	1.9	2.0	2.0	2.1	2.2	2.2	2.3	2.4	2.4	3.0
0.06	Ud =>	1.5	1.5	1.6	1.7	1.7	1.8	1.9	1.9	2.0	2.1	2.1	2.2	2.3	2.3	2.3	2.9
Sliding door type S2 (monorail slide) for outerframe-vent: 006.0320+006.2340, meeting section 2x006.2340																	
psi	↓	Ug =>	0.6	0.7	0.8	0.9	1.0	1.1	1.2	1.3	1.4	1.5	1.6	1.7	1.8	1.9	2.8
0.11	Ud =>	1.7	1.7	1.8	1.9	2.0	2.0	2.1	2.2	2.3	2.3	2.4	2.5	2.6	2.6	2.6	3.3
0.08	Ud =>	1.6	1.7	1.7	1.8	1.9	2.0	2.0	2.1	2.2	2.3	2.3	2.4	2.5	2.6	2.6	3.2
0.06	Ud =>	1.5	1.6	1.7	1.8	1.8	1.9	2.0	2.1	2.1	2.2	2.3	2.4	2.4	2.5	2.5	3.2
Sliding door type S4 (lift slide) for outerframe-vent: 006.1306+006.2340, meeting section 2x006.2340																	
psi	↓	Ug =>	0.6	0.7	0.8	0.9	1.0	1.1	1.2	1.3	1.4	1.5	1.6	1.7	1.8	1.9	2.8
0.11	Ud =>	1.5	1.6	1.7	1.7	1.8	1.9	1.9	2.0	2.1	2.1	2.2	2.3	2.3	2.4	2.4	3.0
0.08	Ud =>	1.5	1.5	1.6	1.7	1.7	1.8	1.9	2.0	2.1	2.1	2.2	2.3	2.3	2.3	2.3	2.9
0.06	Ud =>	1.4	1.5	1.5	1.6	1.7	1.7	1.8	1.9	1.9	2.0	2.1	2.1	2.1	2.2	2.3	2.9
Sliding door type S5 (monorail lift slide) for outerframe-vent: 006.0324+006.2340, meeting section 2x006.2340																	
psi	↓	Ug =>	0.6	0.7	0.8	0.9	1.0	1.1	1.2	1.3	1.4	1.5	1.6	1.7	1.8	1.9	2.8
0.11	Ud =>	1.6	1.7	1.8	1.9	1.9	2.0	2.1	2.2	2.3	2.3	2.4	2.5	2.6	2.6	2.6	3.3
0.08	Ud =>	1.6	1.6	1.7	1.8	1.9	1.9	2.0	2.1	2.2	2.3	2.4	2.5	2.6	2.6	2.6	3.2
0.06	Ud =>	1.5	1.6	1.7	1.7	1.8	1.9	2.0	2.0	2.1	2.2	2.3	2.4	2.4	2.5	2.5	3.2
Thermal transmittance CP155-LS/Hi Minergie																	
Ud - values are calculated according to EN ISO 10077-1:2006 for a sliding door with dimensions 2000*2180mm as indicated in EN 14351-1																	
Sliding door type S5 (monorail lift slide) for outerframe-vent: 006.0325+006.2340, meeting section 006.2340+006.0350																	
psi	↓	Ug =>	0.6	0.7	0.8	0.9	1.0	1.1	1.2	1.3	1.4	1.5	1.6	1.7	1.8	1.9	2.8
0.11	Ud =>	1.3	1.3	1.4	1.5	1.5	1.6	1.7	1.8	1.8	1.9	1.9	2.0	2.1	2.1	2.2	2.9
0.08	Ud =>	1.2	1.2	1.3	1.4	1.5	1.5	1.6	1.7	1.8	1.8	1.9	2.0	2.1	2.1	2.1	2.8
0.06	Ud =>	1.1	1.2	1.3	1.3	1.4	1.5	1.6	1.6	1.7	1.8	1.9	1.9	2.0	2.1	2.1	2.8

U-values based on U-value table for CP155/CP155-LS dated 03/03/2011

C







Profielen

Profilés

Profiles

Profile

Art. N°			Art. N°		
001.0260.XX	34.C.036	D0044306	030.3608.XX	34.C.036	D0044306
004.3130.XX	34.C.039	D0013865	030.3609.XX	34.C.036	D0044306
004.3167.XX	34.C.040	D0013864	030.3610.XX	34.C.036	D0044306
004.3168.XX	34.C.041	D0090319	030.3611.XX	34.C.036	D0044306
004.3843.XX	34.C.039	D0013865	030.3612.XX	34.C.037	D0083806
005.0276.XX	34.C.036	D0044306	030.3613.XX	34.C.037	D0083806
006.0305.04	34.C.012	D0013847	030.3614.XX	34.C.037	D0083806
006.0317.XX	34.C.050	D0074761	030.3615.XX	34.C.037	D0083806
006.0318.XX	34.C.050	D0074761	030.3616.XX	34.C.037	D0083806
006.0320.XX	34.C.013	D0013848	030.3617.XX	34.C.037	D0083806
006.0321.XX	34.C.019	D0084595	030.3618.XX	34.C.037	D0083806
006.0323.XX	34.C.020	D0084596	030.3619.XX	34.C.037	D0083806
006.0324.XX	34.C.014	D0013849	030.3644.XX	34.C.038	D0013859
006.0325.XX	34.C.021	D0084597	030.3645.XX	34.C.038	D0013859
006.0326.XX	34.C.014	D0013849	030.3646.XX	34.C.038	D0013859
006.0327.XX	34.C.022	D0084598	030.3647.XX	34.C.038	D0013859
006.0335.00	34.C.026	D0013854	030.3648.XX	34.C.038	D0013859
006.0345.XX	34.C.026	D0013854	030.3649.XX	34.C.038	D0013859
006.0350.XX	34.C.034	D0084599	030.3650.XX	34.C.038	D0013859
006.0351.XX	34.C.048	D0084600	030.3890.XX	34.C.046	D0013868
006.0360.XX	34.C.008	D0013843	043.1028.XX	34.C.045	D0013867
006.0362.XX	34.C.015	D0013850	0K8.3824.XX	34.C.033	D0013858
006.0363.XX	34.C.015	D0013850	0M0.1505.XX	34.C.027	D0013853
006.0365.XX	34.C.049	D0059657	103.0081.04	34.C.023	D0084601
006.0366.XX	34.C.023	D0084601			
006.0370.XX	34.C.045	D0013867			
006.0371.XX	34.C.044	D0013866			
006.1300.XX	34.C.008	D0013843			
006.1301.04	34.C.008	D0013843			
006.1302.XX	34.C.009	D0013844			
006.1303.04	34.C.009	D0013844			
006.1304.XX	34.C.011	D0013846			
006.1306.XX	34.C.010	D0013845			
006.1322.XX	34.C.013	D0013848			
006.1341.04	34.C.027	D0013853			
006.1342.XX	34.C.027	D0013853			
006.1343.00	34.C.027	D0013853			
006.1346.XX	34.C.035	D0046576			
006.1400.XX	34.C.016	D0044533			
006.1402.XX	34.C.017	D0044575			
006.1406.XX	34.C.018	D0044579			
006.2340.XX	34.C.024	D0013851			
006.2344.XX	34.C.025	D0013852			
007.0767.01	34.C.050	D0074761			
008.3113.XX	34.C.030	D0013856			
008.3114.XX	34.C.031	D0013857			
008.3120.XX	34.C.030	D0013856			
008.3123.XX	34.C.032	D0075003			
008.3824.XX	34.C.033	D0013858			
008.3848.XX	34.C.043	D0075000			
009.1886.XX	34.C.045	D0013867			
011.4631.--	34.C.008	D0013843			
030.0080.XX	34.C.042	D0074999			
030.0138.00	34.C.044	D0013866			
030.1096.00	34.C.028	D0013855			
030.1097.00	34.C.028	D0013855			
030.1098.00	34.C.028	D0013855			
030.1099.XX	34.C.029	D0090318			
030.1135.XX	34.C.051	D0084234			
030.1142.XX	34.C.040	D0013864			
030.1143.XX	34.C.039	D0013865			
030.1147.XX	34.C.041	D0090319			
030.2140.00	34.C.047	D0013869			
030.2141.00	34.C.047	D0013869			
030.3097.XX	34.C.028	D0013855			
030.3099.XX	34.C.028	D0013855			
030.3200.XX	34.C.036	D0044306			
030.3370.XX	34.C.046	D0013868			
030.3606.XX	34.C.036	D0044306			
030.3607.XX	34.C.036	D0044306			

CP 155
CP 155-LS

PROFIELLIJST
LISTE DES PROFILES
LIST OF PROFILES
PROFILLISTE



CP 155
CP 155-LS

PROFIELOVERZICHT
APERCU DES PROFILES
PROFILE OVERVIEW
PROFILUEBERSICHT



CP 155 CP 155-LS

PROFIELOVERZICHT
APERCU DES PROFILS
PROFILE OVERVIEW
PROFILUEBERSICHT



BUITENKADER DORMANT OUTER FRAME BLENDRAHMEN

			$\frac{A}{dm^2/m}$	$\frac{P}{dm^2/m}$	$\leftarrow L_m \rightarrow$	$I_x \text{ cm}^4$	$I_y \text{ cm}^4$
006.1300.XX			54.70	21.3	7.00 4.80	216.247	53.752

006.1302.XX			55.33	23.3	7.00 4.80	256.789	57.868
-------------	--	--	-------	------	--------------	---------	--------

006.1306.XX			48.97	18.3	6.00 3.00	198.518	34.118
-------------	--	--	-------	------	--------------	---------	--------

006.0317.XX			18.81	6.2	7.00	1.532	7.627
-------------	--	--	-------	-----	------	-------	-------

006.0318.XX			26.03	7.9	7.00	1.889	20.289
-------------	--	--	-------	-----	------	-------	--------

007.0767.01					7.00	-	-
-------------	--	--	--	--	------	---	---

BUITENKADER MONORAIL DORMANT MONORAIL OUTER FRAME MONORAIL BLENDRAHMEN MONORAIL

			$\frac{A}{dm^2/m}$	$\frac{P}{dm^2/m}$	$\leftarrow L_m \rightarrow$	$I_x \text{ cm}^4$	$I_y \text{ cm}^4$
006.0320.XX			55.13	21.0	7.00 4.80	162.919	38.929

006.1322.XX			54.27	24.4	7.00 4.80	191.947	35.798
-------------	--	--	-------	------	--------------	---------	--------

006.0324.XX			55.23	25.9	6.50 3.50	142.471	21.055
-------------	--	--	-------	------	--------------	---------	--------

			$\frac{A}{dm^2/m}$	$\frac{P}{dm^2/m}$	$\leftarrow L_m \rightarrow$	$I_x \text{ cm}^4$	$I_y \text{ cm}^4$
006.0326.XX			48.06	18.7	6.50 3.50	130.938	16.774

BUITENKADER 3-RAIL DORMANT 3-RAIL OUTER FRAME 3-RAIL BLENDRAHMEN 3-RAIL

			$\frac{A}{dm^2/m}$	$\frac{P}{dm^2/m}$	$\leftarrow L_m \rightarrow$	$I_x \text{ cm}^4$	$I_y \text{ cm}^4$
006.1400.XX			82.08	24.4	7.00	900.669	78.297

006.1402.XX			85.04	24.7	7.00	829.127	79.003
-------------	--	--	-------	------	------	---------	--------

006.1406.XX			69.12	22.3	6.00	642.510	47.461
-------------	--	--	-------	------	------	---------	--------

VLEUGEL OUVRANT VENT FLUEGEL

			$\frac{A}{dm^2/m}$	$\frac{P}{dm^2/m}$	$\leftarrow L_m \rightarrow$	$I_x \text{ cm}^4$	$I_y \text{ cm}^4$
006.2340.XX			50.36	19.1	7.00 4.80	39.302	36.652

PROFIEL BUITENKADER KUNSTSTOF
PROFILE SYNTHETIQUE DORMANT
SYNTHETIC PROFILE OUTER FRAME
KUNSTSTOFFPROFIL BLENDRAHMEN

			$\frac{A}{dm^2/m}$	$\frac{P}{dm^2/m}$	$\leftarrow L_m \rightarrow$	$I_x \text{ cm}^4$	$I_y \text{ cm}^4$
006.1301.04			-	-	7.00	-	-
006.1303.04			-	-	7.00	-	-
006.0305.04			-	-	6.00	-	-

AFDEKPROFIEL BUITENKADER
PROFILE DE RECOUVREMENT DORMANT
COVERING PROFILE OUTER FRAME
ABDECKPROFIL BLENDRAHMEN

			$\frac{A}{dm^2/m}$	$\frac{P}{dm^2/m}$	$\leftarrow L_m \rightarrow$	$I_x \text{ cm}^4$	$I_y \text{ cm}^4$
006.0362.XX			26.70	11.6	7.00	19.939	2.111
006.0363.XX			26.68	11.5	7.00	17.193	1.880
006.0360.XX			32.02	11.2	7.00	21.640	1.875

WISSELPROFIEL
CHICANE
MEETING SECTION
WECHSELPROFIL

			$\frac{A}{dm^2/m}$	$\frac{P}{dm^2/m}$	$\leftarrow L_m \rightarrow$	$I_x \text{ cm}^4$	$I_y \text{ cm}^4$
006.1342.XX			25.11	9.7	6.00 3.00	18.817	0.568
006.1341.04			-	-	6.00	1.437	6.678

			$\frac{A}{dm^2/m}$	$\frac{P}{dm^2/m}$	$\leftarrow L_m \rightarrow$	$I_x \text{ cm}^4$	$I_y \text{ cm}^4$
006.1346.XX			45.10	12.3	6.00	73.951	14.650

GELEIDINGSRAIL
RAIL DE GUIDAGE
GUIDE RAIL
FUEHRUNGSSCHIENE

			$\frac{A}{dm^2/m}$	$\frac{P}{dm^2/m}$	$\leftarrow L_m \rightarrow$	$I_x \text{ cm}^4$	$I_y \text{ cm}^4$
011.4631.--			-	-	7.00	-	-

T-PROFIEL
TRAVERSE
TRANSOM-MULLION
SPROSSE

			$\frac{A}{dm^2/m}$	$\frac{P}{dm^2/m}$	$\leftarrow L_m \rightarrow$	$I_x \text{ cm}^4$	$I_y \text{ cm}^4$
008.3113.XX			34.24	11.0	7.00 5.00	16.916	8.602
008.3120.XX			38.23	13.6	7.00 5.00	21.513	16.299
008.3114.XX			40.81	16.2	7.00 5.00	25.337	28.302
008.3123.XX			43.41	18.8	7.00	29.162	45.435
008.3824.XX			50.00	26.6	7.00	59.548	142.536
0K8.3824.XX			50.00	26.3	1.15	59.548	142.536

RECHTHOEKIGE STAAF
BARRE RECTANGULAIRE
RECTANGULAR BAR
FLACHPROFIL

			$\frac{A}{dm^2/m}$	$\frac{P}{dm^2/m}$	L_m	$I_x \text{ cm}^4$	$I_y \text{ cm}^4$
0M0.1505.XX			4.00	4.0	6.00	0.140	0.015

			$\frac{A}{dm^2/m}$	$\frac{P}{dm^2/m}$	L_m	$I_x \text{ cm}^4$	$I_y \text{ cm}^4$
030.3099.XX			31.23	15.3	7.00	9.625	5.654

STEUNPROFIEL
PROFILE DE SUPPORT
SUPPORTING PROFILE
STUETZPROFIL

			$\frac{A}{dm^2/m}$	$\frac{P}{dm^2/m}$	L_m	$I_x \text{ cm}^4$	$I_y \text{ cm}^4$
006.0335.00			12.56	-	7.00	0.819	0.317

KOPPELPROFIEL
PROFILE DE RACCORDEMENT
CONNECTION PROFILE
KUPPLUNGSPROFIL

			$\frac{A}{dm^2/m}$	$\frac{P}{dm^2/m}$	L_m	$I_x \text{ cm}^4$	$I_y \text{ cm}^4$
006.0371.XX			36.54	23.6	7.00	120.097	4.145

VERSTEVIIGINGSPROFIEL
PROFILE DE RENFORCEMENT
REINFORCEMENT PROFILE
VERSTAERKUNGSPROFIL

			$\frac{A}{dm^2/m}$	$\frac{P}{dm^2/m}$	L_m	$I_x \text{ cm}^4$	$I_y \text{ cm}^4$
006.1343.00			33.08	-	6.00	23.403	19.634

			$\frac{A}{dm^2/m}$	$\frac{P}{dm^2/m}$	L_m	$I_x \text{ cm}^4$	$I_y \text{ cm}^4$
030.0138.00			-	-	7.00	-	-

MIDDENSTIJL 4-SLAG
LIAISON CENTRALE 4 VANTAUX
MEETING STYLE 4 DOORS
STULPPROFIL TUERFLUEGEL 4-SCHLAG

			$\frac{A}{dm^2/m}$	$\frac{P}{dm^2/m}$	L_m	$I_x \text{ cm}^4$	$I_y \text{ cm}^4$
030.1096.00			-	-	7.00	4.881	5.085

			$\frac{A}{dm^2/m}$	$\frac{P}{dm^2/m}$	L_m	$I_x \text{ cm}^4$	$I_y \text{ cm}^4$
006.0345.XX			37.55	8.6	4.00	25.726	2.647

			$\frac{A}{dm^2/m}$	$\frac{P}{dm^2/m}$	L_m	$I_x \text{ cm}^4$	$I_y \text{ cm}^4$
030.1097.00			-	-	7.00	10.260	4.477

			$\frac{A}{dm^2/m}$	$\frac{P}{dm^2/m}$	L_m	$I_x \text{ cm}^4$	$I_y \text{ cm}^4$
030.1098.00			-	-	7.00	19.656	6.287

			$\frac{A}{dm^2/m}$	$\frac{P}{dm^2/m}$	L_m	$I_x \text{ cm}^4$	$I_y \text{ cm}^4$
030.1099.XX			22.25	13.6	7.00	21.049	5.071

			$\frac{A}{dm^2/m}$	$\frac{P}{dm^2/m}$	L_m	$I_x \text{ cm}^4$	$I_y \text{ cm}^4$
030.3097.XX			11.29	11.3	7.00	2.767	5.037

AFWERKINGSPROFIEL
 PROFILE DE FINITION
 FINISHING PROFILE
 AUSFUEHRUNGSPROFIL

			$\frac{A}{dm^2/m}$	$\frac{P}{dm^2/m}$	$\leftarrow L_m \rightarrow$	$I_x \text{ cm}^4$	$I_y \text{ cm}^4$
004.3130.XX			19.05	1.6	6.00	1.141	1.881
006.0370.XX			45.15	5.3	7.00	147.133	5.660
009.1886.XX			18.47	3.1	7.00	0.884	3.914
030.2140.00			24.48	-	7.00	6.246	2.235
030.2141.00			-	-	7.00	5.613	1.162

VLAKKE KLIPS ENKELE BEGLAZING
 CLIP VITRAGE SIMPLE
 CLIP SINGLE GLAZING
 KLEMME EINFACHVERGLASUNG

			$\frac{A}{dm^2/m}$	$\frac{P}{dm^2/m}$	$\leftarrow L_m \rightarrow$	$I_x \text{ cm}^4$	$I_y \text{ cm}^4$
043.1028.XX			9.59	2.3	6.00	-	-

DILATATIEPROFIEL
 PROFILE DE DILATATION
 EXPANSION PROFILE
 AUSDEHNUNGSPROFIL

			$\frac{A}{dm^2/m}$	$\frac{P}{dm^2/m}$	$\leftarrow L_m \rightarrow$	$I_x \text{ cm}^4$	$I_y \text{ cm}^4$
030.0080.XX			18.20	2.9	7.00	0.522	0.979
030.3890.XX			18.33	2.8	7.00	0.682	1.066

ROLLUIKGELEIDER
 GUIDE A VOLET
 SHUTTER GUIDE
 ROLLADENFUEHRUNG

			$\frac{A}{dm^2/m}$	$\frac{P}{dm^2/m}$	$\leftarrow L_m \rightarrow$	$I_x \text{ cm}^4$	$I_y \text{ cm}^4$
030.1142.XX			35.19	7.0	6.00	13.153	3.015
030.1143.XX			22.89	7.8	6.00	2.215	3.495
030.1147.XX			30.35	11.5	6.00	15.647	4.383
004.3167.XX			35.96	23.2	6.00	9.873	3.238
004.3843.XX			23.68	8.0	6.00	4.009	1.621

004.3168.XX			54.76	30.3	6.00	41.102	5.965
-------------	--	--	-------	------	------	--------	-------

AFDEKPROFIEL
 PROFILE DE RECOUVREMENT
 COVERING PROFILE
 ABDECKPROFIL

			$\frac{A}{dm^2/m}$	$\frac{P}{dm^2/m}$	$\leftarrow L_m \rightarrow$	$I_x \text{ cm}^4$	$I_y \text{ cm}^4$
006.0365.XX			26.92	12.4	7.00	4.099	13.144

BEVESTIGINGSPROFIEL REYNACONNECT
SUPPORT DE MONTAGE REYNACONNECT
FIXATION PROFILE REYNACONNECT
BEFESTIGUNGSPROFIL REYNACONNECT

			$\frac{A}{dm^2/m}$	$\frac{P}{dm^2/m}$	$\leftarrow L_m \rightarrow$	$I_x \text{ cm}^4$	$I_y \text{ cm}^4$
030.1135.XX			16.11	1.6	7.00	1.616	0.266

GLASLAT
PARCLOSE
GLAZING BEAD
GLASLEISTE

			$\frac{A}{dm^2/m}$	$\frac{P}{dm^2/m}$	$\leftarrow L_m \rightarrow$	$I_x \text{ cm}^4$	$I_y \text{ cm}^4$
005.0276.XX			16.30	4.3	7.00	1.002	0.817

030.3200.XX			10.77	2.9	7.00	0.273	0.632
-------------	--	--	-------	-----	------	-------	-------

030.3606.XX			12.37	3.4	7.00	0.277	0.919
-------------	--	--	-------	-----	------	-------	-------

030.3607.XX			15.11	3.7	7.00	0.333	0.895
-------------	--	--	-------	-----	------	-------	-------

030.3608.XX			15.10	4.0	7.00	0.431	0.914
-------------	--	--	-------	-----	------	-------	-------

030.3609.XX			15.56	4.3	7.00	0.544	0.967
-------------	--	--	-------	-----	------	-------	-------

030.3610.XX			16.19	4.6	7.00	0.691	1.022
-------------	--	--	-------	-----	------	-------	-------

030.3611.XX			16.93	4.9	7.00	0.875	1.076
-------------	--	--	-------	-----	------	-------	-------

			$\frac{A}{dm^2/m}$	$\frac{P}{dm^2/m}$	$\leftarrow L_m \rightarrow$	$I_x \text{ cm}^4$	$I_y \text{ cm}^4$
030.3612.XX			18.97	5.2	7.00	0.995	1.148

030.3613.XX			19.57	5.5	7.00	1.192	1.184
-------------	--	--	-------	-----	------	-------	-------

030.3614.XX			20.17	5.8	7.00	1.431	1.217
-------------	--	--	-------	-----	------	-------	-------

030.3615.XX			20.86	6.1	7.00	1.750	1.252
-------------	--	--	-------	-----	------	-------	-------

030.3616.XX			21.65	6.4	7.00	2.197	1.313
-------------	--	--	-------	-----	------	-------	-------

030.3617.XX			22.66	6.7	7.00	2.650	1.369
-------------	--	--	-------	-----	------	-------	-------

030.3618.XX			23.46	7.0	7.00	3.139	1.404
-------------	--	--	-------	-----	------	-------	-------

030.3619.XX			23.86	7.3	7.00	3.601	1.429
-------------	--	--	-------	-----	------	-------	-------

GLASLAT SCHROEFBAAR
PARCLOSE A VISSER
SCREWABLE GLAZING BEAD
GLASLEISTE SCHRAUBBAR

			$\frac{A}{dm^2/m}$	$\frac{P}{dm^2/m}$	$\leftarrow L_m \rightarrow$	$I_x \text{ cm}^4$	$I_y \text{ cm}^4$
030.3370.XX			11.80	2.4	7.00	0.253	0.640

BUITENKADER
 DORMANT
 OUTER FRAME
 BLENDRAHMEN

			$\frac{A}{dm^2/m}$	$\frac{P}{dm^2/m}$	L_m	$I_x \text{ cm}^4$	$I_y \text{ cm}^4$
006.0321.XX			65.37	15.5	6.50	300.689	39.630
006.0323.XX			59.76	15.9	7.00	290.407	37.175
006.0325.XX			57.49	24.1	6.50	297.179	61.761
006.0327.XX			57.02	21.5	6.50	254.322	47.496

			$\frac{A}{dm^2/m}$	$\frac{P}{dm^2/m}$	L_m	$I_x \text{ cm}^4$	$I_y \text{ cm}^4$
DILATATIEPROFIEL PROFILE DE DILATATION EXPANSION PROFILE AUSDEHNUNGSPROFIL							
103.0081.04			-	-	7.00	-	-

T-PROFIEL
 TRAVERSE
 TRANSOM-MULLION
 SPROSSE

			$\frac{A}{dm^2/m}$	$\frac{P}{dm^2/m}$	L_m	$I_x \text{ cm}^4$	$I_y \text{ cm}^4$
006.0350.XX			52.95	21.2	7.00	78.450	53.291

AFDEKPROFIEL
 PROFILE DE RECOUVREMENT
 COVERING PROFILE
 ABDECKPROFIL

			$\frac{A}{dm^2/m}$	$\frac{P}{dm^2/m}$	L_m	$I_x \text{ cm}^4$	$I_y \text{ cm}^4$
006.0366.XX			42.21	15.3	7.00	74.403	4.848

WISSELPROFIEL
 CHICANE
 MEETING SECTION
 WECHSELPROFIL

			$\frac{A}{dm^2/m}$	$\frac{P}{dm^2/m}$	L_m	$I_x \text{ cm}^4$	$I_y \text{ cm}^4$
006.0351.XX			32.45	13.2	7.00	50.742	0.663

CP 155-AP CP 155-LS/AP

PROFIELOVERZICHT
APERCU DES PROFILES
PROFILE OVERVIEW
PROFILUEBERSICHT



BUITENKADER ZIJKANT DORMANT COTE LATERAL OUTER FRAME SIDE BLENDRAHMEN SENKRECHT

			$\frac{A}{dm^2/m}$	$\frac{P}{dm^2/m}$	L_m	$I_x \text{ cm}^4$	$I_y \text{ cm}^4$
006.1304.XX			52.41	18.3	6.00	209.341	39.528

			$\frac{A}{dm^2/m}$	$\frac{P}{dm^2/m}$	L_m	$I_x \text{ cm}^4$	$I_y \text{ cm}^4$
030.3650.XX			10.37	4.6	7.00	0.736	1.297

VLEUGEL INBRAAKWEREND OUVRANT PROTECTION ANTI-VOL VENT BURGLAR PROTECTION FLUEGEL EINBRUCHHEMMEND

			$\frac{A}{dm^2/m}$	$\frac{P}{dm^2/m}$	L_m	$I_x \text{ cm}^4$	$I_y \text{ cm}^4$
006.2344.XX			53.94	19.1	4.80	39.341	40.219

GLASLAT INBRAAKWEREND PARCLOSE PROTECTION ANTI-VOL GLAZING BEAD BURGLAR PROTECTION GLASLEISTE EINBRUCHHEMMEND

			$\frac{A}{dm^2/m}$	$\frac{P}{dm^2/m}$	L_m	$I_x \text{ cm}^4$	$I_y \text{ cm}^4$
030.3644.XX			10.24	2.8	7.00	0.291	0.560
030.3645.XX			10.80	3.1	7.00	0.293	0.737
030.3646.XX			13.06	3.4	7.00	0.296	0.957
030.3647.XX			9.74	3.7	7.00	0.376	1.072
030.3648.XX			9.83	4.0	7.00	0.447	1.148
030.3649.XX			9.94	4.3	7.00	0.548	1.211

CP 155 CP 155-LS

BUITENKADERS
DORMANTS
OUTER FRAMES
BLENDRAHMEN



	A dm ² /m	P dm ² /m	L_m	I_x cm ⁴	W_x cm ³	ax mm	I_y cm ⁴	W_y cm ³	ay mm	X Y X 0
006.0360.XX	32.02	11.2	7.00	21.640	4.923	43.95	1.875	0.857	21.89	
006.1300.XX	54.70	21.3	7.00/4.80	216.247	27.782	77.84	53.752	16.849	31.10	
006.1301.04	-	-	7.00	-	-	-	-	-	-	
011.4631.--	-	-	7.00	-	-	-	-	-	-	

006.1300.XX

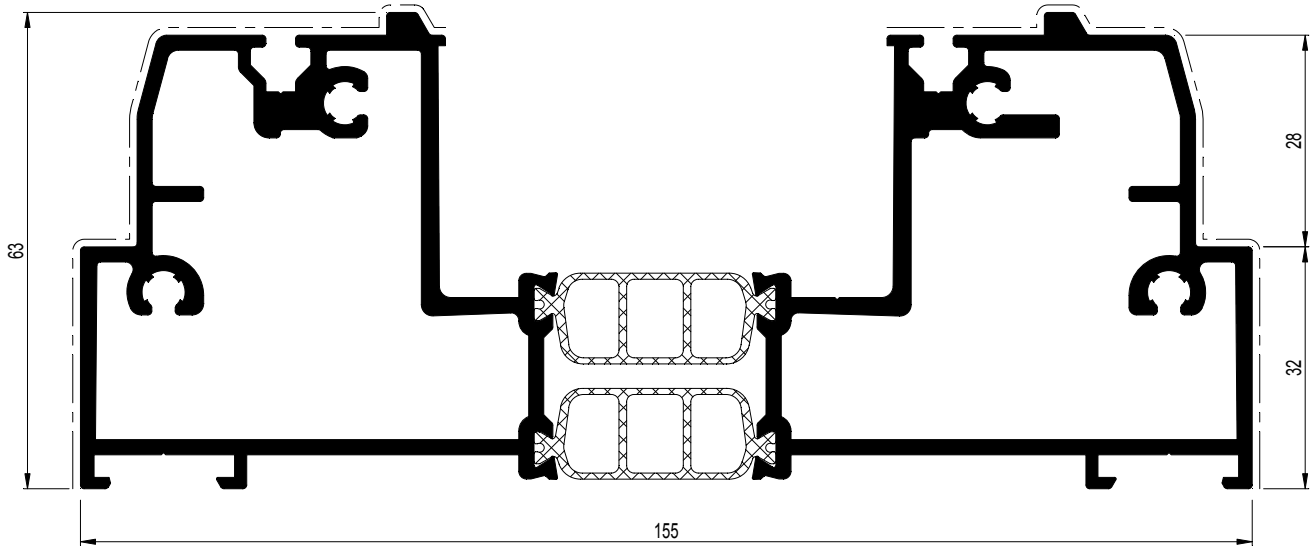

006.1301.04

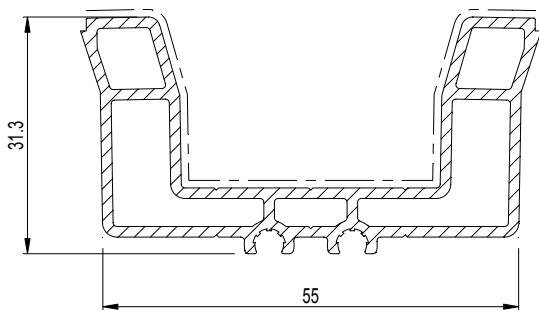

006.0360.XX

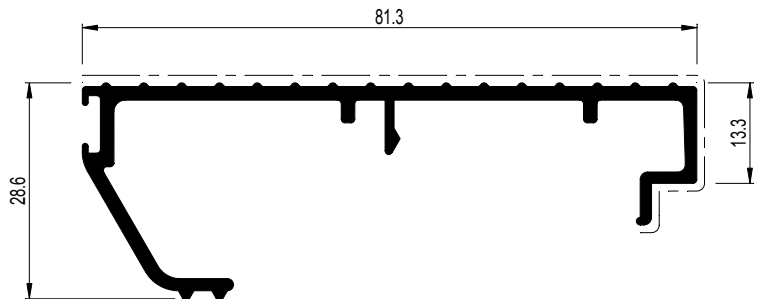

011.4631.--

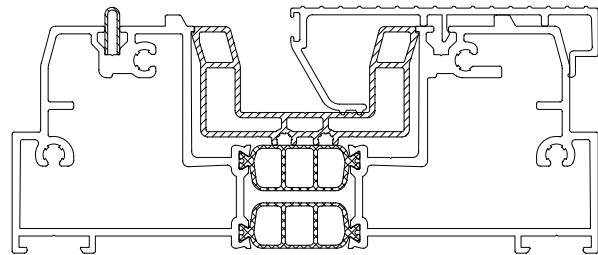
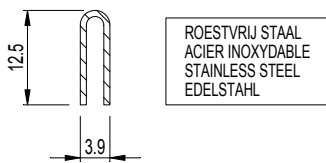

	006.1300.XX	
	068.7555.00 (2x)	095.H800.00 of-ou-or-oder 095.B500.00
	068.8576.00 (2x)	097.0440.00
	052.5371.-- (4x)	097.0014.00

	A dm ² /m	P dm ² /m	L_m	I_x cm ⁴	W_x cm ³	a_x mm	I_y cm ⁴	W_y cm ³	a_y mm	X Y X 0
006.1302.XX	55.33	23.3	7.00/4.80	256.789	33.134	77.50	57.868	15.279	32.12	
006.1303.04	-	-	7.00	-	-	-	-	-	-	

006.1302.XX

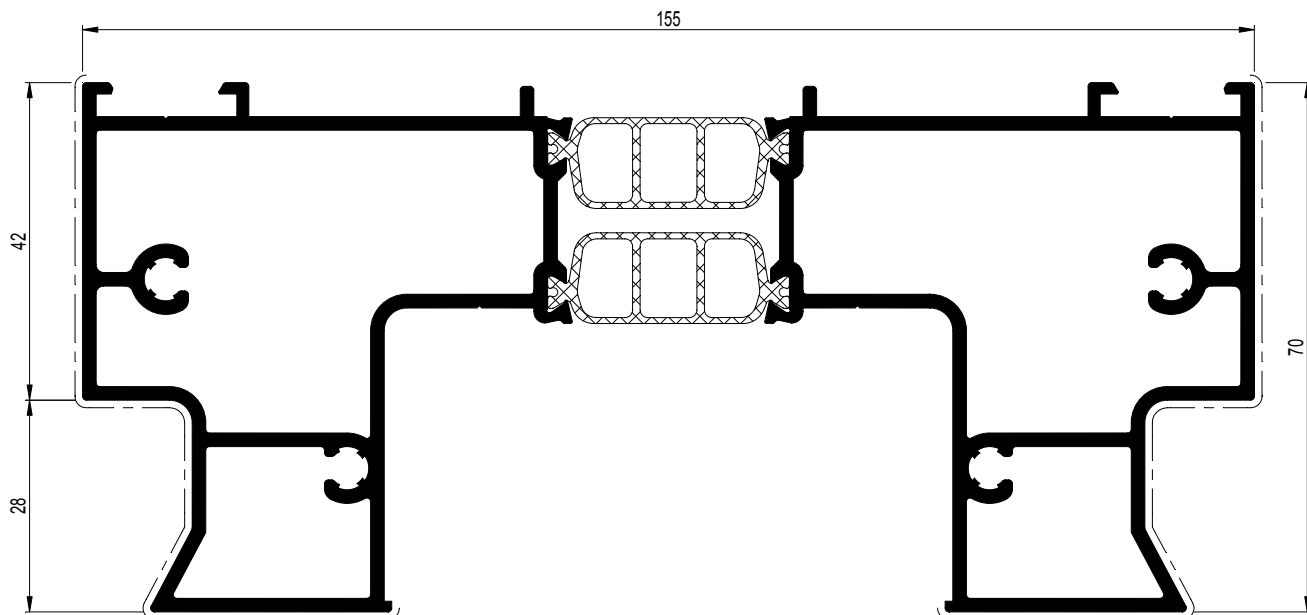

006.1303.04

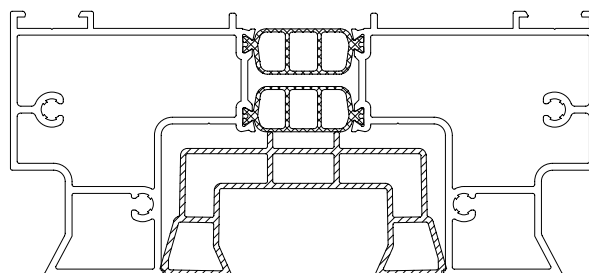
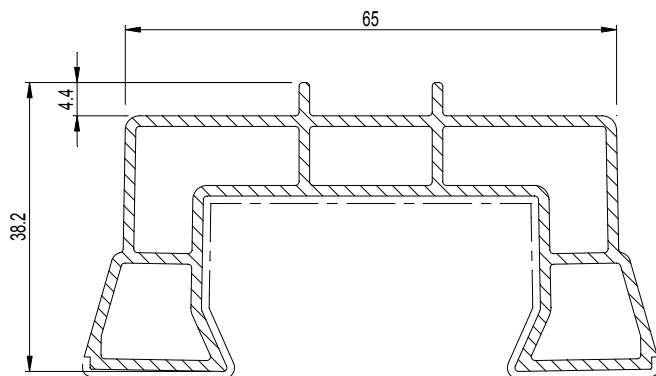

	006.1302.XX	
	052.5371.-- (4x)	097.0014.00

	A dm ² /m	P dm ² /m	L_m	I_x cm ⁴	W_x cm ³	ax mm	I_y cm ⁴	W_y cm ³	ay mm	Y X 0 Y
006.1306.XX	48.97	18.3	6.00	198.518	24.541	80.89	34.118	8.213	26.46	

006.1306.XX

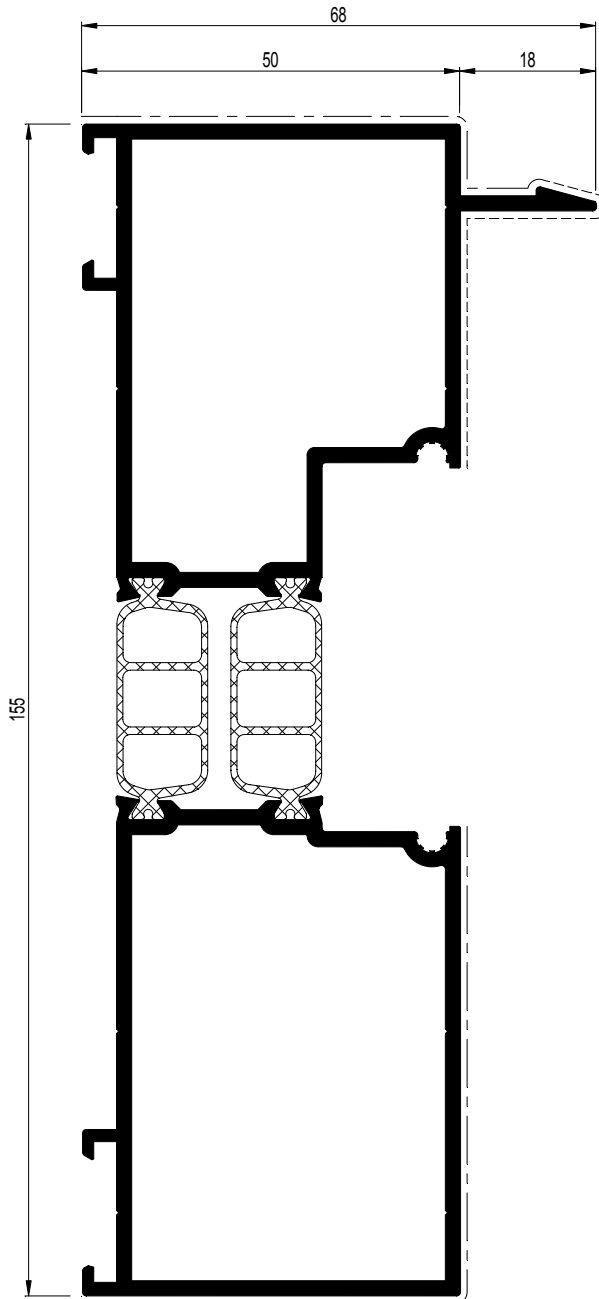

CP 155-LS/AP

BUITENKADER INBRAAKWEREND
 DORMANT PROTECTION ANTI-VOL
 OUTER FRAME BURGLAR PROTECTION
 BLENDRAHMEN EINBRUCHHEMMEND

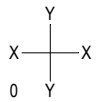

	A dm ² /m	P dm ² /m	L_m	I_x cm ⁴	W_x cm ³	a_x mm	I_y cm ⁴	W_y cm ³	a_y mm	
006.1304.XX	52.41	18.3	6.00	209.341	24.770	84.51	39.528	10.039	28.63	0

006.1304.XX

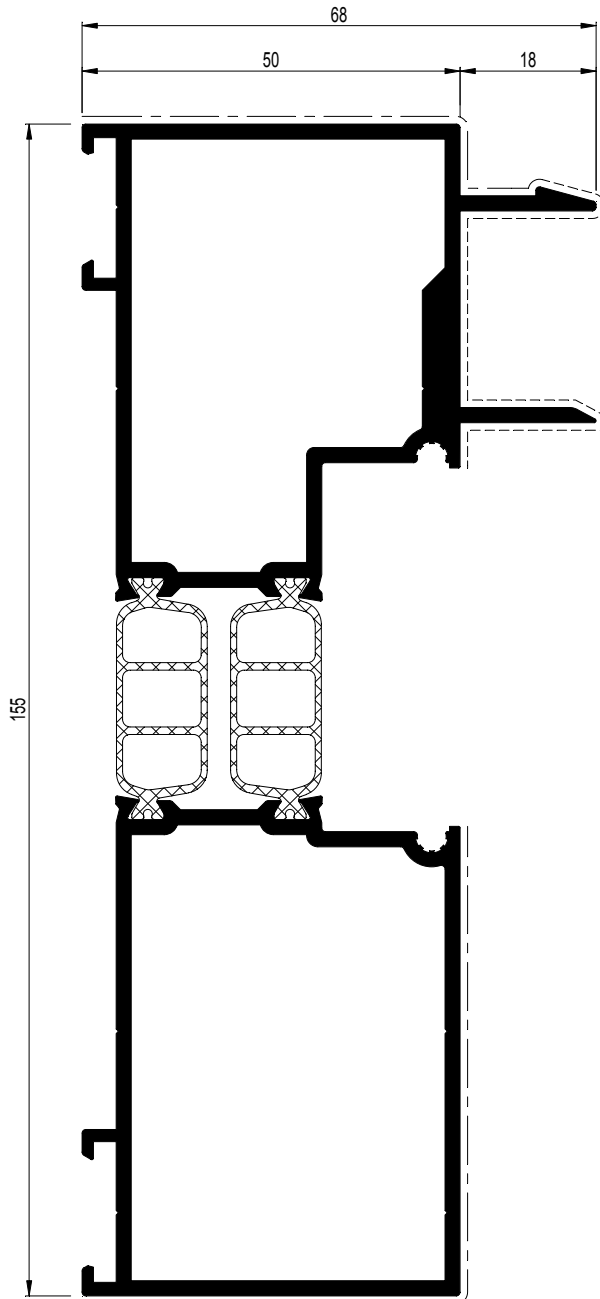

	A dm ² /m	P dm ² /m	L_m	I_x cm ⁴	W_x cm ³	a_x mm	I_y cm ⁴	W_y cm ³	a_y mm	Y X 0 Y
006.0305.04			6.00	-	-	-	-	-	-	

006.0305.04

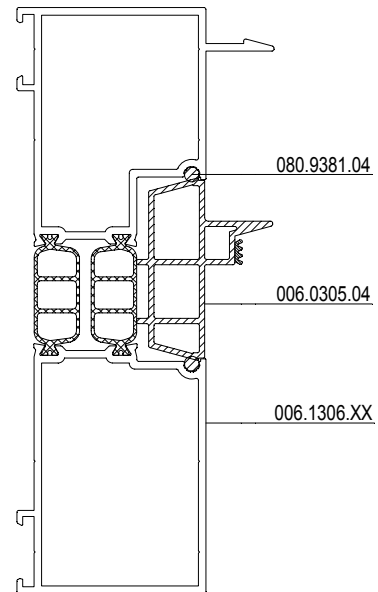
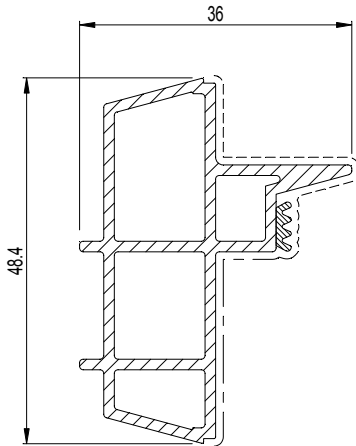

CP 155 CP 155-LS

BUITENKADERS MONORAIL
DORMANTS MONORAIL
OUTER FRAMES MONORAIL
BLENDRAHMEN MONORAIL



	$\frac{A}{dm^2/m}$	$\frac{P}{dm^2/m}$	$\leftarrow L_m \rightarrow$	$I_x \text{ cm}^4$	$W_x \text{ cm}^3$	ax mm	$I_y \text{ cm}^4$	$W_y \text{ cm}^3$	ay mm	X Y X 0
006.0320.XX	55.13	21.0	7.00	162.919	19.082	69.62	38.929	11.769	26.92	
006.1322.XX	54.27	24.4	7.00	191.947	23.037	71.68	35.798	10.631	26.33	

006.0320.XX

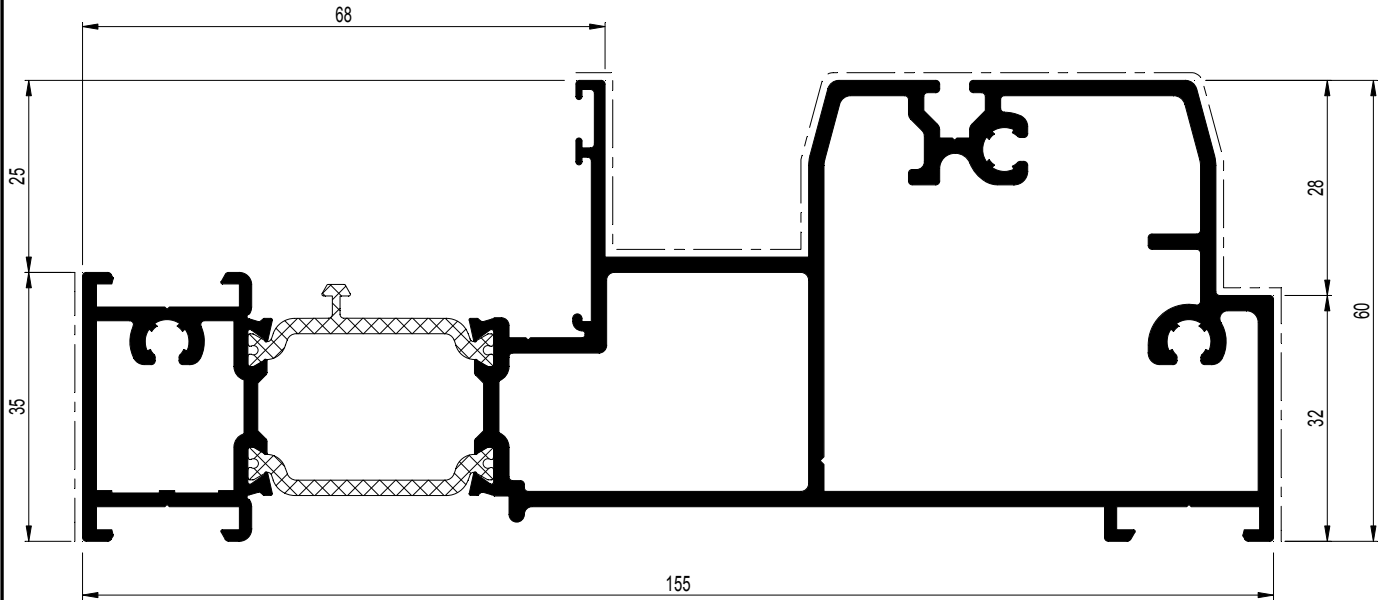

006.1322.XX

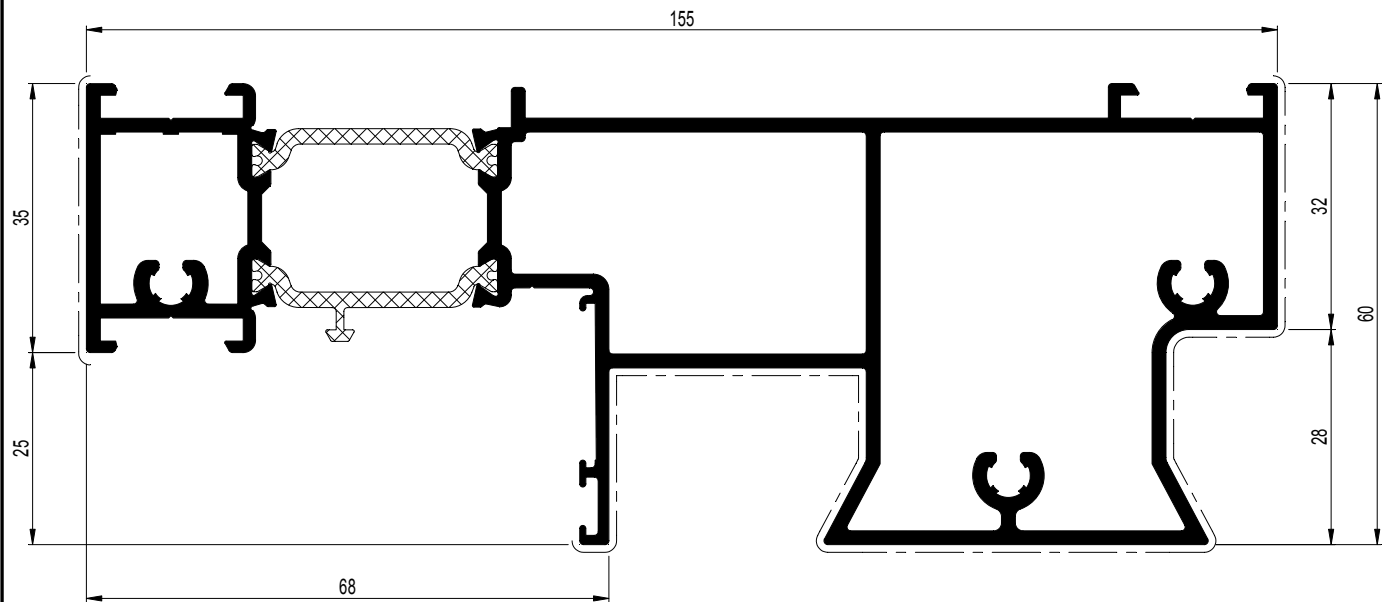

	006.0320.XX	
	068.7558.00	095.H800.00 or 095.B500.00
	068.8574.00	097.0440.00
	052.5371.-- (3x)	097.0014.00
	069.6575.04	---
	060.8723.-- or 060.8746.00	---

	006.1322.XX	
	052.5371.-- (3x)	097.0014.00

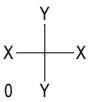
	$\frac{A}{dm^2/m}$	$\frac{P}{dm^2/m}$	L_m	$I_x \text{ cm}^4$	$W_x \text{ cm}^3$	ax mm	$I_y \text{ cm}^4$	$W_y \text{ cm}^3$	ay mm	
006.0324.XX	55.23	25.9	6.50	142.471	18.173	76.60	21.055	5.497	21.70	
006.0326.XX	48.06	18.7	6.50	130.938	16.301	80.33	16.774	4.167	19.75	

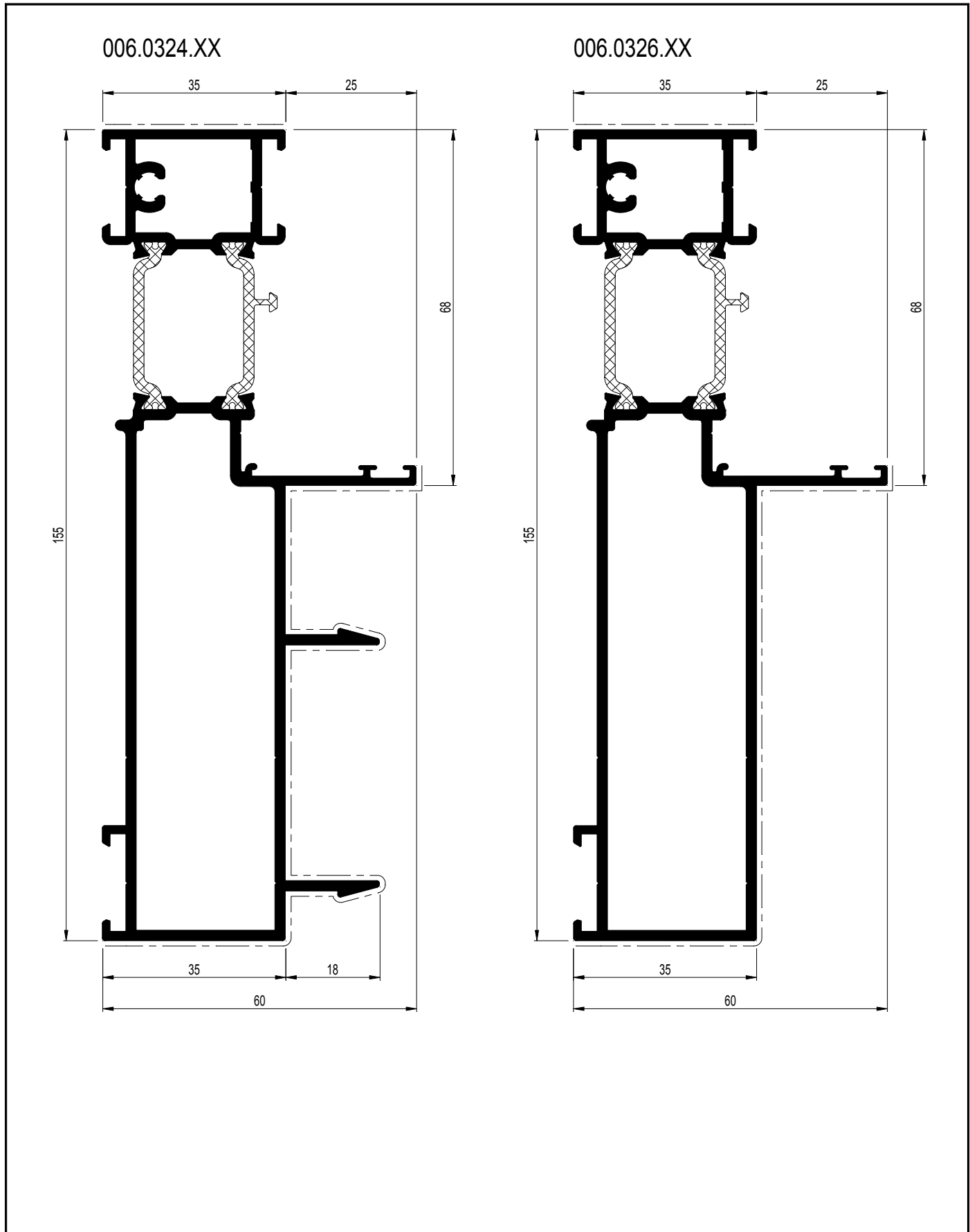

CP 155 CP 155-LS

AFDEKPROFIEL BUITENKADER MONORAIL
 PROFILE DE RECOUVREMENT DORMANT MONORAIL
 COVERING PROFILE OUTER FRAME MONORAIL
 ABDECKPROFIL BLENDRAHMEN MONORAIL

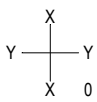

	$\frac{A}{dm^2/m}$	$\frac{P}{dm^2/m}$	$\leftarrow L_m \rightarrow$	$I_x \text{ cm}^4$	$W_x \text{ cm}^3$	ax mm	$I_y \text{ cm}^4$	$W_y \text{ cm}^3$	ay mm	
006.0362.XX	26.70	11.6	7.00	19.939	4.021	49.58	2.111	0.953	22.14	Y X 0
006.0363.XX	26.68	11.5	7.00	17.193	4.165	41.28	1.880	1.215	13.52	

006.0362.XX

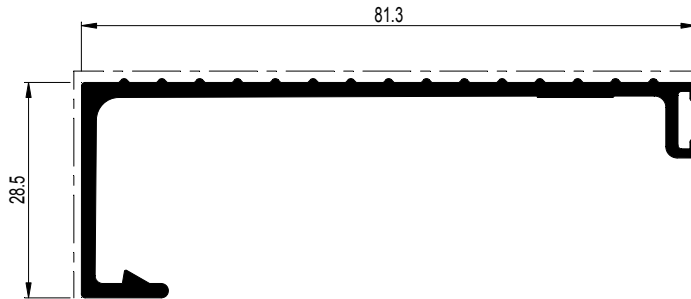

006.0363.XX

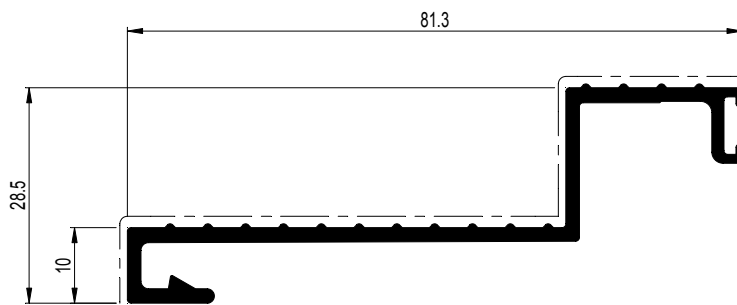

CP 155 CP 155-LS

BUITENKADER 3-RAIL
DORMANT 3-RAIL
OUTER FRAME 3-RAIL
BLENDRAHMEN 3-RAIL



	A dm ² /m	P dm ² /m	L_m	I_x cm ⁴	W_x cm ³	ax mm	I_y cm ⁴	W_y cm ³	ay mm	Y X 0 Y
006.1400.XX	82.08	24.4	7.00	900.669	74.256	121.29	78.297	24.022	30.41	

006.1400.XX

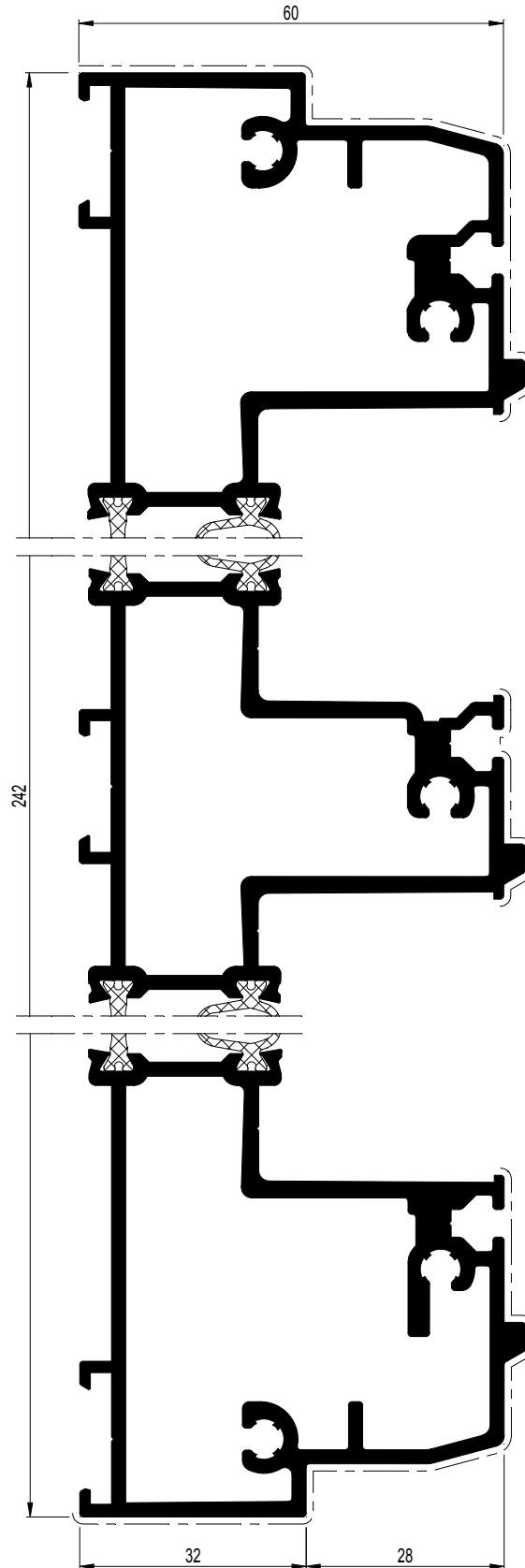

	006.1400.XX	
	068.7555.00 (2x)	095.H800.00
	068.8576.00 (2x)	---
	052.5371.-- (5x)	097.0698.00

	A dm ² /m	P dm ² /m	L_m	I_x cm ⁴	W_x cm ³	a_x mm	I_y cm ⁴	W_y cm ³	a_y mm	Y X 0 Y
006.1402.XX	85.04	24.7	7.00	829.127	68.509	121.03	79.003	20.147	39.21	

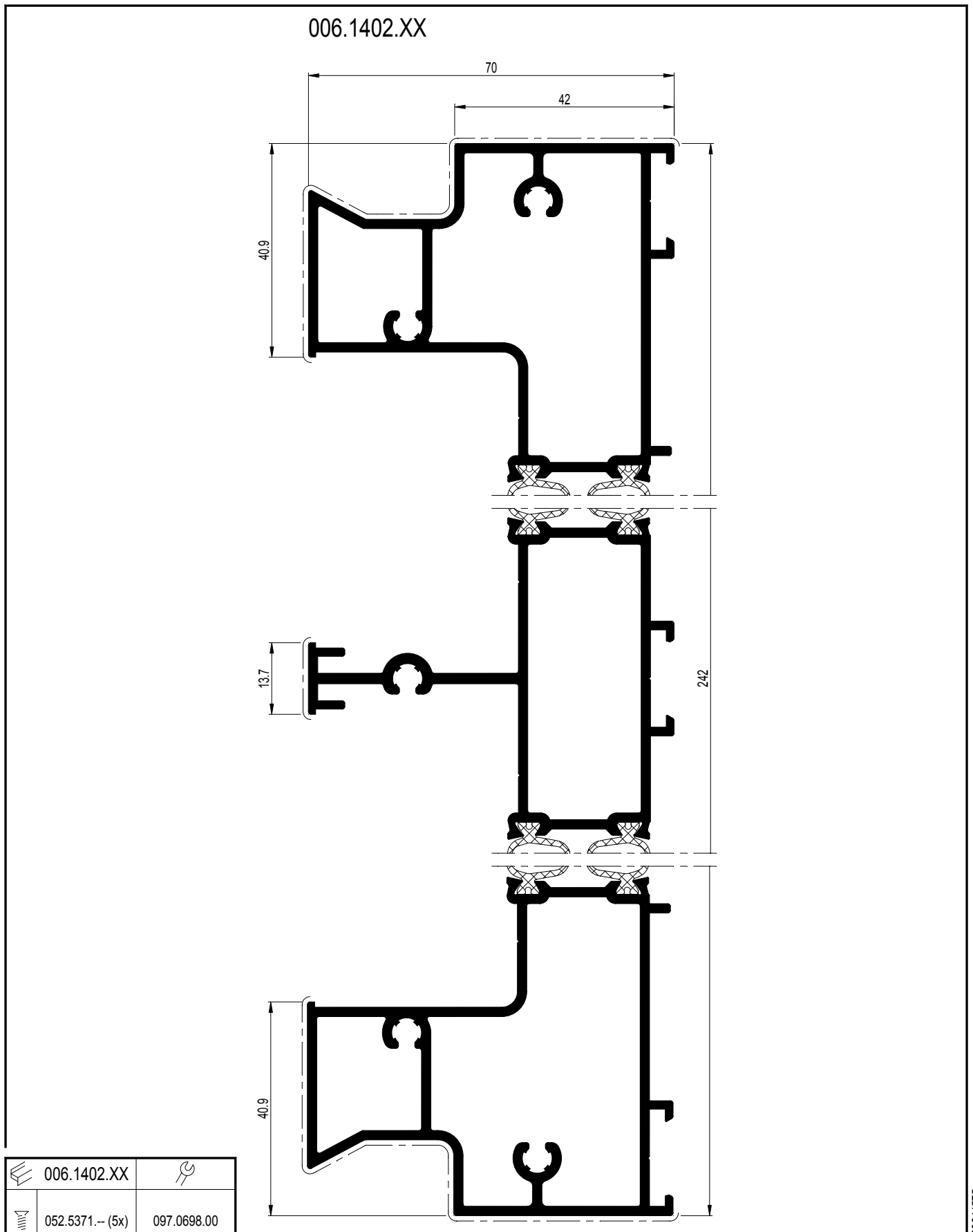

	A dm ² /m	P dm ² /m	L_m	I_x cm ⁴	W_x cm ³	ax mm	I_y cm ⁴	W_y cm ³	ay mm	Y X 0 Y
006.1406.XX	69.12	22.3	6.00	642.510	51.420	124.96	47.461	11.225	25.72	

006.1406.XX

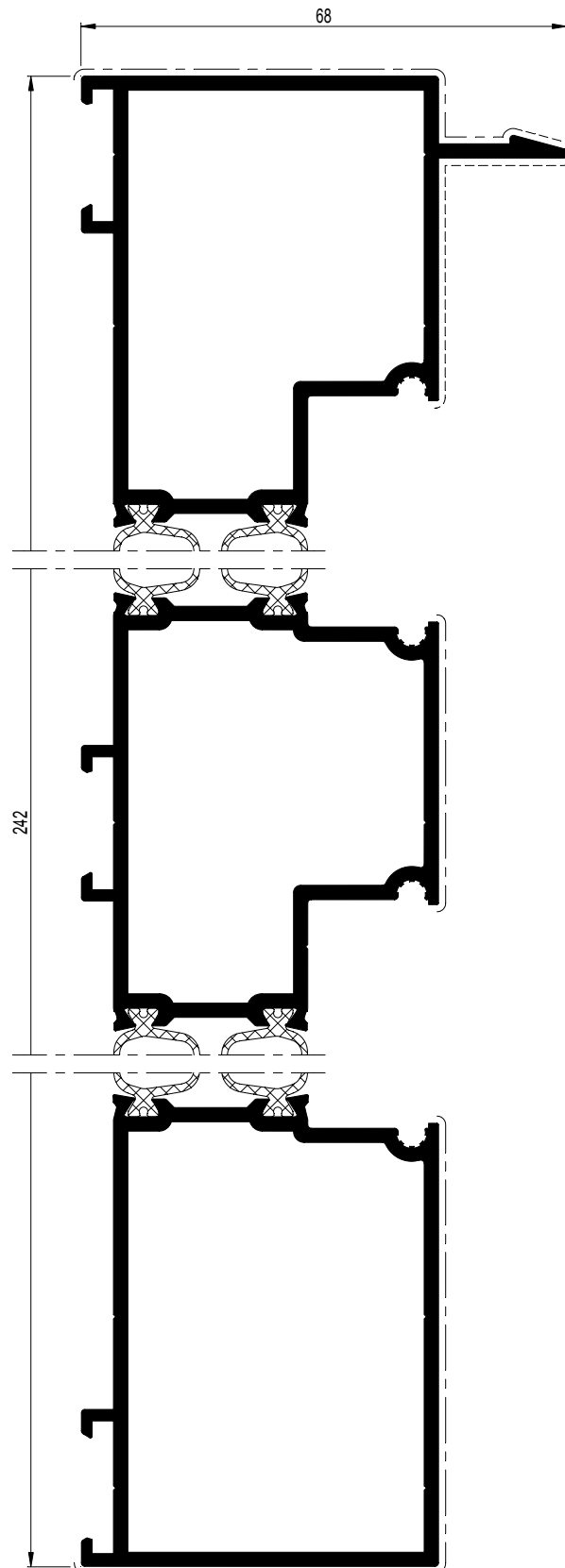

D0044579

CP 155-LS/HI MINERGIE LABEL

BUITENKADER MONORAIL
DORMANT MONORAIL
OUTER FRAME MONORAIL
BLENDRAHMEN MONORAIL



	A dm ² /m	P dm ² /m	L_m	I_x cm ⁴	W_x cm ³	ax mm	I_y cm ⁴	W_y cm ³	ay mm	Y X 0 Y
006.0321.XX	65.37	15.5	6.50	300.689	27.437	109.59	39.630	11.170	27.53	

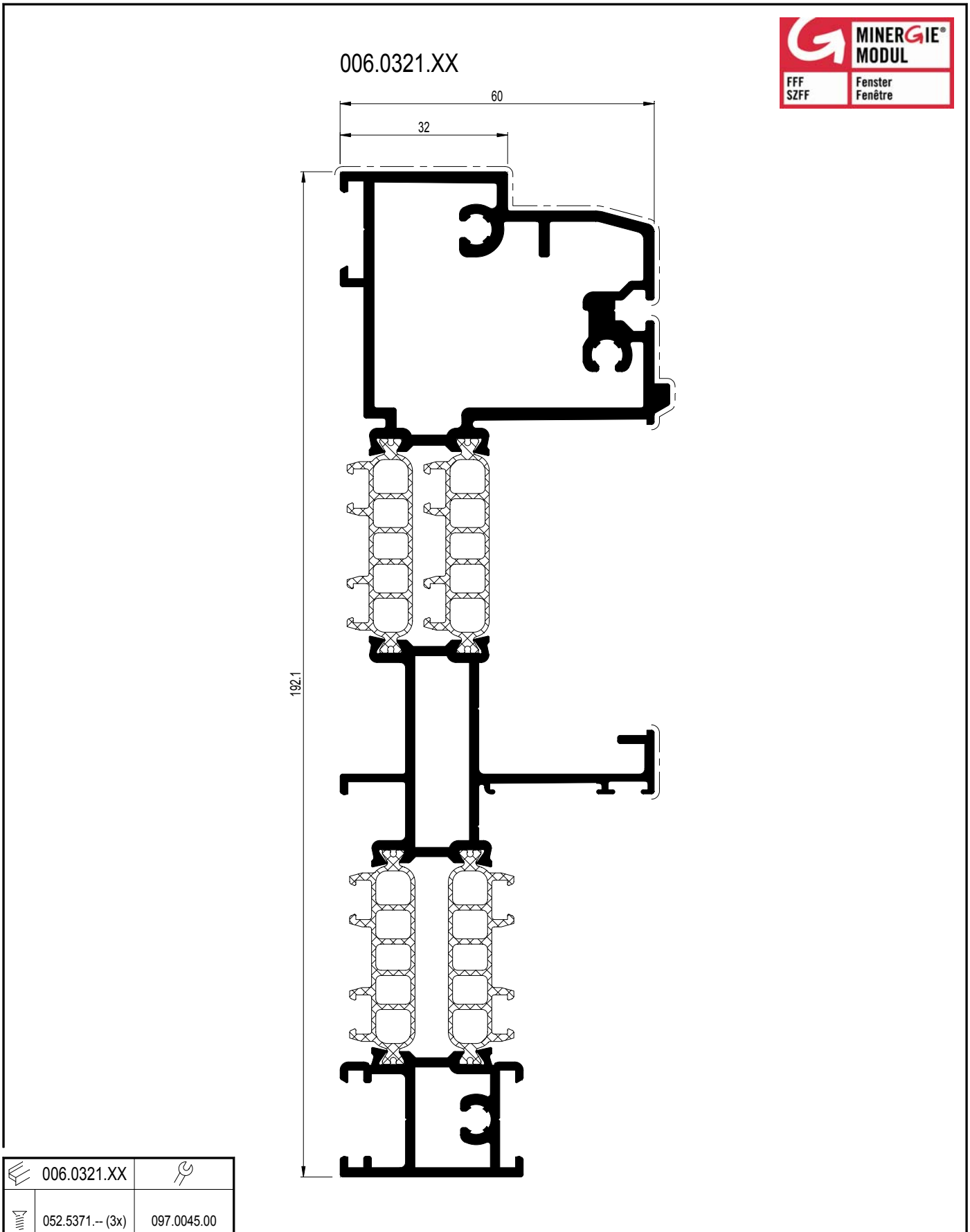

	006.0321.XX	
	052.5371.-- (3x)	097.0045.00

CP 155-LS/HI MINERGIE LABEL

BUITENKADER MONORAIL
DORMANT MONORAIL
OUTER FRAME MONORAIL
BLENDRAHMEN MONORAIL



	A dm ² /m	P dm ² /m	L_m	I_x cm ⁴	W_x cm ³	ax mm	I_y cm ⁴	W_y cm ³	ay mm	Y X 0 Y
006.0323.XX	59.76	15.9	7.00	290.407	27.692	104.87	37.175	9.659	38.49	

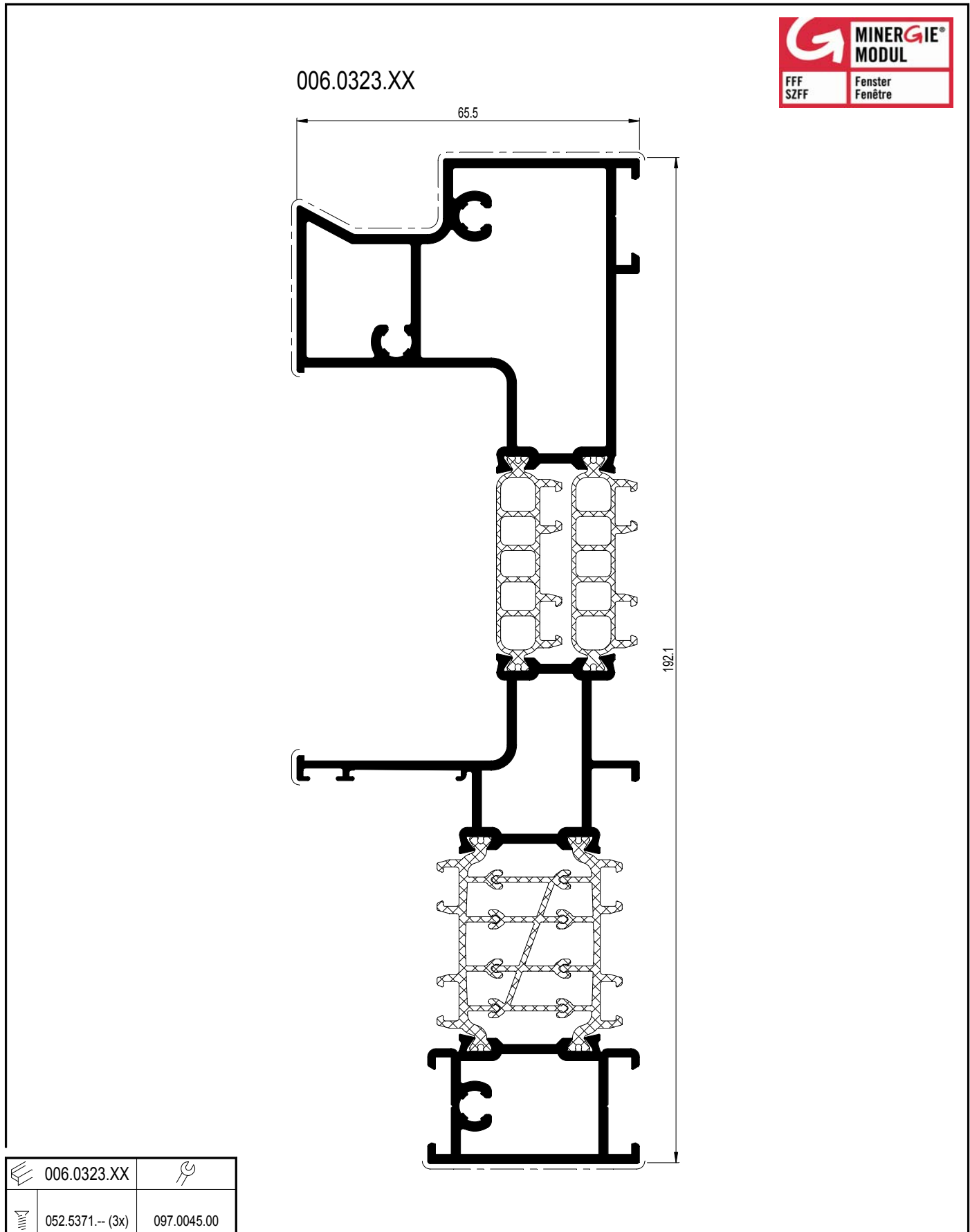

	006.0323.XX	
	052.5371.-- (3x)	097.0045.00

CP 155-LS/Hi MINERGIE LABEL

BUITENKADER MONORAIL
DORMANT MONORAIL
OUTER FRAME MONORAIL
BLENDRAHMEN MONORAIL



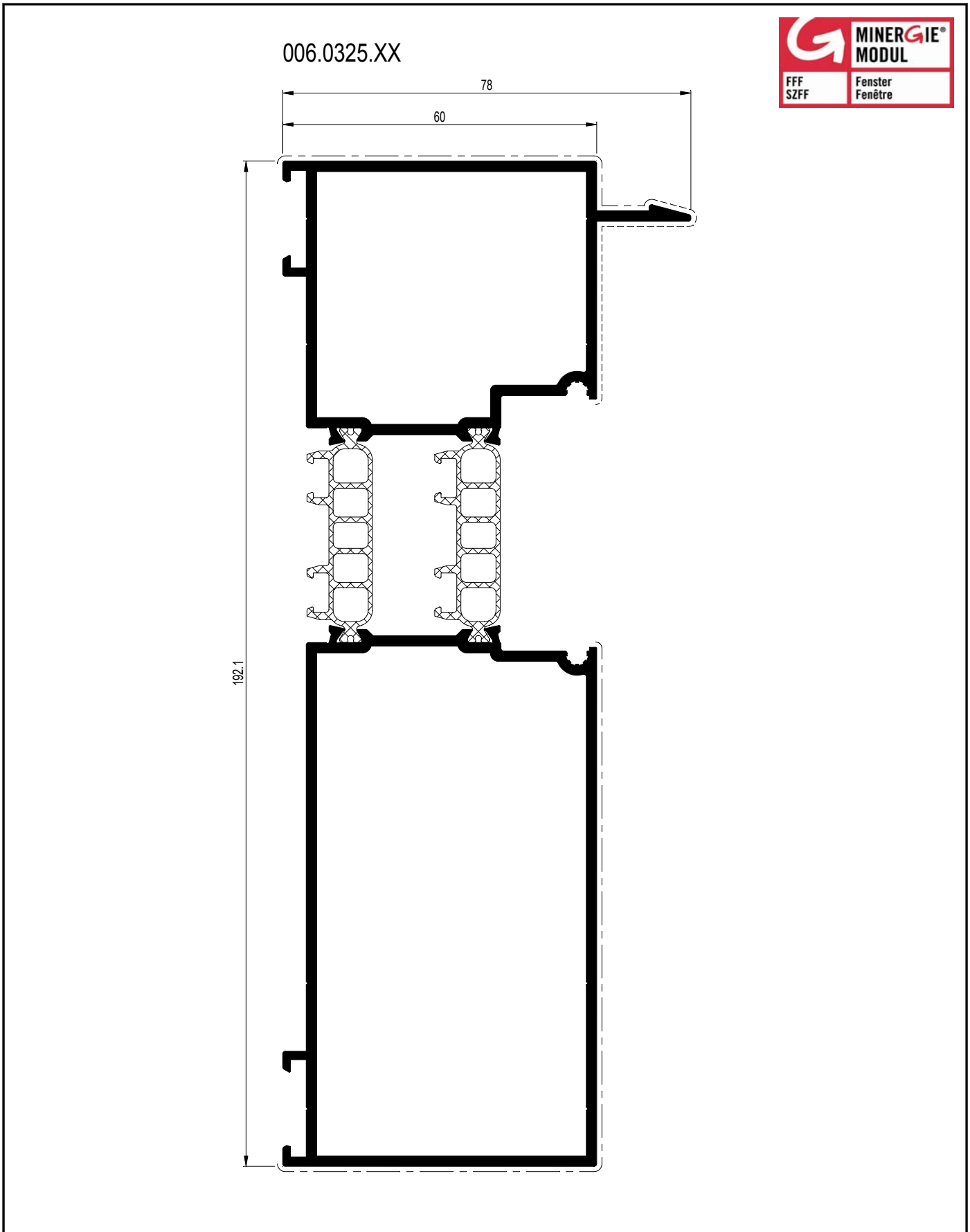

	A dm ² /m	P dm ² /m	L_m	I_x cm ⁴	W_x cm ³	a_x mm	I_y cm ⁴	W_y cm ³	a_y mm	Y X 0 Y
006.0325.XX	57.49	24.1	6.50	297.179	29.425	100.99	61.761	13.417	31.97	



CP 155-LS/HI MINERGIE LABEL

BUITENKADER MONORAIL
DORMANT MONORAIL
OUTER FRAME MONORAIL
BLENDRAHMEN MONORAIL



	A dm ² /m	P dm ² /m	L_m	I_x cm ⁴	W_x cm ³	ax mm	I_y cm ⁴	W_y cm ³	ay mm	
006.0327.XX	57.02	21.5	6.50	254.322	25.737	98.82	47.496	14.395	27.01	

006.0327.XX

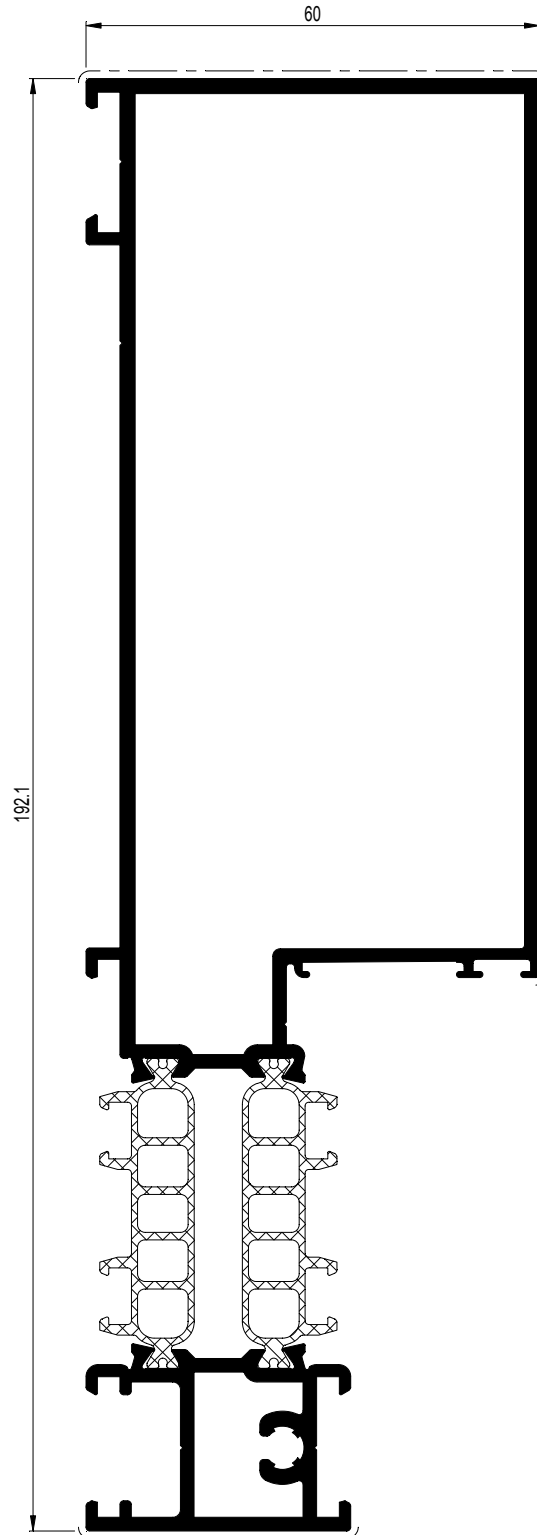

CP 155-LS/Hi MINERGIE LABEL

AFDEKPROFIEL BUITENKADER MONORAIL
 PROFILE DE RECOUVREMENT DORMANT MONORAIL
 COVERING PROFILE OUTER FRAME MONORAIL
 ABDECKPROFIL BLENDRAHMEN MONORAIL



	$\frac{A}{dm^2/m}$	$\frac{P}{dm^2/m}$	L_m	$I_x \text{ cm}^4$	$W_x \text{ cm}^3$	$a_x \text{ mm}$	$I_y \text{ cm}^4$	$W_y \text{ cm}^3$	$a_y \text{ mm}$	X Y X 0
006.0366.XX	42.21	15.3	7.00	74.403	12.002	56.41	4.848	1.891	25.63	
103.0081.04	-	-	7.00	-	-	-	-	-	-	

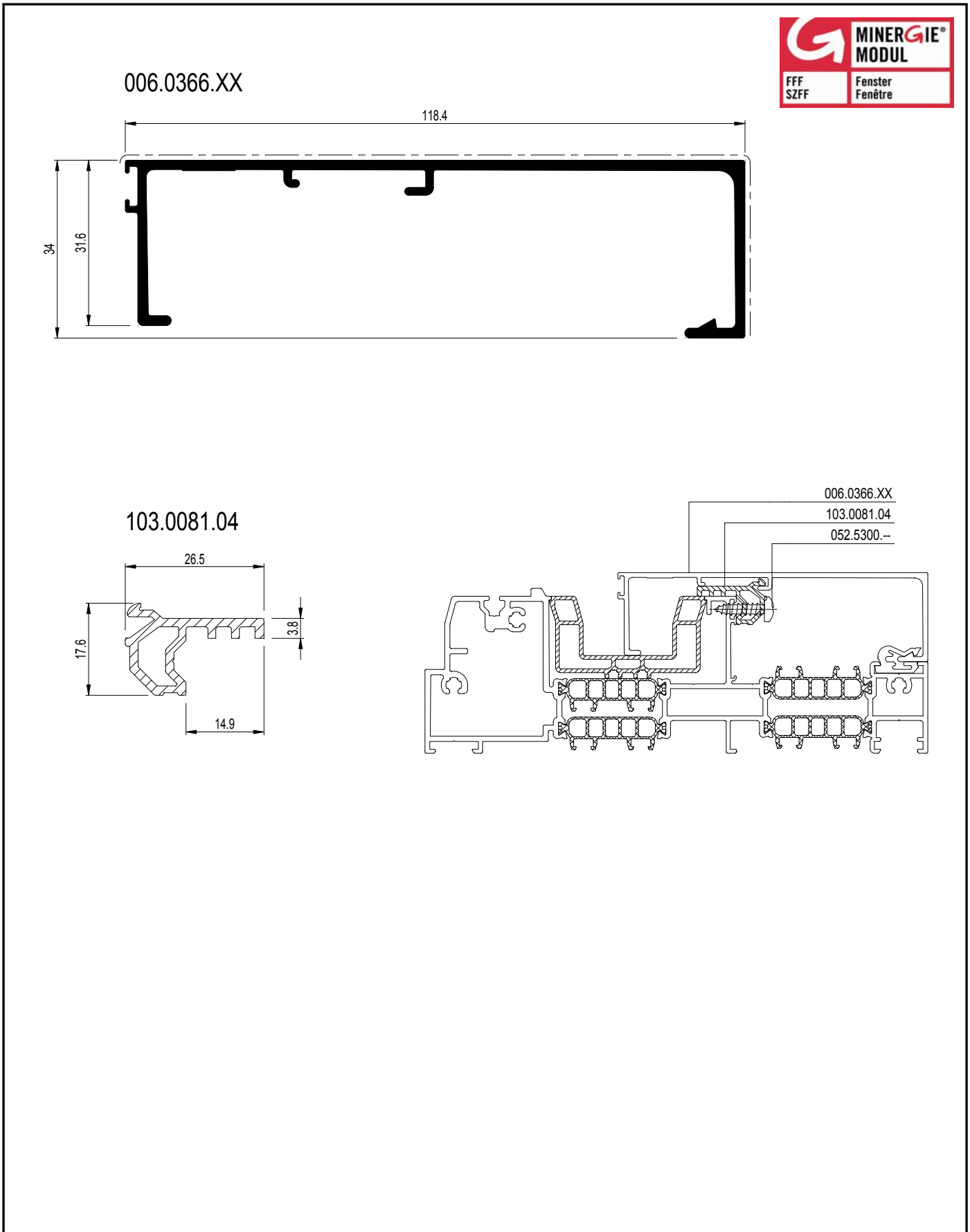

CP 155 CP 155-LS

VLEUGELS
OUVRANTS
VENTS
FLUEGEL



	A dm ² /m	P dm ² /m	L_m	I_x cm ⁴	W_x cm ³	ax mm	I_y cm ⁴	W_y cm ³	ay mm	X Y X 0
006.2340.XX	50.36	19.1	7.00/4.80	39.302	11.286	33.18	36.652	7.043	49.96	

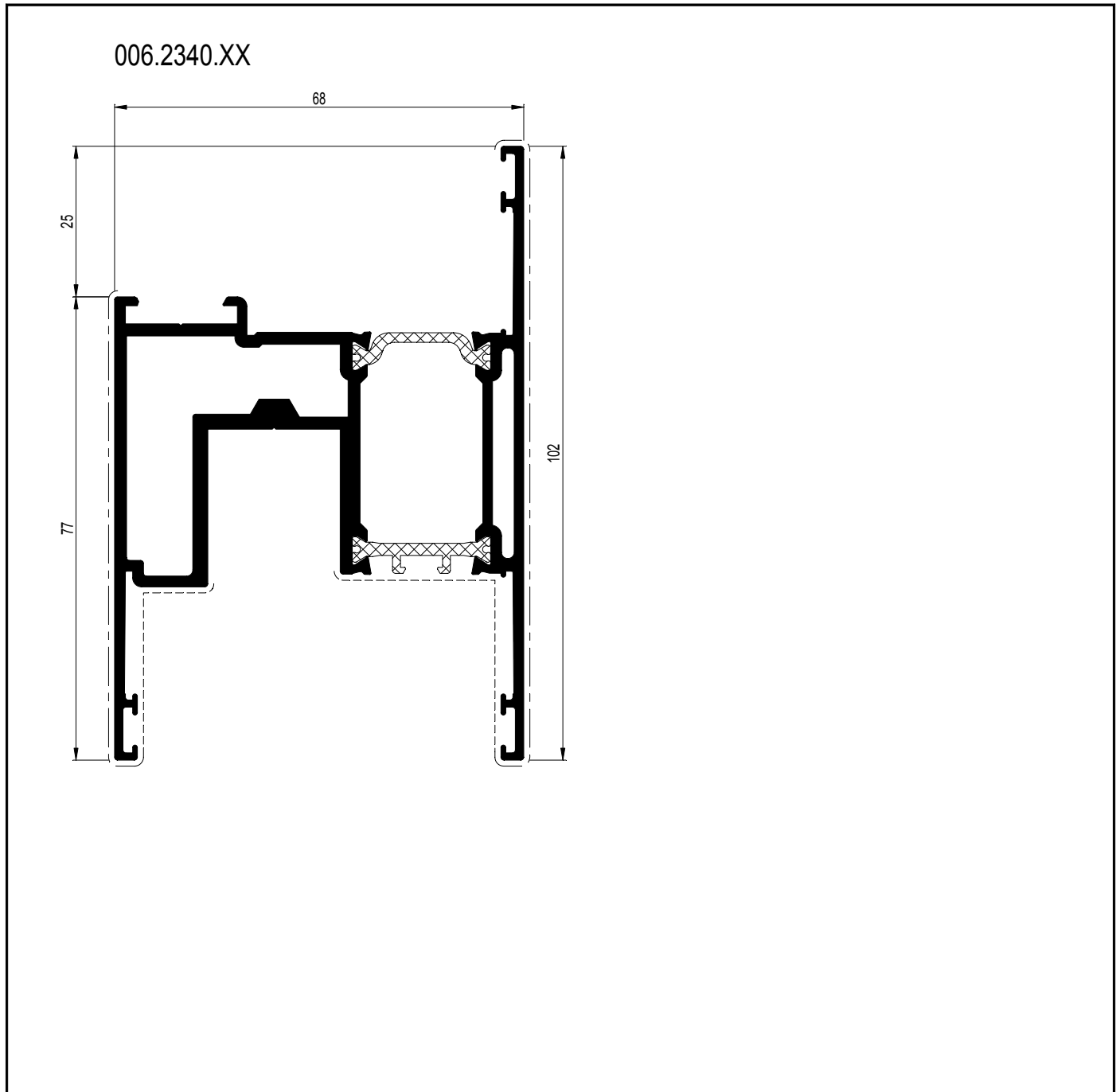

	006.2340.XX	
	068.7775.00	095.H800.00 of-ou-or-oder 095.B500.00
	068.8835.00	097.0441.00
	068.8730.00 (2x)	097.0374.00 of-ou-or-oder 097.0410.00 of-ou-or-oder 097.0463.00
	069.6569.04 068.7776.00	---
	060.8723.-- (2x) + 060.8746.00	---

CP 155-AP CP 155-LS/AP

VLEUGELS INBRAAKWEREND
OUVRANTS PROTECTION ANTI-VOL
VENTS BURGLAR PROTECTION
FLUEGEL EINBRUCHHEMMEND



	A dm ² /m	P dm ² /m	L_m	I_x cm ⁴	W_x cm ³	ax mm	I_y cm ⁴	W_y cm ³	ay mm	X Y X 0
006.2344.XX	53.94	19.1	4.80	39.341	11.241	33.00	40.219	7.522	48.53	

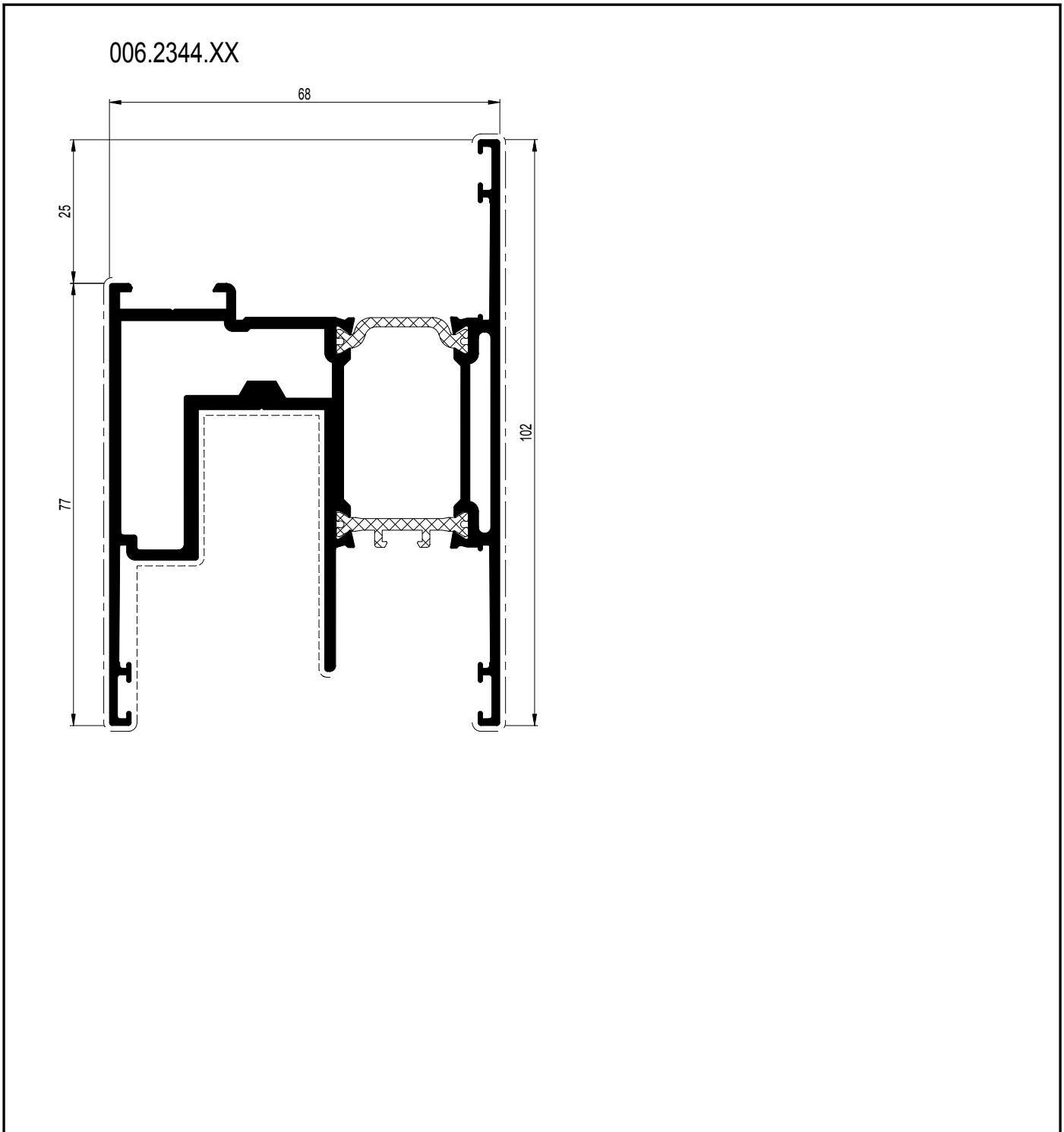

	006.2344.XX	
	068.7775.00	095.H800.00 of-ou-or-oder 095.B500.00
	068.8835.00	---
	069.6569.04 068.7776.00	---
	060.8723.-- (2x) + 060.8746.00	---

CP 155 CP 155-LS

HULPPROFIELEN VLEUGEL
PROFILES DE RACCORDEMENT OUVRANT
ADDITIONAL PROFILES VENT
ZUSATZPROFILE FLUEGEL



	A dm ² /m	P dm ² /m	L_m	I_x cm ⁴	W_x cm ³	ax mm	I_y cm ⁴	W_y cm ³	ay mm	
006.0335.00	12.56	-	7.00	0.819	0.758	10.80	0.317	0.275	8.47	
006.0345.XX	37.55	8.6	4.00	25.726	5.732	42.12	2.647	1.572	16.84	

006.0345.XX

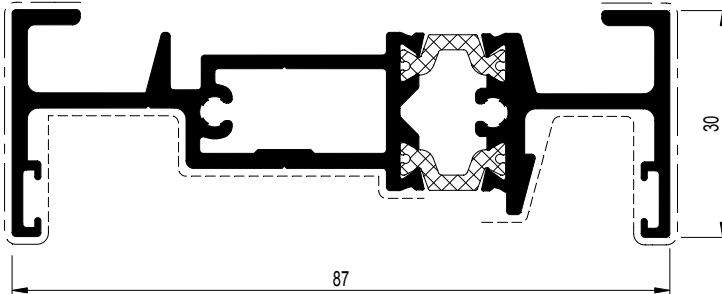

006.0335.00

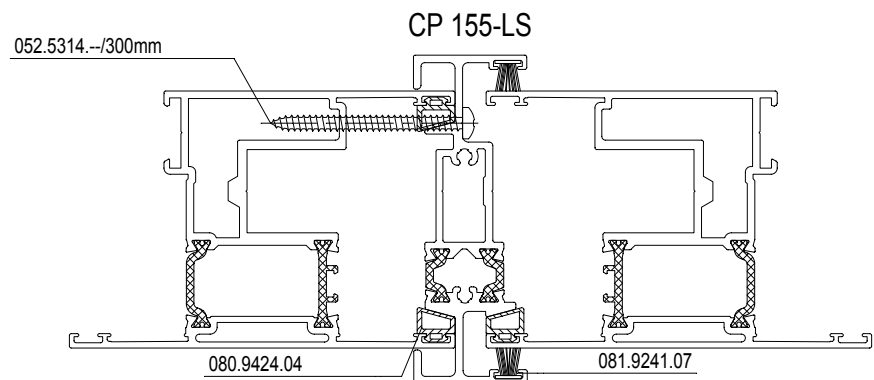
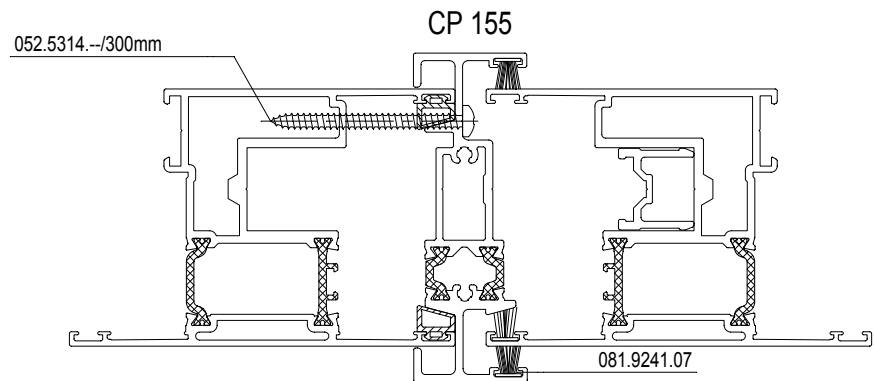
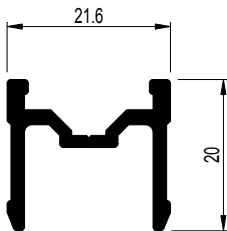

CP 155 CP 155-LS

HULPPROFIELEN VLEUGEL
PROFILES DE RACCORDEMENT OUVRANT
ADDITIONAL PROFILES VENT
ZUSATZPROFILE FLUEGEL



	A dm ² /m	P dm ² /m	Lm	Ix cm ⁴	Wx cm ³	ax mm	Iy cm ⁴	Wy cm ³	ay mm	
006.1341.04	-	-	6.00	1.437	0.633	11.03	6.678	1.913	25.19	
006.1342.XX	25.11	9.7	6.00/3.00	18.817	4.372	38.26	0.568	0.401	3.85	
006.1343.00	33.08	-	6.00	23.403	9.646	24.26	19.634	5.681	27.44	
OM0.1505.XX	4.00	4.0	6.00	0.140	0.187	7.50	0.015	0.062	2.50	

006.1342.XX

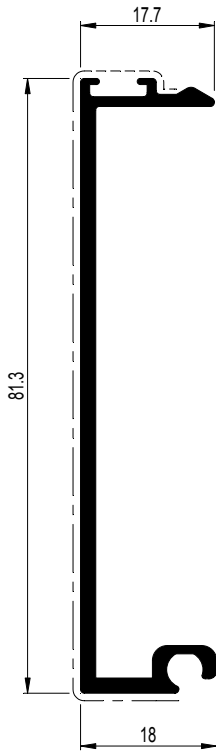

006.1343.00

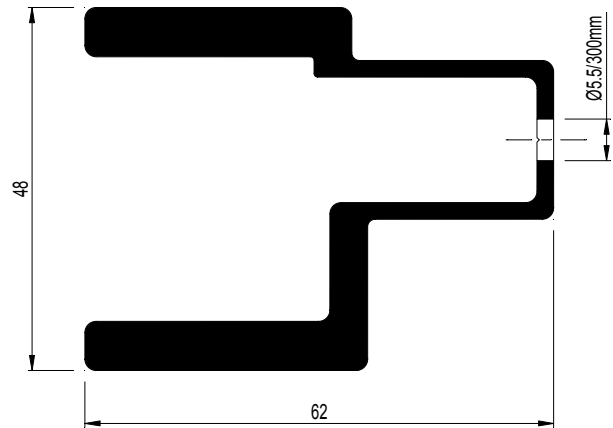

006.1341.04

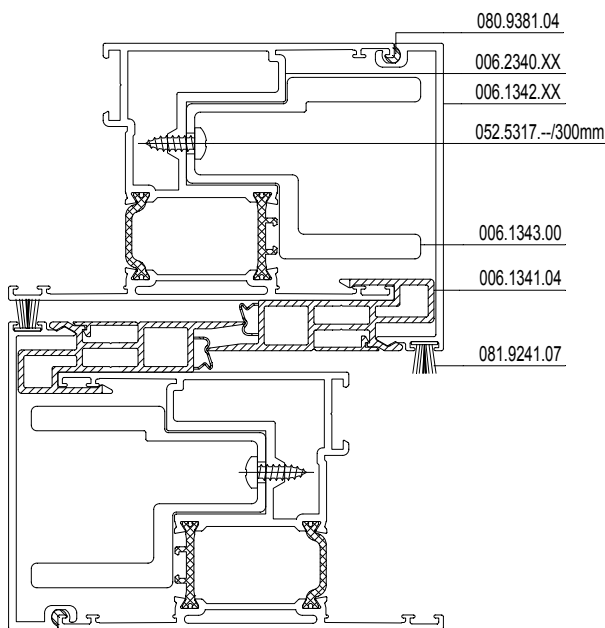
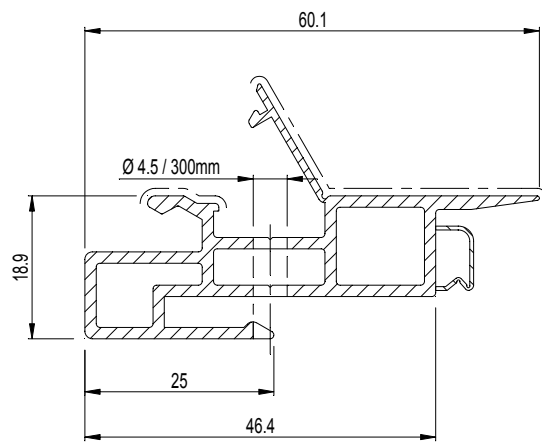

OM0.1505.XX

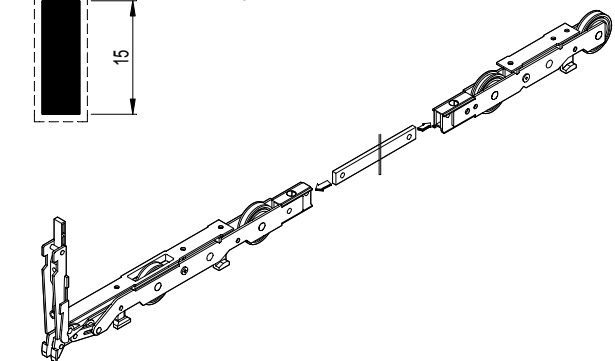
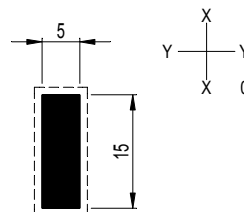

CP 155 CP 155-LS

VERSTERKINGSPROFIELEN VLEUGEL
PROFILES DE RENFORCEMENT OUVRANT
REINFORCEMENT PROFILES VENT
VERSTAERKUNGSPROFIELE FLUEGEL



	A dm ² /m	P dm ² /m	L _m	I _x cm ⁴	W _x cm ³	ax mm	I _y cm ⁴	W _y cm ³	ay mm	
030.1096.00	-	-	7.00	4.881	2.665	18.31	5.085	2.793	18.19	
030.1097.00	-	-	7.00	10.260	3.656	28.06	4.477	2.763	16.20	
030.1098.00	-	-	7.00	19.656	6.418	25.35	6.287	3.880	16.20	
030.3097.XX	11.29	11.3	7.00	2.767	1.132	12.56	5.037	2.583	19.50	
030.3099.XX	31.23	15.3	7.00	9.625	2.614	23.19	5.654	3.220	17.56	

030.3099.XX

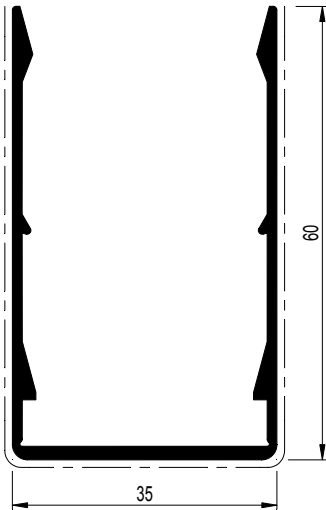

030.1097.00

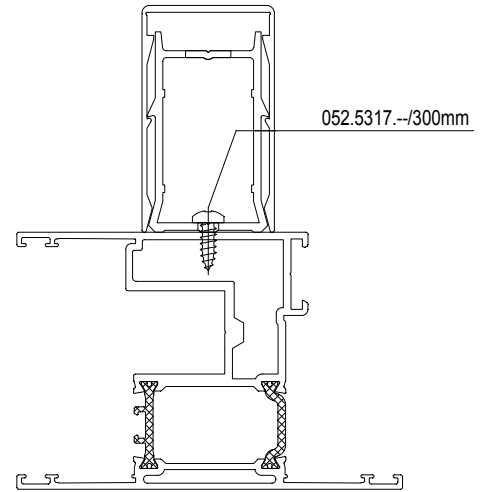
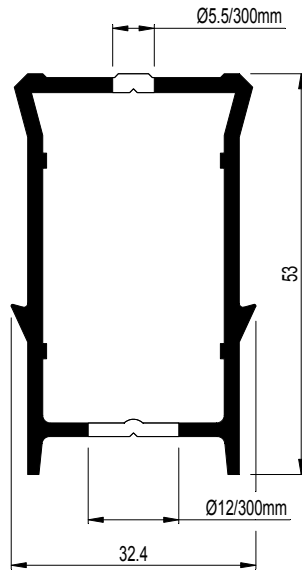

030.3097.XX

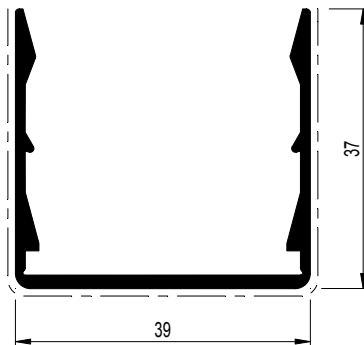

030.1098.00

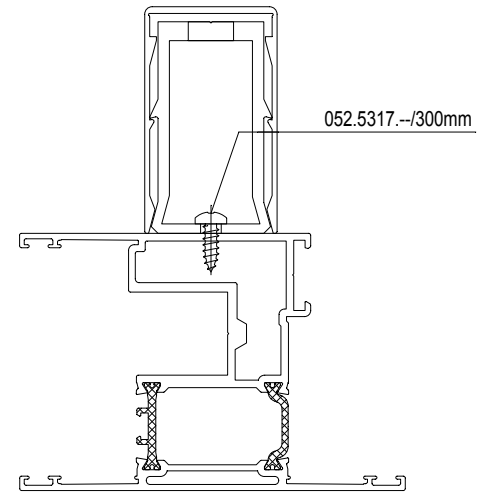
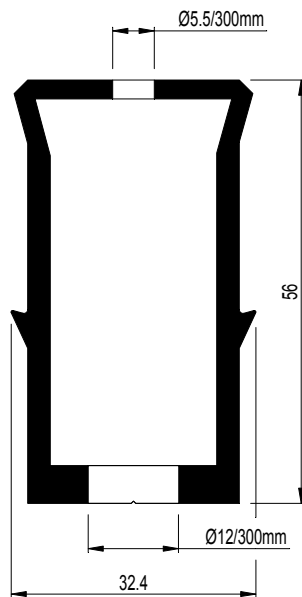

030.1096.00

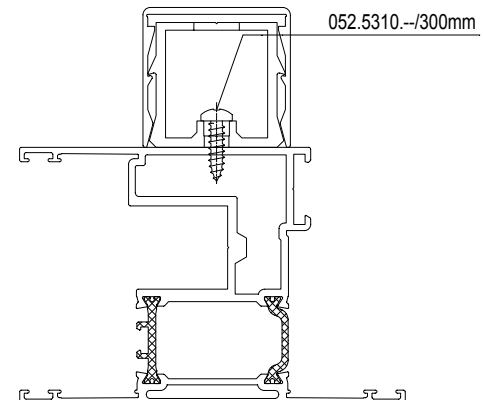
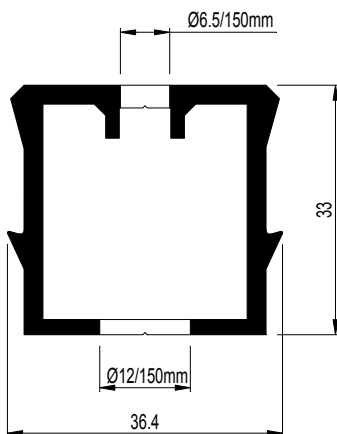

CP 155 CP 155-LS

VERSTEVIGINGSPROFIEL VLEUGEL
 PROFILE DE RENFORCEMENT OUVRANT
 REINFORCEMENT PROFILE VENT
 VERSTAERKUNGSPROFIL FLUEGEL

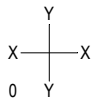

	$\frac{A}{dm^2/m}$	$\frac{P}{dm^2/m}$	$\leftarrow L_m \rightarrow$	$I_x \text{ cm}^4$	$W_x \text{ cm}^3$	ax mm	$I_y \text{ cm}^4$	$W_y \text{ cm}^3$	ay mm	
030.1099.XX	22.25	13.6	7.00	21.049	6.145	34.25	5.071	1.930	26.27	

030.1099.XX

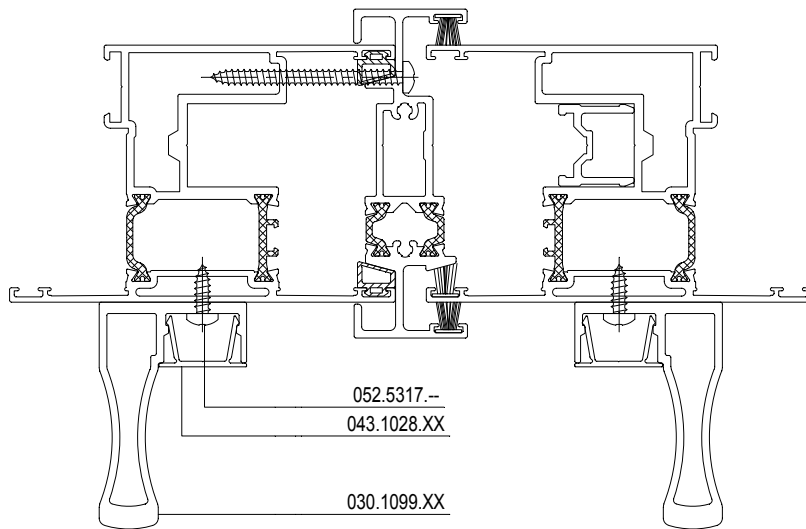
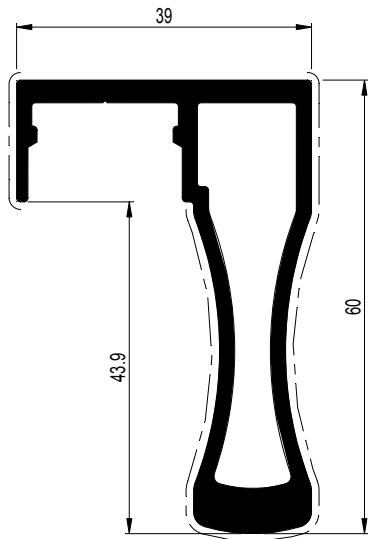

	A dm ² /m	P dm ² /m	L_m	I_x cm ⁴	W_x cm ³	ax mm	I_y cm ⁴	W_y cm ³	ay mm	X Y X 0
008.3113.XX	34.24	11.0	7.00/5.00	16.916	4.166	27.40	8.602	2.264	38.00	
008.3120.XX	38.23	13.6	7.00/5.00	21.513	5.464	28.63	16.299	3.663	44.50	

008.3113.XX

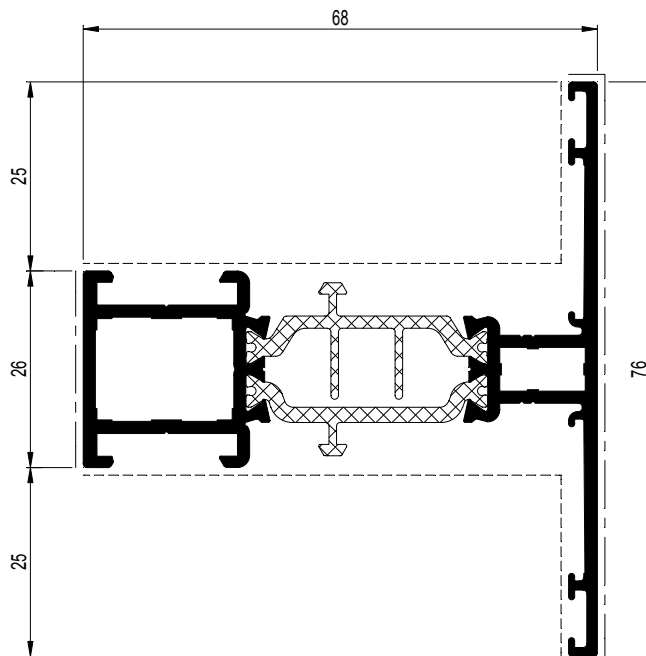

008.3120.XX

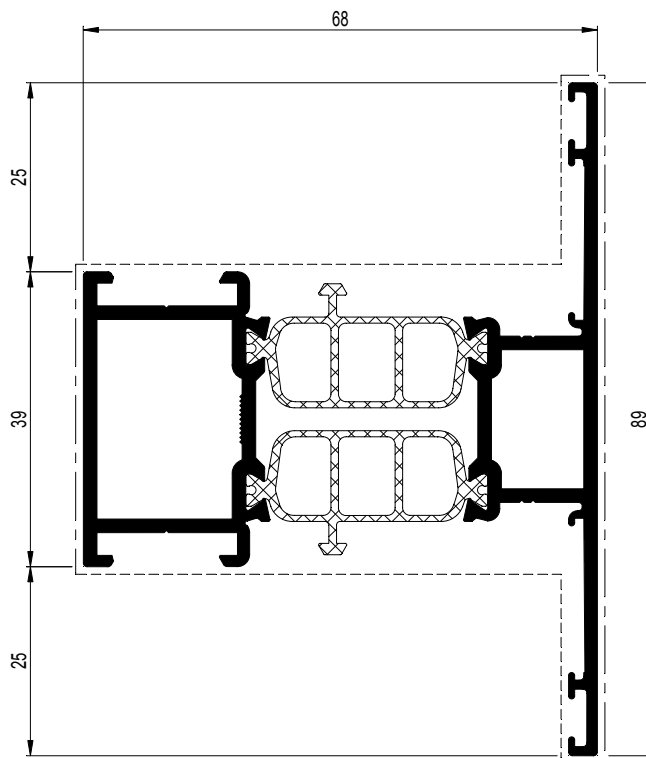

	008.3113.XX	
	068.7850.00 068.7851.00	095.H800.00 of-ou-or-oder 095.B500.00
	068.8840.00	097.O800.00 097.O900.00 097.P000.00 of-ou-or-oder 097.0411.00
	068.7850.00 068.7851.00 050.5153.-- (2x) 068.5938.-- (2x)	097.O800.00 097.O900.00 097.P000.00 of-ou-or-oder 097.0411.00
	068.7850.00 068.7851.00 068.5920.-- (2x) 068.5938.-- (2x)	097.O800.00 097.O900.00 097.P000.00 of-ou-or-oder 097.0411.00
	068.8730.00+(*) or 068.8740.00+(*) (*) 050.5153.--	097.P800.00 097.O900.00 097.P000.00 of-ou-or-oder 097.0410.00
	068.8735.00 050.5153.--	097.P800.00 097.O900.00 097.P000.00 of-ou-or-oder 097.0410.00
	068.8730.00+(*) or 068.8740.00+(*) (*) 068.5920.--	097.P800.00 097.O900.00 097.P000.00 of-ou-or-oder 097.0410.00
	068.8735.00 068.5920.--	097.P800.00 097.O900.00 097.P000.00 of-ou-or-oder 097.0410.00
	068.8779.00 060.8715/16.00 (2x)	097.0009.00
	068.8905.00 060.8715/16.00 (2x)	097.0008.00
	060.8723.-- (2x) or 060.8746.00 (2x) 060.8715/16.00 (2x)	---

	008.3120.XX	
	068.7952.00 068.7853.00	095.H800.00 of-ou-or-oder 095.B500.00
	068.8841.00	097.O800.00 097.P100.00 097.P200.00 of-ou-or-oder 097.0411.00
	068.7952.00 068.7853.00 050.5153.-- (2x) 068.5938.-- (2x)	097.O800.00 097.P100.00 097.P200.00 of-ou-or-oder 097.0411.00
	068.7952.00 068.7853.00 068.5920.-- (2x) 068.5938.-- (2x)	097.O800.00 097.P100.00 097.P200.00 of-ou-or-oder 097.0411.00
	068.8731.00+(*) or 068.8741.00+(*) (*) 050.5153.-- (2x)	097.P800.00 097.P100.00 097.P200.00 of-ou-or-oder 097.0410.00
	068.8736.00 050.5153.-- (2x)	097.P800.00 097.P100.00 097.P200.00 of-ou-or-oder 097.0410.00
	068.8731.00+(*) or 068.8741.00+(*) (*) 068.5920.-- (2x)	097.P800.00 097.P100.00 097.P100.00 of-ou-or-oder 097.0410.00
	068.8736.00 068.5920.-- (2x)	097.P800.00 097.P100.00 097.P200.00 of-ou-or-oder 097.0410.00
	068.8779.00 068.8906.04 060.8715/16.00 (2x)	097.0009.00
	068.8905.00 068.8906.04 (2x) 060.8715/16.00 (2x)	097.0008.00
	060.8723.-- (2x) or 060.8746.00 (2x) 060.8715/16.00 (2x)	---

CP 155 CP 155-LS

T-PROFIELEN
TRAVERSES
TRANSOM-MULLIONS
SPROSSEN



	$\frac{A}{dm^2/m}$	$\frac{P}{dm^2/m}$	$\leftarrow L_m \rightarrow$	$I_x \text{ cm}^4$	$W_x \text{ cm}^3$	ax mm	$I_y \text{ cm}^4$	$W_y \text{ cm}^3$	ay mm	X Y X 0
008.3114.XX	40.81	16.2	7.00/5.00	25.337	6.524	29.16	28.302	5.549	51.00	

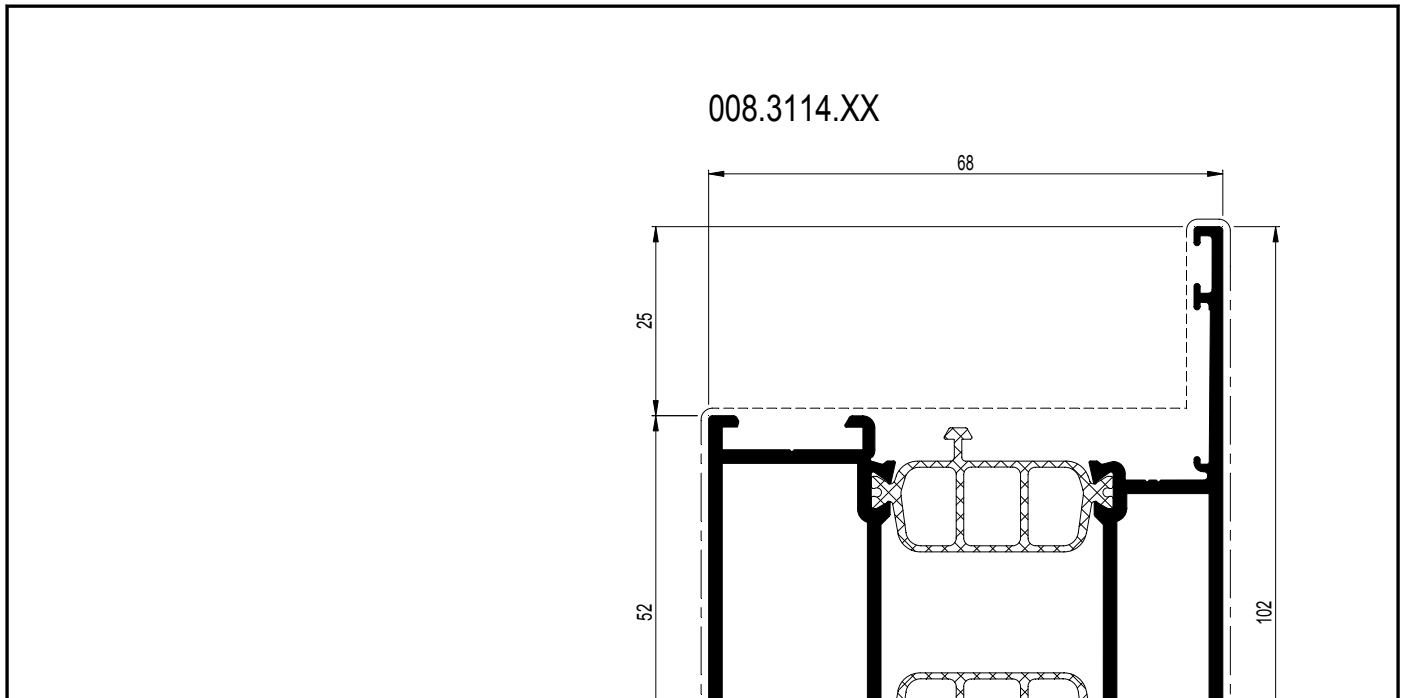

	008.3114.XX	
	068.7854.00 068.7855.00	095.H800.00 of-ou-or-oder 095.B500.00
	068.8842.00	097.O800.00 097.P100.00 097.P200.00 of-ou-or-oder 097.0411.00
	068.7854.00 068.7855.00 050.5153.-- (2x) 068.5938.-- (2x)	097.O800.00 097.P100.00 097.P200.00 of-ou-or-oder 097.0411.00
	068.7854.00 068.7855.00 068.5920.-- (2x) 068.5938.-- (2x)	097.O800.00 097.P100.00 097.P200.00 of-ou-or-oder 097.0411.00
	068.8732.00+(*) or 068.8742.00+(*) (*) 050.5153.-- (2x)	097.P800.00 097.P100.00 097.P200.00 of-ou-or-oder 097.0410.00
	068.8737.00 050.5153.-- (2x)	097.P800.00 097.P100.00 097.P200.00 of-ou-or-oder 097.0410.00
	068.8732.00+(*) or 068.8742.00+(*) (*) 068.5920.-- (2x)	097.P800.00 097.P100.00 097.P200.00 of-ou-or-oder 097.0410.00
	068.8737.00 068.5920.-- (2x)	097.P800.00 097.P100.00 097.P200.00 of-ou-or-oder 097.0410.00
	068.8779.00 068.8906.04 (2x) 060.8715/16.00 (2x)	097.0009.00
	068.8905.00 068.8906.04 (4x) 060.8715/16.00 (2x)	097.0008.00
	060.8723.-- (2x) or 060.8746.00 (2x) 060.8715/16.00 (2x)	---

CP 155 CP 155-LS

T-PROFIELEN
TRAVERSES
TRANSOM-MULLIONS
SPROSSEN



	A dm ² /m	P dm ² /m	L_m	I_x cm ⁴	W_x cm ³	ax mm	I_y cm ⁴	W_y cm ³	ay mm	X Y X 0
008.3123.XX	43.41	18.8	7.00	29.162	7.589	29.57	45.435	7.902	57.50	

008.3123.XX

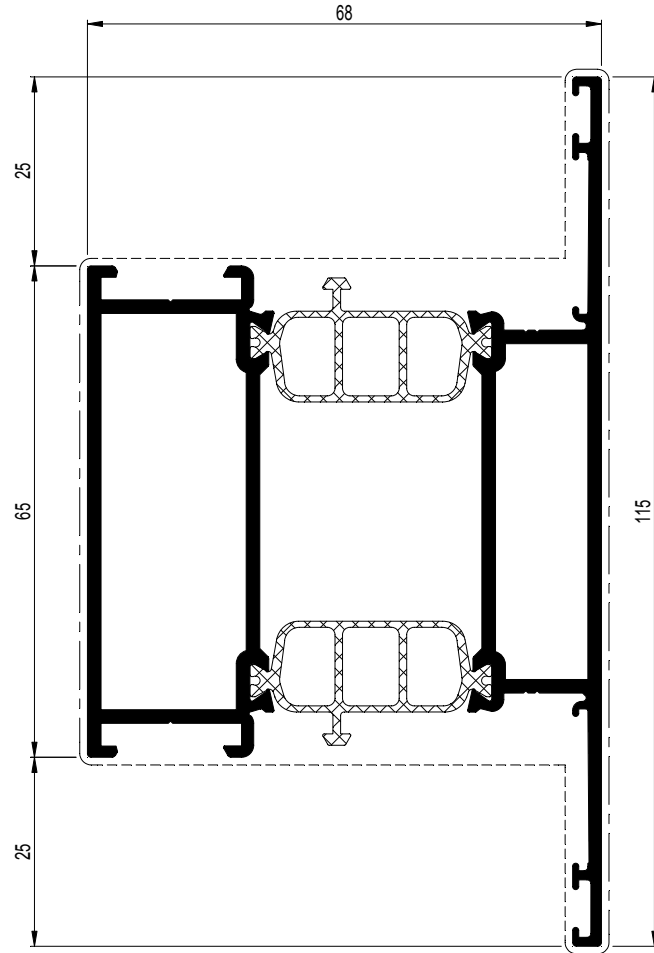

	008.3123.XX	
	068.7856.00 068.7857.00	095.H800.00 of-ou-or-oder 095.B500.00
	068.8843.00	097.O800.00 097.P100.00 097.P200.00 of-ou-or-oder 097.0411.00
	068.7856.00 068.7857.00 050.5153.-- (2x) 068.5938.-- (2x)	097.O800.00 097.P100.00 097.P200.00 of-ou-or-oder 097.0411.00
	068.7856.00 068.7857.00 068.5920.-- (2x) 068.5938.-- (2x)	097.O800.00 097.P100.00 097.P200.00 of-ou-or-oder 097.0411.00
	068.8733.00+ (*) or 068.8743.00+ (*) (*) 050.5153.-- (2x)	097.P800.00 097.P100.00 097.P200.00 of-ou-or-oder 097.0410.00
	068.8738.00 050.5153.-- (2x)	097.P800.00 097.P100.00 097.P200.00 of-ou-or-oder 097.0410.00
	068.8733.00+ (*) or 068.8743.00+ (*) (*) 068.5920.-- (2x)	097.P800.00 097.P100.00 097.P200.00 of-ou-or-oder 097.0410.00
	068.8738.00 068.5920.-- (2x)	097.P800.00 097.P100.00 097.P200.00 of-ou-or-oder 097.0410.00
	068.8779.00 068.8906.04 (3x) 060.8715/16.00 (2x)	097.0009.00
	068.8905.00 068.8906.04 (6x) 060.8715/16.00 (2x)	097.0008.00
	060.8723.-- (2x) or 060.8746.00 (2x) 060.8715/16.00 (2x)	---

CP 155 CP 155-LS

T-PROFIELEN
TRAVERSES
TRANSOM-MULLIONS
SPROSSEN



	A dm ² /m	P dm ² /m	L_m	I_x cm ⁴	W_x cm ³	ax mm	I_y cm ⁴	W_y cm ³	ay mm	X Y 0
008.3824.XX	50.00	26.6	7.00	59.548	16.217	31.28	142.536	18.511	77.00	X
0K8.3824.XX	50.00	26.3	1.15	59.548	16.217	31.28	142.536	18.511	77.00	Y

008.3824.XX L=7.00m

0K8.3824.XX L=1.15m

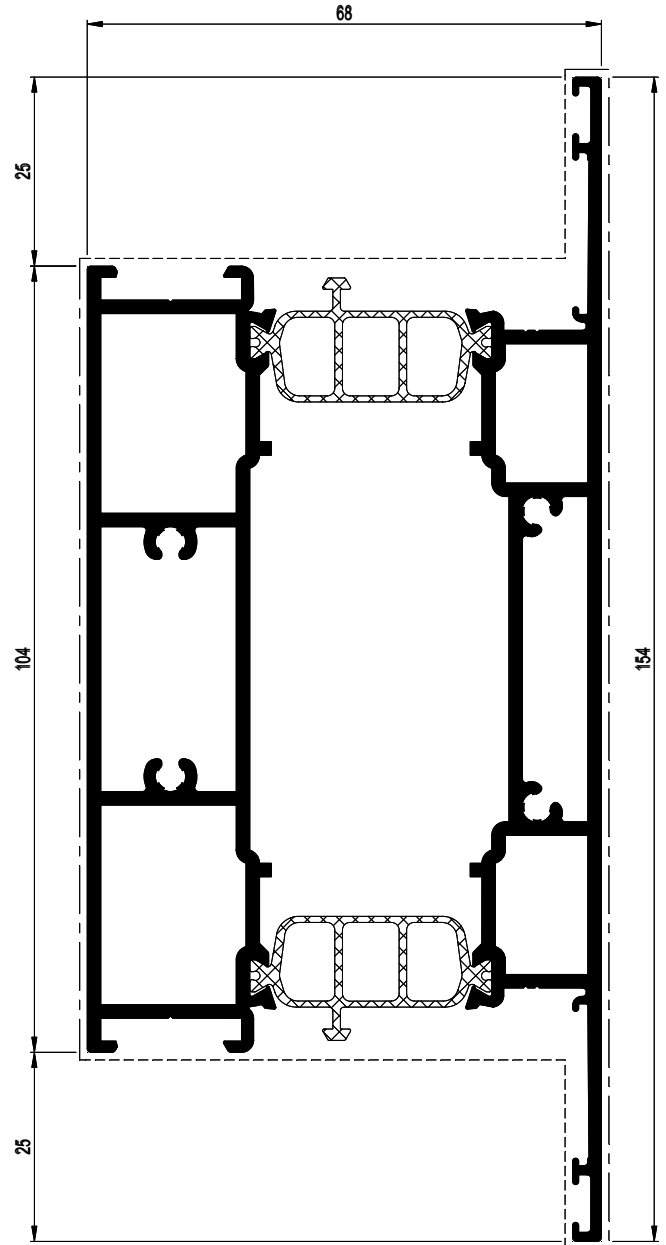

	008.3824.XX	
	052.5316.-- (4x)	---
	068.8734.00	097.P800.00 097.P100.00 097.P200.00 of-ou-or-oder
	050.5153.-- (2x)	097.0410.00
	068.8739.00	097.P800.00 097.P100.00 097.P200.00 of-ou-or-oder
	050.5153.-- (2x)	097.0410.00
	068.8734.00	097.P800.00 097.P100.00 097.P200.00 of-ou-or-oder
	068.5920.-- (2x)	097.0410.00
	068.8739.00	097.P800.00 097.P100.00 097.P200.00 of-ou-or-oder
	068.5920.-- (2x)	097.0410.00
	068.8779.00 (2x) 068.8906.04 (2x) 060.8715/16.00 (2x)	097.0009.00
	060.8746.00 (2x) of 060.8715/16.00 (2x)	---

	0K8.3824.XX	
	052.5315.-- (4x)	---
	068.8734.00	097.P800.00 097.P100.00 097.P200.00 of-ou-or-oder
	050.5153.-- (2x)	097.0410.00
	068.8739.00	097.P800.00 097.P100.00 097.P200.00 of-ou-or-oder
	050.5153.-- (2x)	097.0410.00
	068.8734.00	097.P800.00 097.P100.00 097.P200.00 of-ou-or-oder
	068.5920.-- (2x)	097.0410.00
	068.8739.00	097.P800.00 097.P100.00 097.P200.00 of-ou-or-oder
	068.5920.-- (2x)	097.0410.00
	068.8779.00+(2x) 068.8906.04 (2x) 060.8715/16.00 (2x)	097.0009.00
	060.8746.00 (2x) 060.8715/16.00 (2x)	---

CP 155-LS/HI MINERGIE LABEL

T-PROFIEL
TRAVERSE
TRANSOM
RIEGEL



	A dm ² /m	P dm ² /m	L_m	I_x cm ⁴	W_x cm ³	ax mm	I_y cm ⁴	W_y cm ³	ay mm	X Y X 0
006.0350.XX	52.95	21.2	7.00	78.450	13.602	57.68	53.291	9.707	47.10	

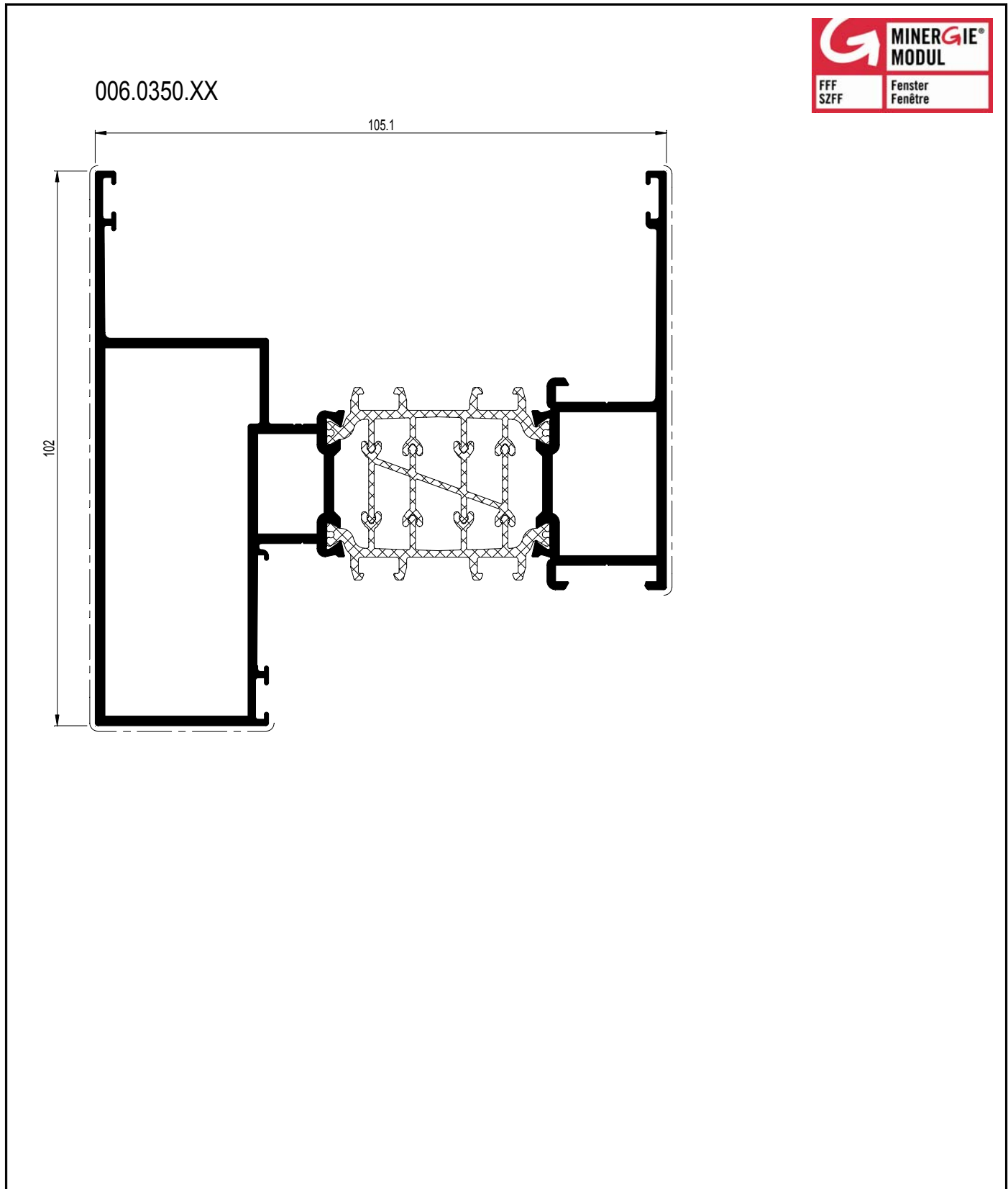

	006.0350.XX	
	068.8731.00	097.0664.00

CP 155 CP 155-LS

WISSELPROFIEL
CHICANE
MEETING SECTION
WECHSELPROFIL



	$\frac{A}{dm^2/m}$	$\frac{P}{dm^2/m}$	$\leftarrow L_m \rightarrow$	$I_x \text{ cm}^4$	$W_x \text{ cm}^3$	$a_x \text{ mm}$	$I_y \text{ cm}^4$	$W_y \text{ cm}^3$	$a_y \text{ mm}$	Y X 0 Y
006.1346.XX	45.10	12.3	6.00	73.951	11.952	34.63	14.650	3.267	14.16	

006.1346.XX

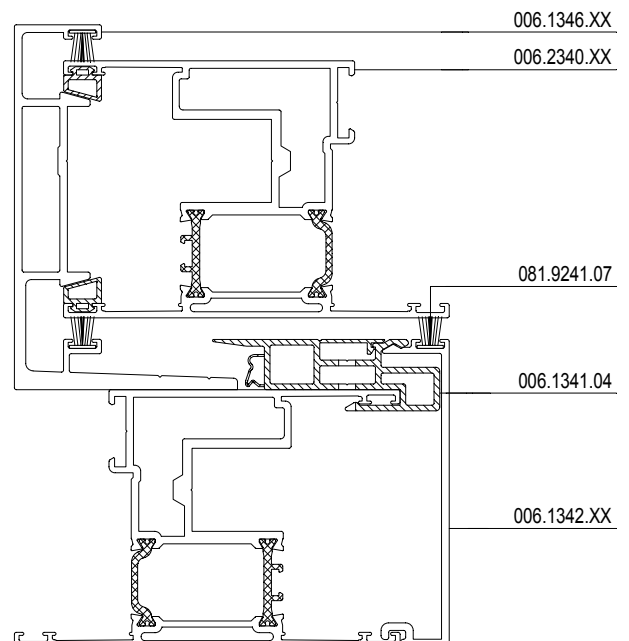
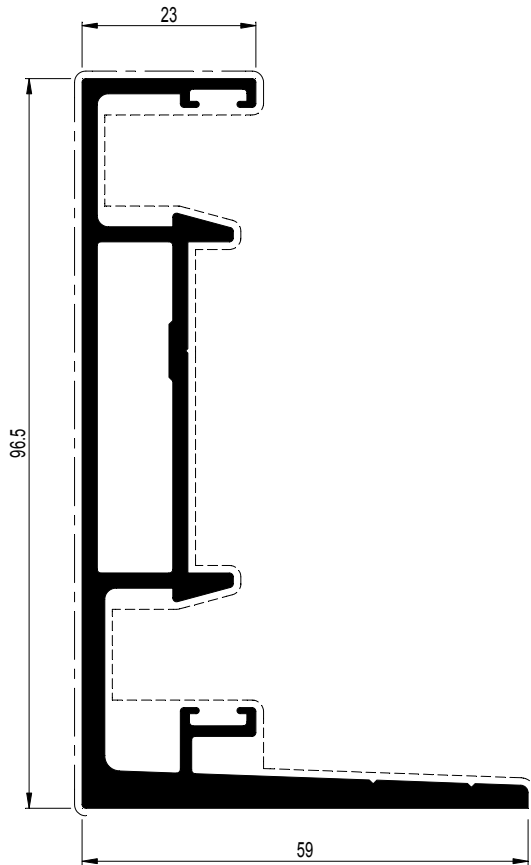

CP 155 CP 155-LS

GLASLATTEN
PARCLOSÉS
GLAZING BEADS
GLASLEISTEN



	A dm ² /m	P dm ² /m	L _m	I _x cm ⁴	W _x cm ³	ax mm	I _y cm ⁴	W _y cm ³	ay mm	
001.0260.XX	14.66	3.6	7.00	0.843	0.544	15.48	0.378	0.319	7.94	
005.0276.XX	16.30	4.3	7.00	1.002	0.585	17.12	0.817	0.673	11.05	
030.3200.XX	10.77	2.9	7.00	0.273	0.191	5.17	0.632	0.362	17.46	
030.3606.XX	12.37	3.4	7.00	0.277	0.198	13.99	0.919	0.612	14.14	
030.3607.XX	15.11	3.7	7.00	0.333	0.255	13.08	0.895	0.581	15.39	
030.3608.XX	15.10	4.0	7.00	0.431	0.354	12.15	0.914	0.560	16.34	
030.3609.XX	15.56	4.3	7.00	0.544	0.483	11.26	0.967	0.572	16.89	
030.3610.XX	16.19	4.6	7.00	0.691	0.646	10.70	1.022	0.590	17.32	
030.3611.XX	16.93	4.9	7.00	0.875	0.690	12.67	1.076	0.609	17.69	

005.0276.XX

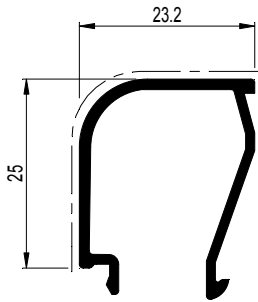

030.3606.XX

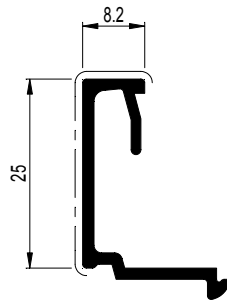

030.3609.XX

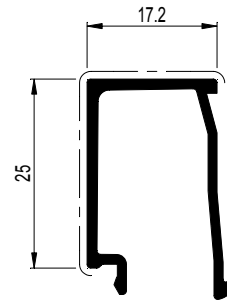

030.3200.XX

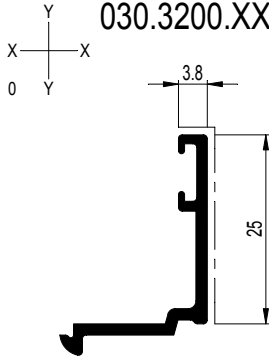

030.3607.XX

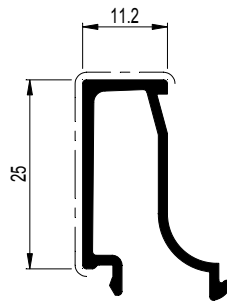

030.3610.XX

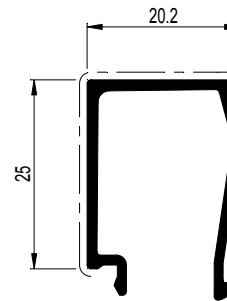

001.0260.XX

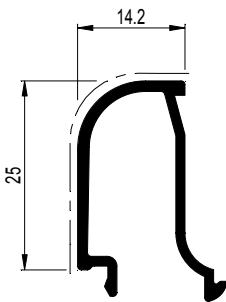

030.3608.XX

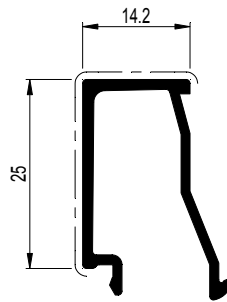

030.3611.XX

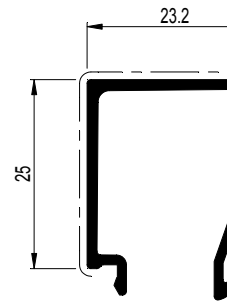

CP 155 CP 155-LS

GLASLATTEN
PARCLOSES
GLAZING BEADS
GLASLEISTEN

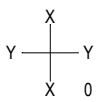

	A dm ² /m	P dm ² /m	L_m	I_x cm ⁴	W_x cm ³	ax mm	I_y cm ⁴	W_y cm ³	ay mm	
030.3612.XX	18.97	5.2	7.00	0.995	0.670	14.85	1.148	0.620	18.53	
030.3613.XX	19.57	5.5	7.00	1.192	0.696	17.13	1.184	0.629	18.81	
030.3614.XX	20.17	5.8	7.00	1.431	0.739	19.37	1.217	0.638	19.07	
030.3615.XX	20.86	6.1	7.00	1.750	0.821	21.31	1.252	0.647	19.35	
030.3616.XX	21.65	6.4	7.00	2.197	0.962	22.85	1.313	0.666	19.70	
030.3617.XX	22.66	6.7	7.00	2.650	1.075	24.65	1.369	0.677	20.24	
030.3618.XX	23.46	7.0	7.00	3.139	1.184	26.50	1.404	0.686	20.46	
030.3619.XX	23.86	7.3	7.00	3.601	1.257	28.65	1.429	0.693	20.61	

030.3612.XX

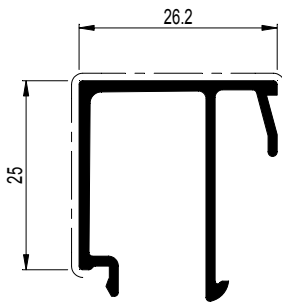

030.3615.XX

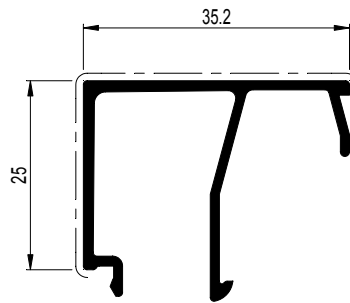

030.3618.XX

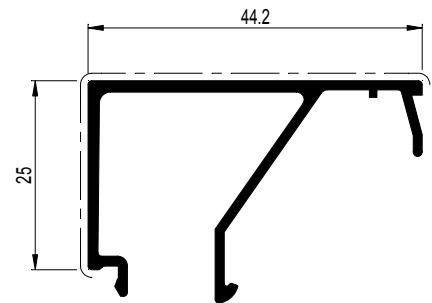

030.3613.XX

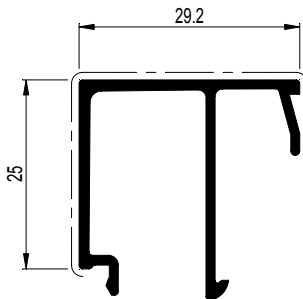

030.3616.XX

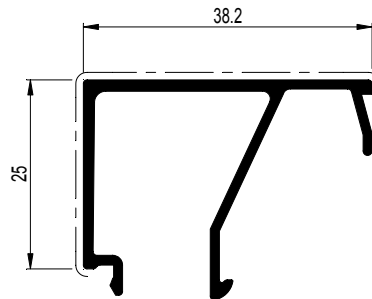

030.3619.XX

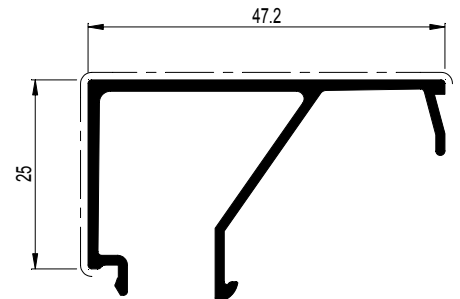

030.3614.XX

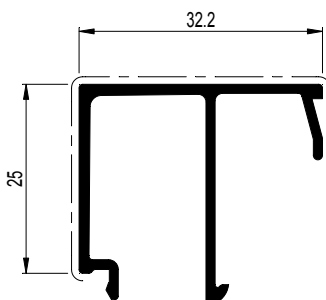

030.3617.XX

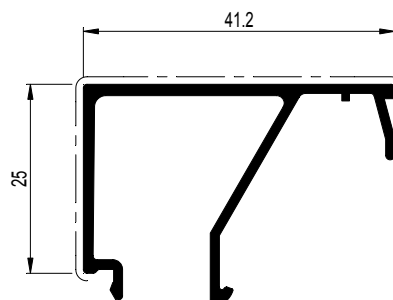

CP 155-AP CP 155-LS/AP

GLASLATTEN INBRAAKWEREND
PARCLOSES PROTECTION ANTI-VOL
GLAZING BEADS BURGLAR PROTECTION
GLASLEISTEN EINBRUCHHEMMEND



	$\frac{A}{dm^2/m}$	$\frac{P}{dm^2/m}$	$\leftarrow L_m \rightarrow$	$I_x \text{ cm}^4$	$W_x \text{ cm}^3$	ax mm	$I_y \text{ cm}^4$	$W_y \text{ cm}^3$	ay mm	
030.3644.XX	10.24	2.8	7.00	0.291	0.213	13.64	0.560	0.299	9.46	
030.3645.XX	10.80	3.1	7.00	0.293	0.213	13.79	0.737	0.423	10.79	
030.3646.XX	13.06	3.4	7.00	0.296	0.219	13.52	0.957	0.618	12.72	
030.3647.XX	9.74	3.7	7.00	0.376	0.315	11.94	1.072	0.699	12.86	
030.3648.XX	9.83	4.0	7.00	0.447	0.398	11.23	1.148	0.780	13.48	
030.3649.XX	9.94	4.3	7.00	0.548	0.520	10.55	1.211	0.857	14.13	
030.3650.XX	10.37	4.6	7.00	0.736	0.703	10.47	1.297	0.898	14.44	

030.3644.XX

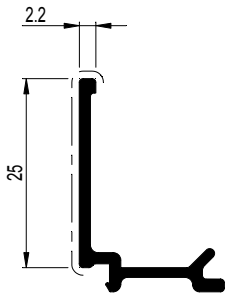

030.3647.XX

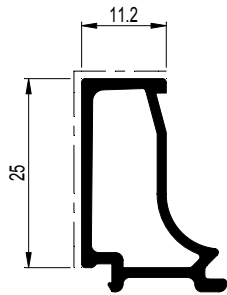

030.3650.XX

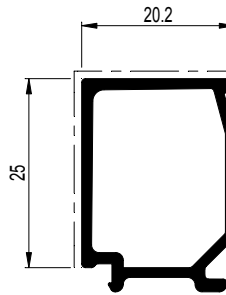

030.3645.XX

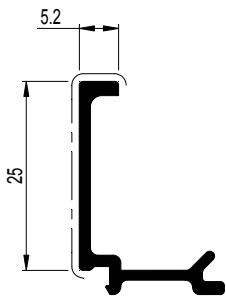

030.3648.XX

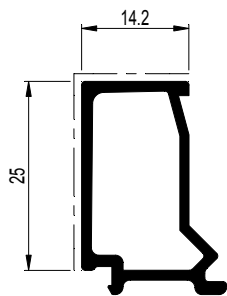

030.3646.XX

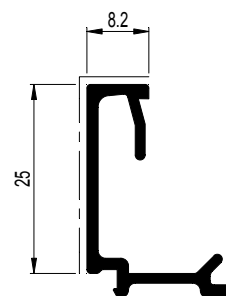

030.3649.XX

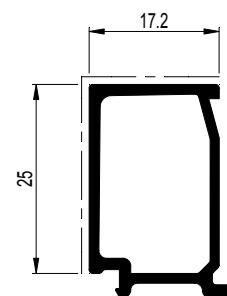

- 030.3644.XX
- 030.3645.XX
- 030.3646.XX
- 030.3647.XX
- 030.3648.XX
- 030.3649.XX
- 030.3650.XX

A = min. 7mm

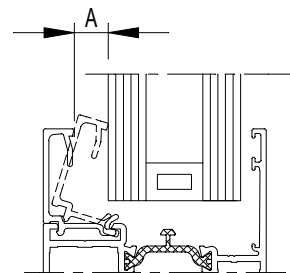

- 030.3200.XX
- 030.3606.XX
- 030.3607.XX
- 030.3608.XX
- 030.3609.XX
- 030.3610.XX
- 030.3611.XX
- 030.3612.XX
- 030.3613.XX
- 030.3614.XX
- 030.3615.XX
- 030.3616.XX
- 030.3617.XX
- 030.3618.XX
- 030.3619.XX
- 005.0276.XX

A = min. 4mm

CP 155 CP 155-LS

ROLLUIKGELEIDERS
GUIDES A VOLET
SHUTTER GUIDES
ROLLADENFUEHRUNGEN



	A dm ² /m	P dm ² /m	L _m	I _x cm ⁴	W _x cm ³	a _x mm	I _y cm ⁴	W _y cm ³	a _y mm	
004.3130.XX	19.05	1.6	6.00	1.141	0.774	27.84	1.881	0.675	11.18	
004.3843.XX	23.68	8.0	6.00	4.009	1.264	10.47	1.621	0.952	15.29	
030.1143.XX	22.89	7.8	6.00	3.495	1.143	14.53	2.214	1.076	20.57	

004.3130.XX

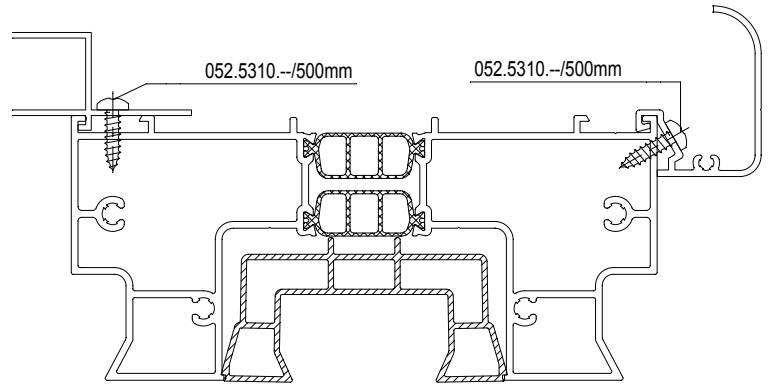
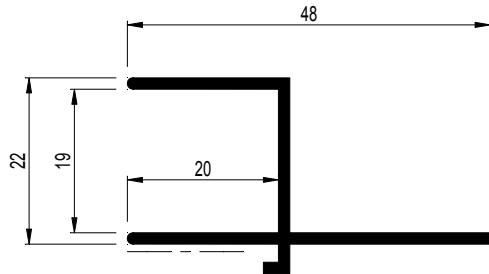

004.3843.XX

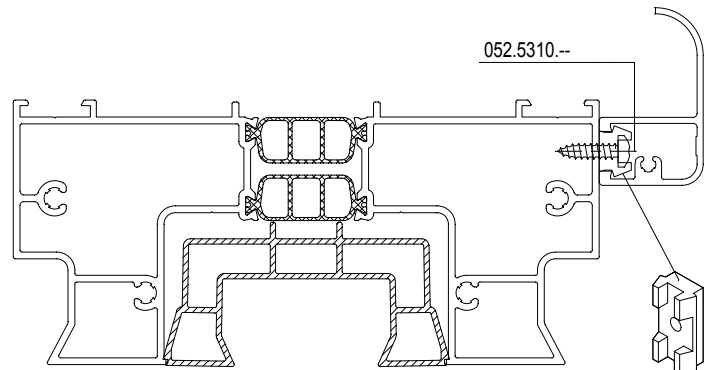
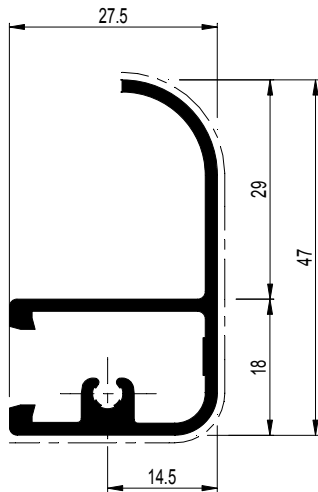

068.6351.04
2/m

030.1143.XX

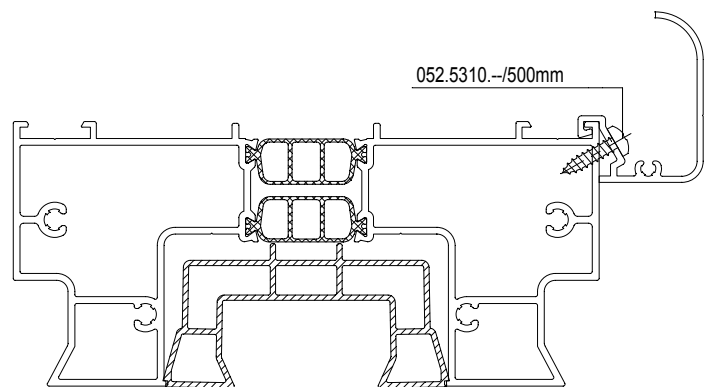
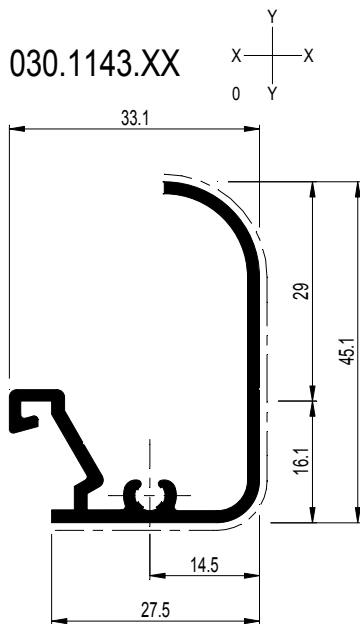

CP 155 CP 155-LS

ROLLUIKGELEIDERS
GUIDES A VOLET
SHUTTER GUIDES
ROLLADENFUEHRUNGEN



	A dm ² /m	P dm ² /m	L _m	I _x cm ⁴	W _x cm ³	ax mm	I _y cm ⁴	W _y cm ³	ay mm	
004.3167.XX	35.96	12.8	6.00	9.873	3.327	28.51	3.238	2.151	12.95	
030.1142.XX	35.19	7.0	6.00	13.153	3.911	31.19	3.015	1.909	15.79	

004.3167.XX

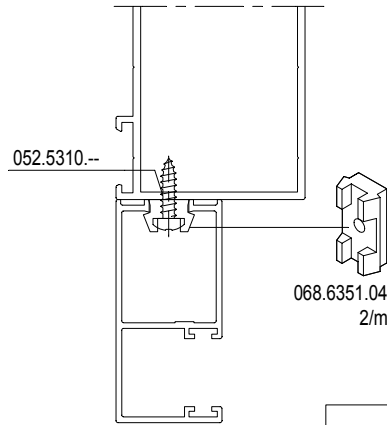
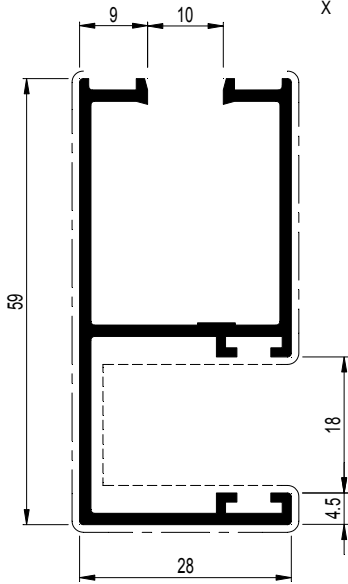

		X=
081.9092.04	081.9092.04	10mm
081.9092.04	081.9091.04	12mm
081.9091.04	081.9091.04	14mm
081.9091.04	-	16mm

030.1142.XX

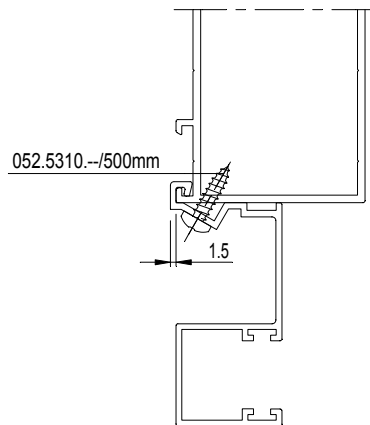
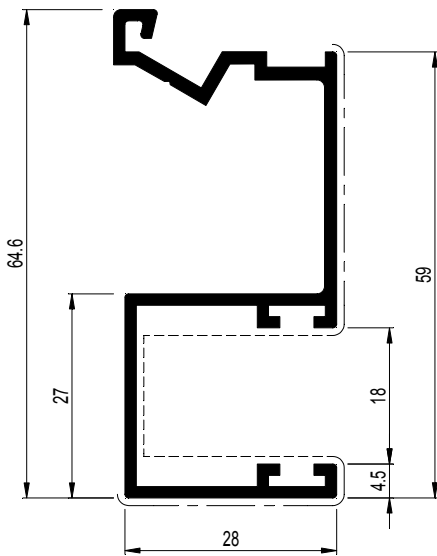

CP 155 CP 155-LS

ROLLUIKGELEIDERS
GUIDES A VOLET
SHUTTER GUIDES
ROLLADENFUEHRUNGEN



	$\frac{A}{dm^2/m}$	$\frac{P}{dm^2/m}$	$\leftarrow L_m \rightarrow$	$I_x \text{ cm}^4$	$W_x \text{ cm}^3$	ax mm	$I_y \text{ cm}^4$	$W_y \text{ cm}^3$	ay mm	
004.3168.XX	54.76	30.3	6.00	41.102	8.444	47.32	5.965	3.932	12.83	Y X 0
030.1147.XX	30.35	11.5	6.00	15.647	3.748	28.56	4.383	1.287	11.04	X Y 0

004.3168.XX

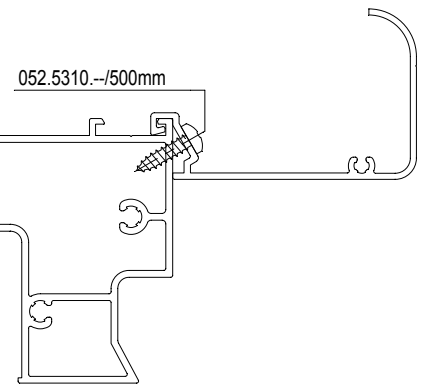
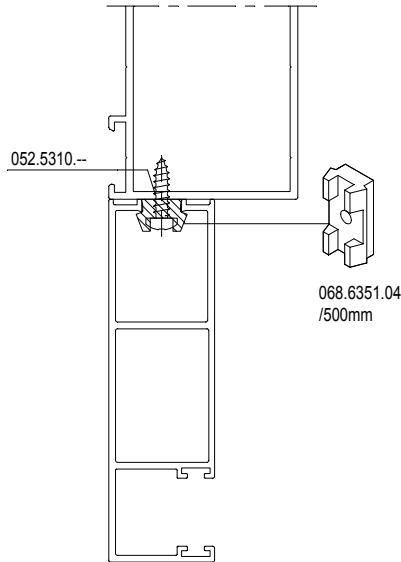
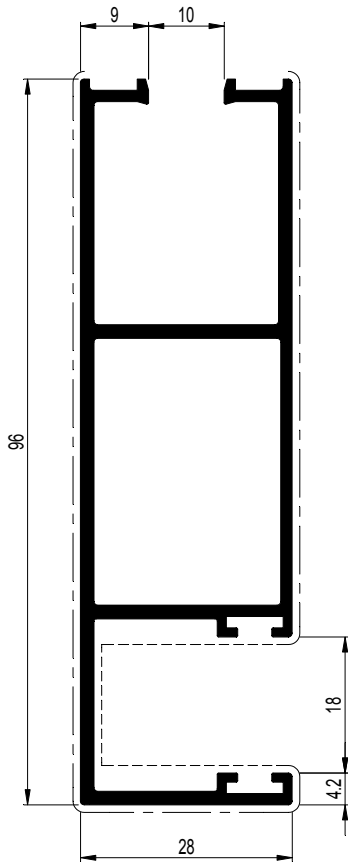

030.1147.XX

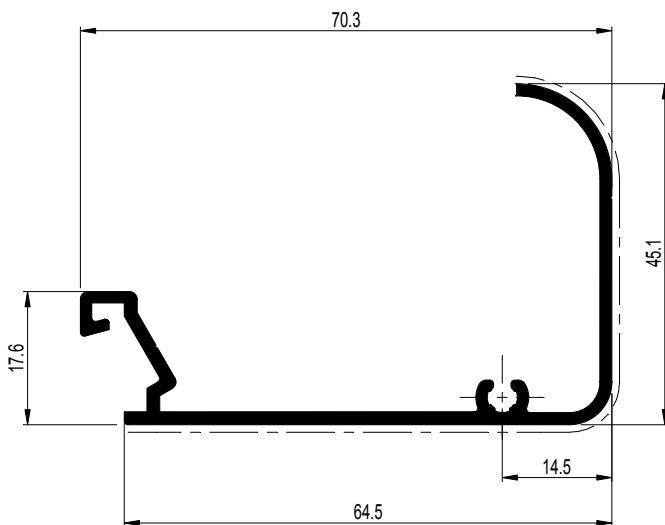

CP 155 CP 155-LS

DILATATIEPROFIEL
PROFIE DE DILATATION
EXPANSION PROFILE
AUSDEHNUNGSPROFIL

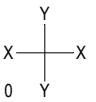

	$\frac{A}{dm^2/m}$	$\frac{P}{dm^2/m}$	L_m	$I_x \text{ cm}^4$	$W_x \text{ cm}^3$	ax mm	$I_y \text{ cm}^4$	$W_y \text{ cm}^3$	ay mm	
030.0080.XX	18.20	2.9	7.00	0.522	0.470	11.12	0.979	0.633	14.05	X 0 Y

030.0080.XX

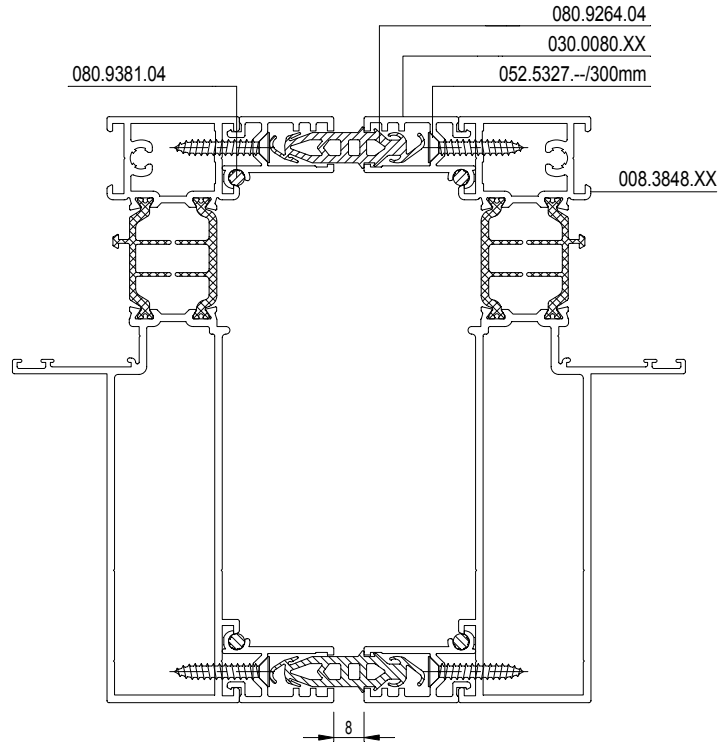
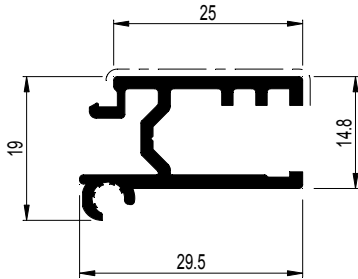

D0074999

CP 155 CP 155-LS

KOPPELPROFIEL
PROFIE DE RACCORDEMENT
CONNECTION PROFILE
KUPPLUNGSPROFIL



	A dm ² /m	P dm ² /m	L_m	I_x cm ⁴	W_x cm ³	a_x mm	I_y cm ⁴	W_y cm ³	a_y mm	Y X 0 Y
008.3848.XX	49.15	18.7	7.00	163.672	20.376	80.33	16.564	4.166	20.24	

008.3848.XX

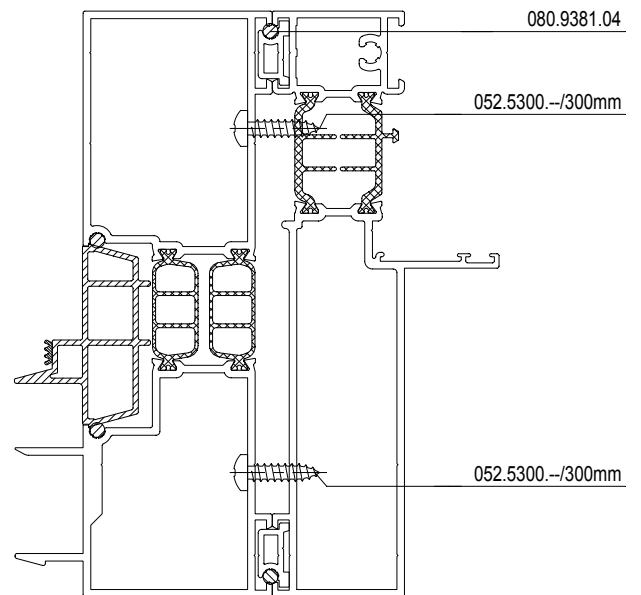
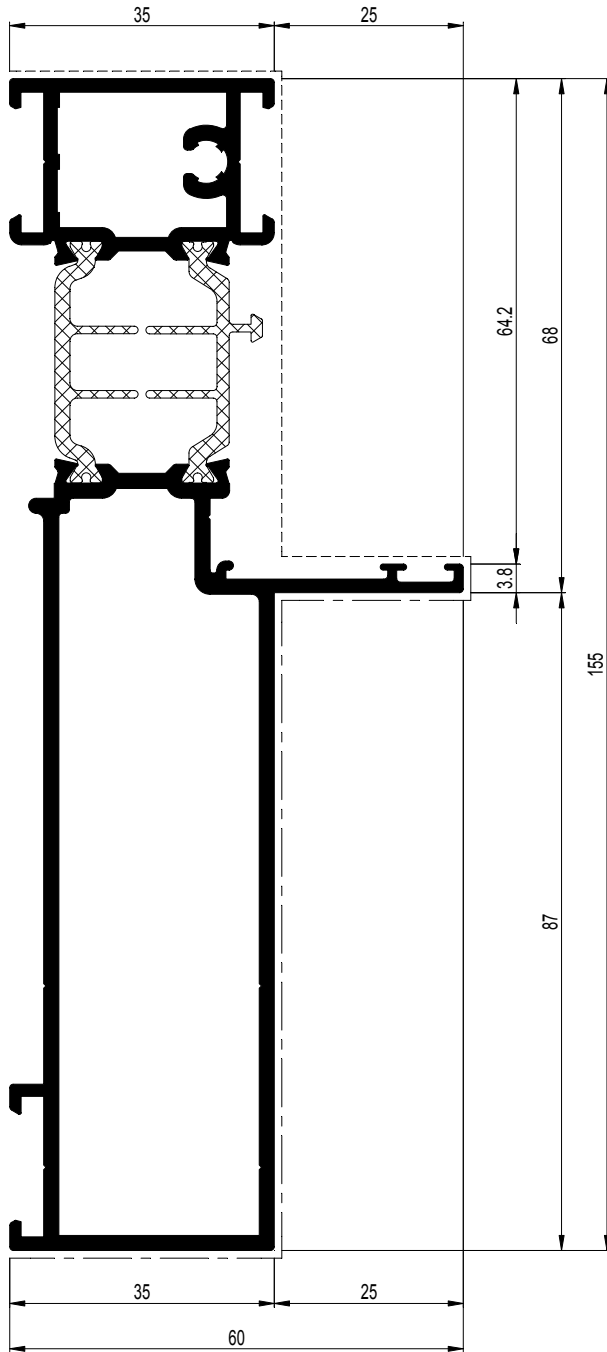

	008.3848.XX	
	068.7633.00	095.H800.00 of-ou-or-oder 095.B500.00
	060.8723.-- (or) 060.8746.00	--

CP 155 CP 155-LS

AFWERKINGSPROFIEL
PROFILE DE FINITION
FINISHING PROFILE
AUSFUEHRUNGSPROFIL



	A dm ² /m	P dm ² /m	Lm	Ix cm ⁴	Wx cm ³	ax mm	Iy cm ⁴	Wy cm ³	ay mm	X Y X 0
006.0370.XX	45.15	5.3	7.00	147.133	18.107	71.65	5.660	1.431	39.55	
009.1886.XX	18.47	3.1	7.00	0.884	0.812	9.31	3.914	1.307	20.07	
043.1028.XX	9.59	2.3	6.00	-	-	-	-	-	-	

006.0370.XX

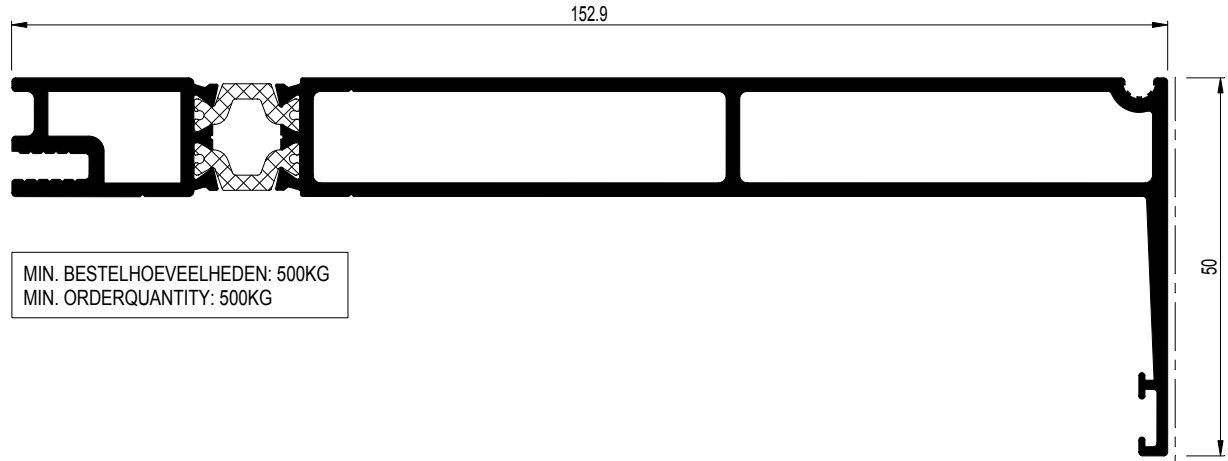

MIN. BESTELHOEVEELHEDEN: 500KG
MIN. ORDERQUANTITY: 500KG

009.1886.XX

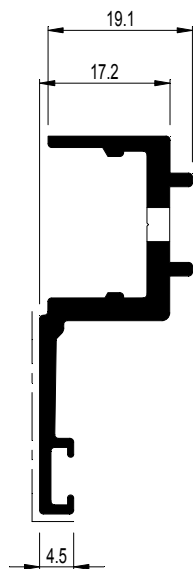

043.1028.XX

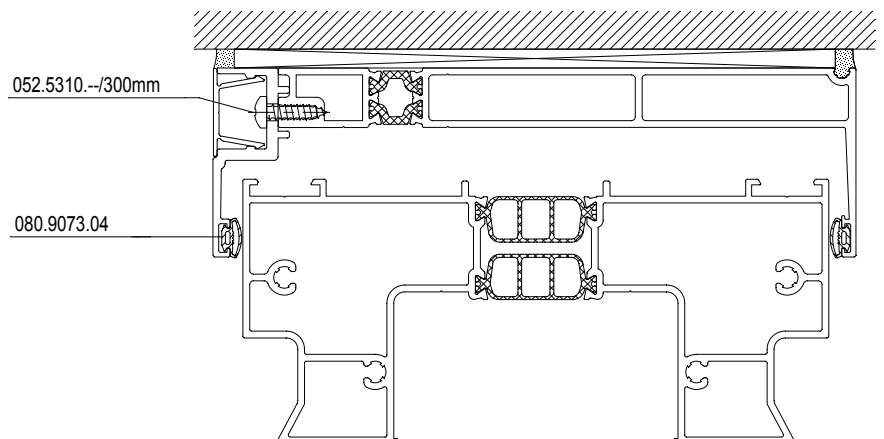
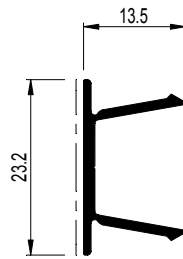

CP 155 CP 155-LS

HULPPROFIELEN
PROFILES DE RACCORDEMENT
ADDITIONAL PROFILES
ZUSATZPROFILE



	$\frac{A}{dm^2/m}$	$\frac{P}{dm^2/m}$	$\leftarrow L_m \rightarrow$	$I_x \text{ cm}^4$	$W_x \text{ cm}^3$	ax mm	$I_y \text{ cm}^4$	$W_y \text{ cm}^3$	ay mm	
030.3370.XX	11.80	2.4	7.00	0.253	0.197	5.14	0.640	0.342	18.69	
030.3890.XX	18.33	2.8	7.00	0.682	0.648	7.58	1.066	0.765	13.93	

030.3370.XX

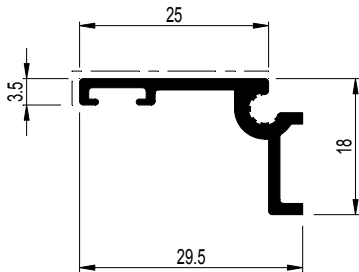

030.3890.XX

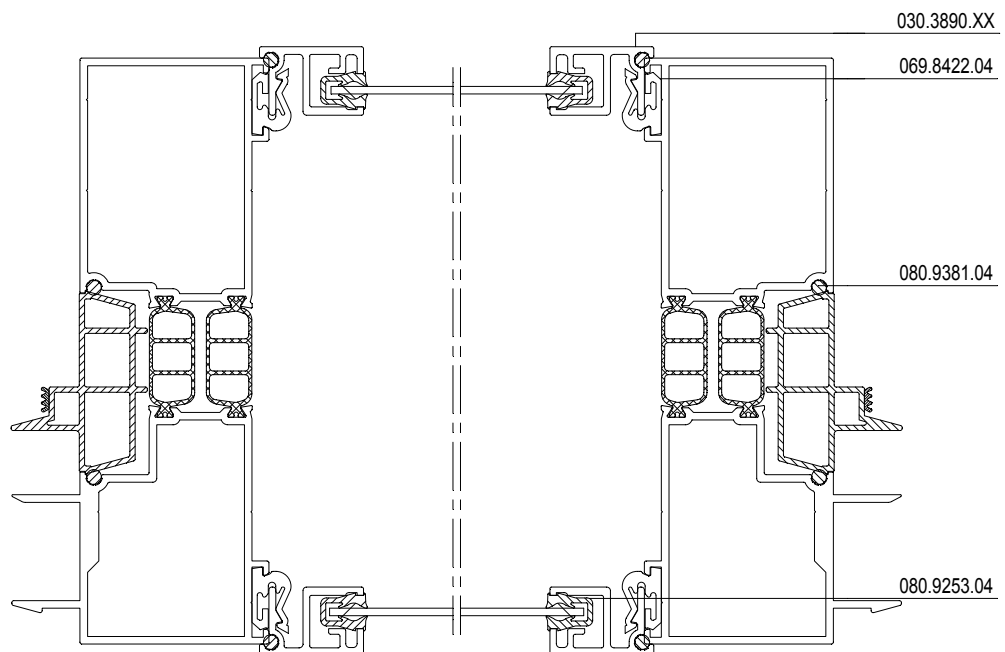
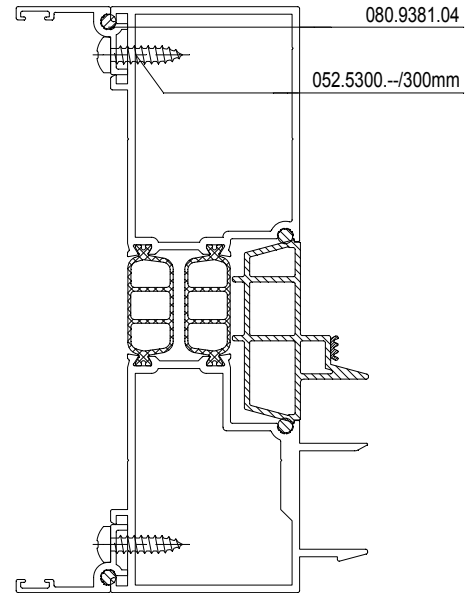
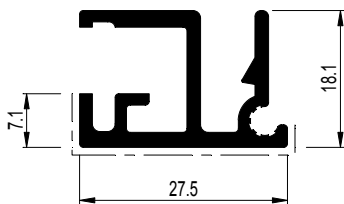

CP 155 CP 155-LS

AFWERKINGSPROFIEL
PROFIE DE FINITION
FINISHING PROFILE
AUSFUEHRUNGSPROFIL



	A dm ² /m	P dm ² /m	L_m	I_x cm ⁴	W_x cm ³	a_x mm	I_y cm ⁴	W_y cm ³	a_y mm	Y X 0 Y
030.2140.00	24.48	-	7.00	6.246	1.780	19.80	2.235	1.219	18.34	
030.2141.00	-	-	7.00	5.613	1.672	21.03	1.162	0.793	14.65	

030.2140.00

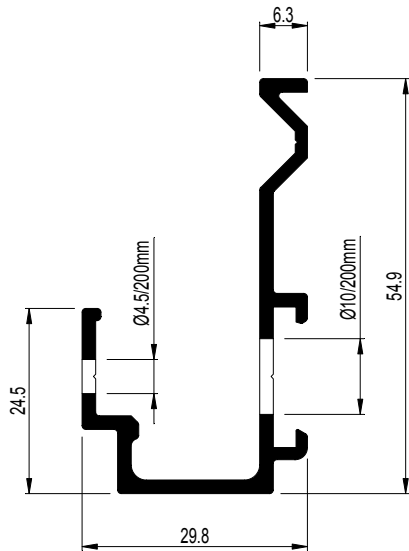

030.2141.00

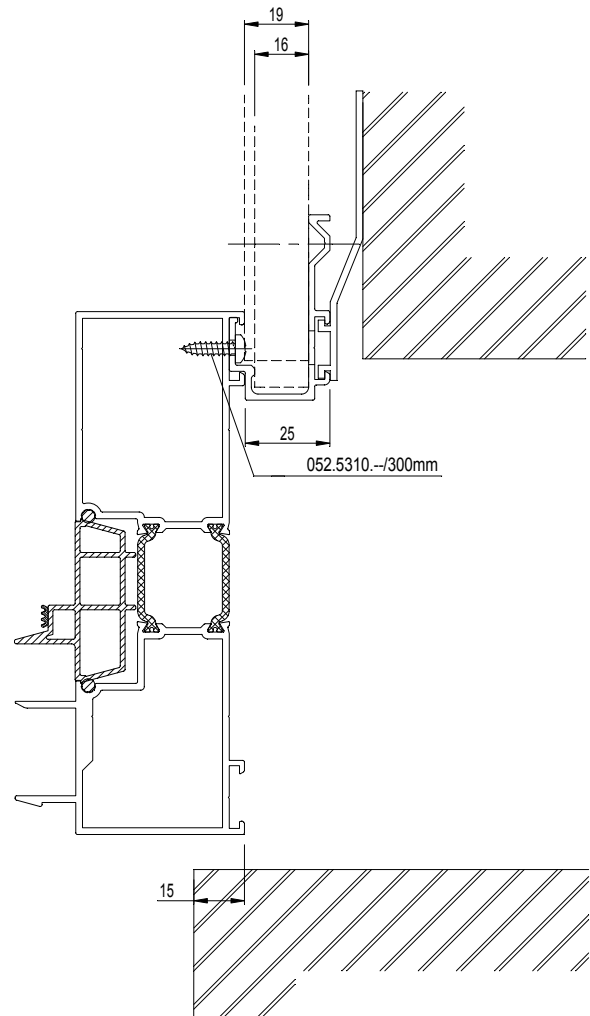
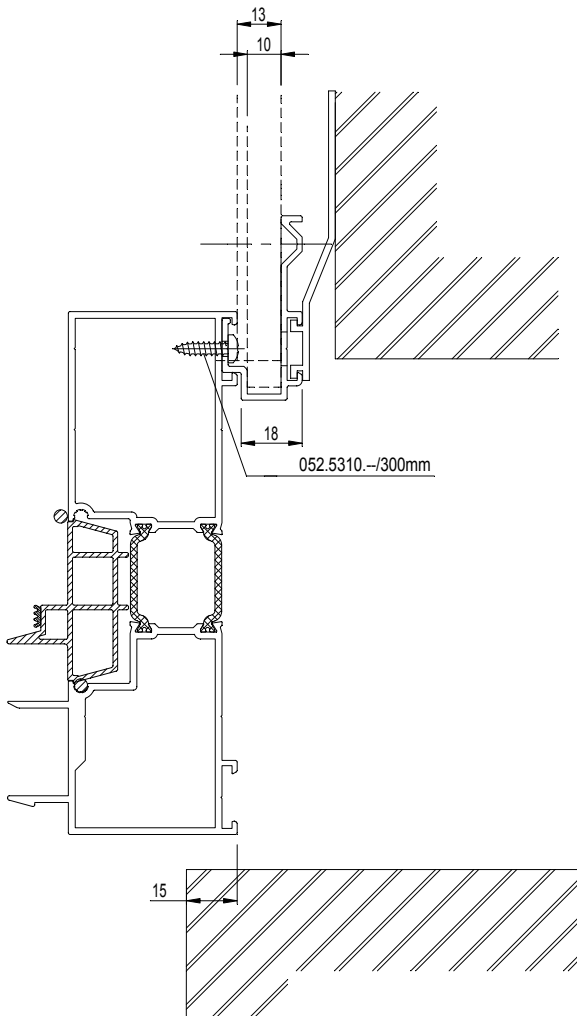
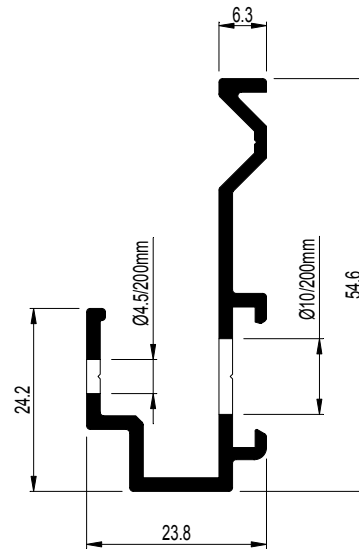

CP 155-LS/HI MINERGIE LABEL

WISSELPROFIEL
CHICANE
MEETING SECTION
WECHSELPROFIL



	A dm ² /m	P dm ² /m	L_m	I_x cm ⁴	W_x cm ³	a_x mm	I_y cm ⁴	W_y cm ³	a_y mm	Y X 0 Y
006.0351.XX	32.45	13.2	7.00	50.742	8.102	55.77	0.663	0.451	3.30	

006.0351.XX

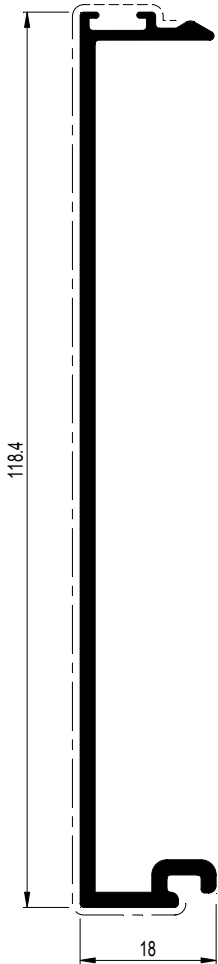

D00084600

CP 155-LS

AFDEKKAP MOTOR
 CAPUCHON POUR MOTEUR
 COVER MOTOR
 ABDECKKAPPE ANTRIEB



	$\frac{A}{dm^2/m}$	$\frac{P}{dm^2/m}$	$\leftarrow L_m \rightarrow$	$I_x \text{ cm}^4$	$W_x \text{ cm}^3$	$a_x \text{ mm}$	$I_y \text{ cm}^4$	$W_y \text{ cm}^3$	$a_y \text{ mm}$	
006.0365.XX	26.92	12.4	7.00	4.099	1.096	11.10	13.144	3.332	28.55	

006.0365.XX

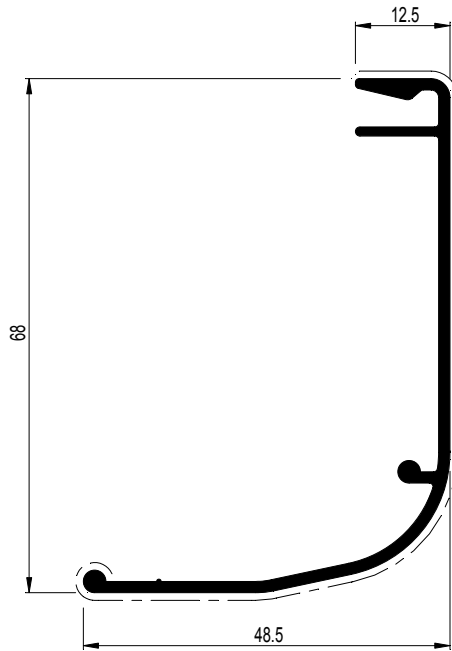

	A dm ² /m	P dm ² /m	L _m	I _x cm ⁴	W _x cm ³	a _x mm	I _y cm ⁴	W _y cm ³	a _y mm	
006.0317.XX	18.81	6.2	7.00	1.532	1.473	10.41	7.627	2.667	26.21	Y X 0
006.0318.XX	26.03	7.9	7.00	1.889	1.713	8.98	20.289	4.479	45.30	
007.0767.01			7.00	-	-	-	-	-	-	

006.0317.XX

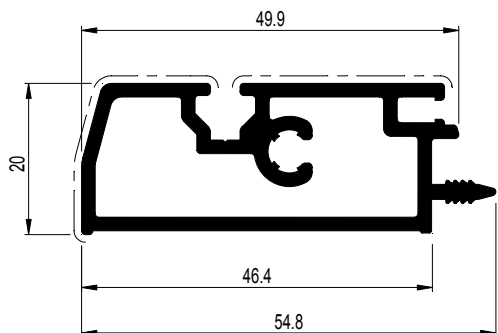

007.0767.01

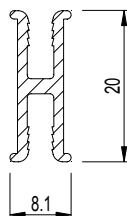

006.0318.XX

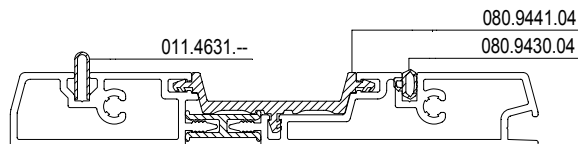
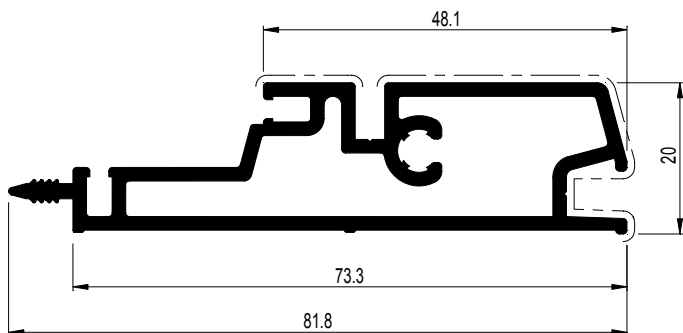

	006.0317.XX	
	052.5371.--	097.0014.00

	006.0318.XX	
	052.5371.--	097.0014.00

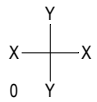
	$\frac{A}{dm^2/m}$	$\frac{P}{dm^2/m}$	$\leftarrow L_m \rightarrow$	$I_x \text{ cm}^4$	$W_x \text{ cm}^3$	ax mm	$I_y \text{ cm}^4$	$W_y \text{ cm}^3$	ay mm	
030.1135.XX	16.11	1.6	7.00	1.616	0.832	19.41	0.266	0.239	7.06	

030.1135.XX

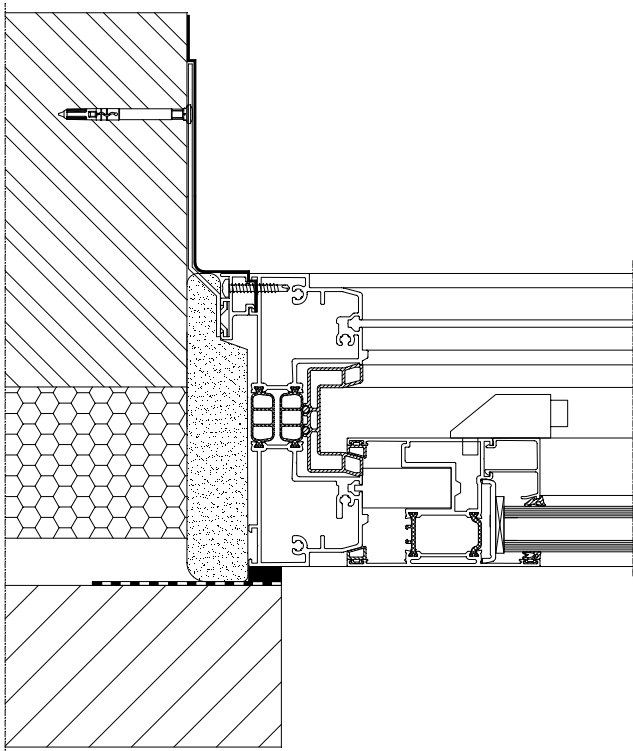
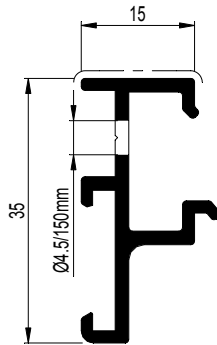

CP 155

BEVESTIGINGSPROFIEL REYNACONNECT
SUPPORT DE MONTAGE REYNACONNECT
FIXATION PROFILE REYNACONNECT
BEFESTIGUNGSPROFIL REYNACONNECT



E

R
REYNAERS
aluminium

Werktekeningen
Coupes et débits
Work drawings
Werkzeichnungen

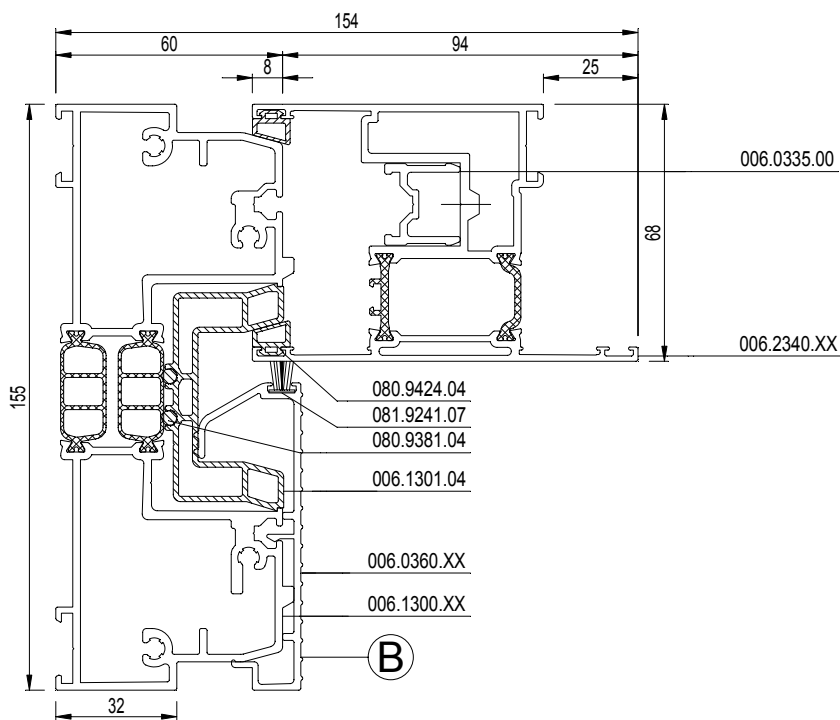
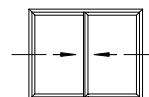
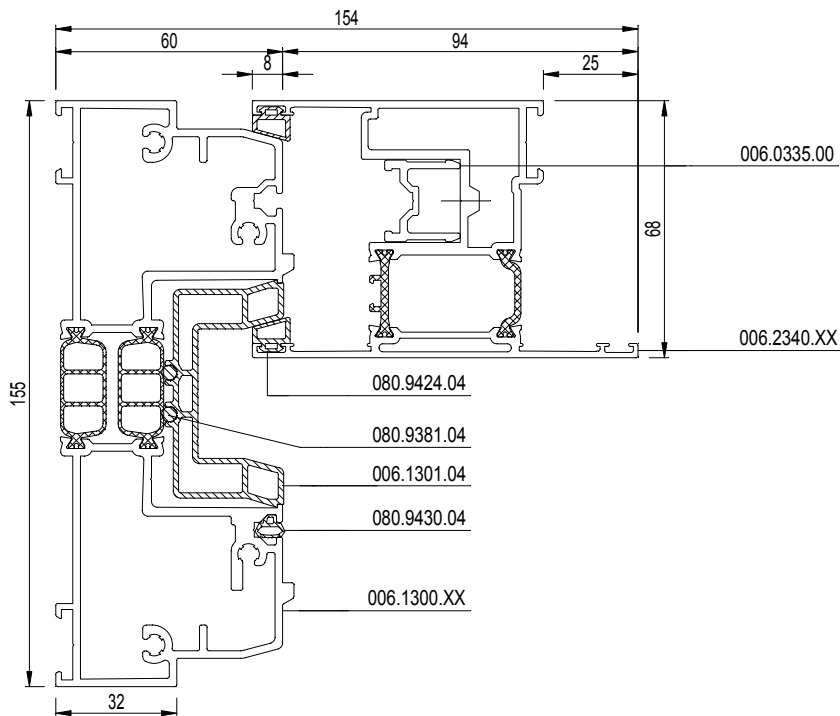
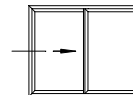

VARIANT HI
 VARIANTE HI
 VARIANT HI
 VARIANT HI

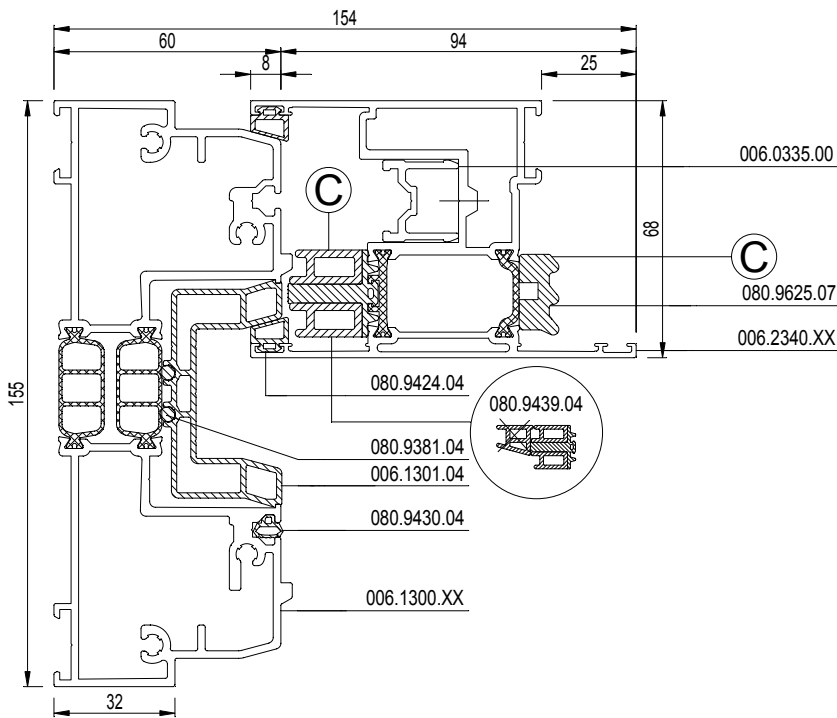
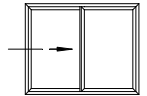

VARIANT HI
 VARIANTE HI
 VARIANT HI
 VARIANT HI

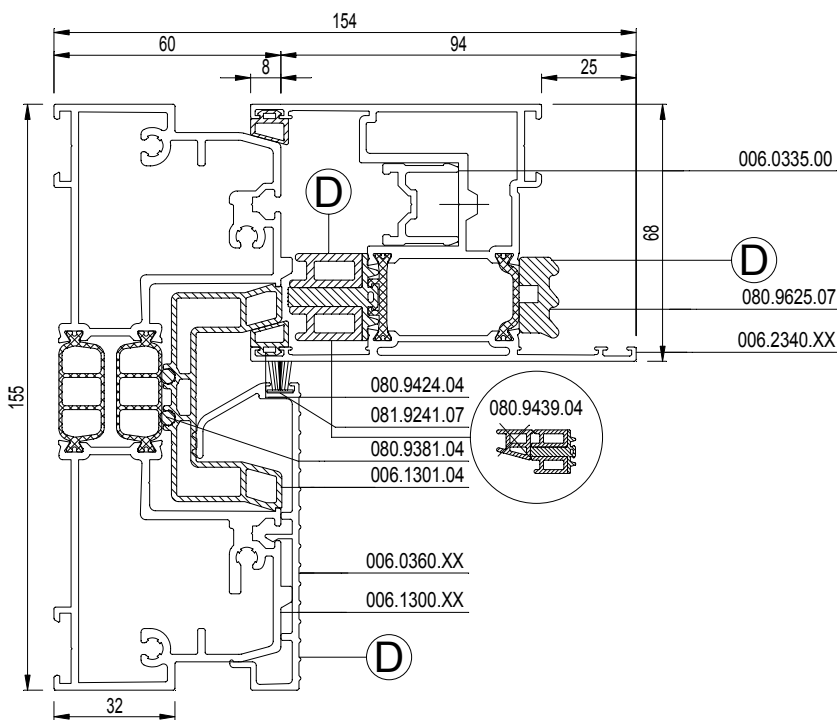
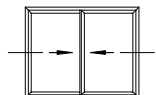

schaal - échelle
 scale - Maßstab
 1/2

D007872

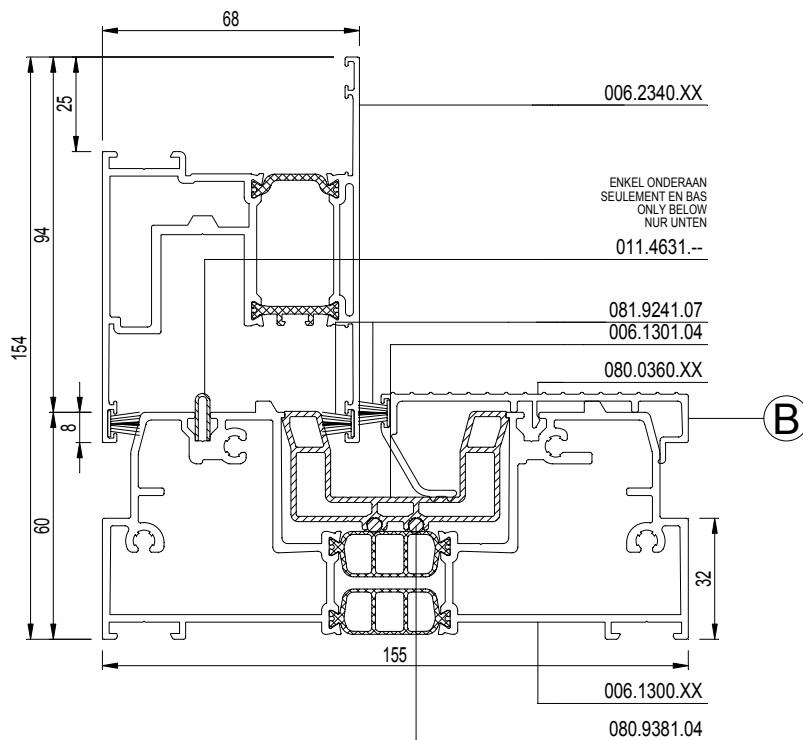
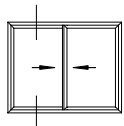
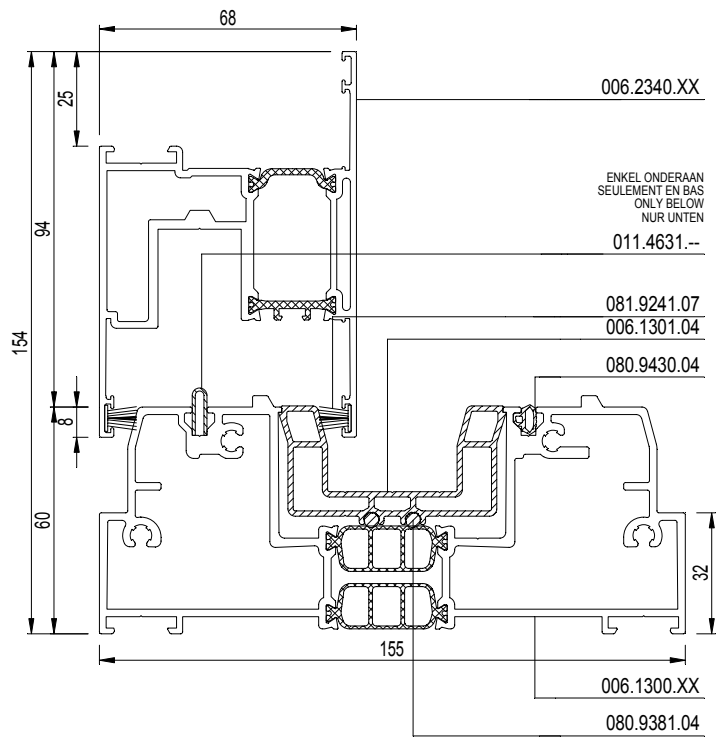
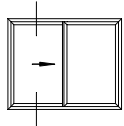

schaal - échelle
 scale - Maßstab
 1/2
 D0078774

VARIANT HI
 VARIANTE HI
 VARIANT HI
 VARIANT HI

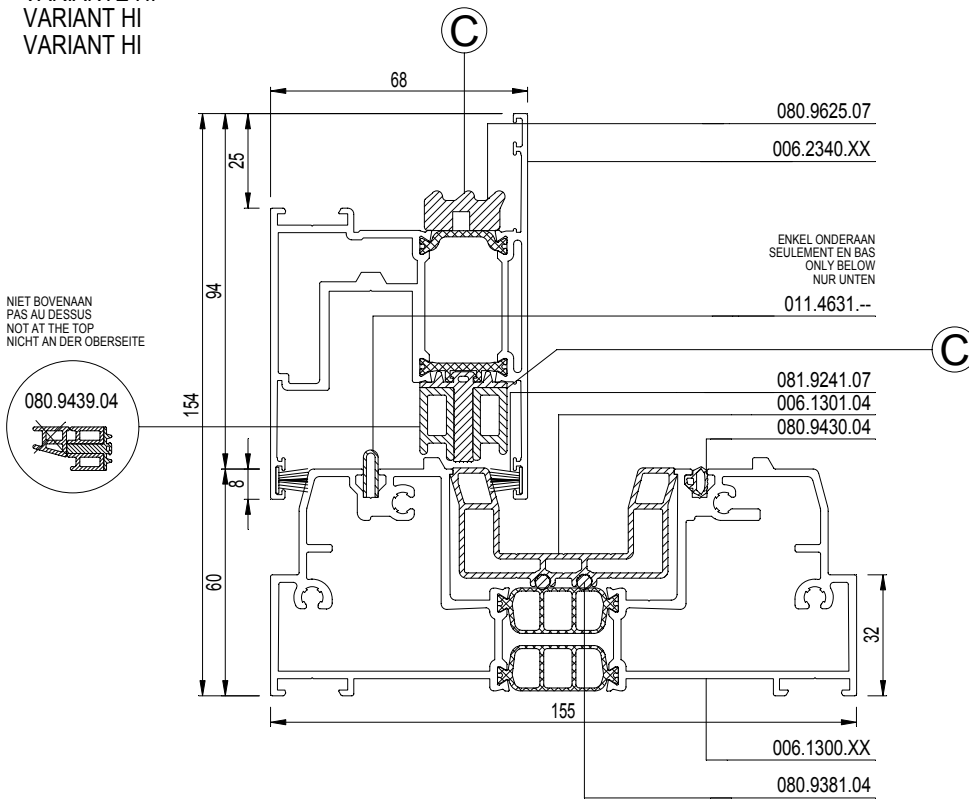
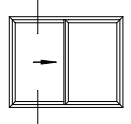

VARIANT HI
 VARIANTE HI
 VARIANT HI
 VARIANT HI

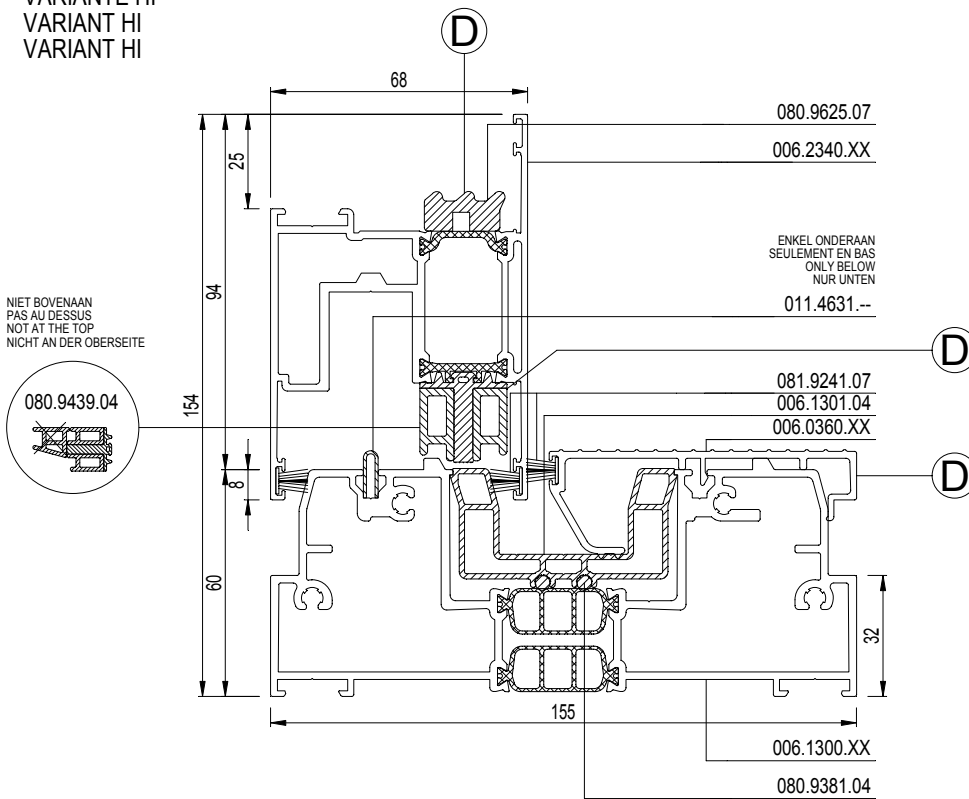
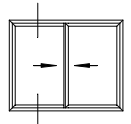

schaal - échelle
 scale - Maßstab
 1/2

D007874

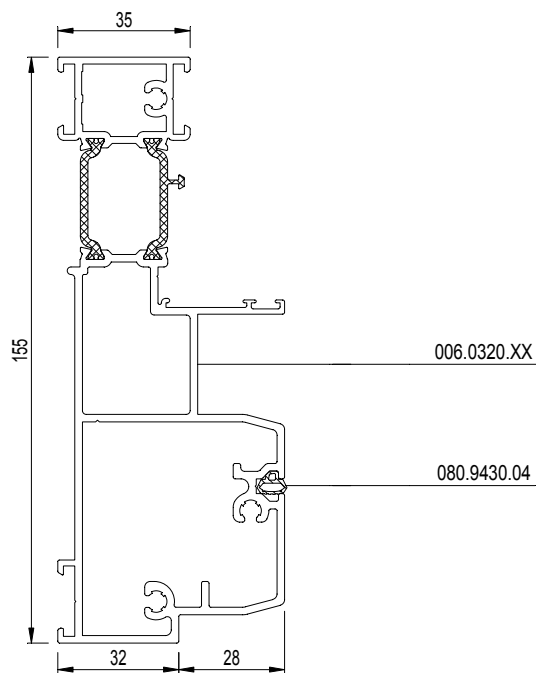
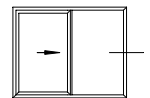
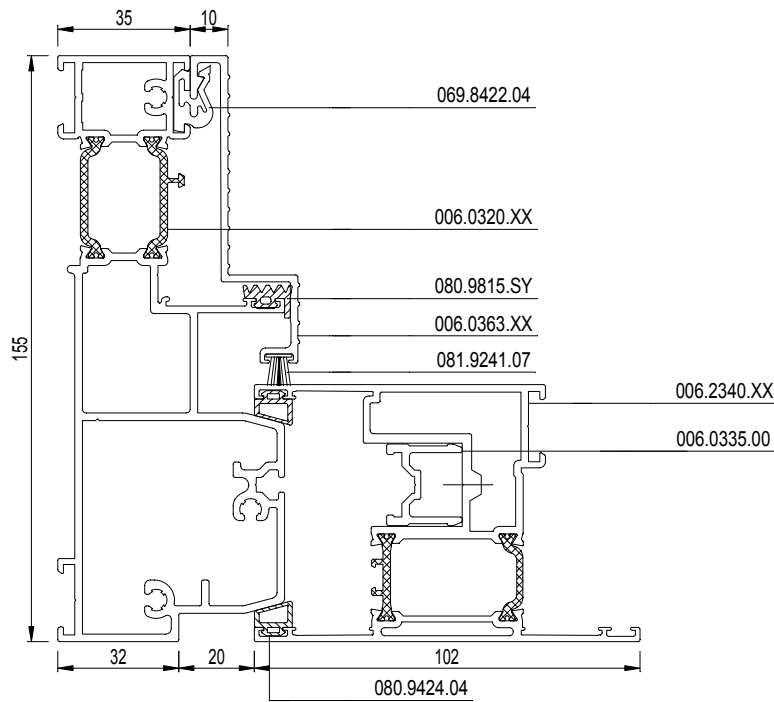
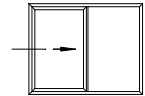

VARIANT HI
 VARIANTE HI
 VARIANT HI
 VARIANT HI

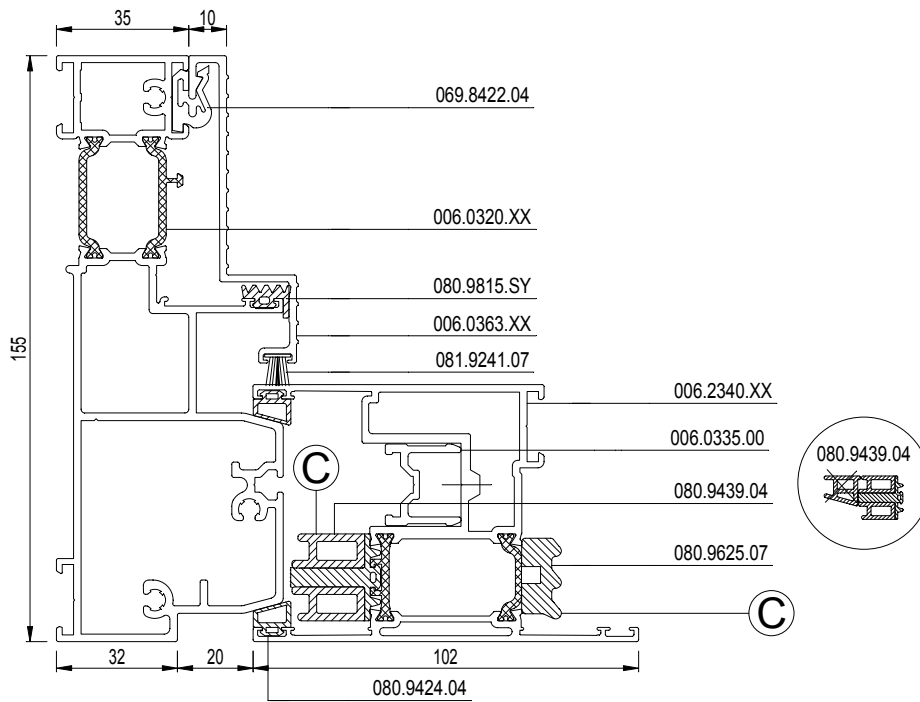
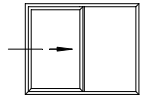

VARIANT HI
 VARIANTE HI
 VARIANT HI
 VARIANT HI

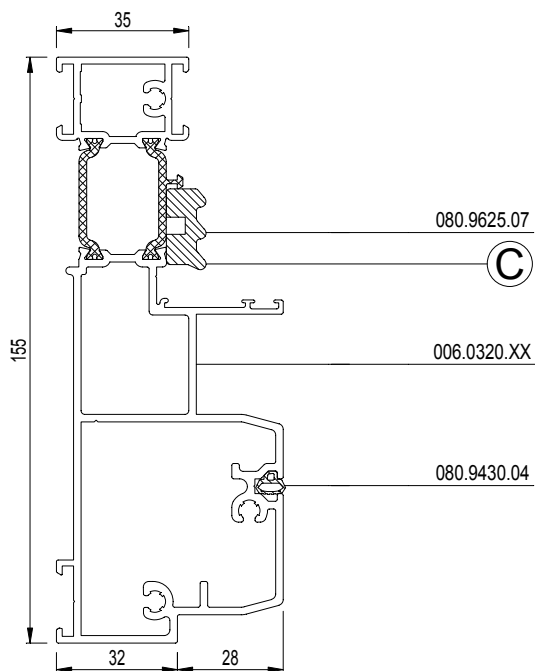
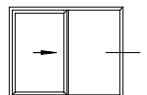

schaal - échelle
 scale - Maßstab
 1/2

D0083930

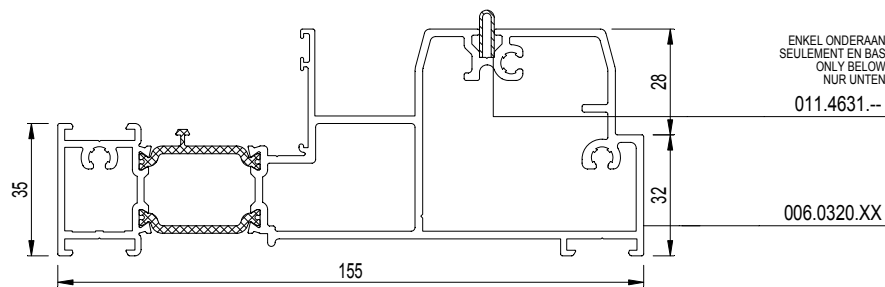
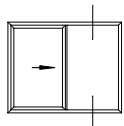
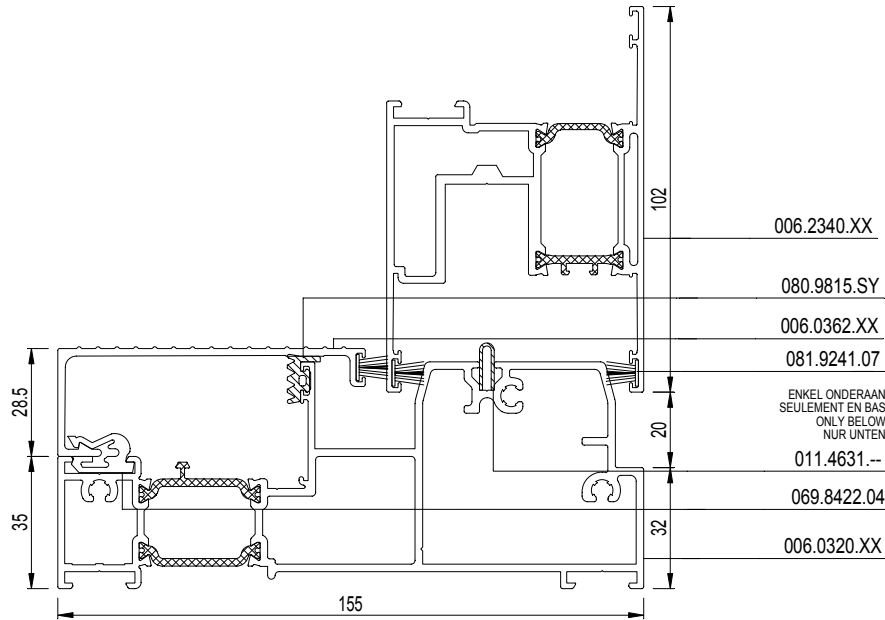
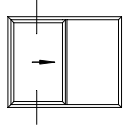

VARIANT HI
 VARIANTE HI
 VARIANT HI
 VARIANT HI

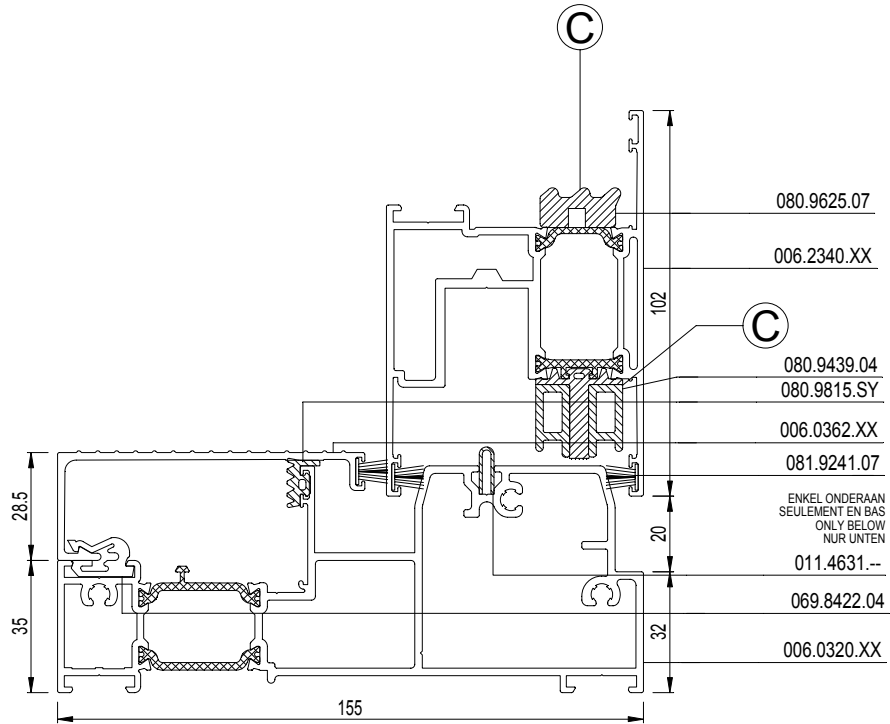
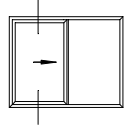

VARIANT HI
 VARIANTE HI
 VARIANT HI
 VARIANT HI

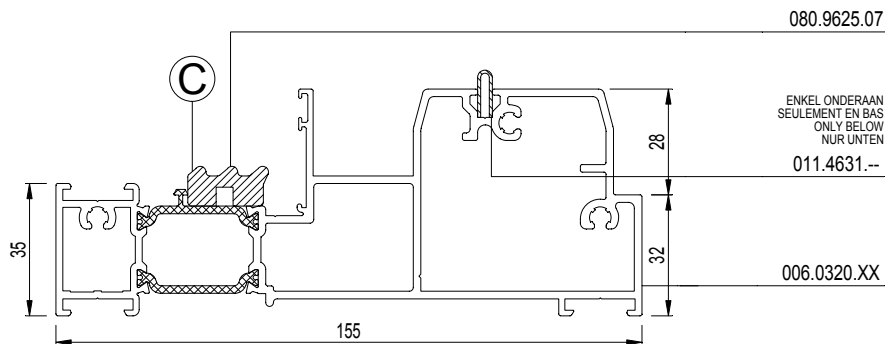
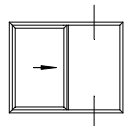

schaal - échelle
 scale - Maßstab
 1/2

D0090014

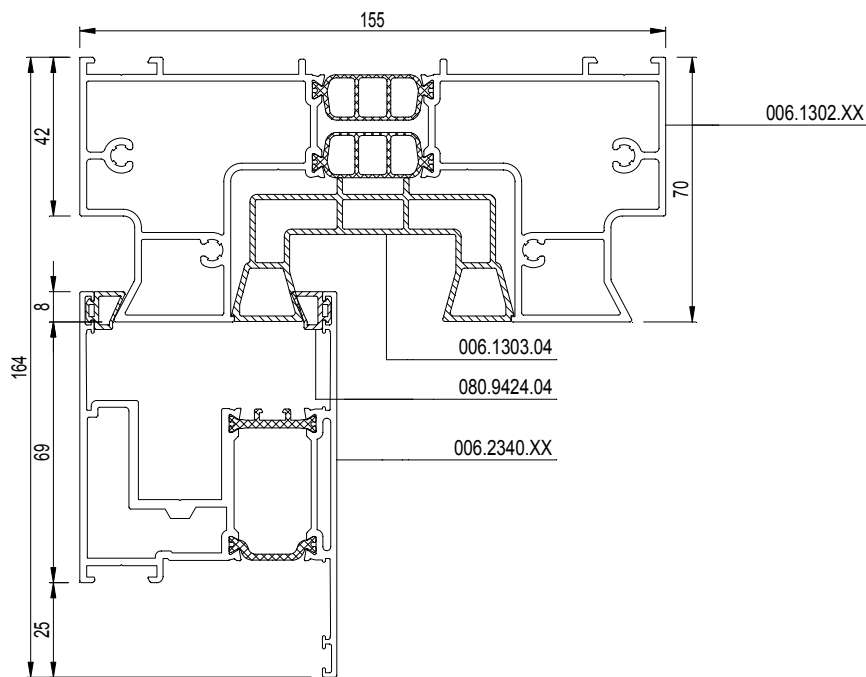
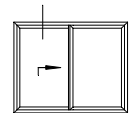
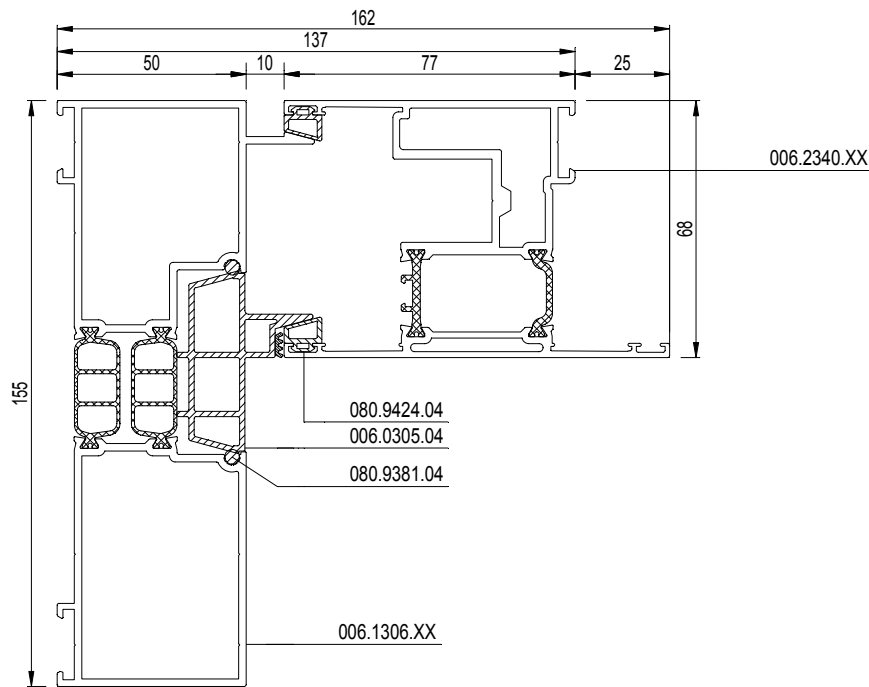
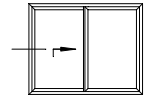

VARIANT HI
 VARIANTE HI
 VARIANT HI
 VARIANT HI

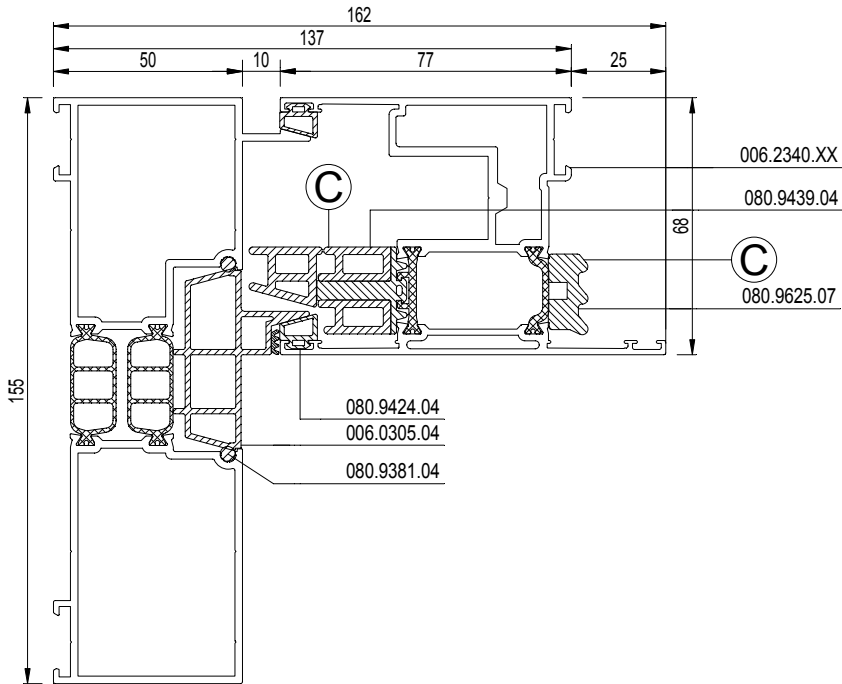
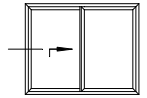

VARIANT HI
 VARIANTE HI
 VARIANT HI
 VARIANT HI

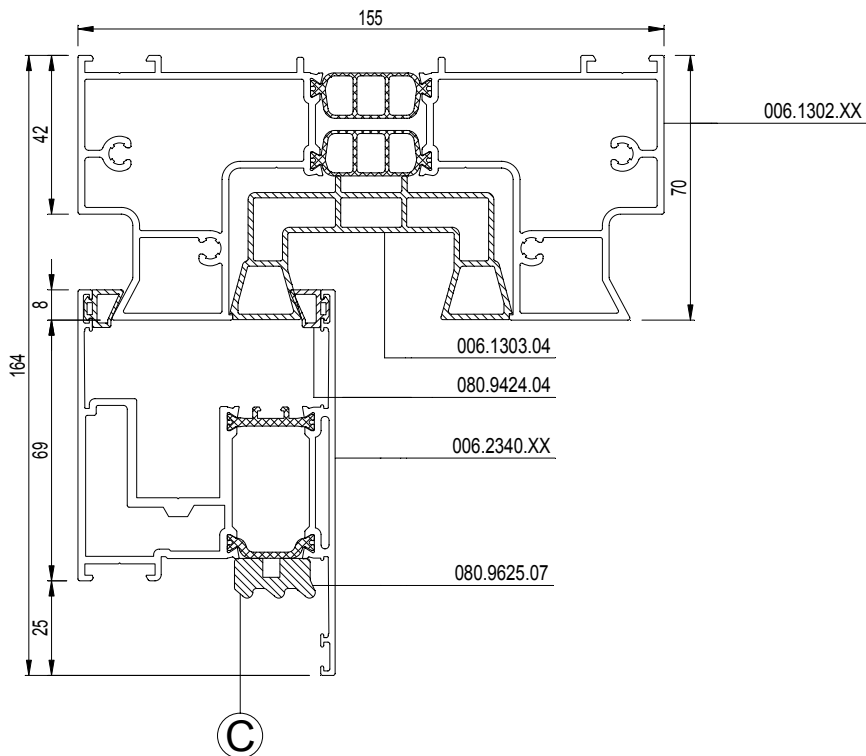
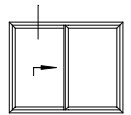

schaal - échelle
 scale - Maßstab
 1/2

D0078785

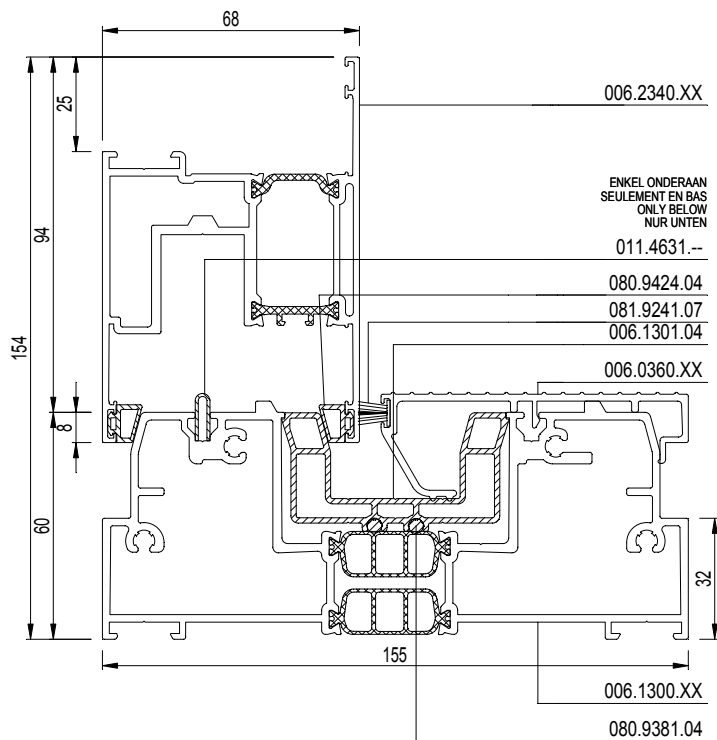
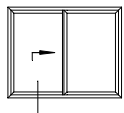
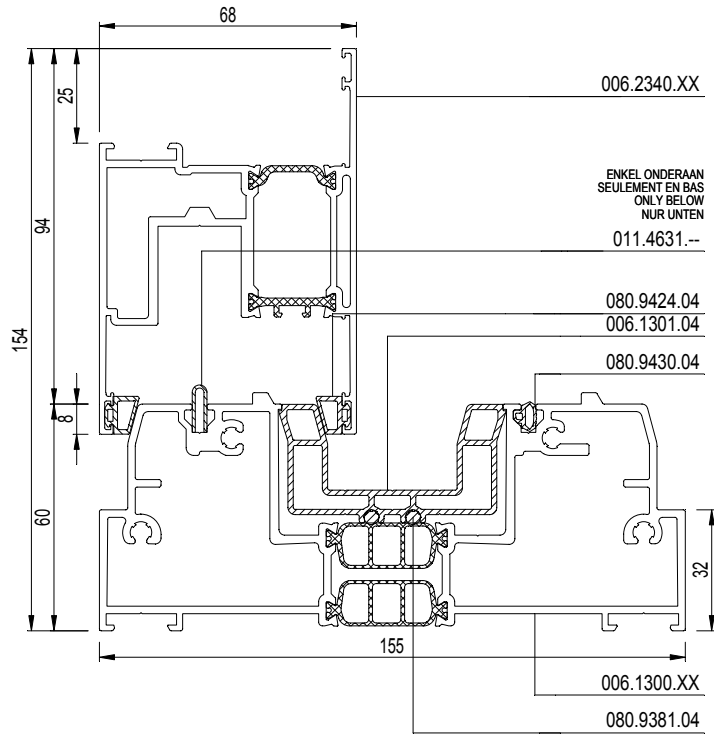
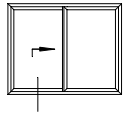

schaal - échelle
 scale - Maßstab
 1/2
 D0078786

VARIANT HI
 VARIANTE HI
 VARIANT HI
 VARIANT HI

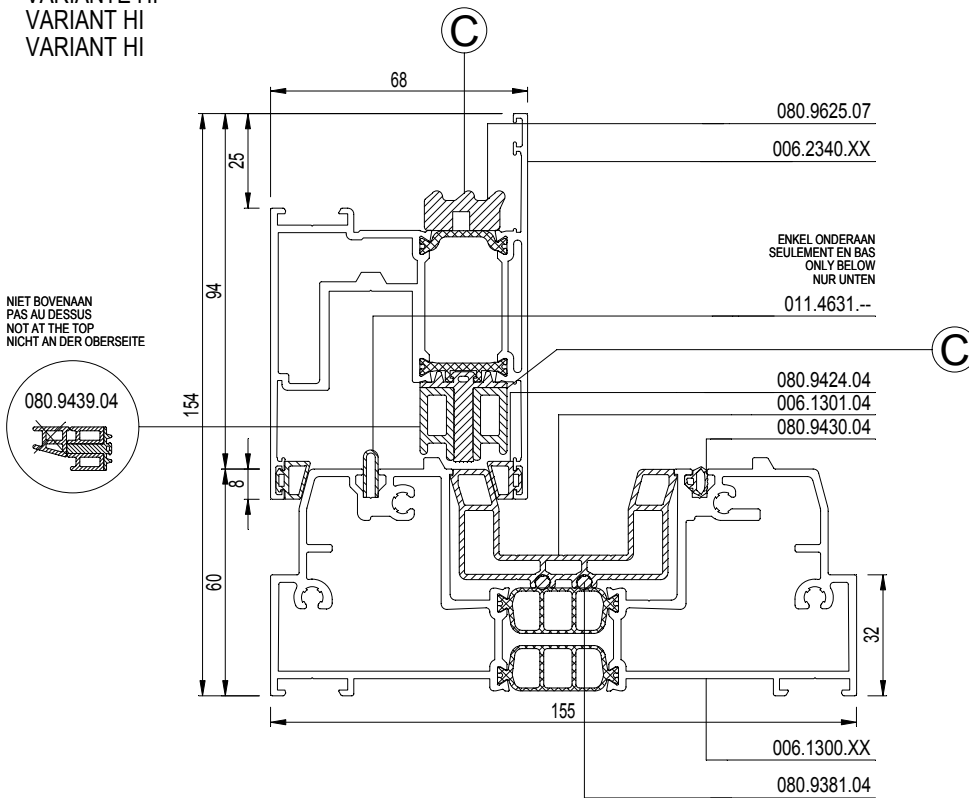
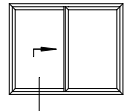

VARIANT HI
 VARIANTE HI
 VARIANT HI
 VARIANT HI

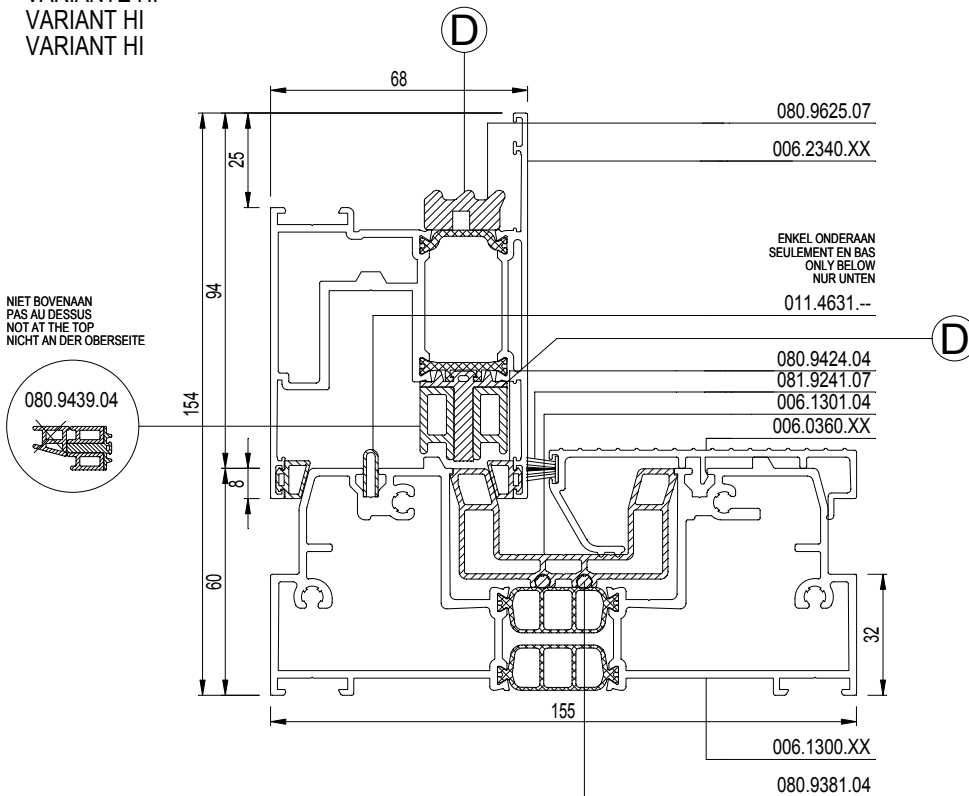
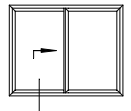

schaal - échelle
 scale - Maßstab
 1/2

D0078786

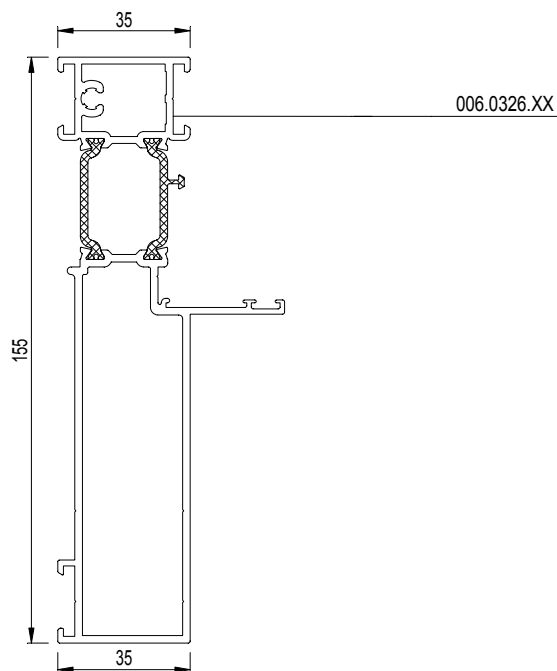
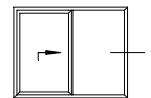
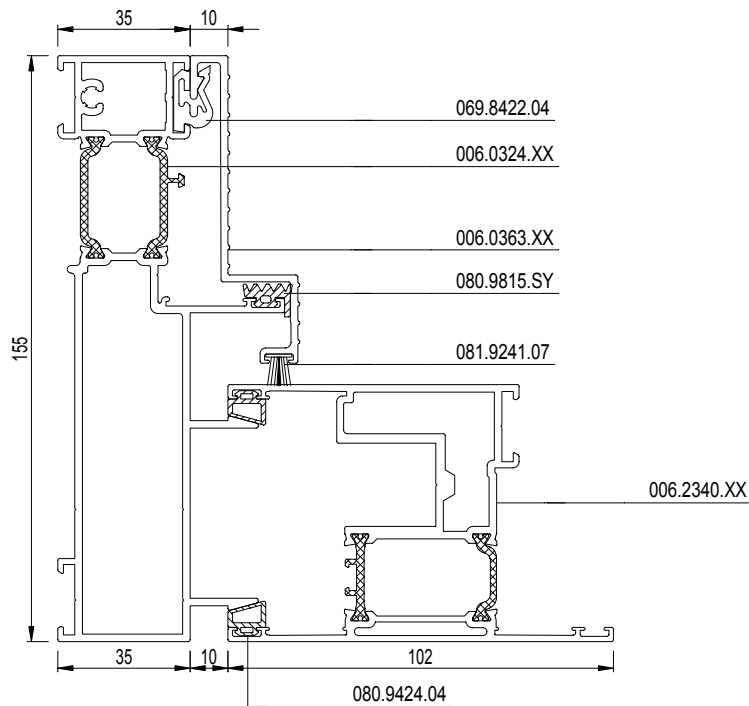
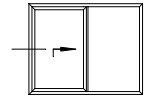

VARIANT HI
 VARIANTE HI
 VARIANT HI
 VARIANT HI

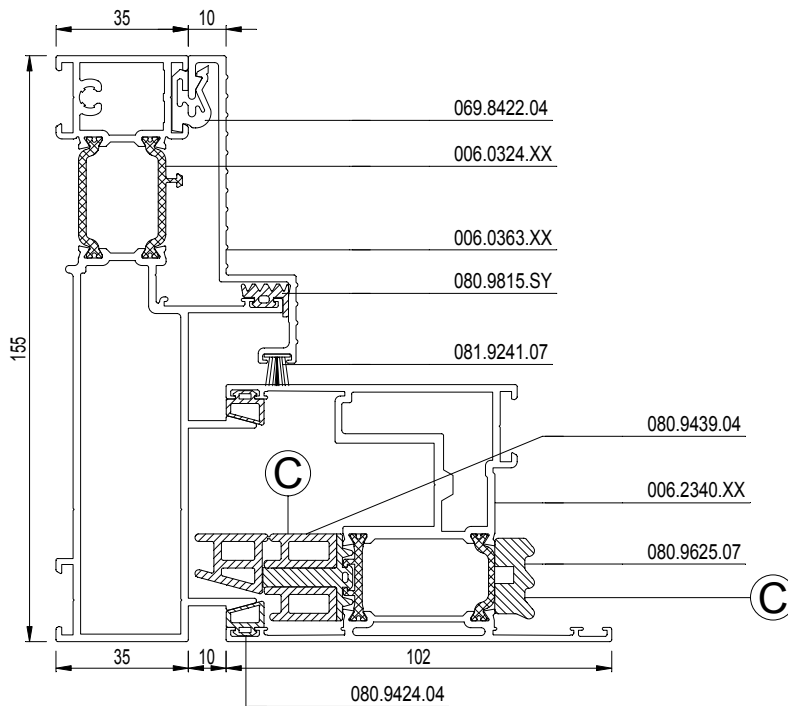
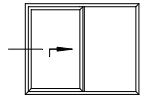

VARIANT HI
 VARIANTE HI
 VARIANT HI
 VARIANT HI

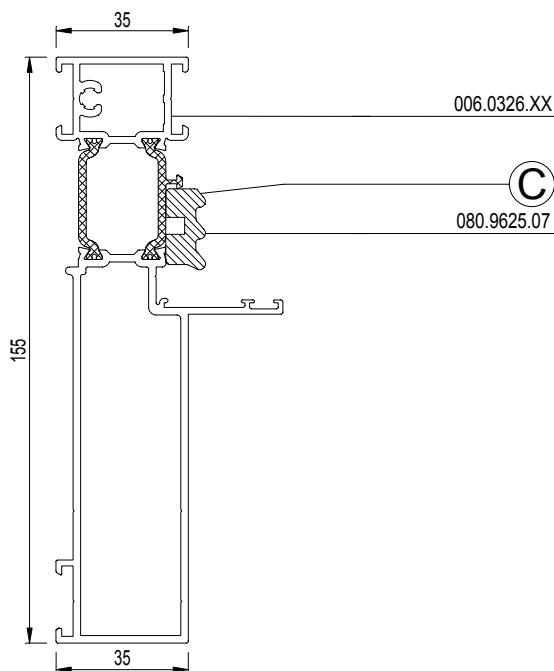
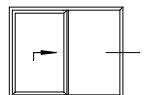

schaal - échelle
 scale - Maßstab
 1/2

D0083931

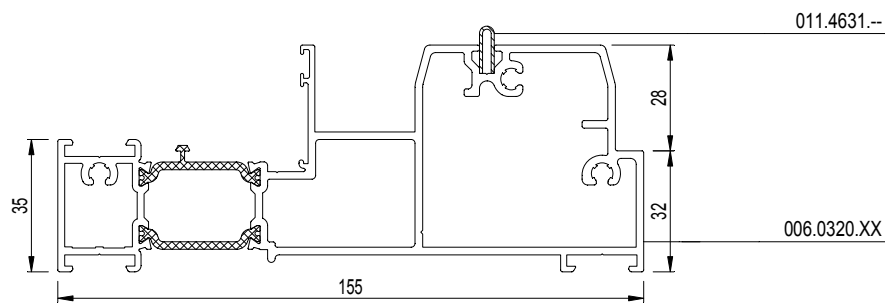
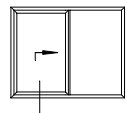
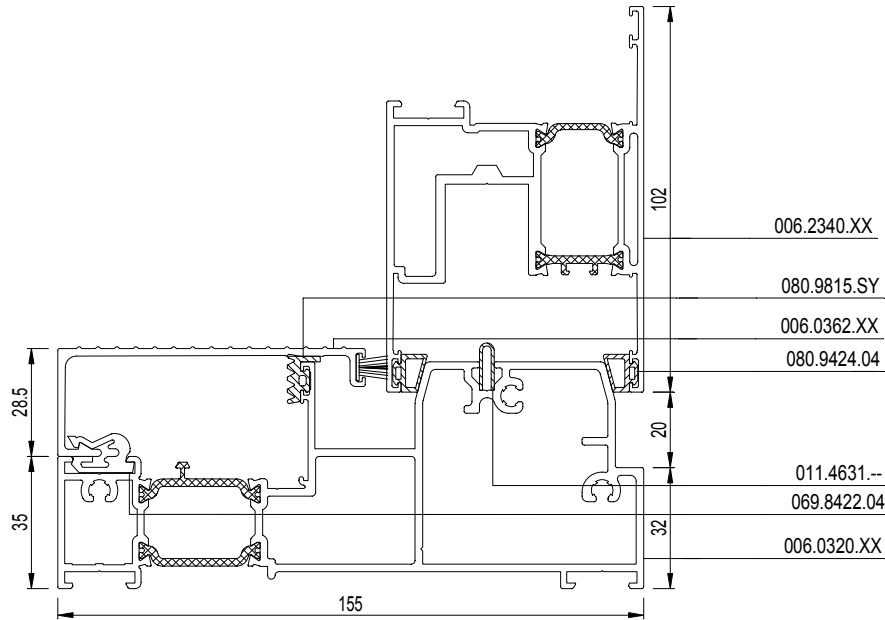
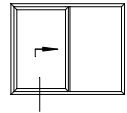

VARIANT HI
 VARIANTE HI
 VARIANT HI
 VARIANT HI

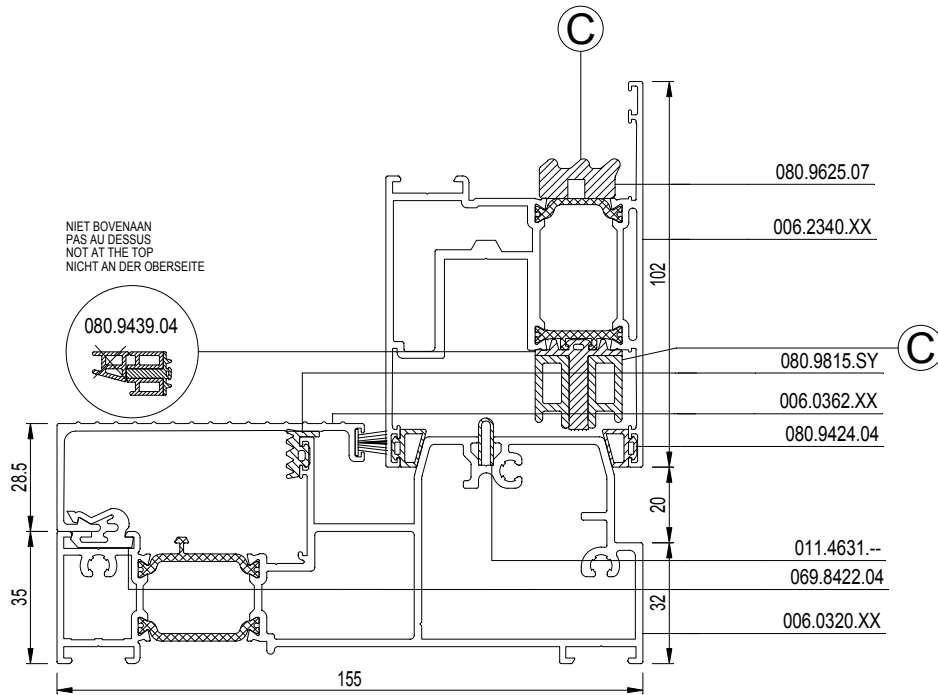
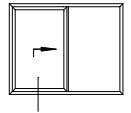

VARIANT HI
 VARIANTE HI
 VARIANT HI
 VARIANT HI

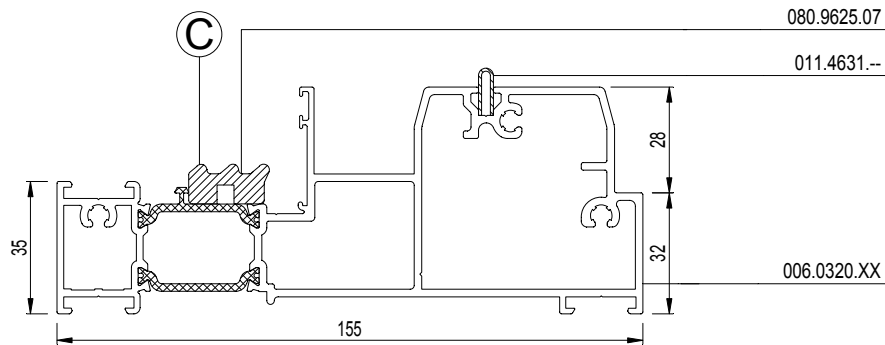
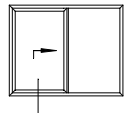

schaal - échelle
 scale - Maßstab
 1/2

D0090017

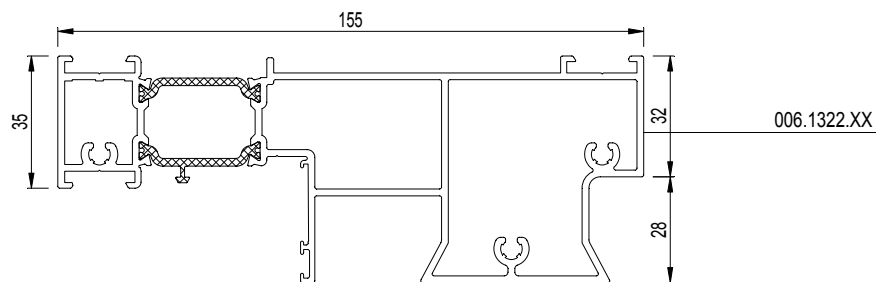
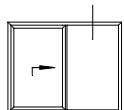
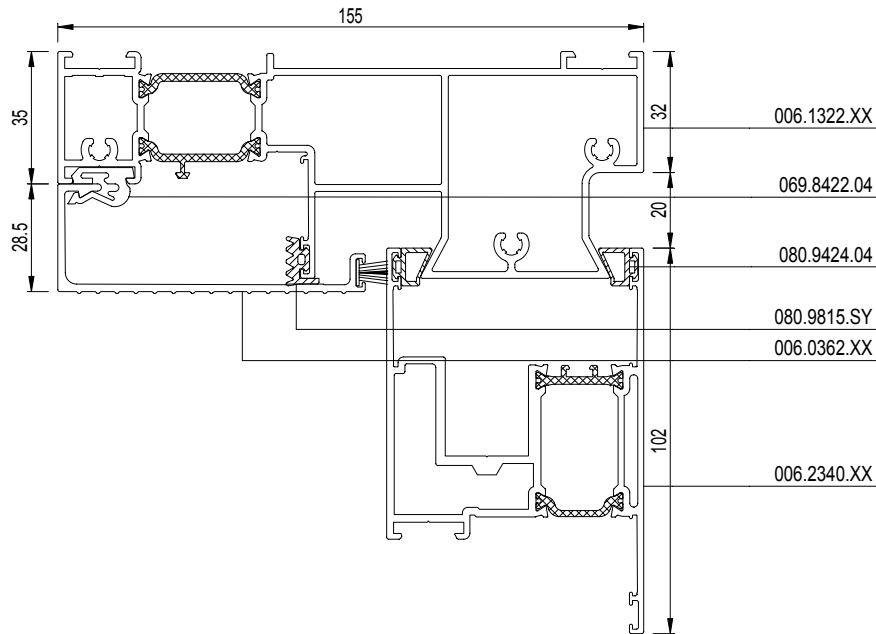
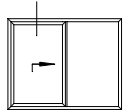

VARIANT HI
 VARIANTE HI
 VARIANT HI
 VARIANT HI

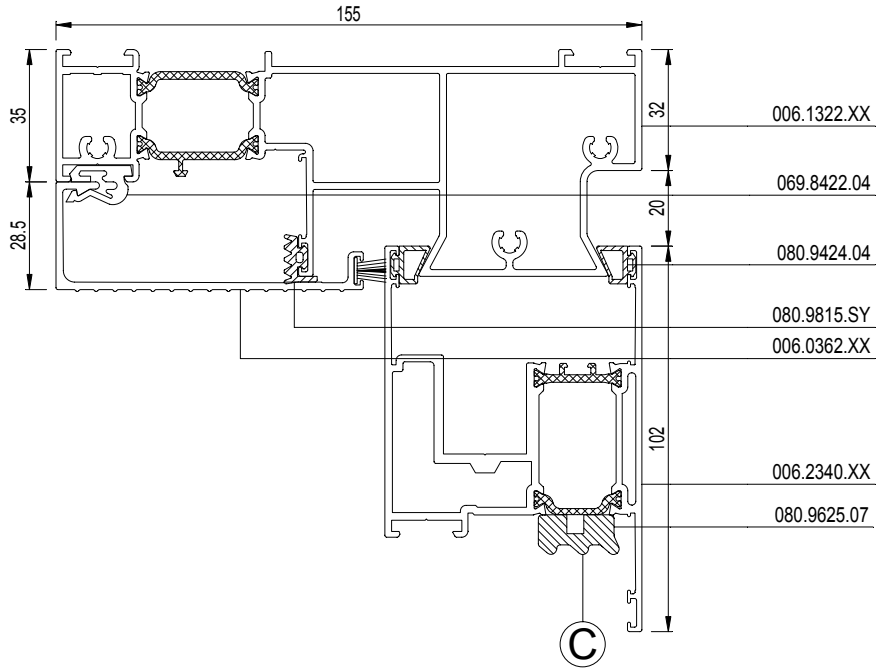
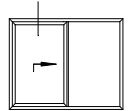

VARIANT HI
 VARIANTE HI
 VARIANT HI
 VARIANT HI

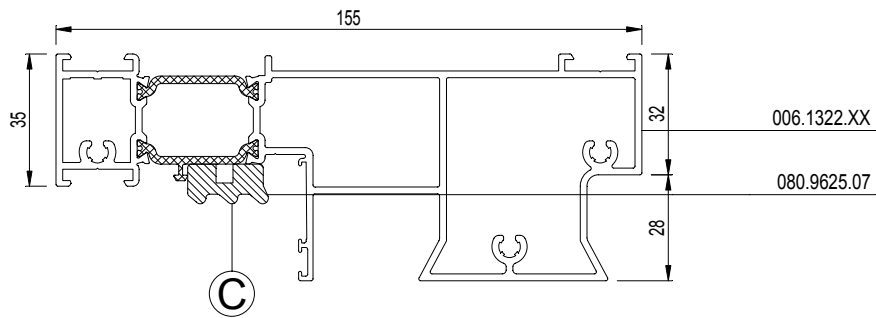
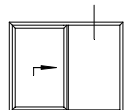

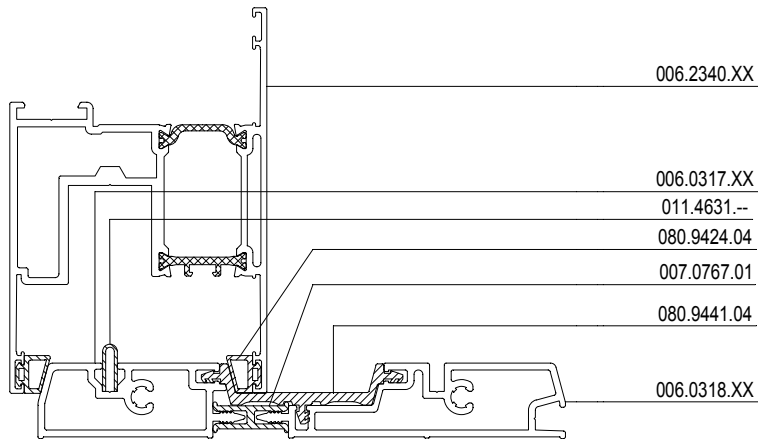
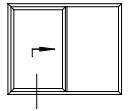

VARIANT HI
 VARIANTE HI
 VARIANT HI
 VARIANT HI

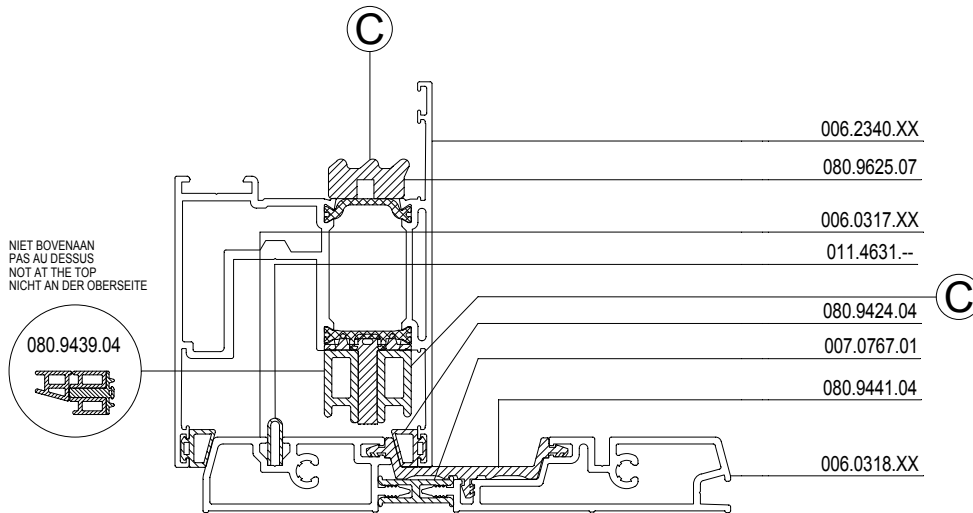
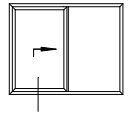

CP 155 CP 155-LS

OVERZICHT ISOLATIE VARIANTEN
APERCU VARIANTES D'ISOLATION
OVERVIEW INSULATION VARIANTS
UEBERSICHT ISOLIERVARIANTEN

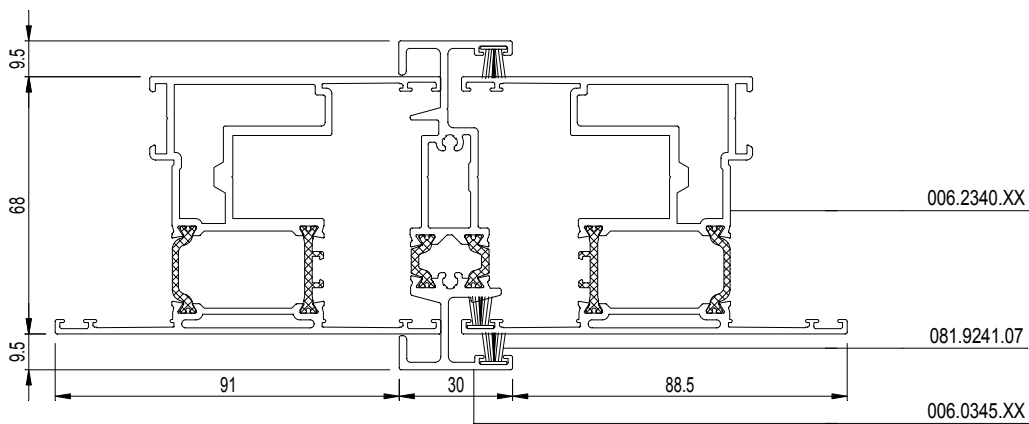
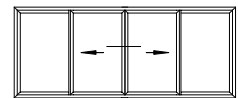
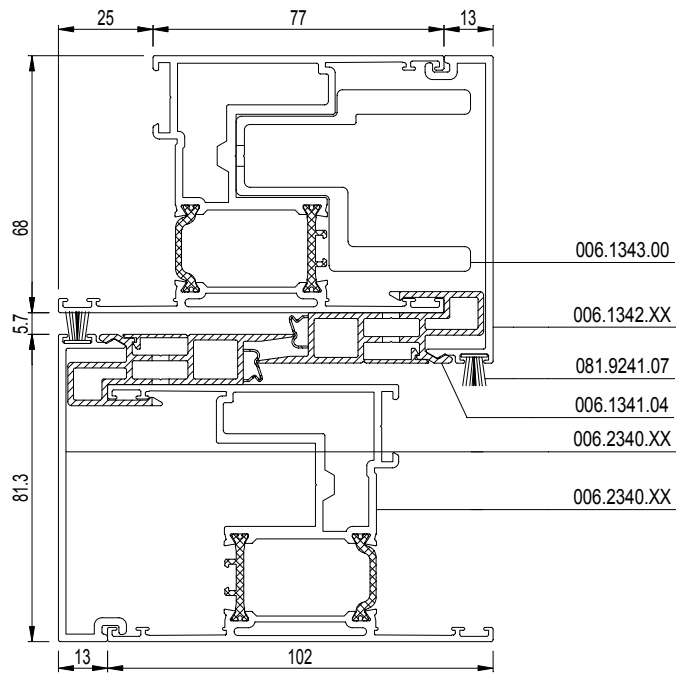
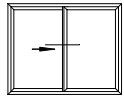

schaal - échelle
scale - Maßstab
1/2
D0090111

CP 155-HI CP 155-LS/HI

OVERZICHT ISOLATIE VARIANTEN
APERCU VARIANTES D'ISOLATION
OVERVIEW INSULATION VARIANTS
UEBERSICHT ISOLIERVARIANTEN



VARIANT HI
VARIANTE HI
VARIANT HI
VARIANT HI

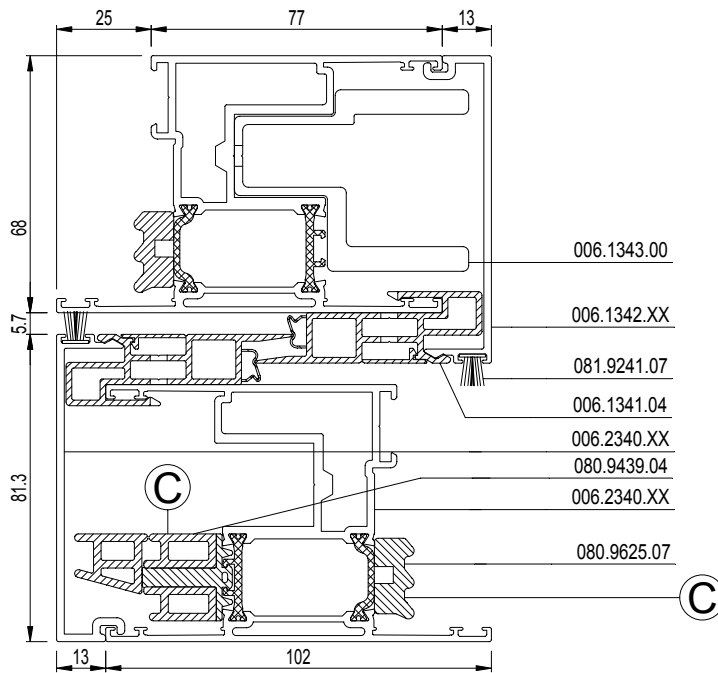
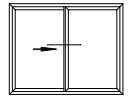

VARIANT HI
VARIANTE HI
VARIANT HI
VARIANT HI

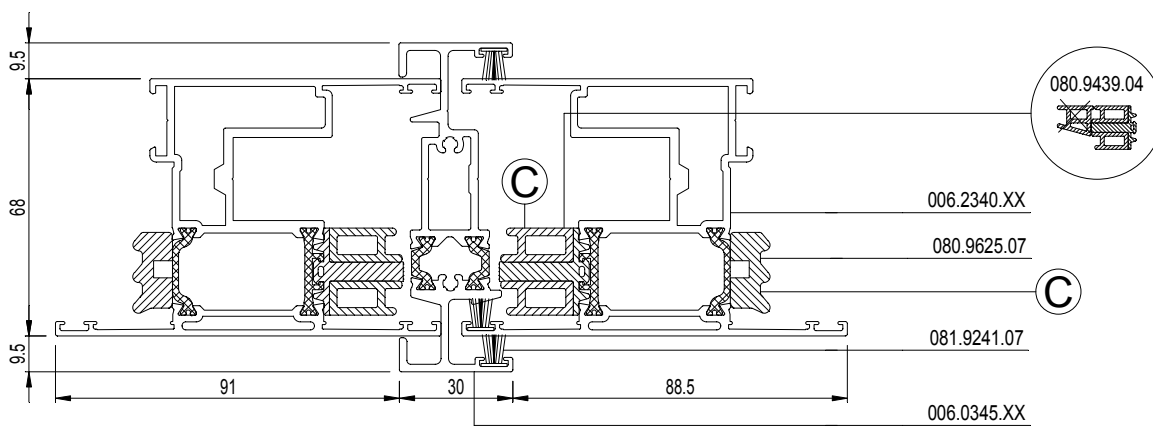
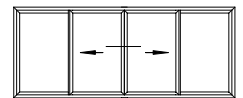

schaal - échelle
scale - Maßstab
1/2

D0090111

CP 155-LS/HI MINERGIE LABEL

OVERZICHT ISOLATIE VARIANTEN MONORAIL MINERGIE LABEL
 APERCU VARIANTES D'ISOLATION MONORAIL MINERGIE LABEL
 OVERVIEW INSULATION VARIANTS MONORAIL MINERGIE LABEL
 UEBERSICHT ISOLIERVARIANTEN MONORAIL MINERGIE LABEL

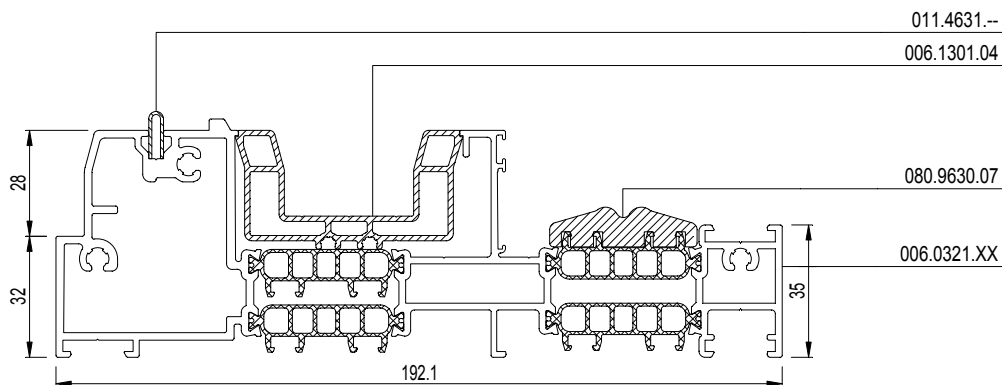
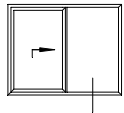
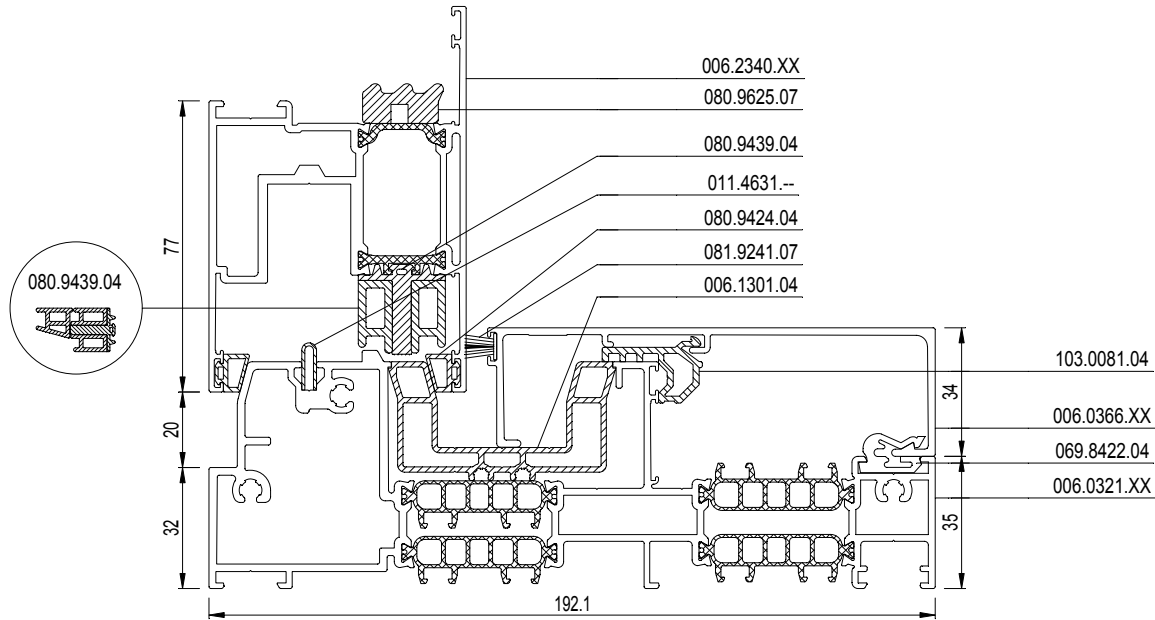
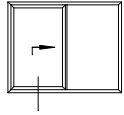

schaal - échelle
scale - Maßstab
1/2
D0083932

CP 155-LS/HI MINERGIE LABEL

OVERZICHT ISOLATIE VARIANTEN MONORAIL MINERGIE LABEL
 APERCU VARIANTES D'ISOLATION MONORAIL MINERGIE LABEL
 OVERVIEW INSULATION VARIANTS MONORAIL MINERGIE LABEL
 UEBERSICHT ISOLIERVARIANTEN MONORAIL MINERGIE LABEL

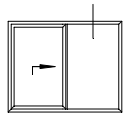
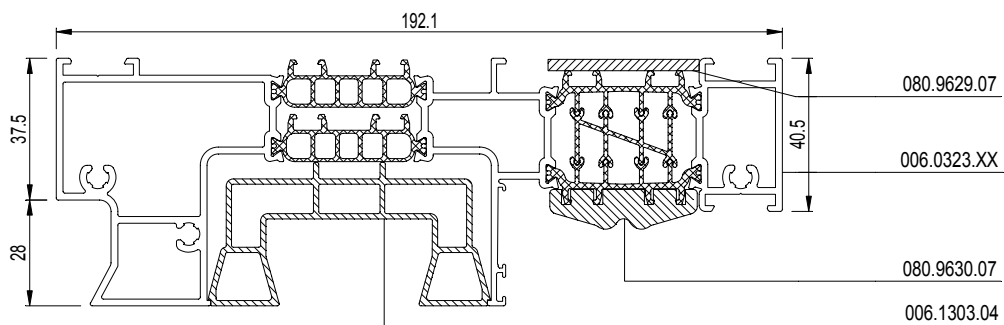
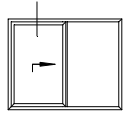
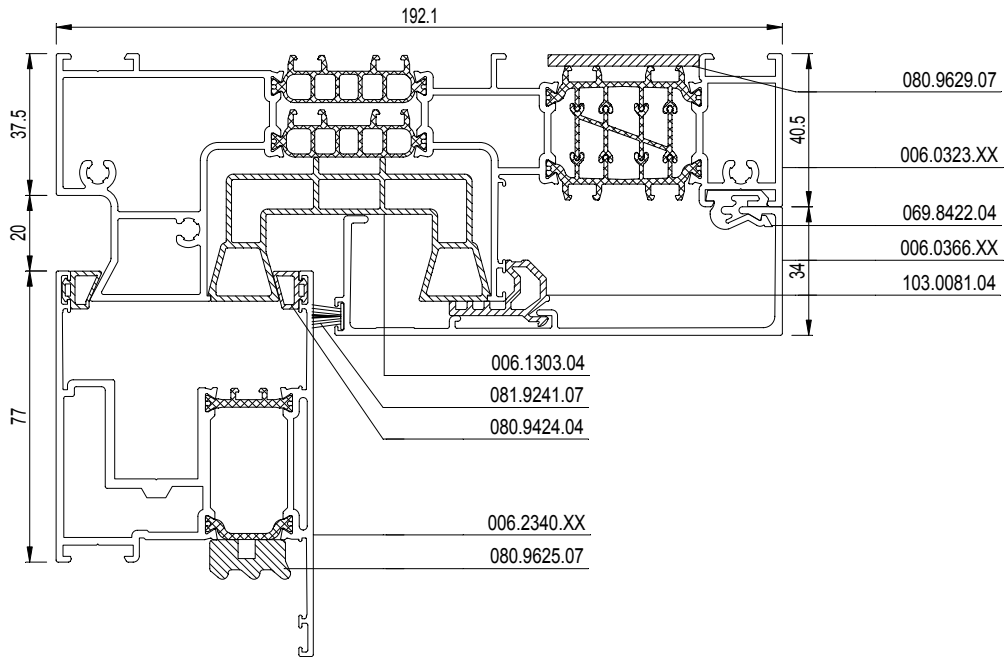

schaal - échelle
 scale - Maßstab
 1/2

D00083932

CP 155-LS/Hi MINERGIE LABEL

OVERZICHT ISOLATIE VARIANTEN MONORAIL MINERGIE LABEL
 APERCU VARIANTES D'ISOLATION MONORAIL MINERGIE LABEL
 OVERVIEW INSULATION VARIANTS MONORAIL MINERGIE LABEL
 UEBERSICHT ISOLIERVARIANTEN MONORAIL MINERGIE LABEL

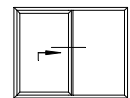
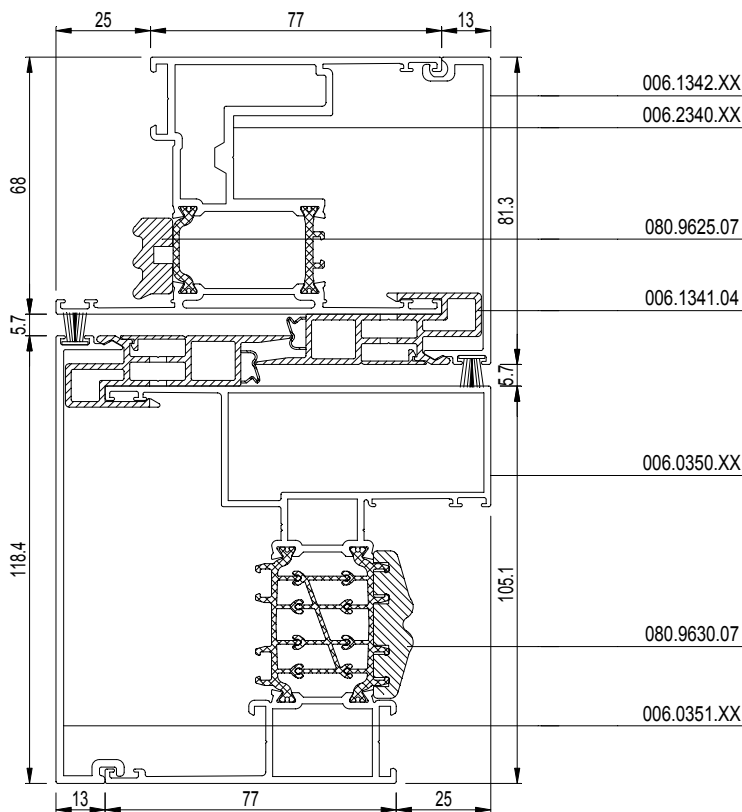
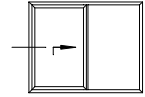
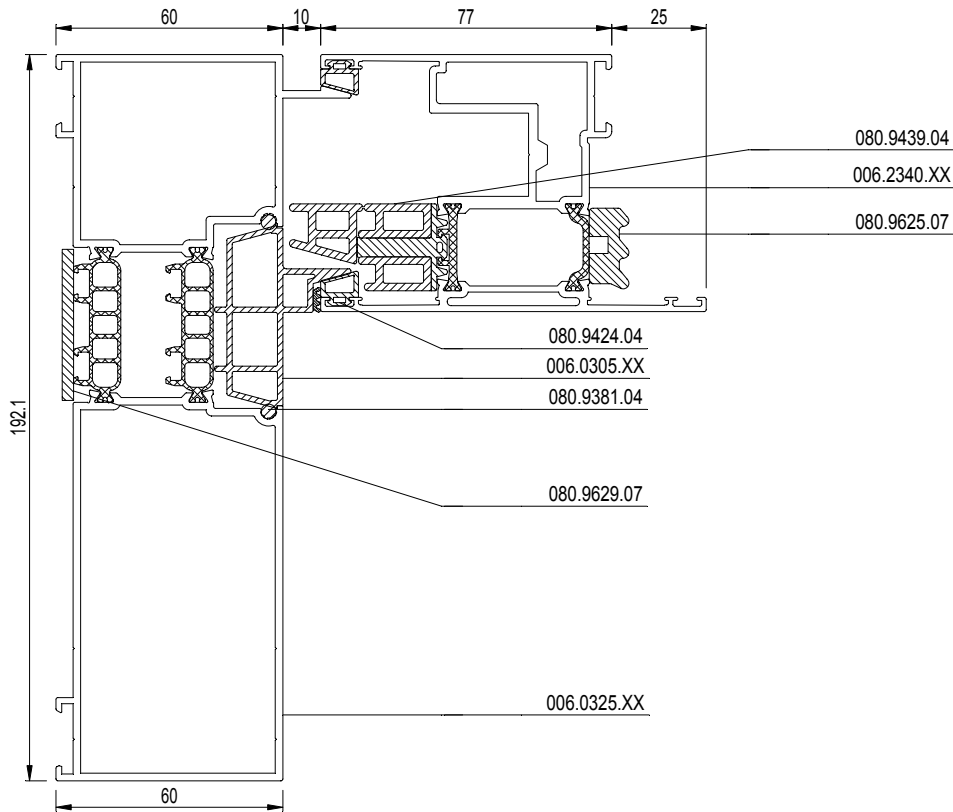

schaal - échelle
 scale - Maßstab
 1/2
 D0090335

CP 155-LS/HI MINERGIE LABEL

OVERZICHT ISOLATIE VARIANTEN MONORAIL MINERGIE LABEL
 APERCU VARIANTES D'ISOLATION MONORAIL MINERGIE LABEL
 OVERVIEW INSULATION VARIANTS MONORAIL MINERGIE LABEL
 UEBERSICHT ISOLIERVARIANTEN MONORAIL MINERGIE LABEL

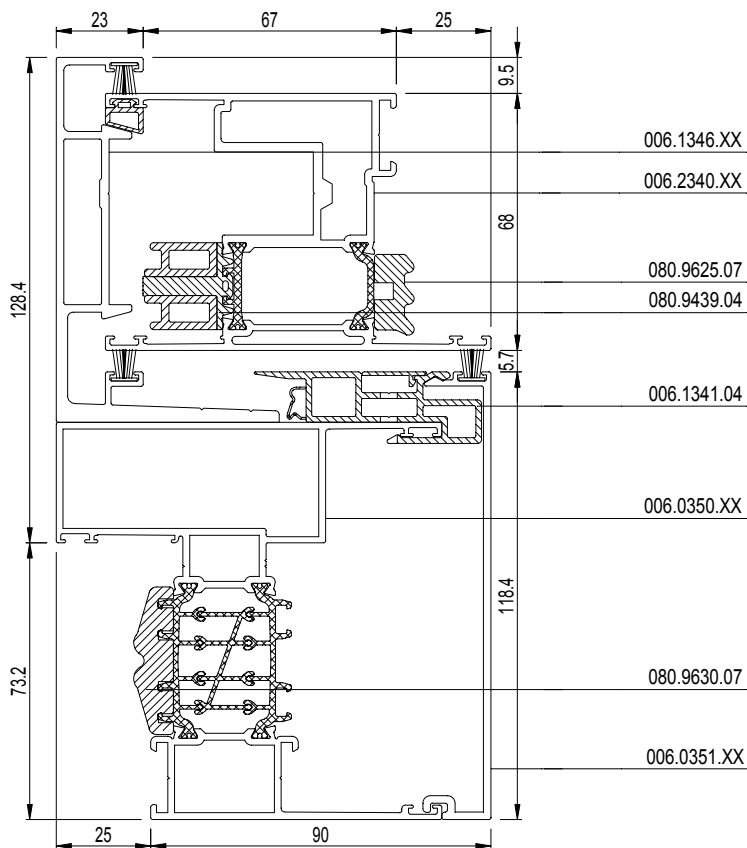
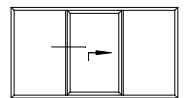
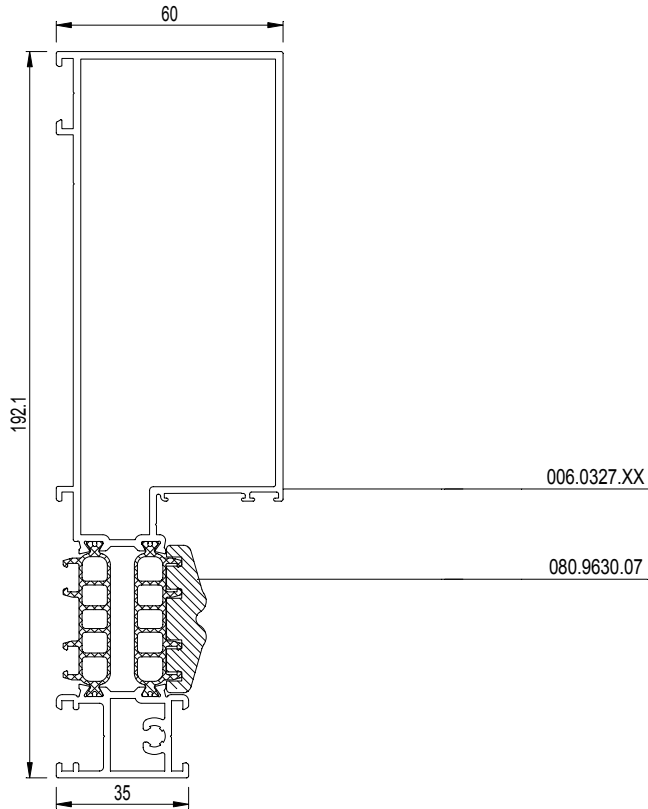
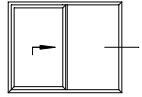

schaal - échelle
 scale - Maßstab
 1/2

D0090335

2-RAIL
2-RAIL

2-RAIL
2-RAIL

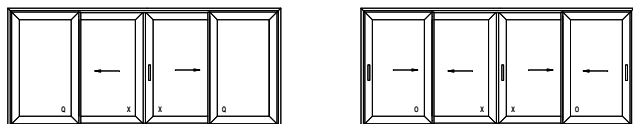
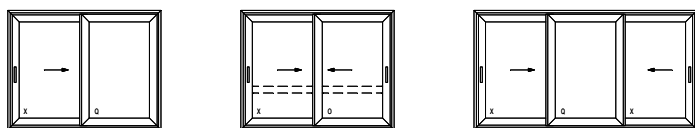

MONORAIL
MONORAIL

MONORAIL
MONORAIL

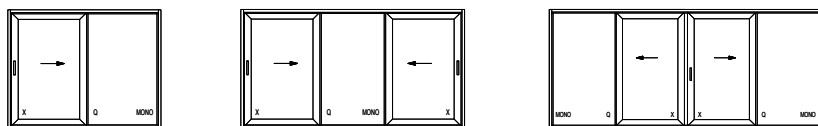

3-RAIL
3-RAIL

3-RAIL
3-RAIL



X : PRIMAIRE VLEUGEL
Q : VASTE VLEUGEL
O : SECUNDAIRE VLEUGEL

X : OUVRANT PRIMAIRE
Q : OUVRANT FIXE
O : OUVRANT SECUNDAIRE

X : PRIMARY SLIDING VENT
Q : FIXED VENT
O : SECONDARY SLIDING VENT

X : GANGFLUEGEL
Q : FESTER FLUEGEL
O : STANDFLUEGEL

	2-RAIL 2-RAIL	2-RAIL 2-RAIL
--	------------------	------------------

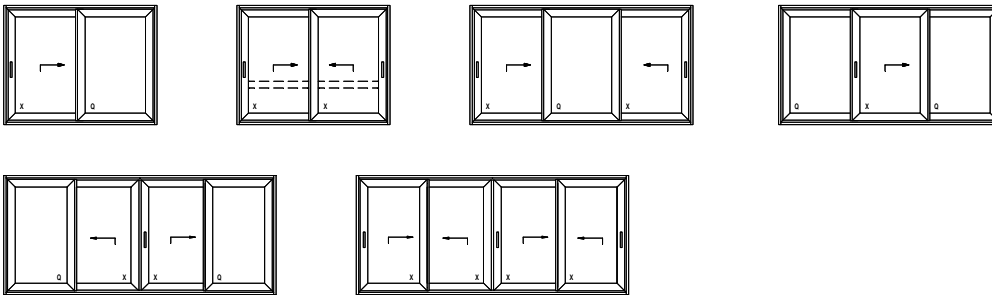

	2-RAIL FLAT BOTTOM 2-RAIL FLAT BOTTOM	2-RAIL FLAT BOTTOM 2-RAIL FLAT BOTTOM
--	--	--

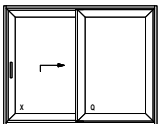

	MONORAIL MONORAIL	MONORAIL MONORAIL
--	----------------------	----------------------

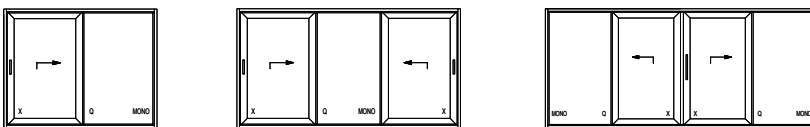

	3-RAIL 3-RAIL	3-RAIL 3-RAIL
--	------------------	------------------

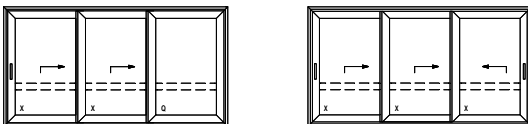

	AUTOMATISCHE HEFSCHUIFDEUR SOULEV.COULISSANT AUTOMATIQUE	AUTOMATIC LIFT AND SLIDING DOOR AUTOMATISCHE HEBESCHIEBETUER
--	---	---

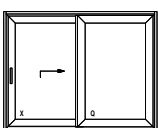

CP 155-AP CP 155-LS/AP

OVERZICHT
APERCU
OVERVIEW
UEBERSICHT



2-RAIL
2-RAIL

2-RAIL
2-RAIL

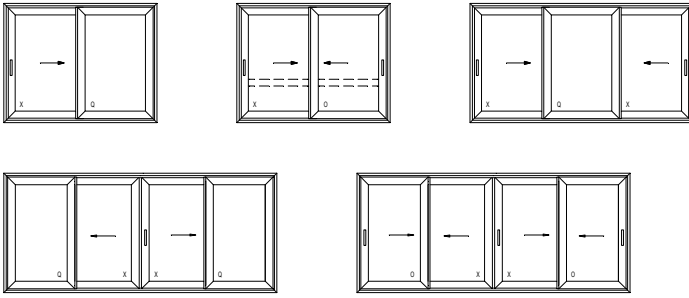

2-RAIL
2-RAIL

2-RAIL
2-RAIL

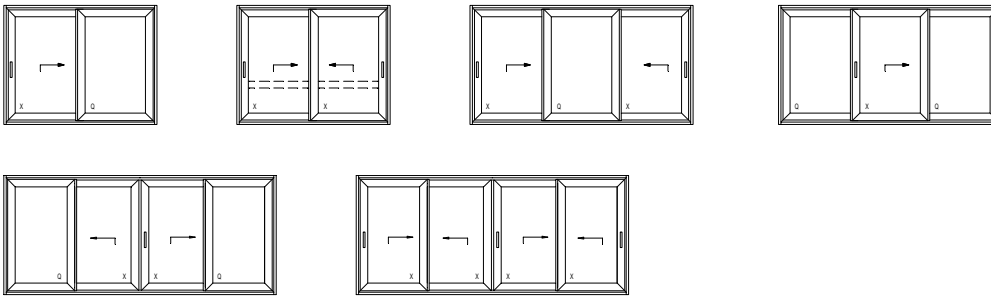

schaal - échelle
scale - Maßstab
1/2
D0084659

CP 155-LS/HI MINERGIE LABEL

OVERZICHT
APERCU
OVERVIEW
UEBERSICHT



	MONORAIL MONORAIL	MONORAIL MONORAIL
--	----------------------	----------------------

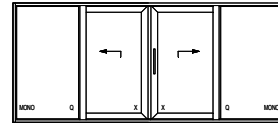
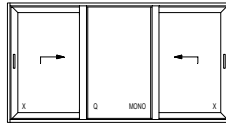
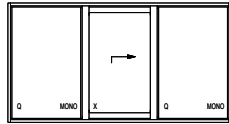
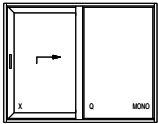

X : PRIMAIRE VLEUGEL
Q : VASTE VLEUGEL
O : SECONDAIRE VLEUGEL

X : OUVRANT PRIMAIRE
Q : OUVRANT FIXE
O : OUVRANT SECONDAIRE

X : PRIMARY SLIDING VENT
Q : FIXED VENT
O : SECONDARY SLIDING VENT

X : GANGFLUEGEL
Q : FESTER FLUEGEL
O : STANDFLUEGEL

schaal - échelle
scale - Maßstab
1/2

D0084639

VLEUGELGEWICHT POIDS DU VANTAIL WEIGHT OF THE VENT FLUEGELGEWICHT	MAX. 250KG
--	------------

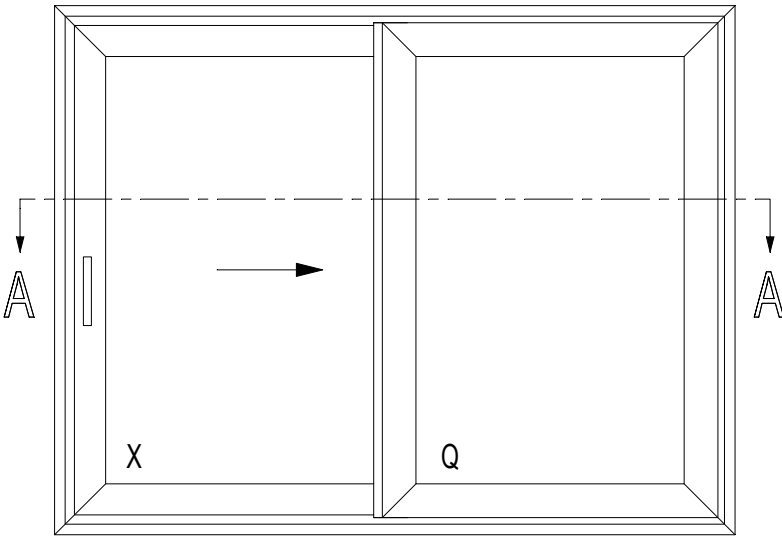

A - A

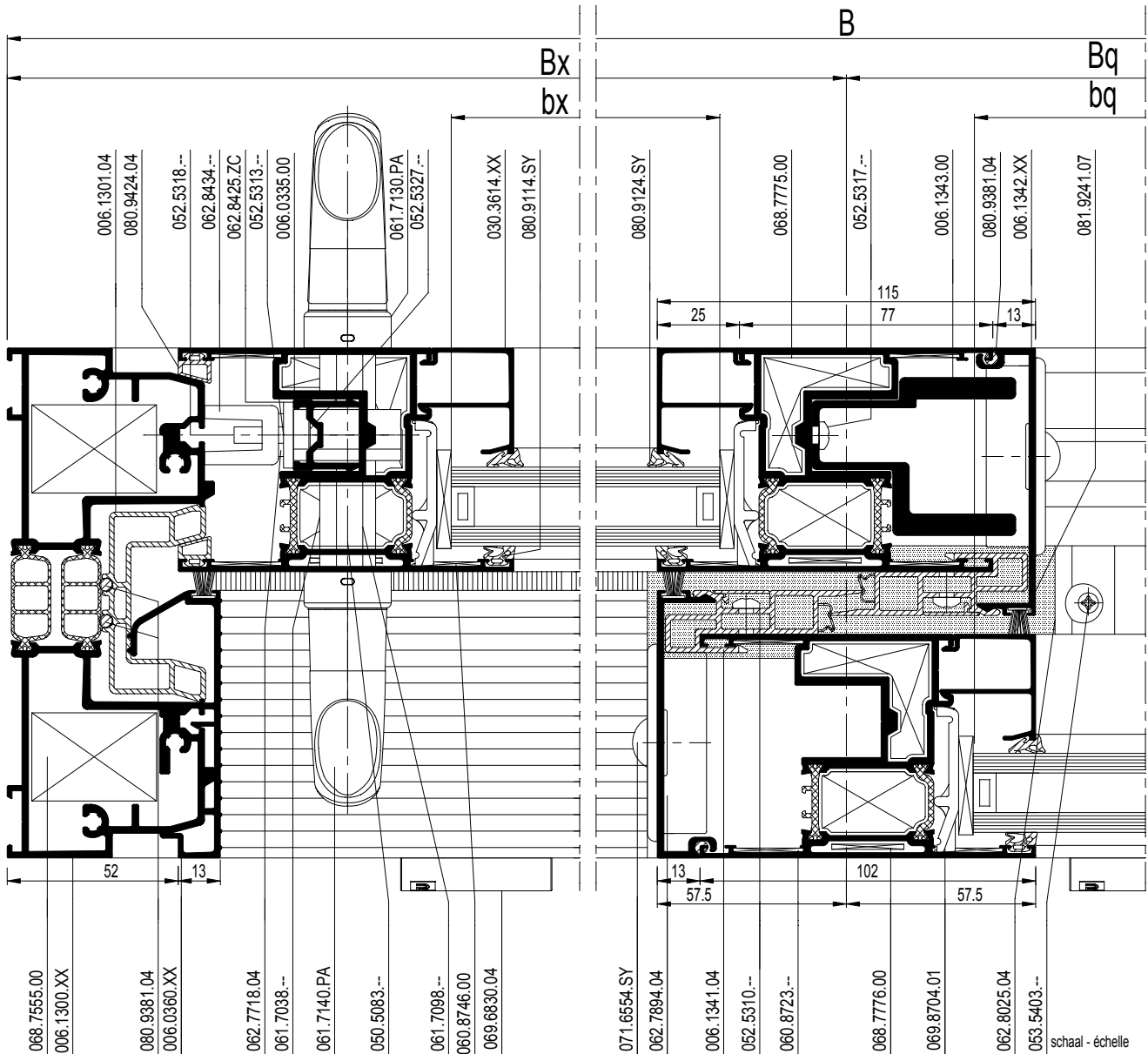

068.7555.00
 006.1300.XX
 080.9381.04
 006.0360.XX
 062.7718.04
 061.7038.--
 061.7140.PA
 050.5083.--
 061.7098.--
 060.8746.00
 069.6830.04

071.6554.SY
 062.7894.04
 006.1341.04
 052.5310.--
 060.8723.--
 068.7776.00
 069.8704.01
 062.8025.04
 053.5403.--

schaal - échelle
 Maßstab - scale
 1/2

D0013911

X : PRIMAIRE VLEUGEL
 Q : VASTE VLEUGEL
 O : SECUNDAIRE VLEUGEL

X : OUVRANT PRIMAIRE
 Q : OUVRANT FIXE
 O : OUVRANT SECONDAIRE

X : PRIMARY SLIDING VENT
 Q : FIXED VENT
 O : SECONDARY SLIDING VENT

X : GANGFLUGEL
 Q : FESTE FLUGEL
 O : STANDFLUGEL

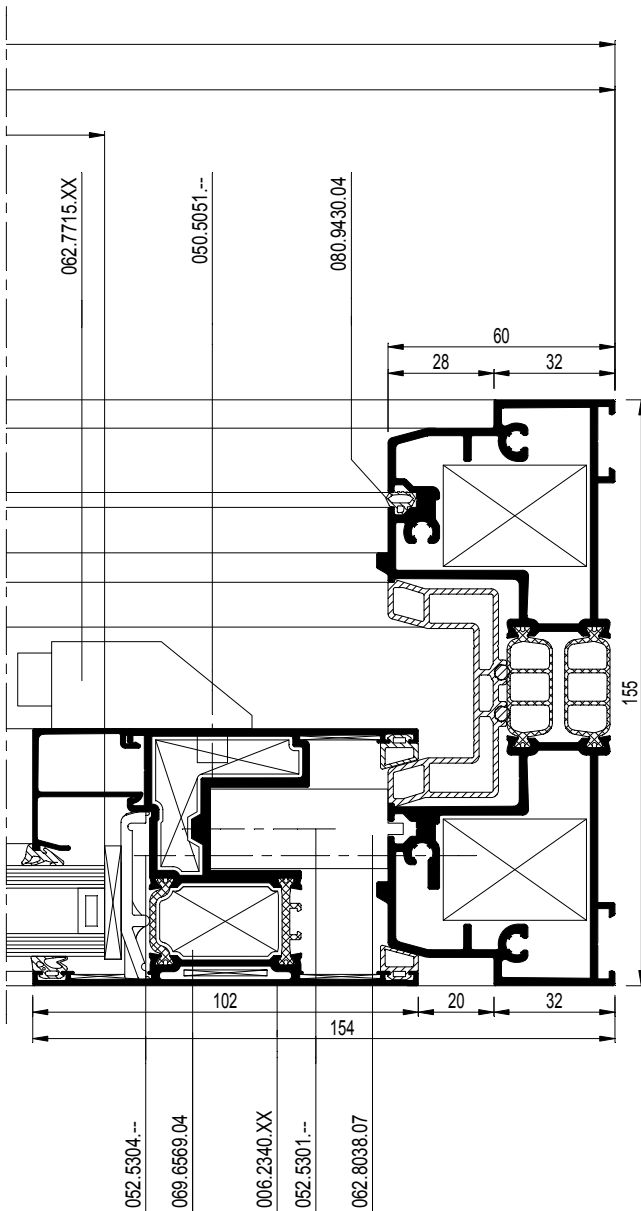

schaal - échelle
 Maßstab - scale
 1/2

D0013911

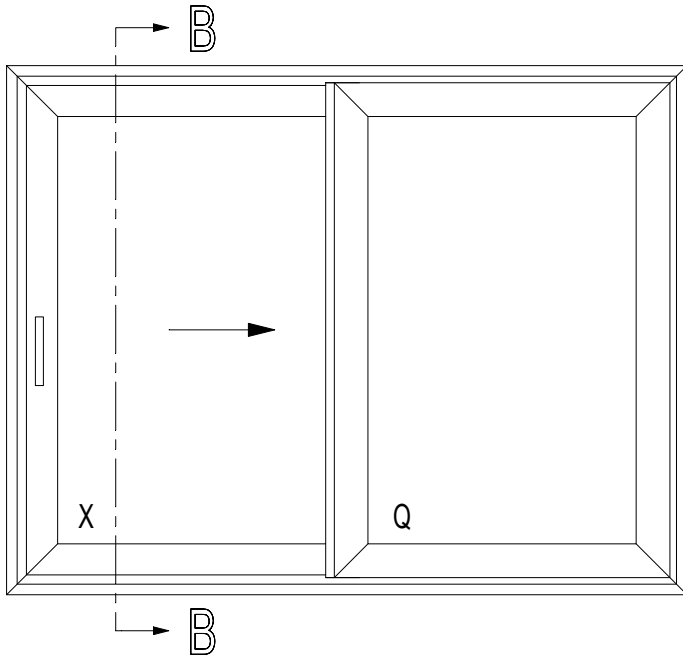

			#	L_m	
006.1300.XX 006.1301.04			2	B	34.C. ...
011.4631.--			1	B-116	34.C. ...
006.2340.XX			2	Bx-7.5	34.C. ...
			2	Bq-7.5	
			4	H-104	
006.1342.XX			2	H-104	34.C. ...
006.1341.04			2	H-104	34.C. ...
006.1343.00			1	H-162	34.C. ...
006.0335.00			1	280MM	34.C. ...
				(062.8425.ZC)	
			1	H-214	
				(062.8426.ZC)	
030.3614.XX			2	Bx-161.5	34.C. ...
			2	Bq-161.5	
			4	H-308	
006.0360.XX			1	Bx-97	34.C. ...
			1	Bx-97	
			1	H-75.6	

VARIANT HI

080.9439.04		(1xB)+(3xH)	34.G. ...
080.9625.07		(2xB)+(4xH)	34.G. ...

(*)

		#	
068.7555.00		8	34.G. ...
068.7775.00		8	34.G. ...
069.6569.04		8	34.G. ...
068.7776.00		8	34.G. ...
060.8723.--		16	34.G. ...
060.8746.00		8	34.G. ...
062.7894.04		2	34.G. ...
052.5317.--		4	34.G. ...
071.6554.SY		4	34.G. ...
062.7927.04		min. 8	34.G. ...
062.8425.ZC		1	34.G. ...
052.5313.--		2	34.G. ...
062.8434.--		1	34.G. ...
052.5318.--		3	34.G. ...
052.5327.--		2	34.G. ...
062.8426.ZC		1	34.G. ...
052.5313.--		13	34.G. ...
062.8440.--		1	34.G. ...
052.5318.--		12	34.G. ...
052.5327.--		6	34.G. ...
062.7718.04		1	34.G. ...
061.7130.PA		1	34.G. ...
050.5083.--		3	34.G. ...
061.7140.PA		1	34.G. ...
061.7038.--		1	34.G. ...
061.7098.--		1	34.G. ...
062.7715.XX		1	34.G. ...
050.5051.--		1	34.G. ...
062.7834.--		2	34.G. ...
052.5372.--		4	34.G. ...
062.8038.07		6	34.G. ...
052.5301.--		6	34.G. ...
052.5304.--		6	34.G. ...
062.8025.04		1	34.G. ...
053.5403.--		4	34.G. ...
052.5310.--		2xH (3/m)	34.G. ...
052.5317.--		H (3/m)	34.G. ...
069.8704.01		16	34.G. ...
062.6857.04		1	34.G. ...
069.6830.04		min. 2	34.G. ...
080.9424.04		4xH	34.G. ...
080.9124.SY		(2xB)+(4xH)	34.G. ...
080.9114.SY		(2xB)+(4xH)	34.G. ...
080.9381.04		(4xB)+(6xH)	34.G. ...
081.9241.07		(5xB)+(3xH)	34.G. ...
080.9430.04		1xH	34.G. ...

(*) Afhankelijk van de hoogte
Dépend de l'hauteur
Dependent of the height
Von der Höhe abhängig



VLEUGELGEWICHT POIDS DU VANTAIL WEIGHT OF THE VENT FLUEGELGEWICHT	MAX. 250KG
--	------------

bx = Bx-173.5
hx = H-270
bq = Bq-173.5
hq = H-270

B - B

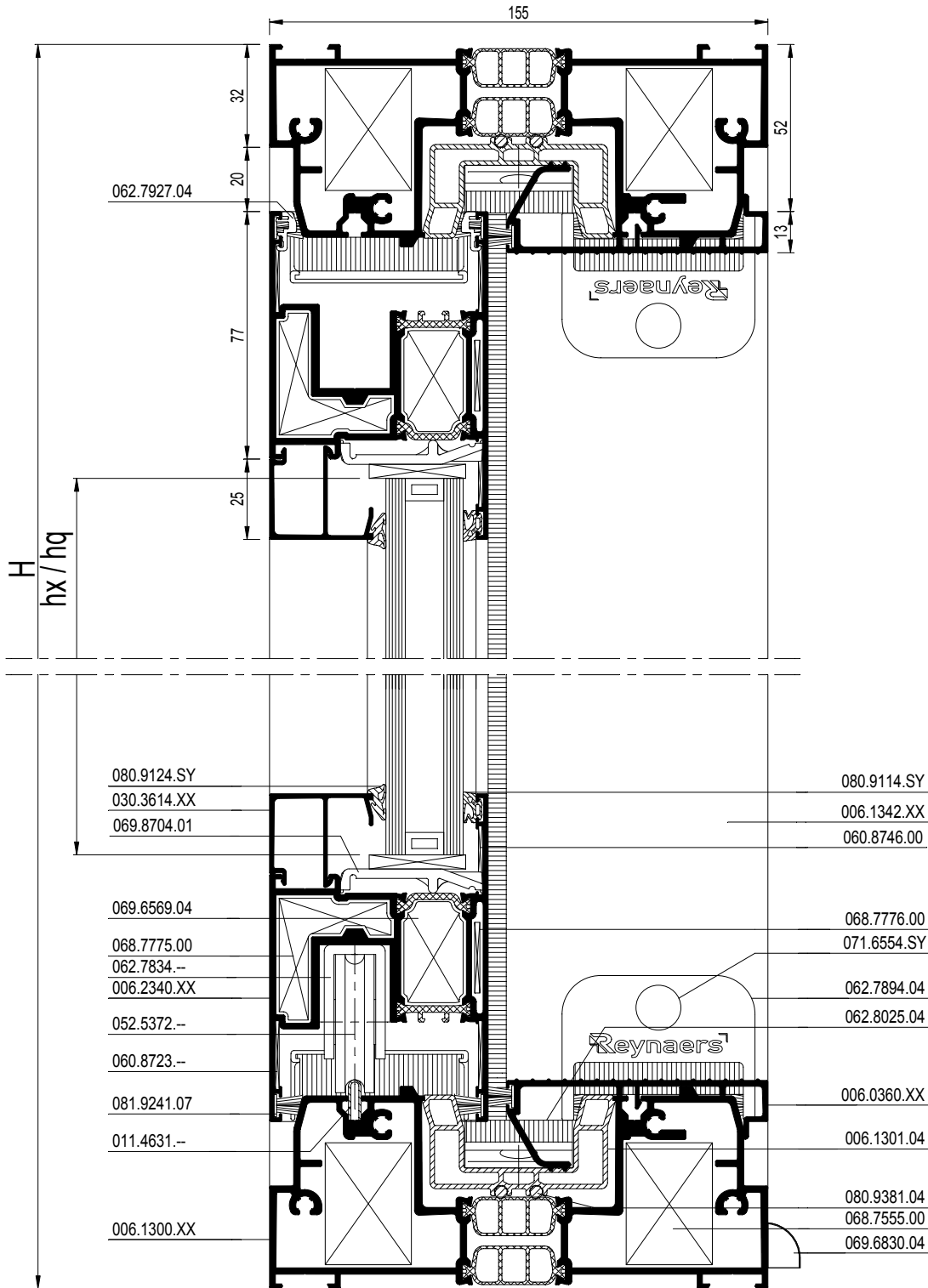

schaal - échelle
 Maßstab - scale
 1/2

D0013912

CP 155

2-RAIL XQ
2-RAIL XQ
2-RAIL XQ
2-RAIL XQ

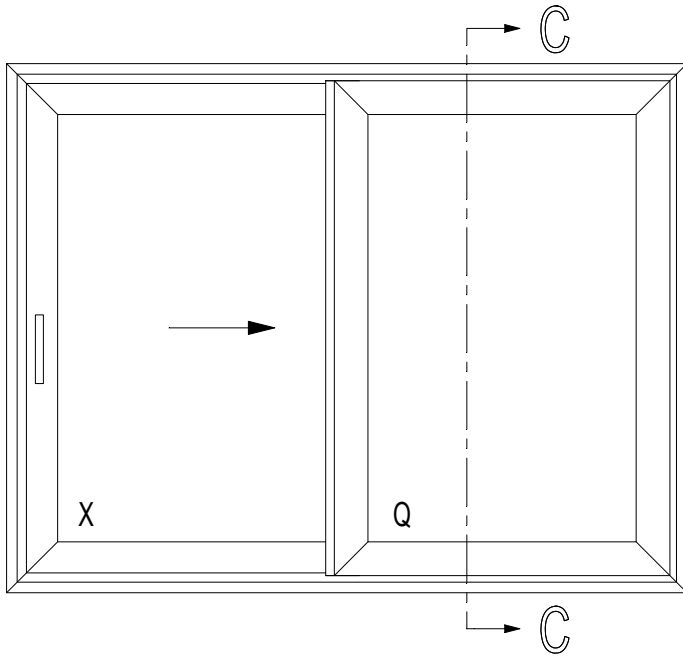

VLEUGELGEWICHT POIDS DU VANTAIL WEIGHT OF THE VENT FLUEGELGEWICHT	MAX. 300KG
--	------------

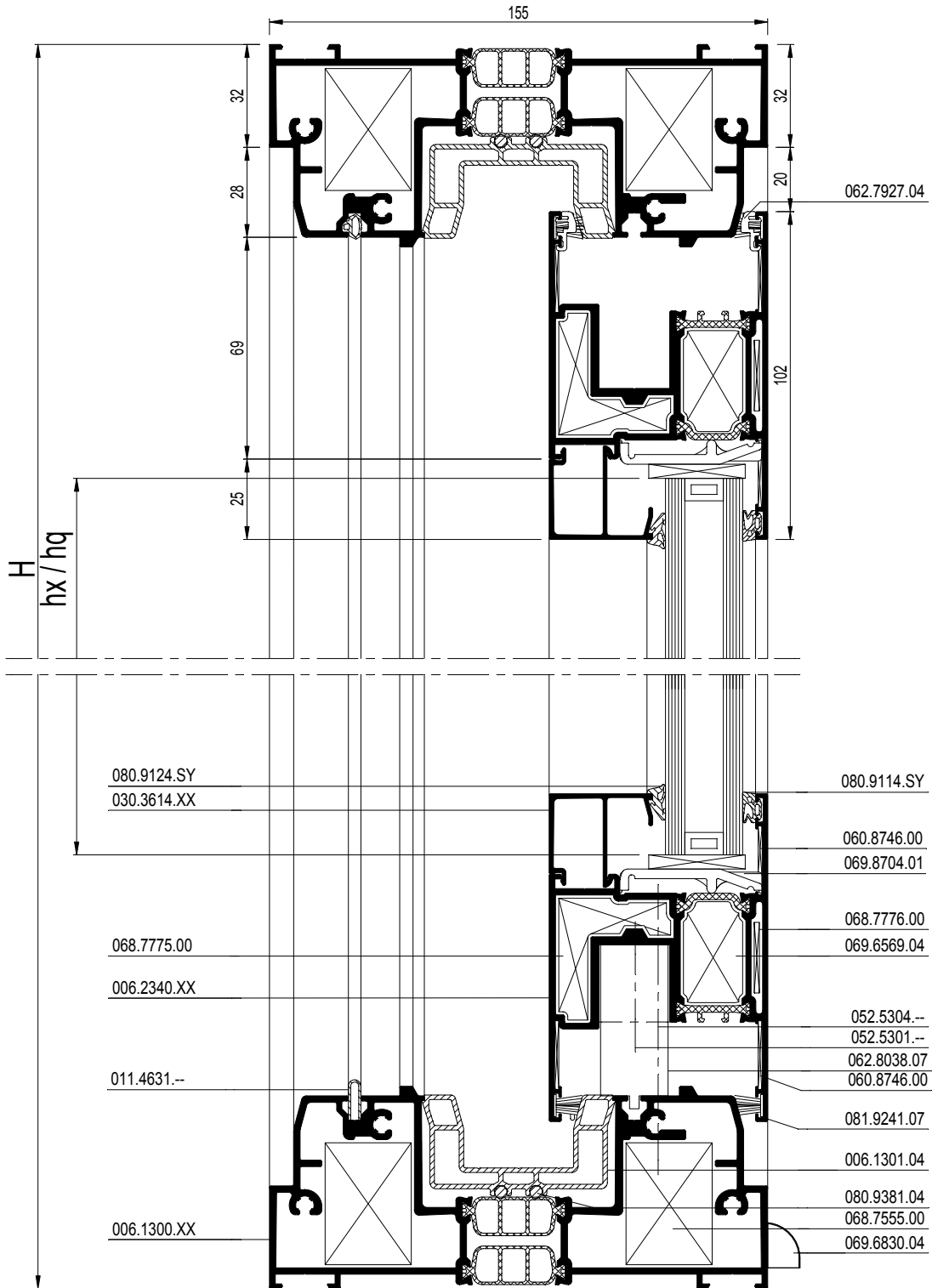

schaal - échelle
 Maßstab - scale
 1/2

D0090782

VLEUGELGEWICHT POIDS DU VANTAIL WEIGHT OF THE VENT FLUEGELGEWICHT	MAX. 250KG
--	------------

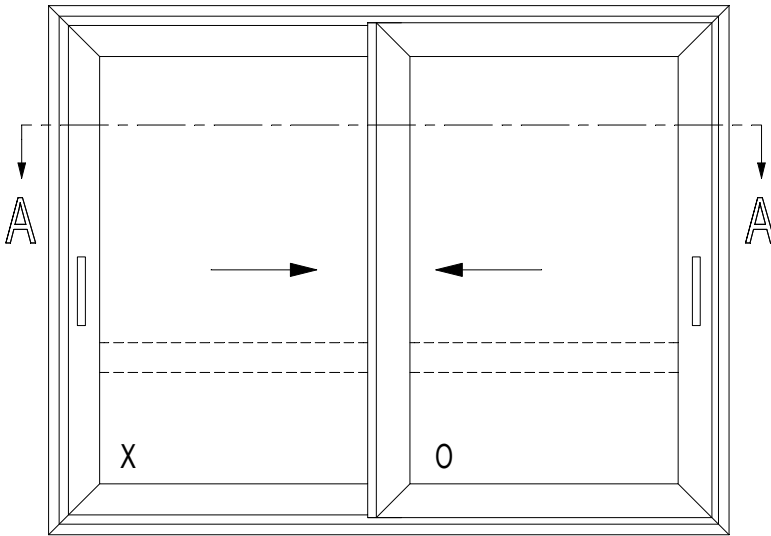

A - A

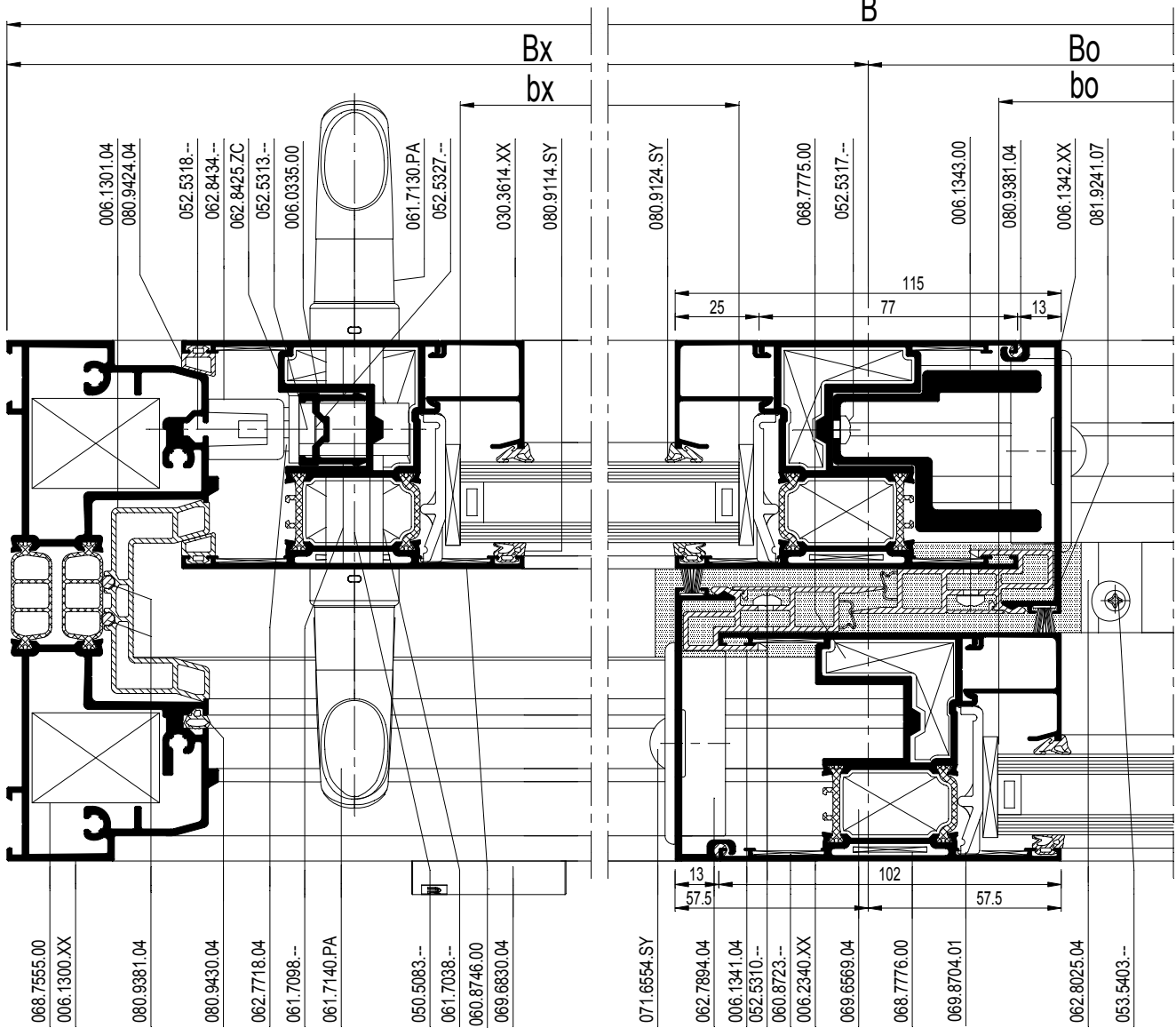

schaal - échelle
 Maßstab - scale
 1/2

D0013913

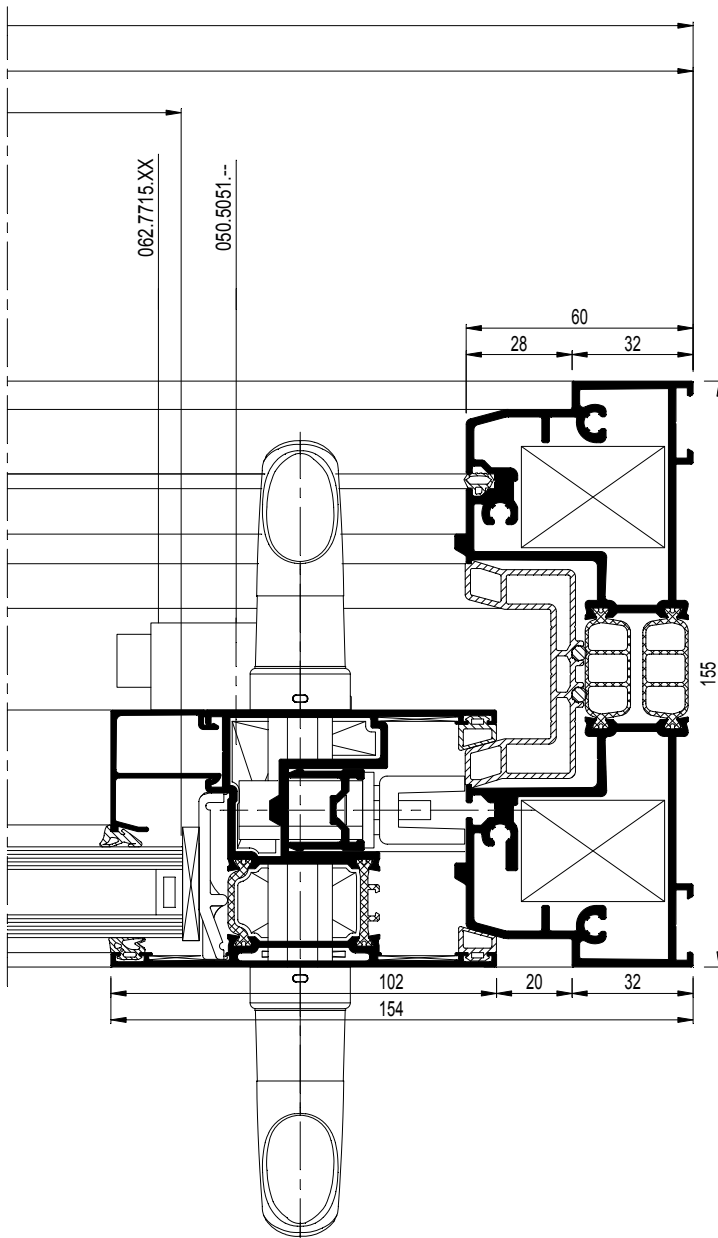

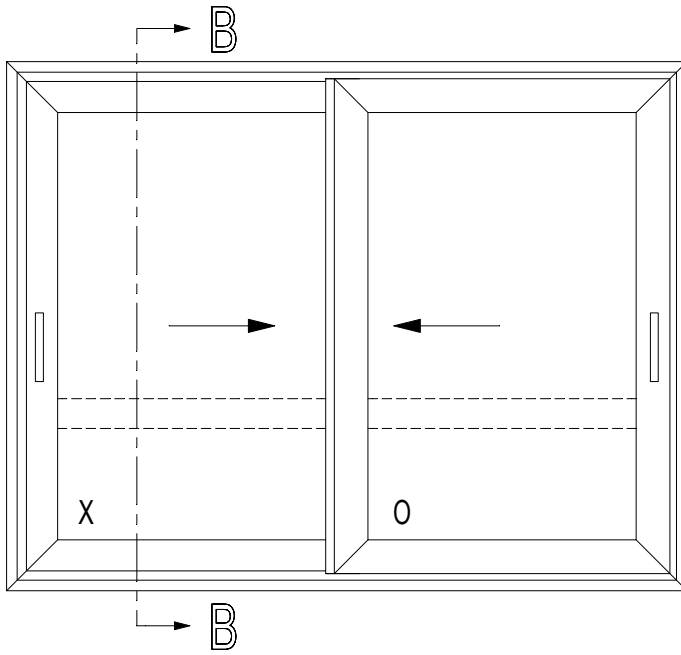

VLEUGELGEWICHT POIDS DU VANTAIL WEIGHT OF THE VENT FLUEGELGEWICHT	MAX. 250KG
--	------------

B - B

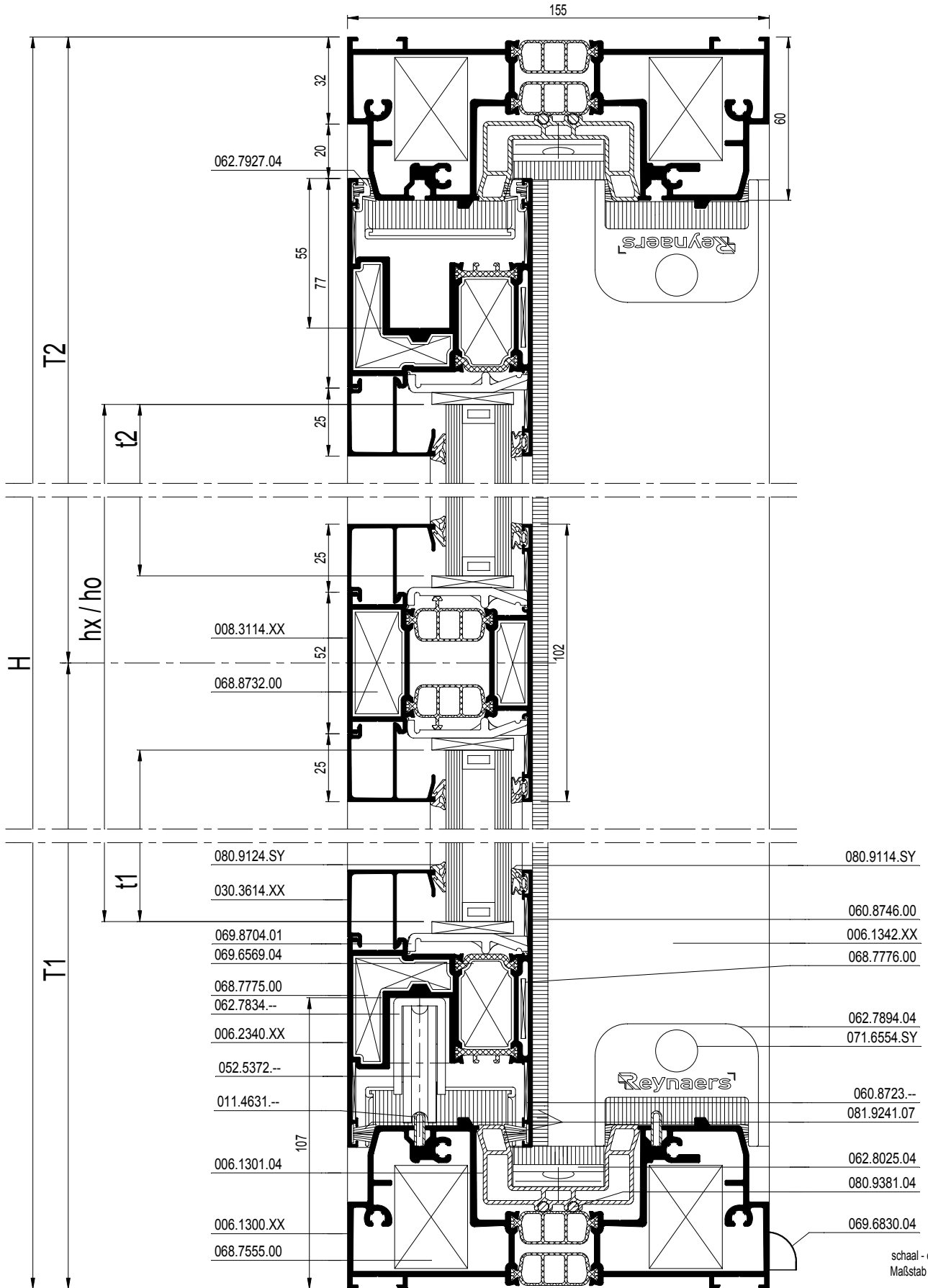







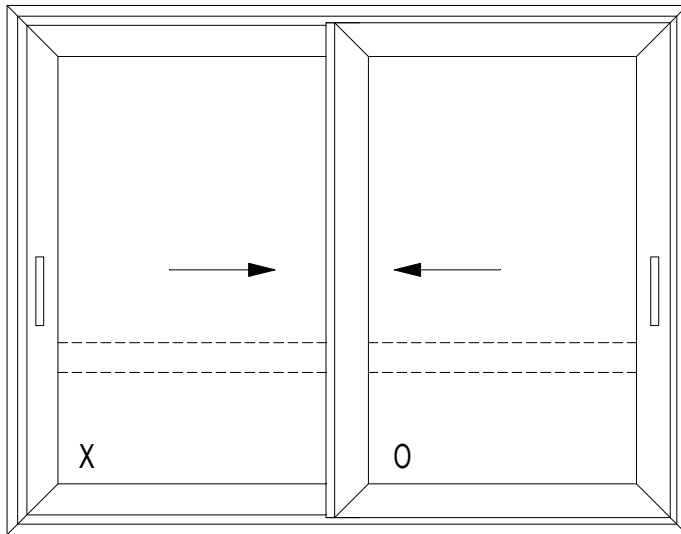























schaal - échelle
 Maßstab - scale
 1/2

D0013914

VLEUGELGEWICHT POIDS DU VANTAIL WEIGHT OF THE VENT FLUEGELGEWICHT	MAX. 250KG
--	------------



			#	$\leftarrow L_m \rightarrow$	
006.1300.XX			2	B	34.C. ...
006.1301.04			2	H	
011.4631.--			2	B-116	34.C. ...
006.2340.XX			2	Bx-7.5	34.C. ...
			2	Bo-7.5	
			4	H-104	
006.1342.XX			2	H-104	34.C. ...
006.1341.04			2	H-104	34.C. ...
006.1343.00			1	H-162	34.C. ...
006.0335.00			2	280MM	34.C. ...
				(062.8425.ZC)	
			2	H-214	
030.3614.XX			2	Bx-161.5	34.C. ...
			2	Bo-161.5	
			4	H-308	
+			1	Bx-161.5	34.C. ...
			1	Bo-161.5	

bx = Bx-173.5
hx = H-270
bo = Bo-173.5
ho = H-270

met dwarsstijl
avec traverse
with transom
mit Sprossenprofil

t1 = T1-167
t2 = T2-167

		#	
068.7555.00		8	34.G. ...
068.7775.00		8	34.G. ...
069.6569.04		8	34.G. ...
068.7776.00		8	34.G. ...
060.8723.--		16	34.G. ...
060.8746.00		8	34.G. ...
062.7894.04		2	34.G. ...
052.5317.--		4	34.G. ...
071.6554.SY		4	34.G. ...
062.7927.04		min. 8	34.G. ...
062.8425.ZC		2	34.G. ...
052.5313.--		4	34.G. ...
062.8434.--		2	34.G. ...
052.5318.--		6	34.G. ...
052.5327.--		4	34.G. ...
062.8426.ZC		2	34.G. ...
052.5313.--		26	34.G. ...
062.8440.--		2	34.G. ...
052.5318.--		24	34.G. ...
052.5327.--		12	34.G. ...
062.7718.04		2	34.G. ...
061.7130.PA		2	34.G. ...
050.5083.--		6	34.G. ...
061.7140.PA		2	34.G. ...
061.7038.--		2	34.G. ...
061.7098.--		2	34.G. ...
062.7715.XX		1	34.G. ...
050.5051.--		1	34.G. ...
062.7834.--		4	34.G. ...
052.5372.--		8	34.G. ...
062.8025.04		1	34.G. ...
053.5403.--		4	34.G. ...
052.5310.--		2xH (3/m)	34.G. ...
052.5317.--		H (3/m)	34.G. ...
069.8704.01		16	34.G. ...
062.6857.04		1	34.G. ...
069.6830.04		min. 2	34.G. ...
080.9424.04		4xH	34.G. ...
080.9124.SY		(2xB)+(4xH)	34.G. ...
080.9114.SY		(2xB)+(4xH)	34.G. ...
080.9381.04		(4xB)+(6xH)	34.G. ...
081.9241.07		(4xB)+(2xH)	34.G. ...
080.9430.04		1xH	34.G. ...

(*)

met dwarsstijl
avec traverse
with transom
mit Sprossenprofil
+

068.8732.00		4	34.G. ...
050.5153.--		8	
069.8704.01		8	34.G. ...
080.9124.SY		2xB	34.G. ...
080.9114.SY		2xB	34.G. ...

VARIANT HI

080.9439.04		(1xB)+(3xH)	34.G. ...
080.9625.07		(2xB)+(4xH)	34.G. ...

(*)
Afhankelijk van de hoogte
Dépend de l'hauteur
Dependent of the height
Von der Höhe abhängig

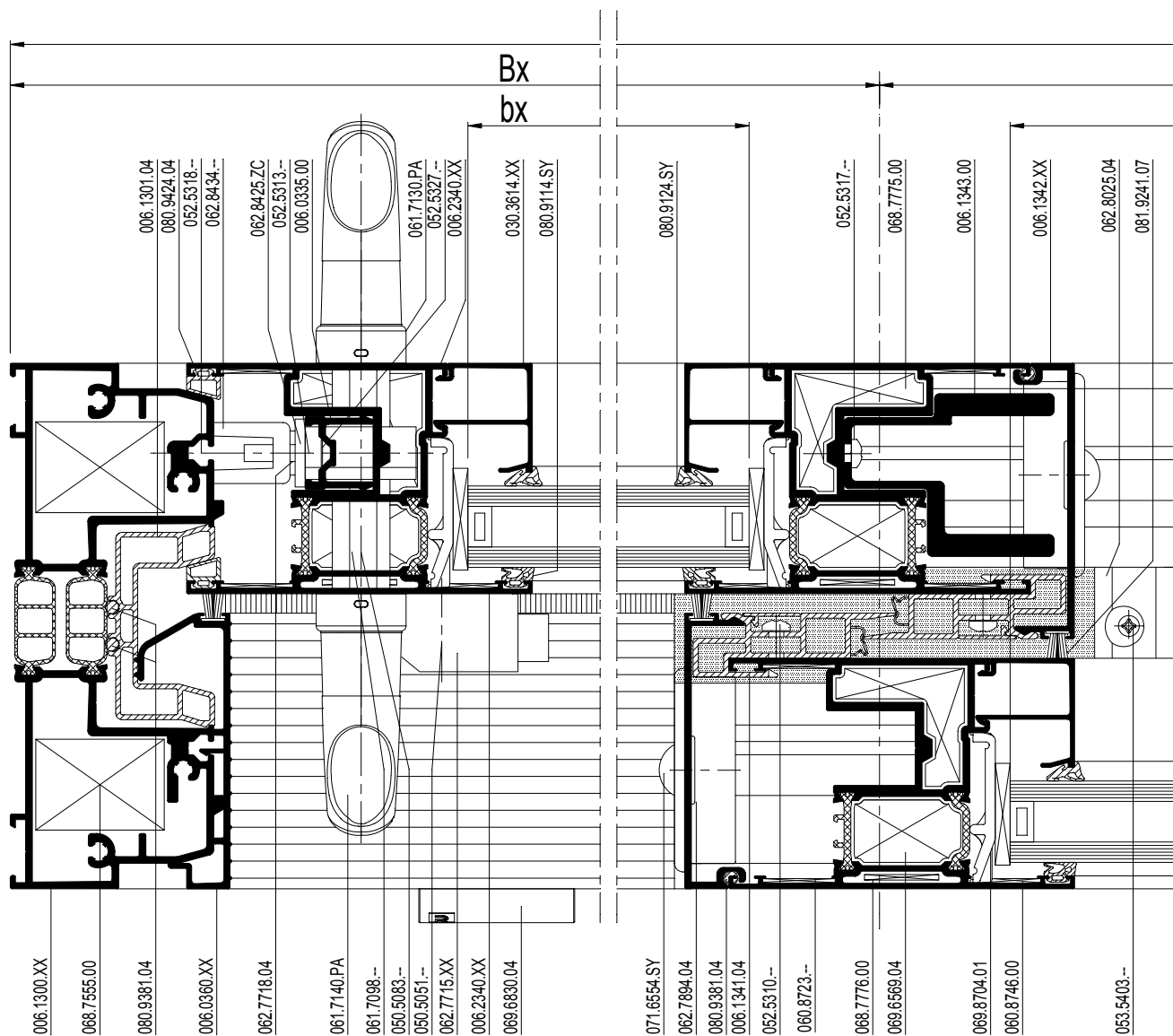
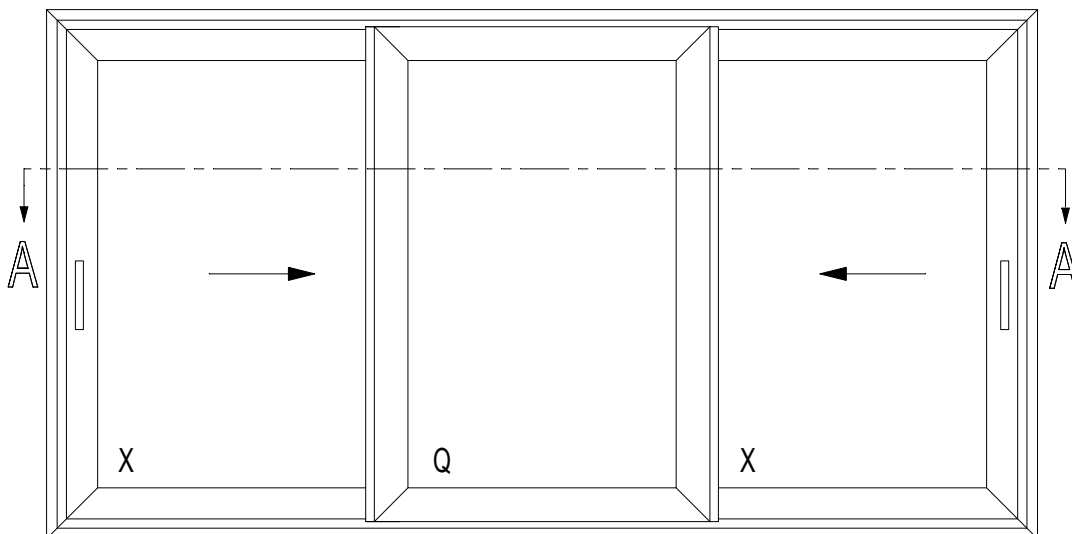

schaal - échelle
 Maßstab - scale
 1/2

D0013915

VLEUGELGEWICHT POIDS DU VANTAIL WEIGHT OF THE VENT FLUEGELGEWICHT	MAX. 250KG
--	------------

A - A

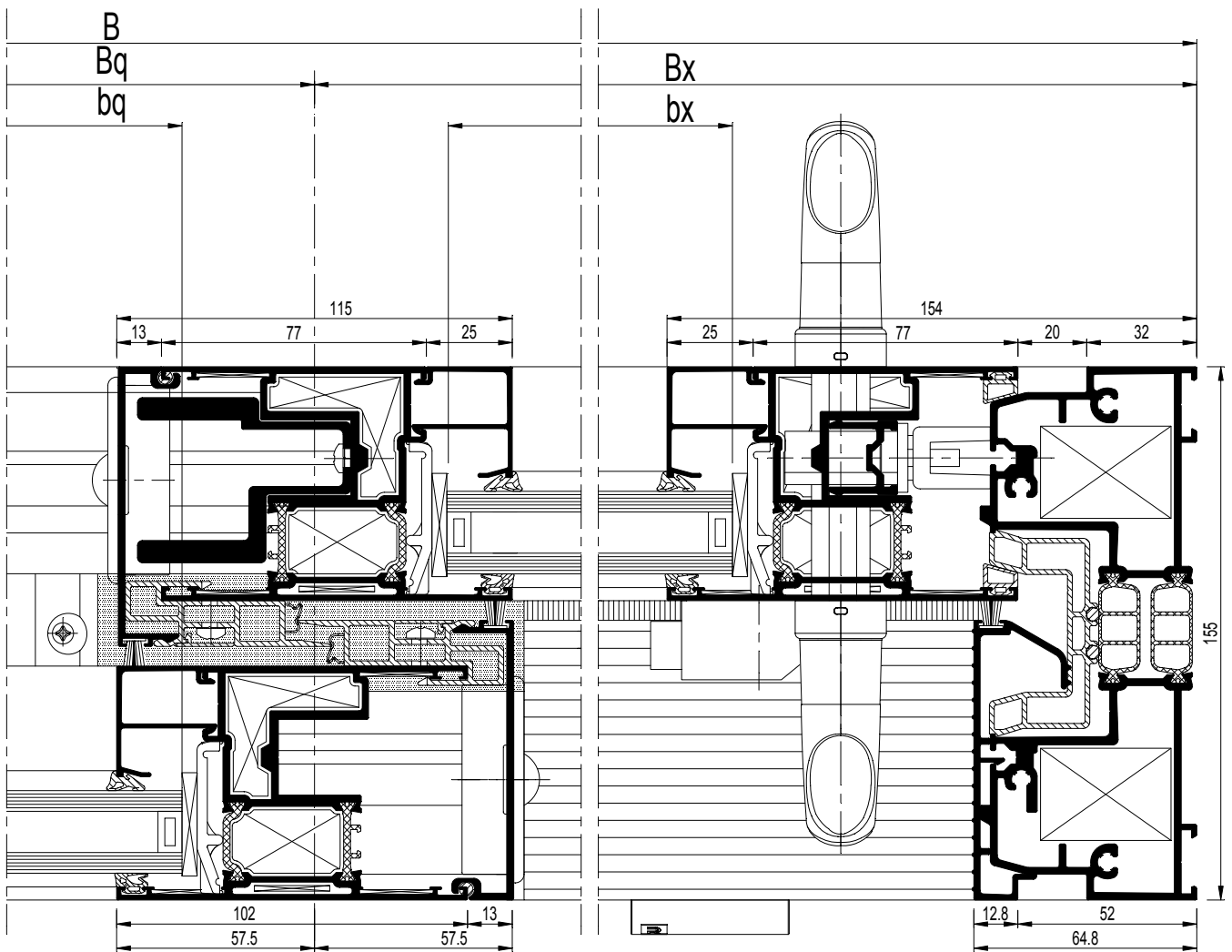

schaal - échelle
 Maßstab - scale
 1/2

D0013915

CP 155

2-RAIL XQX
2-RAIL XQX
2-RAIL XQX
2-RAIL XQX

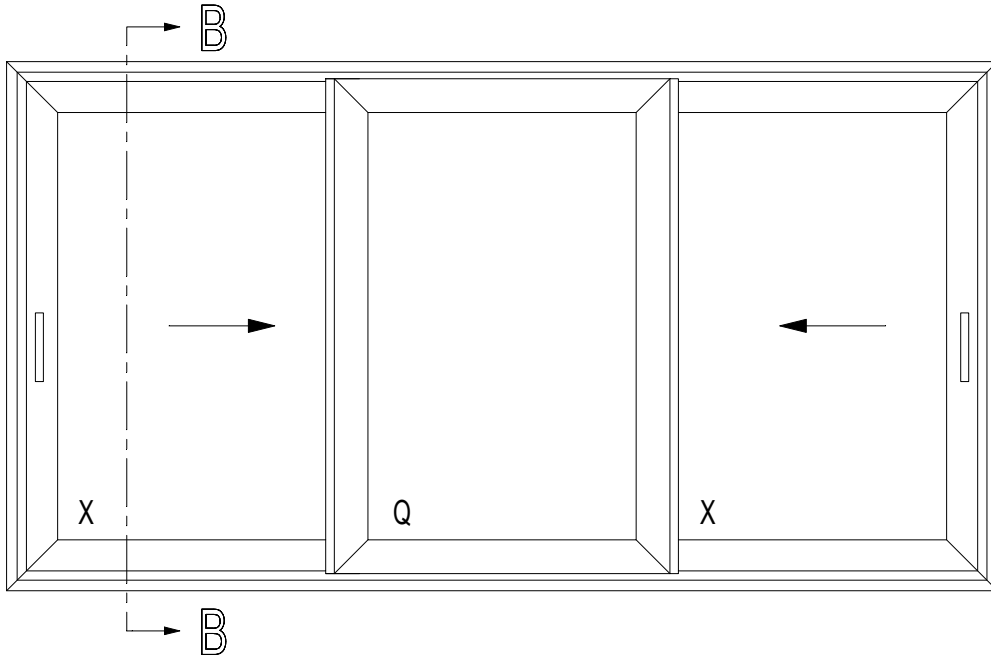

VLEUGELGEWICHT POIDS DU VANTAIL WEIGHT OF THE VENT FLUEGELGEWICHT	MAX. 250KG
--	------------

schaal - échelle
Maßstab - scale
1/2
D0013916

B - B

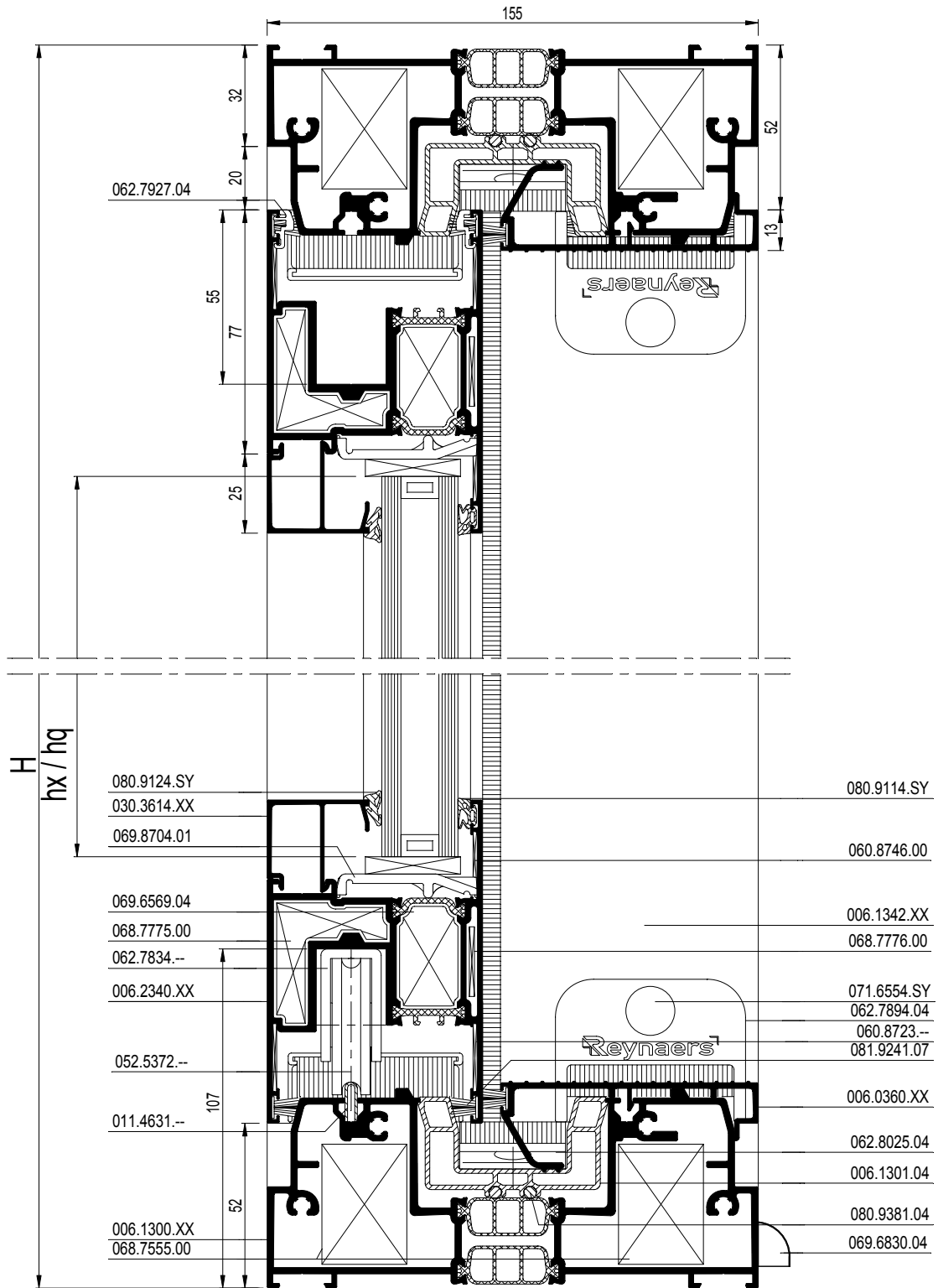

schaal - échelle
 Maßstab - scale
 1/2

D0013916

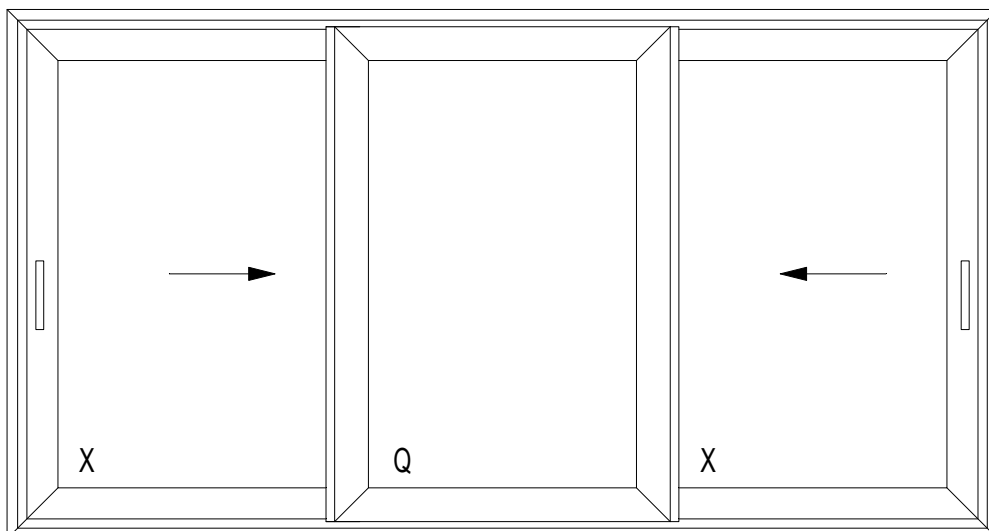



			#	$\leftarrow L_m \rightarrow$		
006.1300.XX 006.1301.04			2	B	34.C. ...	bx = Bx-173.5 hx = H-270 bq = Bq-77 ho = H-270
			2	H		
011.4631.--			1	B-116	34.C. ...	
006.2340.XX			4	Bx-7.5	34.C. ...	
			2	Bq+89		
			6	H-104		
006.1342.XX			4	H-104	34.C. ...	
006.1341.04			4	H-104	34.C. ...	
006.1343.00			2	H-162	34.C. ...	
006.0335.00			2	280MM	34.C. ...	
				(062.8425.ZC)		
			2	H-214 <small>OF-OU-ORDER</small>		
030.3614.XX			4	Bx-161.5	34.C. ...	
			2	Bq-65		
			6	H-308		
006.0360.XX			2	Bx-97	34.C. ...	
			2	Bx-97		
			2	H-75.6		

VLEUGELGEWICHT POIDS DU VANTAIL WEIGHT OF THE VENT FLUEGELGEWICHT	MAX. 250KG
--	------------

		#	
068.7555.00		8	34.G. ...
068.7775.00		12	34.G. ...
069.6569.04		12	34.G. ...
068.7776.00		12	34.G. ...
060.8723.--		24	34.G. ...
060.8746.00		12	34.G. ...
062.7894.04		4	34.G. ...
052.5317.--		8	34.G. ...
071.6554.SY		8	34.G. ...
062.7927.04		min. 12	34.G. ...
062.8425.ZC		2	34.G. ...
052.5313.--		4	34.G. ...
062.8434.--		2	34.G. ...
052.5318.--		6	34.G. ...
052.5327.--		4	34.G. ...
062.8426.ZC		2	34.G. ...
052.5313.--		26	34.G. ...
062.8440.--		2	34.G. ...
052.5318.--		24	34.G. ...
052.5327.--		12	34.G. ...
062.7718.04		2	34.G. ...
061.7130.PA		2	34.G. ...
050.5083.--		6	34.G. ...
061.7140.PA		2	34.G. ...
061.7038.--		2	34.G. ...
061.7098.--		2	34.G. ...
062.7715.XX		2	34.G. ...
050.5051.--		2	34.G. ...
062.7834.--		4	34.G. ...
052.5372.--		8	34.G. ...
062.8038.07		3	34.G. ...
052.5301.--		3	34.G. ...
052.5304.--		3	34.G. ...
062.8025.04		2	34.G. ...
053.5403.--		8	34.G. ...
052.5310.--		4xH (3/m)	34.G. ...
052.5317.--		2xH (3/m)	34.G. ...
062.6857.04		2	34.G. ...
069.8704.01		24	34.G. ...
069.6830.04		min. 2	34.G. ...
080.9424.04		4xH	34.G. ...
080.9124.SY		(2xB)+(6xH)	34.G. ...
080.9114.SY		(2xB)+(6xH)	34.G. ...
080.9381.04		(4xB)+(8xH)	34.G. ...
081.9241.07		(4xB)+(6xH) +(4xBx)	34.G. ...

(*)

VARIANT HI

080.9439.04		(1xB)+(4xH)	34.G. ...
080.9625.07		(2xB)+(6xH)	34.G. ...

(*) Afhankelijk van de hoogte
Dépend de l'hauteur
Dependent of the height
Von der Höhe abhängig

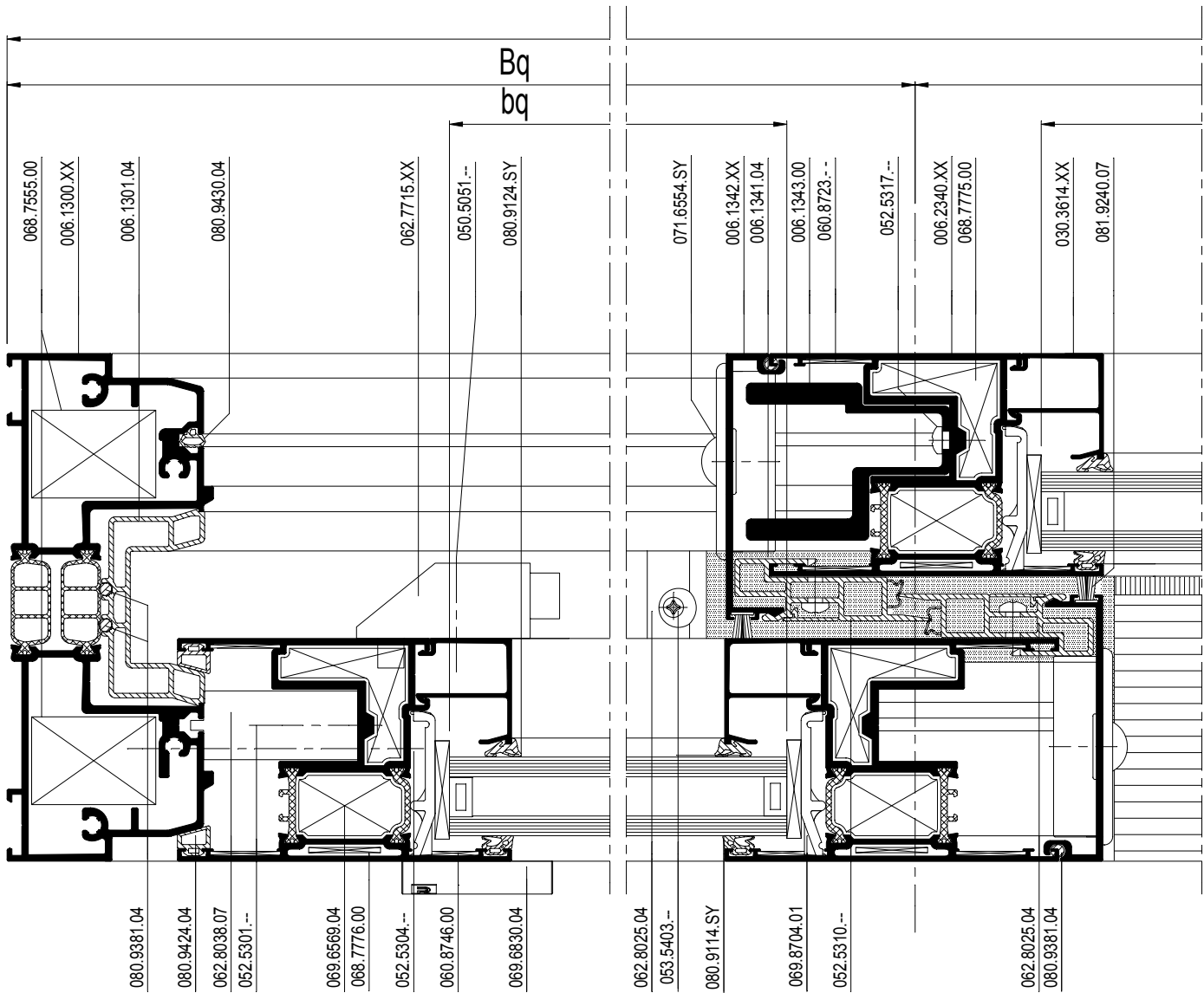
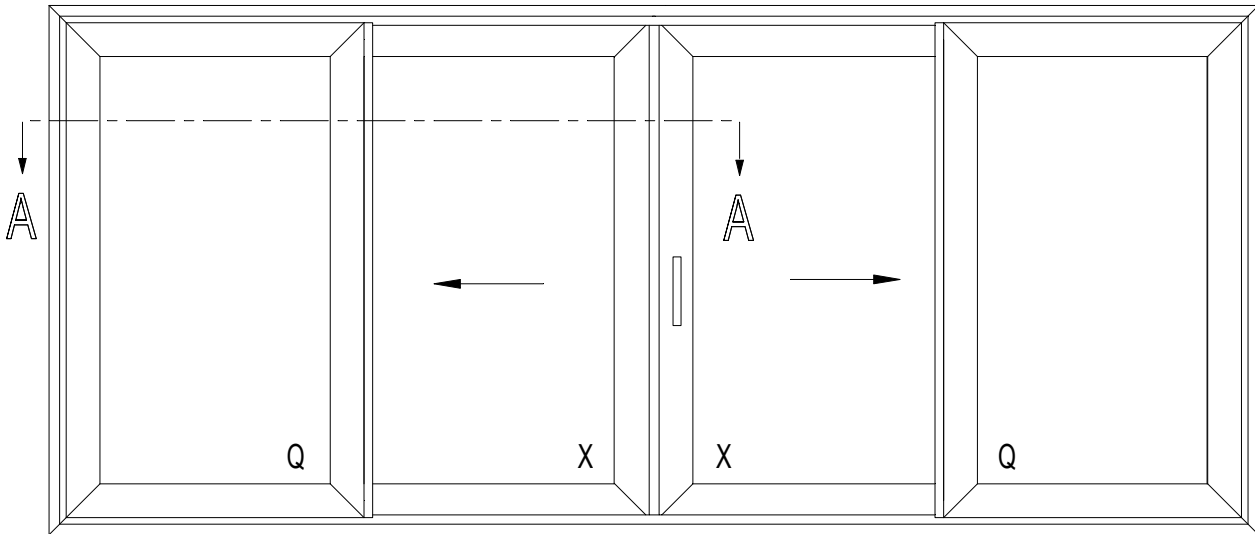

schaal - échelle
 Maßstab - scale
 1/2

D0013917

VLEUGELGEWICHT POIDS DU VANTAIL WEIGHT OF THE VENT FLUEGELGEWICHT	MAX. 250KG
--	------------

A - A

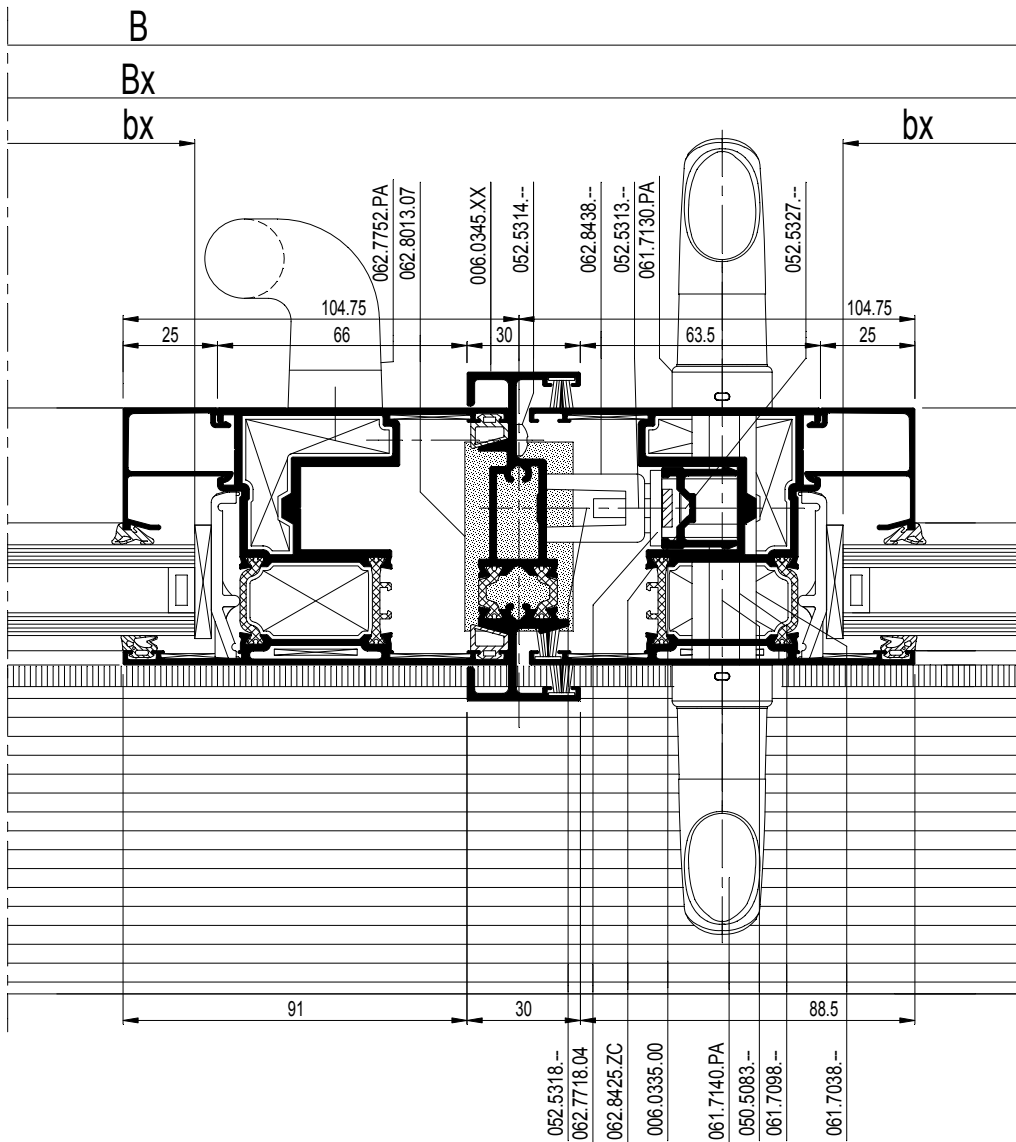

schaal - échelle
 Maßstab - scale
 1/2

D0013917

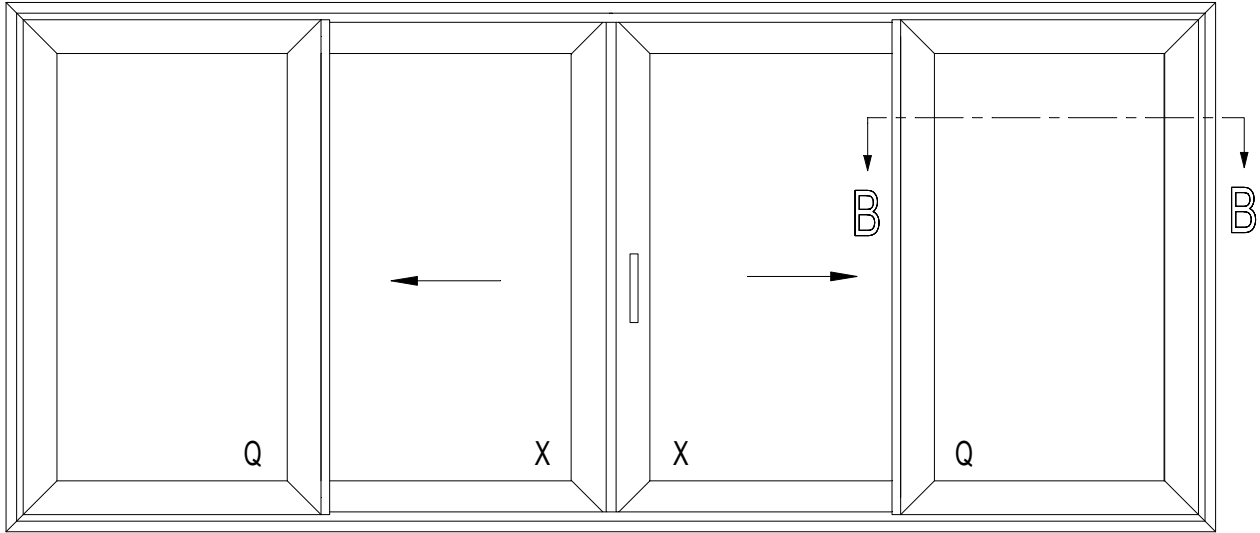

B - B

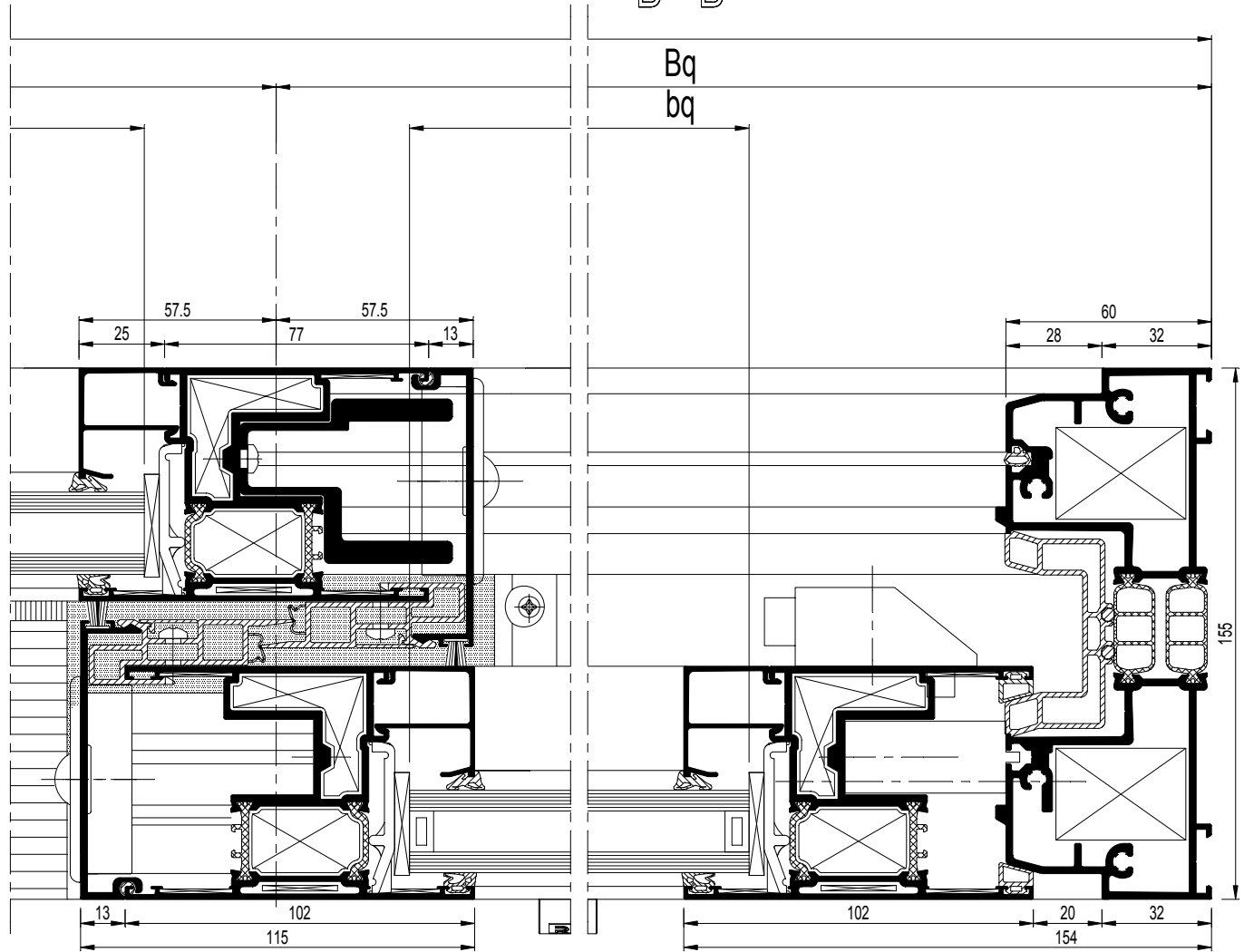

schaal - échelle
 Maßstab - scale
 1/2

D0013918

VLEUGELGEWICHT POIDS DU VANTAIL WEIGHT OF THE VENT FLUEGELGEWICHT	MAX. 250KG
--	------------

		#	
068.7555.00		8	34.G. ...
068.7775.00		16	34.G. ...
069.6569.04		16	34.G. ...
068.7776.00		16	34.G. ...
060.8723.--		32	34.G. ...
060.8746.00		16	34.G. ...
062.7894.04		4	34.G. ...
052.5317.--		8	34.G. ...
071.6554.SY		8	34.G. ...
062.7927.04		min.16	34.G. ...
062.8425.ZC		1	34.G....
052.5313.--		2	34.G....
062.8438.--		1	34.G....
052.5318.--		2	34.G....
052.5327.--		2	34.G....
062.8426.ZC		1	34.G....
052.5313.--		13	34.G....
062.8441.--		1	34.G....
052.5318.--		12	34.G....
052.5327.--		6	34.G....
062.7718.04		1	34.G. ...
061.7130.PA		1	34.G. ...
050.5083.--		3	34.G. ...
061.7140.PA		1	34.G. ...
061.7038.--		1	34.G. ...
061.7098.--		1	34.G. ...
062.7752.PA		1	34.G. ...
057.5711.--		2	34.G. ...
050.5011.--		2	34.G. ...
062.7715.XX		2	34.G. ...
050.5051.--		2	34.G. ...
062.7834.--		4	34.G. ...
052.5372.--		8	34.G. ...
062.8038.07		12	34.G. ...
052.5301.--		12	34.G. ...
052.5304.--		12	34.G. ...
062.8025.04		2	34.G. ...
053.5403.--		8	34.G. ...

(*)

(*) Afhankelijk van de hoogte
Dépend de l'hauteur
Dependent of the height
Von der Höhe abhängig

		#	
062.8013.07		1	34.G. ...
052.5310.--		4	34.G. ...
052.5310.--		4xH (3/m)	34.G. ...
052.5317.--		2xH (3/m)	34.G. ...
052.5314.--		H (3/m)	34.G. ...
062.6857.04		2	34.G. ...
069.8704.01		32	34.G. ...
069.6830.04		min. 2	34.G. ...
080.9424.04		6xH	34.G. ...
080.9124.SY		(2xB)+(8xH)	34.G. ...
080.9114.SY		(2xB)+(8xH)	34.G. ...
080.9381.04		(4xB)+(8xH)	34.G. ...
081.9241.07		(4xB)+(7xH) +(2xBx)	34.G. ...
080.9430.04		2xH	34.G. ...

VARIANT HI

080.9439.04		(1xB)+(6xH)	34.G. ...
080.9625.07		(2xB)+(8xH)	34.G. ...

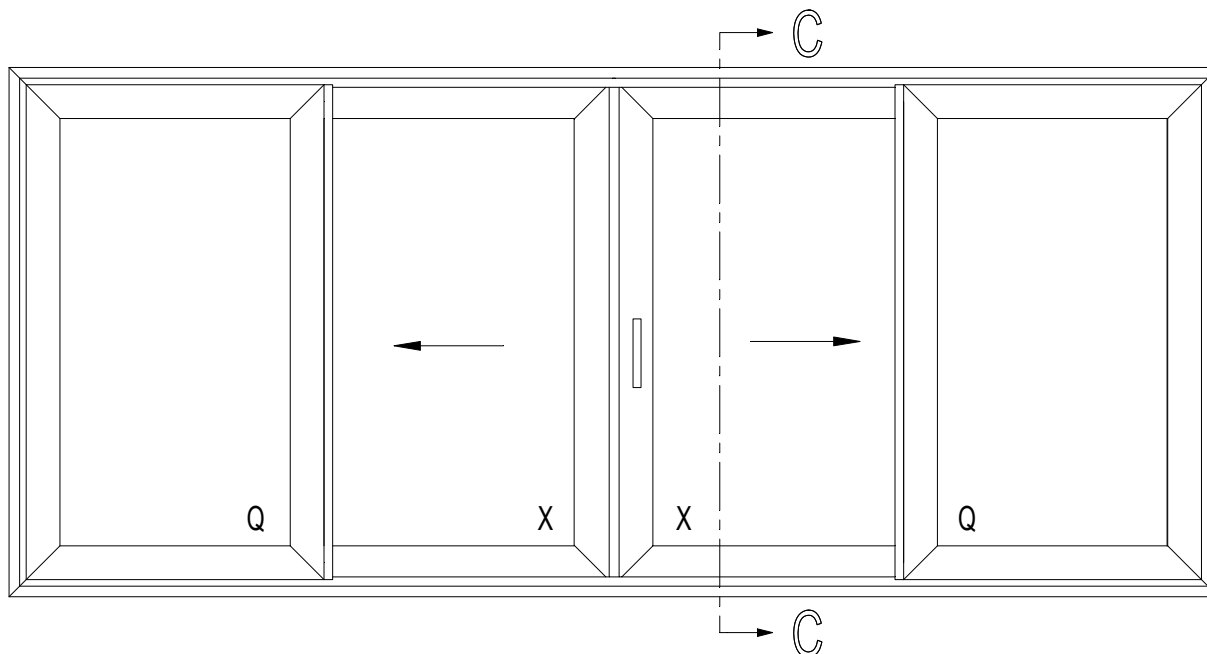

			#	L_m		
006.1300.XX 006.1301.04			2	B	34.C....	$bx = (Bx:2)-124.2$
			2	H		$hx = H-270$
011.4631.--			1	B-116	34.C....	$bq = Bq-173.5$
006.2340.XX			4	$(Bx:2)+41.7$	34.C....	$hq = H-270$
			4	$Bq-7.5$		
			8	H-104		
006.1342.XX			4	H-104	34.C....	
006.1341.04			4	H-104	34.C....	
006.1343.00			2	H-162	34.C....	
006.0335.00			1	280MM	34.C....	
				(062.8425.ZC) OF-OU-OR-ODER H-214		
			1	(062.8426.ZC)		
006.0345.XX			1	H-104	34.C....	
030.3614.XX			4	$(Bx:2)-112.2$	34.C....	
			4	$Bq-161.5$		
			8	H-308		
006.0360.XX			2	$Bx-121.5$	34.C....	

VLEUGELGEWICHT POIDS DU VANTAIL WEIGHT OF THE VENT FLUEGELGEWICHT	MAX. 250KG
--	------------

C - C

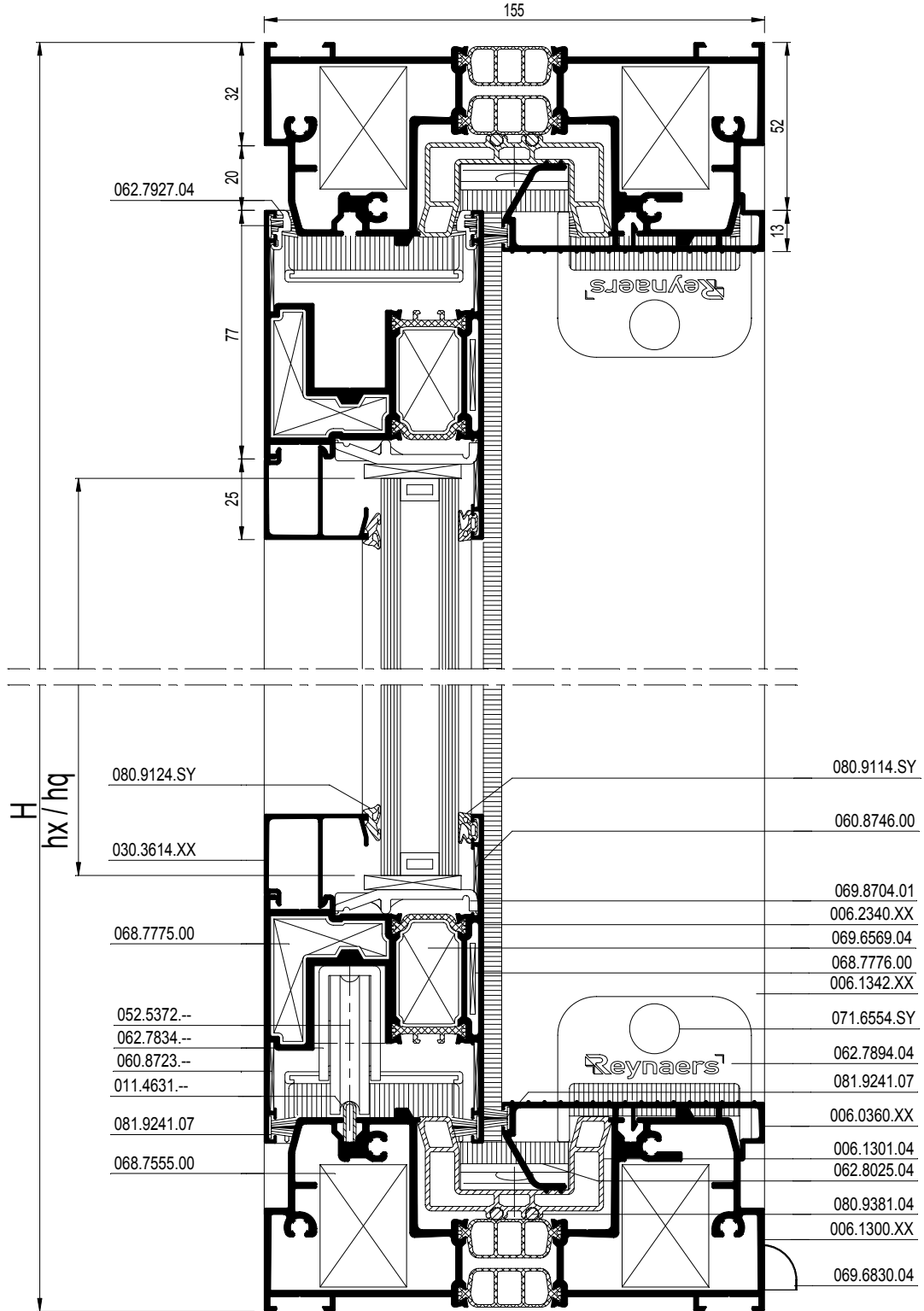

schaal - échelle
 Maßstab - scale
 1/2

D0013919

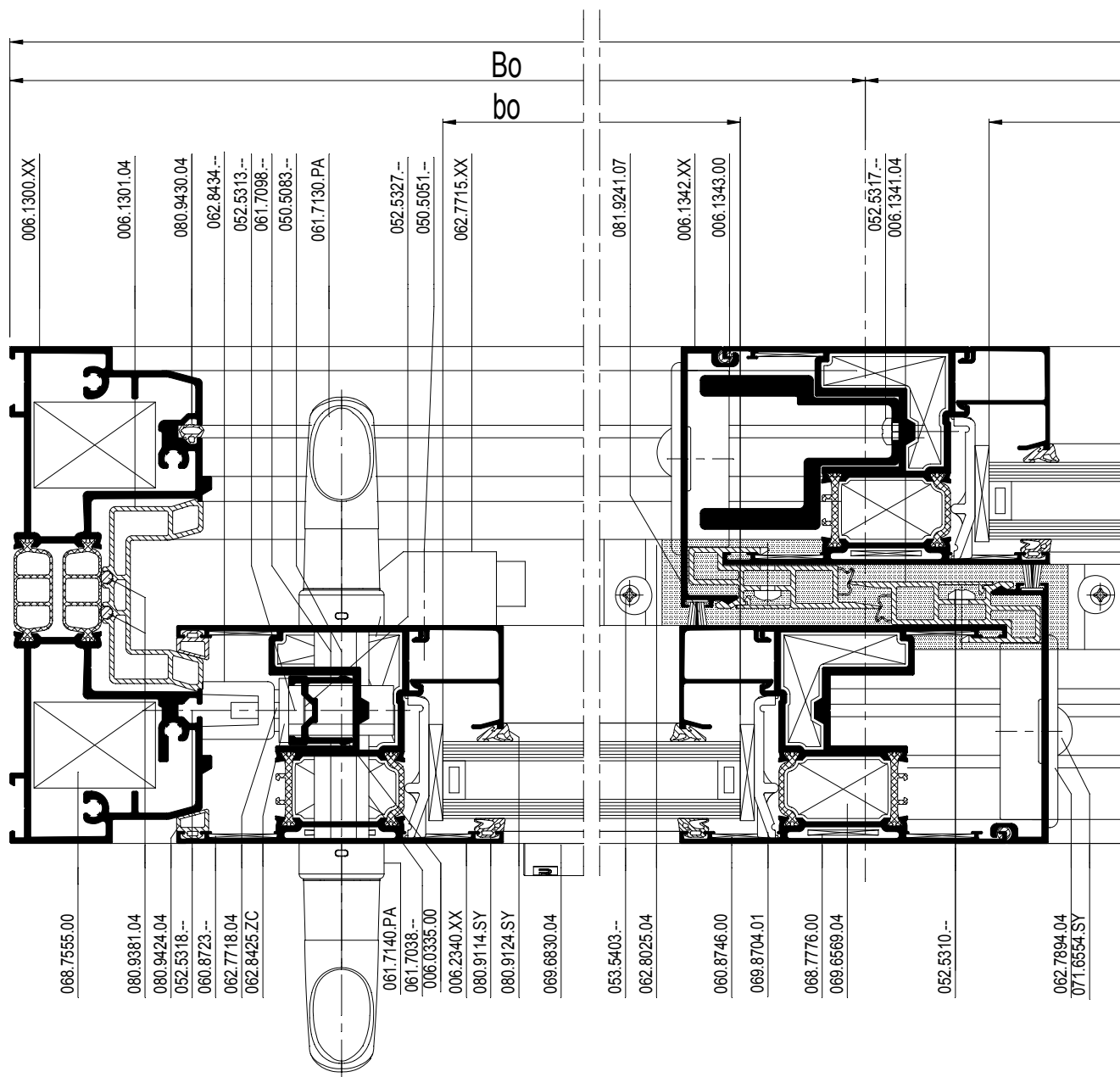
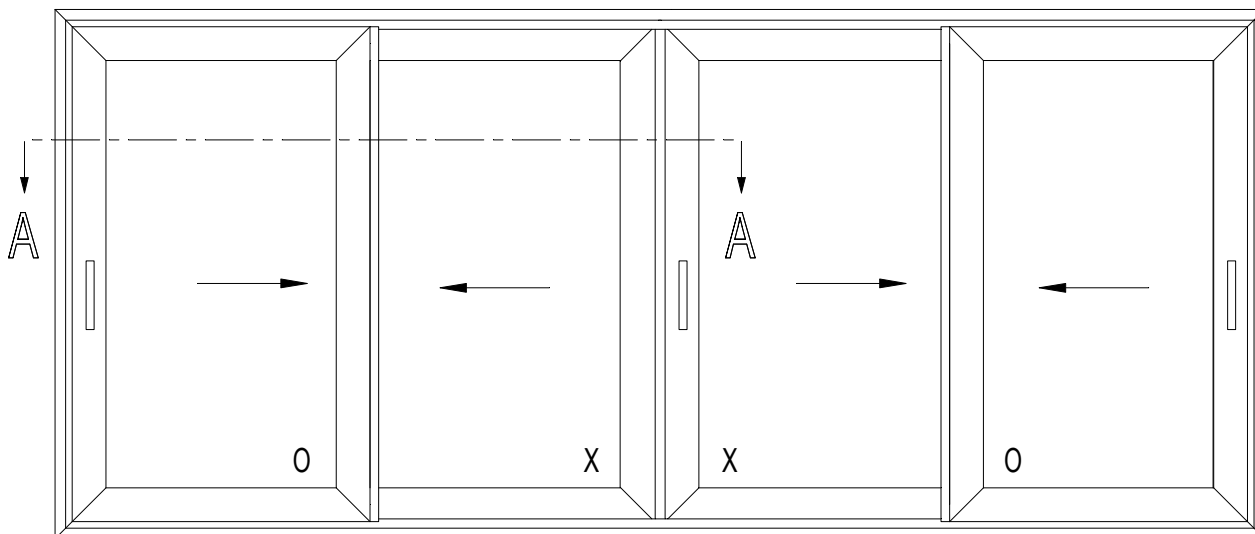

VLEUGELGEWICHT POIDS DU VANTAIL WEIGHT OF THE VENT FLUEGELGEWICHT	MAX. 250KG
--	------------

A - A

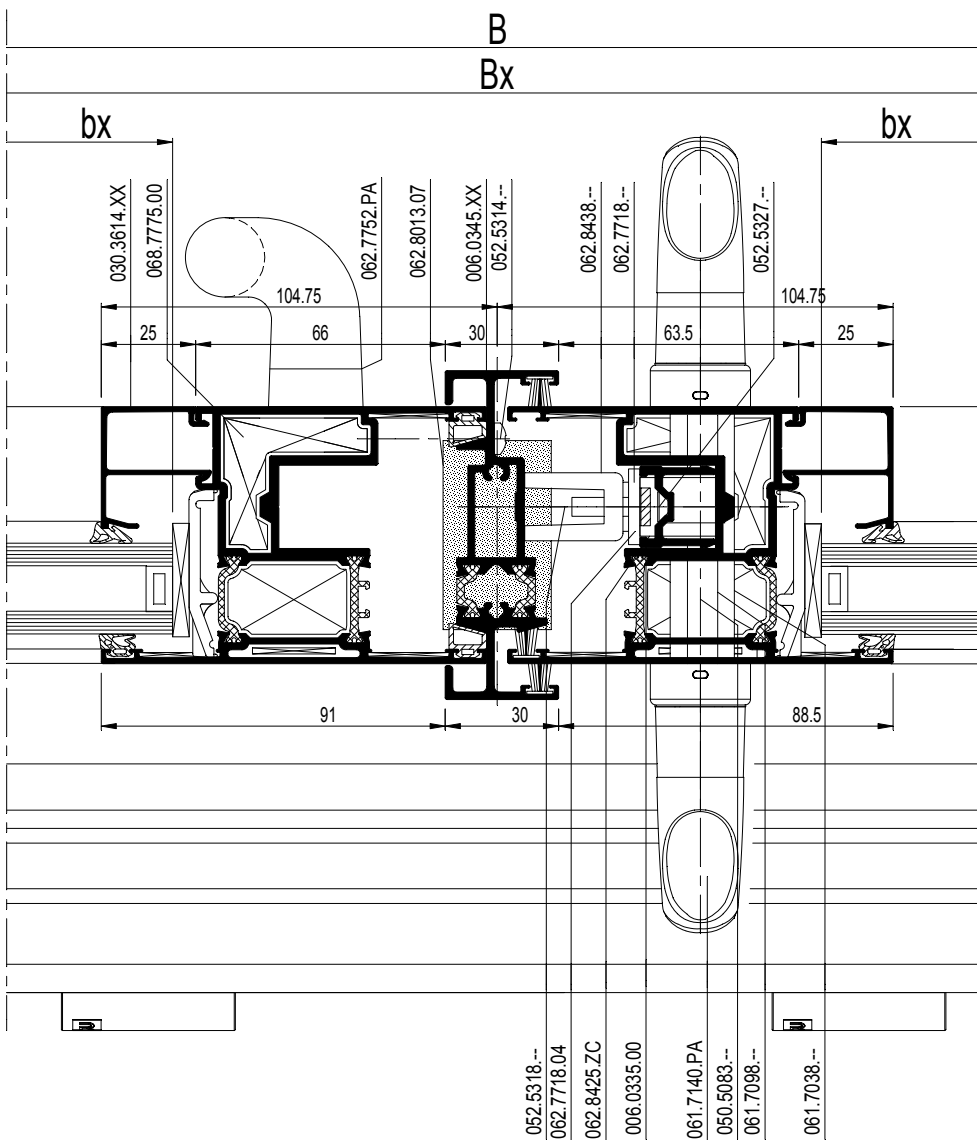

schaal - échelle
 Maßstab - scale
 1/2

D0013920

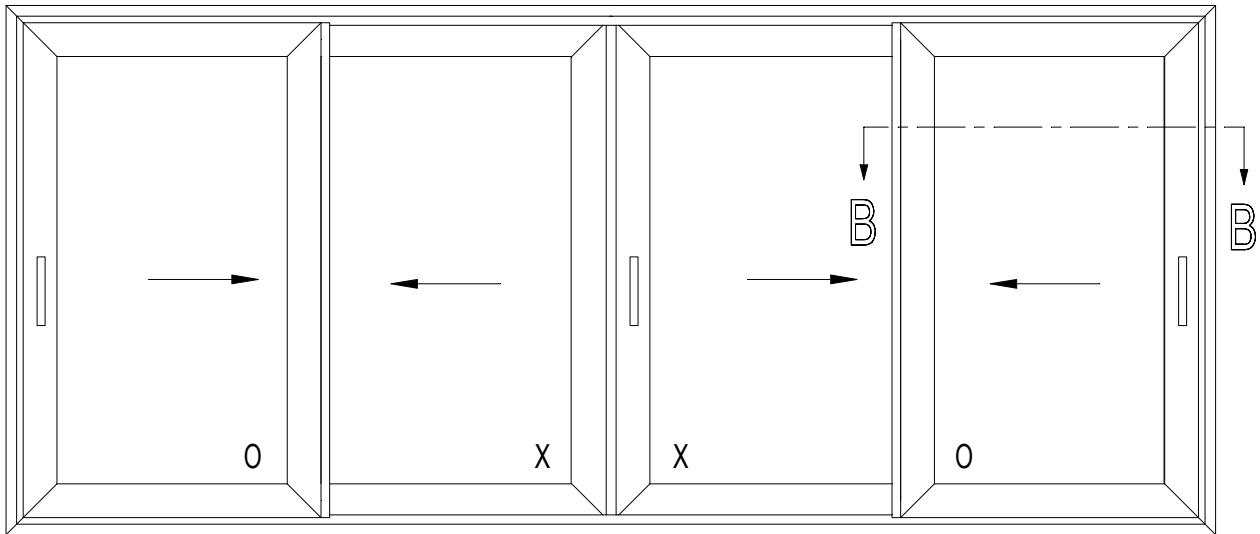

B - B

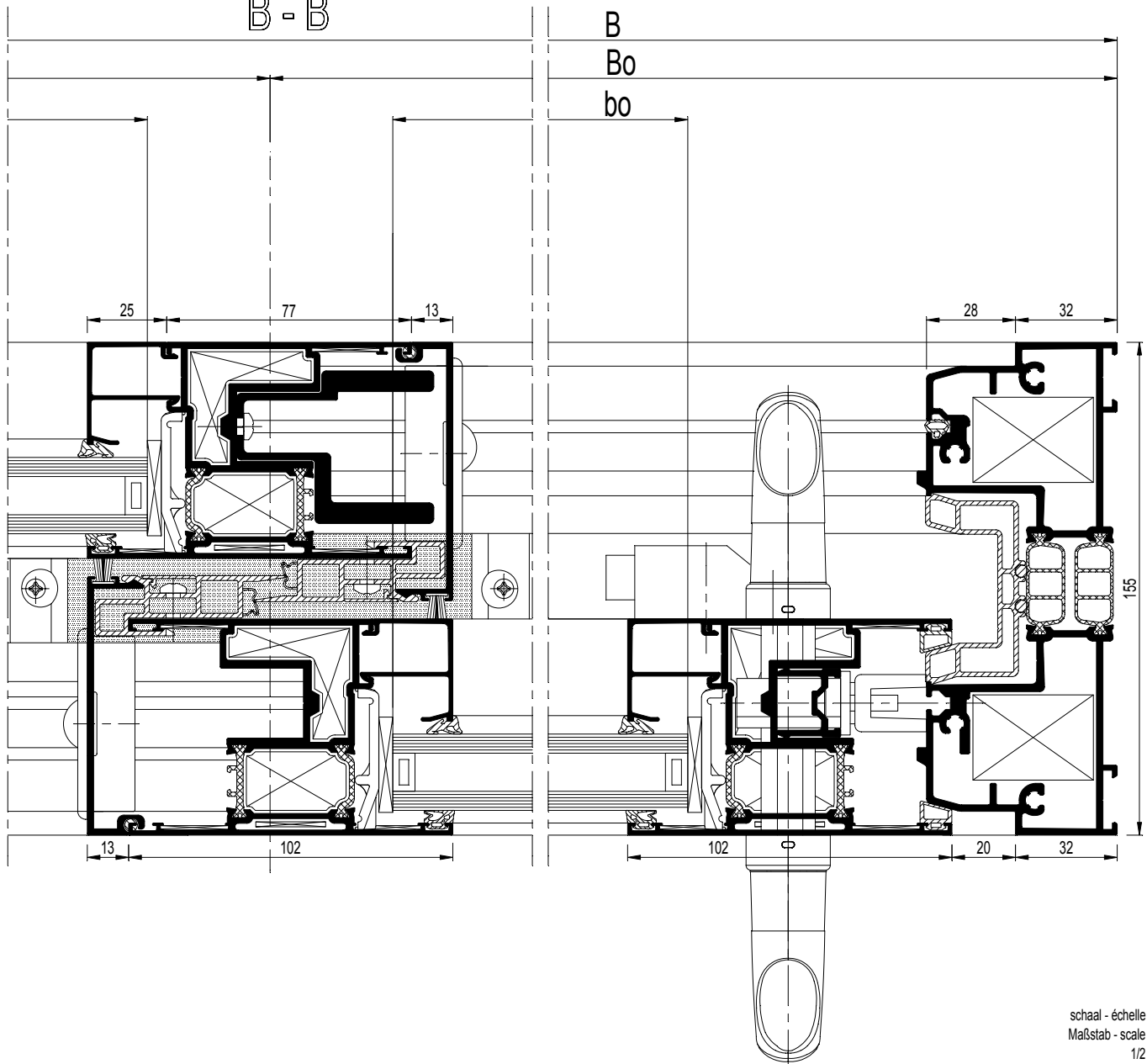

schaal - échelle
 Maßstab - scale
 1/2

D0013921

VLEUGELGEWICHT POIDS DU VANTAIL WEIGHT OF THE VENT FLUEGELGEWICHT	MAX. 250KG
--	------------

		#	
068.7555.00		8	34.G. ...
068.7775.00		16	34.G. ...
069.6569.04		16	34.G. ...
068.7776.00		16	34.G. ...
060.8723.--		32	34.G. ...
060.8746.00		16	34.G. ...
062.7894.04		4	34.G. ...
052.5317.--		8	34.G. ...
071.6554.SY		8	34.G. ...
062.7927.04		min.16	34.G. ...
062.8425.ZC		2	34.G....
052.5313.--		4	34.G....
062.8434.--		2	34.G....
052.5318.--		6	34.G....
(*) 052.5327.-- <small>OF-OU-OR-ODER</small>		4	34.G....
062.8426.ZC		2	34.G....
052.5313.--		26	34.G....
062.8440.XX		2	34.G....
052.5318.--		24	34.G....
052.5327.--		12	34.G....
062.8425.ZC		1	34.G....
052.5313.--		2	34.G....
062.8438.--		1	34.G....
052.5318.--		2	34.G....
(*) 052.5327.-- <small>OF-OU-OR-ODER</small>		2	34.G....
062.8426.ZC		1	34.G....
052.5313.--		13	34.G....
062.8441.XX		1	34.G....
052.5318.--		12	34.G....
052.5327.--		6	34.G....
061.7130.PA		3	34.G. ...
050.5083.--		9	34.G. ...
062.7718.04		3	34.G. ...
061.7140.PA		3	34.G. ...
061.7038.--		3	34.G. ...
061.7098.--		3	34.G. ...
062.7752.PA		1	34.G. ...
057.5711.--		2	34.G. ...
050.5011.--		2	34.G. ...
062.8434.--		2	34.G. ...
062.8440.XX		2	34.G. ...

(*) Afhankelijk van de hoogte
Dépend de l'hauteur
Dependent of the height
Von der Höhe abhängig

		#	
062.7715.XX		2	34.G. ...
050.5051.--		2	34.G. ...
062.7834.--		8	34.G. ...
052.5372.--		16	34.G. ...
062.8025.04		2	34.G. ...
053.5403.--		8	34.G. ...
062.8013.07		1	34.G. ...
052.5310.--		4	34.G. ...
052.5310.--		4xH (3/m)	34.G. ...
052.5317.--		2xH (3/m)	34.G. ...
052.5314.--		H (3/m)	34.G. ...
069.8704.01		32	34.G. ...
062.6857.04		2	34.G. ...
069.6830.04		min. 2	34.G. ...
080.9424.04		6xH	34.G. ...
080.9124.SY		(2xB)+(8xH)	34.G. ...
080.9114.SY		(2xB)+(8xH)	34.G. ...
080.9381.04		(4xB)+(8xH)	34.G. ...
081.9241.07		(4xB)+(7xH)	34.G. ...
080.9430.04		2xH	34.G. ...

VARIANT HI

080.9439.04		(1xB)+(6xH)	34.G. ...
080.9625.07		(2xB)+(8xH)	34.G. ...

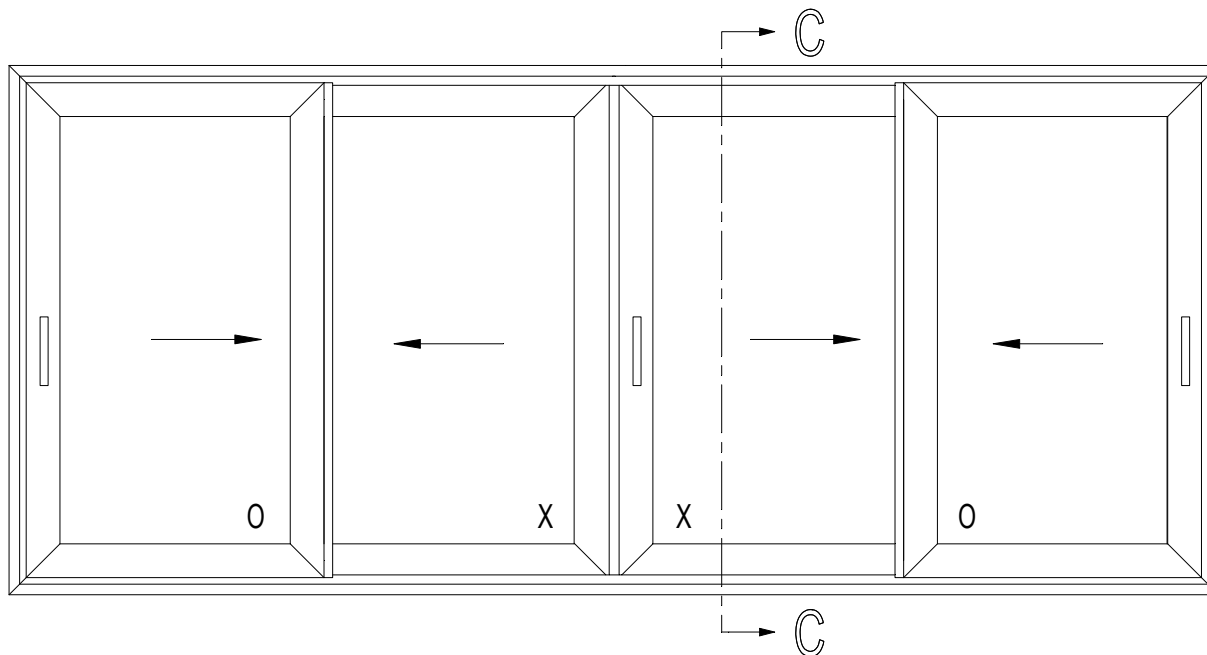

			#	$\leftarrow L_m \rightarrow$		
006.1300.XX			2	B	34.C. ...	bx = (Bx:2)-124.25 hx = H-270
006.1301.04			2	H		
011.4631.--			2	B-116	34.C. ...	bo = Bo-173.5 ho = H-270
006.2340.XX			4	(Bx:2)+41.7	34.C. ...	
			4	Bo-7.5		
			8	H-104		
006.1342.XX			4	H-104	34.C. ...	
006.1341.04			4	H-104	34.C. ...	
006.1343.00			2	H-162	34.C. ...	
006.0335.00			3	280MM	34.C. ...	
				(062.8425.ZC) OF-OU-ODER-OR H-214		
				(062.8426.ZC)		
006.0345.XX			1	H-104	34.C. ...	
030.3614.XX			4	(Bx:2)-112.2	34.C. ...	
			4	Bo-161.5		
			8	H-308		

VLEUGELGEWICHT POIDS DU VANTAIL WEIGHT OF THE VENT FLUEGELGEWICHT	MAX. 250KG
--	------------

schaal - échelle
 scale - Maßstab
 1/2

C - C

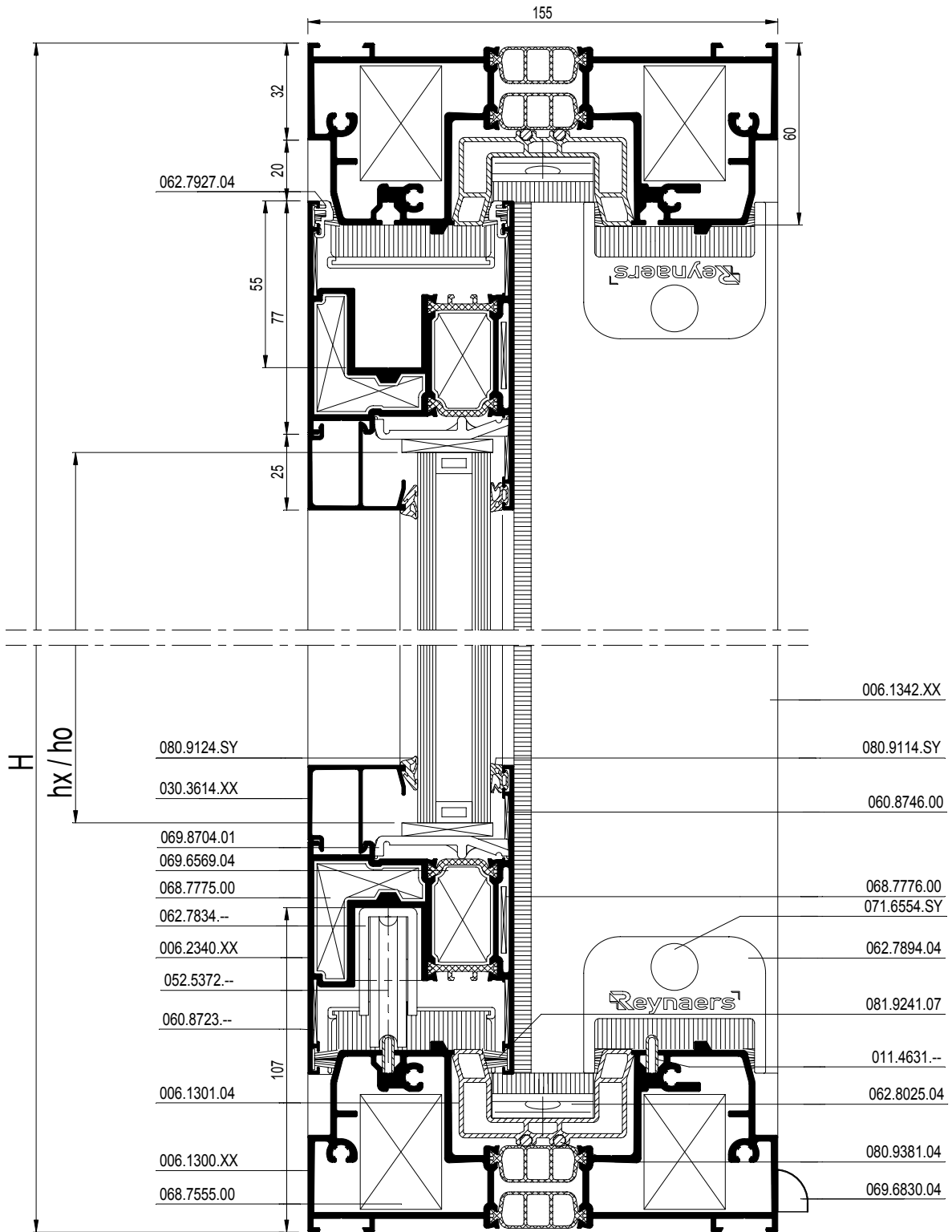

schaal - échelle
 scale - Maßstab
 1/2

D001392

VLEUGELGEWICHT POIDS DU VANTAIL WEIGHT OF THE VENT FLUEGELGEWICHT	MAX. 250KG
--	------------

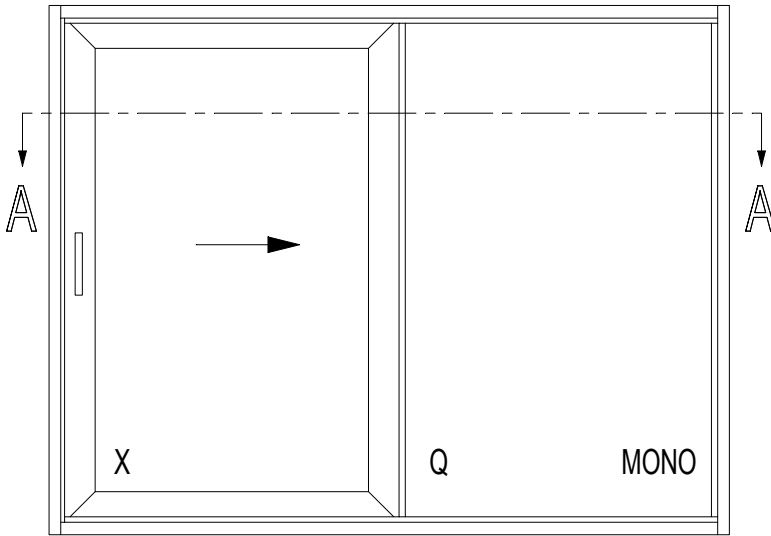

A - A

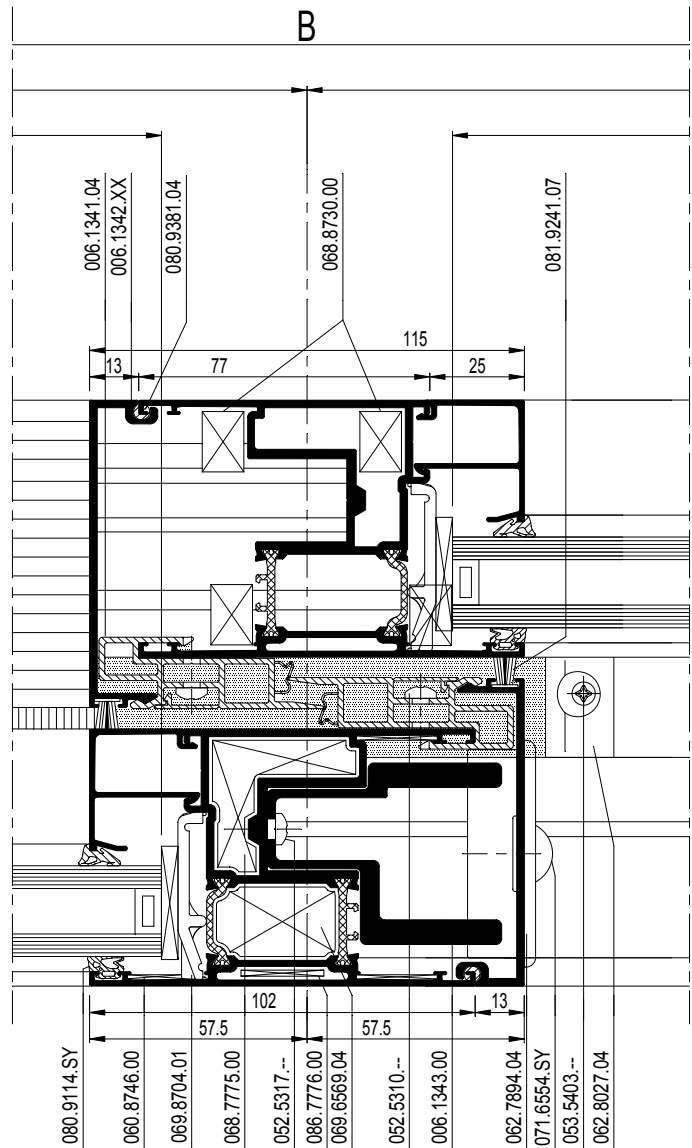
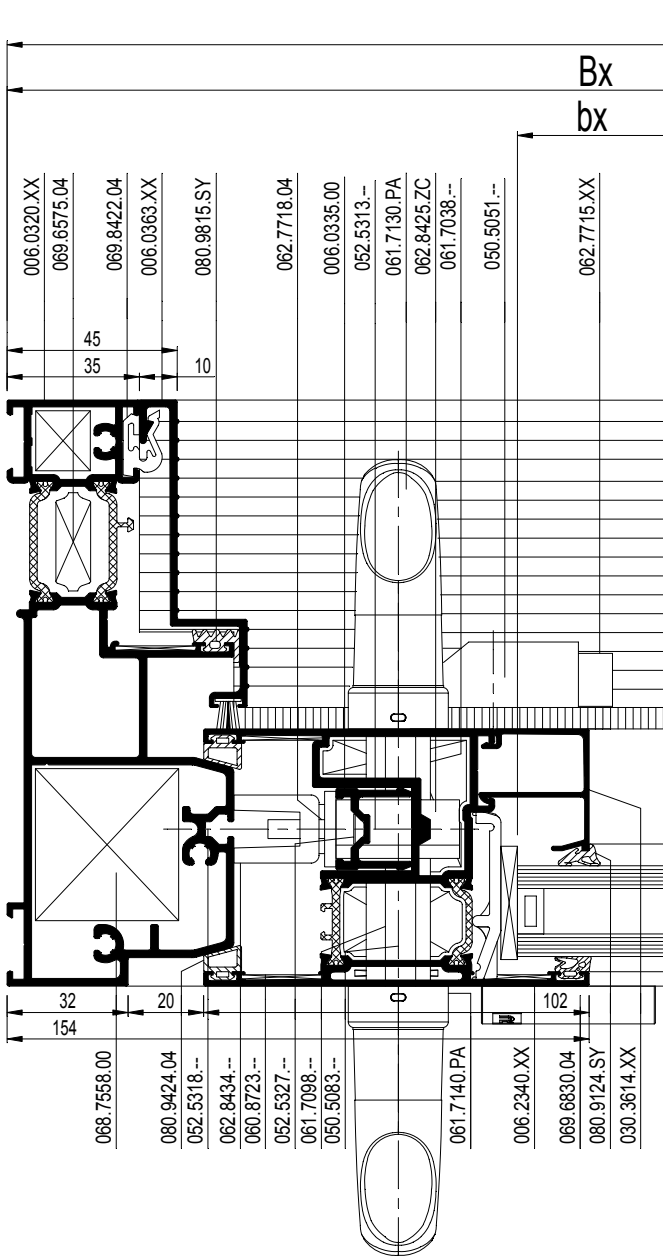

schaal - échelle
 scale - Maßstab
 1/2
 D0013923

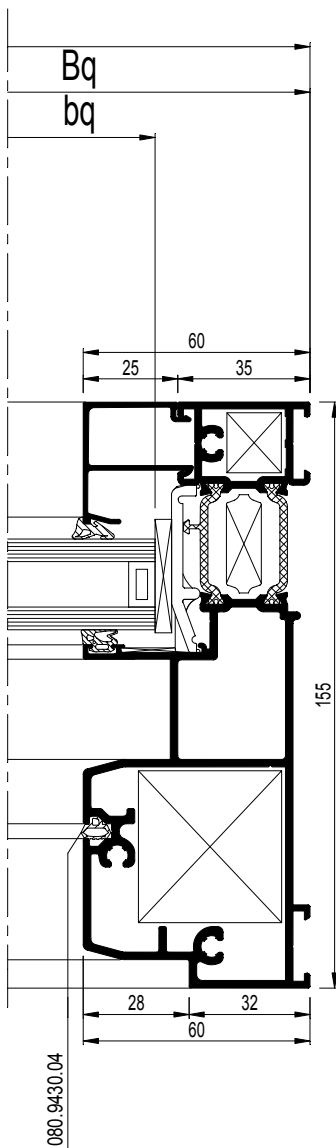

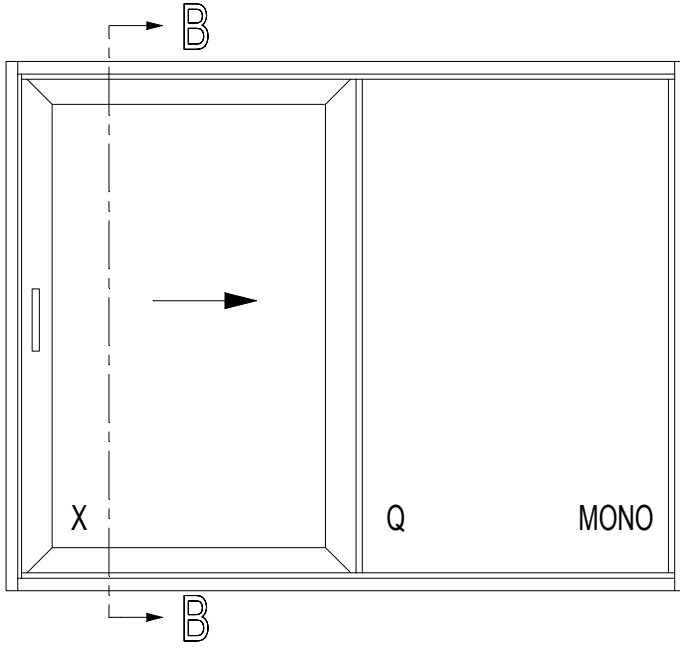

VLEUGELGEWICHT POIDS DU VANTAIL WEIGHT OF THE VENT FLUEGELGEWICHT	MAX. 250KG
--	------------

D0013924

B - B

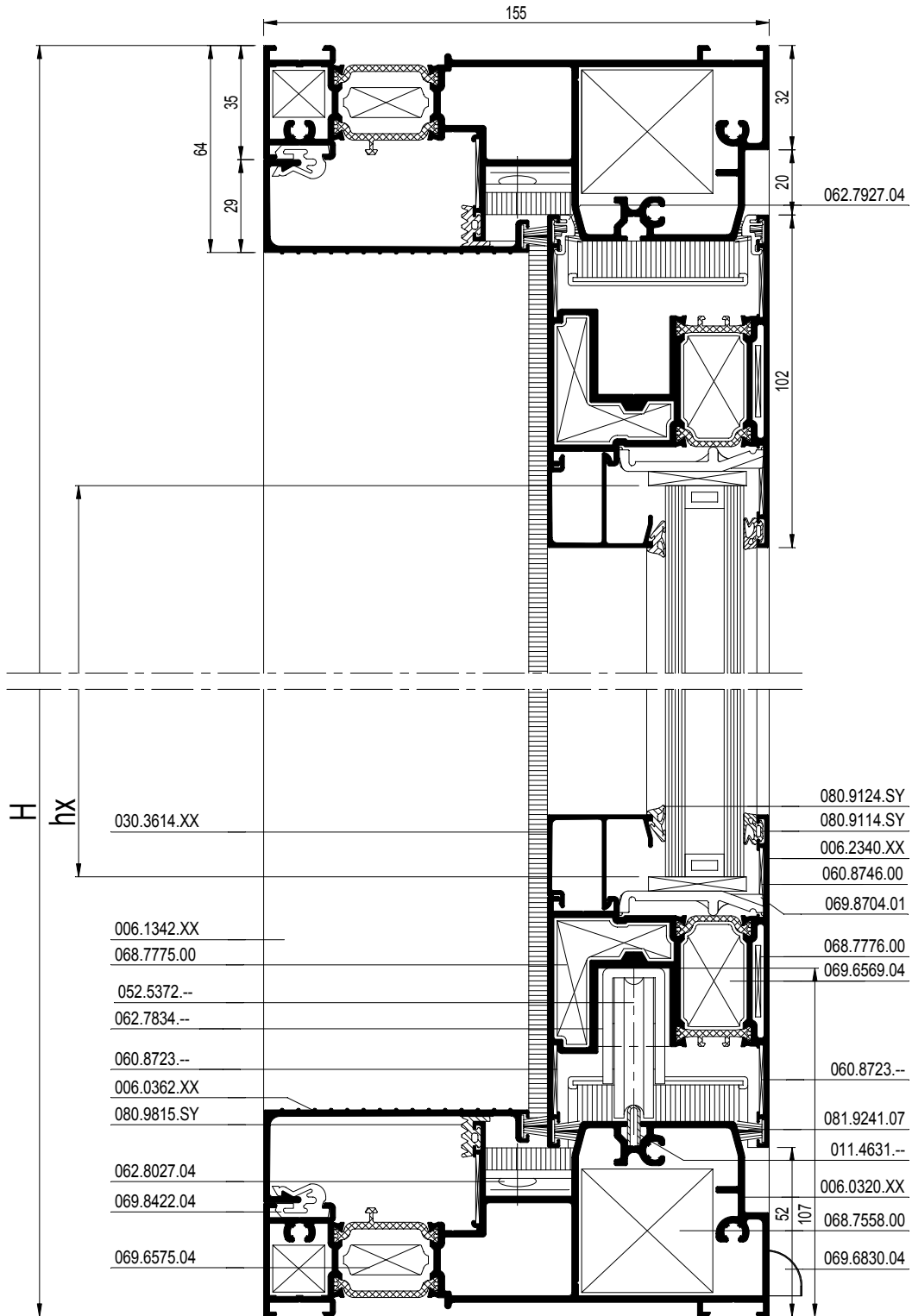

schaal - échelle
 Maßstab - scale
 1/2

D0013924

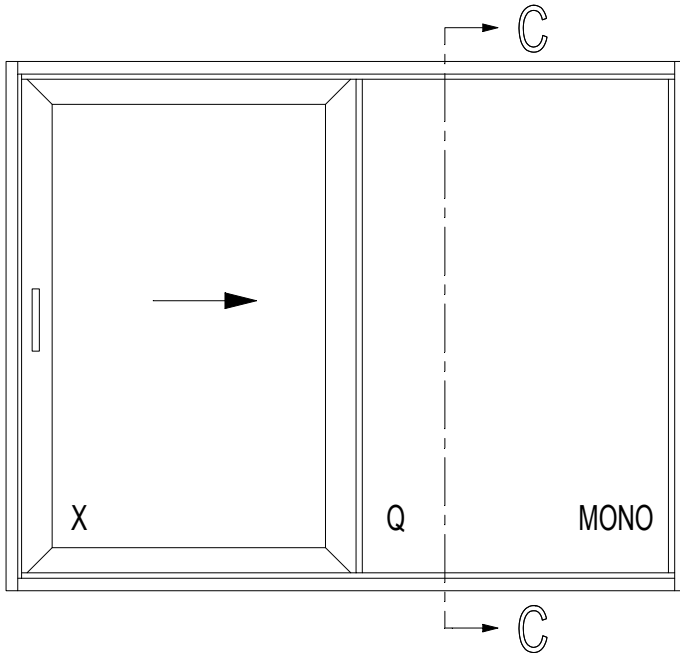

VLEUGELGEWICHT POIDS DU VANTAIL WEIGHT OF THE VENT FLUEGELGEWICHT	MAX. 250KG
--	------------

D00090795

C - C

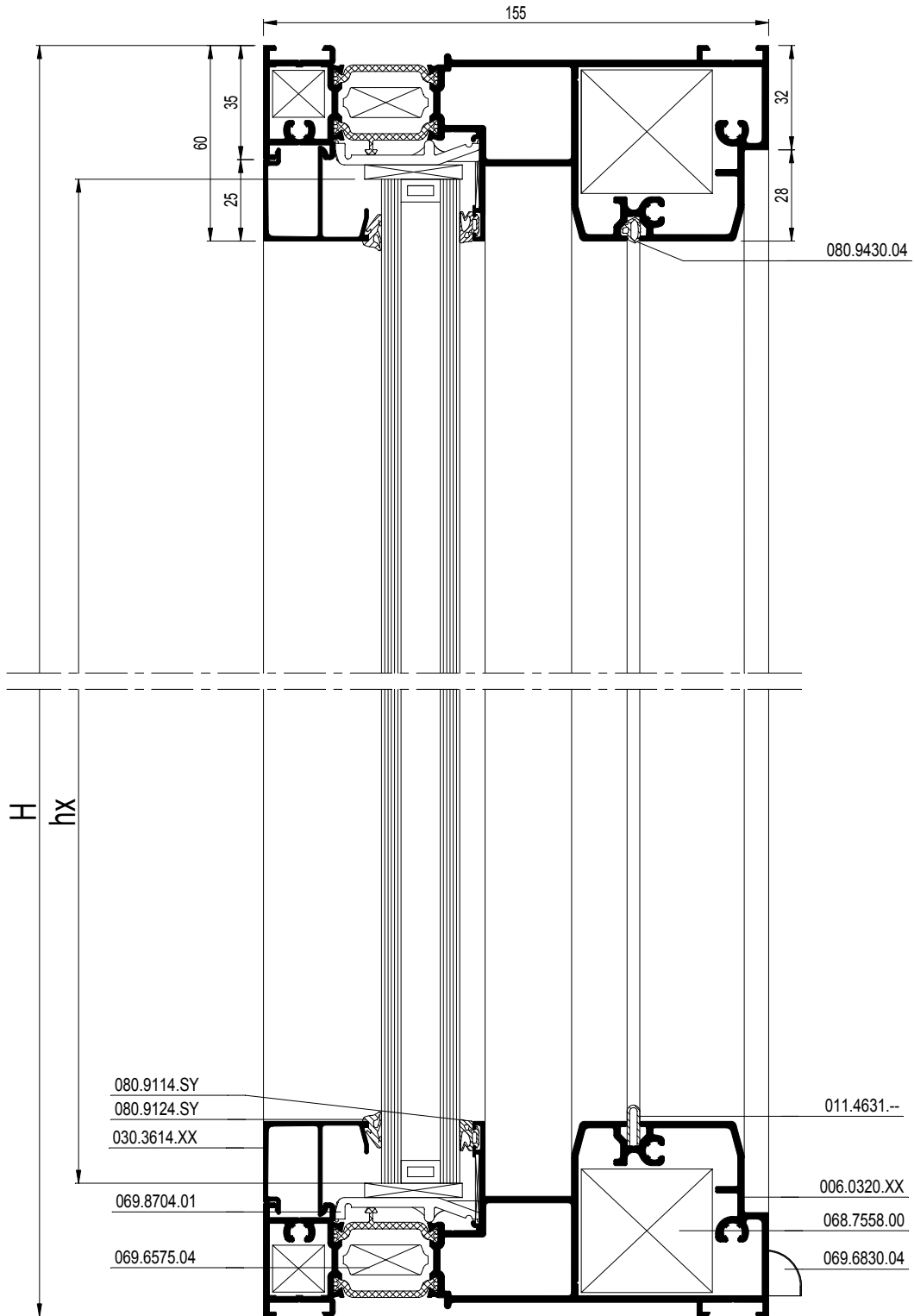

schaal - échelle
 Maßstab - scale
 1/2

D0090795











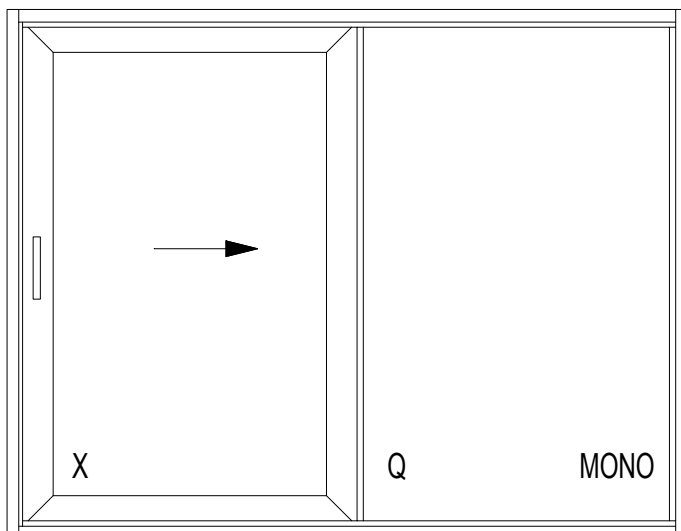

























bx = Bx-173.5

hx = H-270







































bq = Bq-79.5

hq = H-82



			#	$\leftarrow L_m \rightarrow$	
006.0320.XX			2	B	34.C.
			2	H	
011.4631.--			1	B-116	34.C.
006.0362.XX			2	Bx-92.5	34.C.
006.0363.XX			1	H-128	34.C.
006.2340.XX			2	Bx-7.5	34.C.
			2	H-104	
			1	H-70	
006.1342.XX			1	H-104	34.C.
			1	H-70	
006.1341.04			2	H-104	34.C.
006.1343.00			1	H-162	34.C.
006.0335.00			1	280MM	34.C.
			1	(062.8425.ZC) OF-OU-OR-ODER H-214	
				(062.8426.ZC)	
030.3614.XX			2	Bx-161.5	34.C.
			2	H-308	
			2	Bq-67.5	
			2	H-120	



VLEUGELGEWICHT POIDS DU VANTAIL WEIGHT OF THE VENT FLUEGELGEWICHT	MAX. 250KG
--	------------

		#	
068.7558.00		4	34.G.
069.6575.04		4	34.G.
068.7775.00		4	34.G.
069.6569.04		4	34.G.
068.7776.00		4	34.G.
060.8723.--		12	34.G.
060.8746.00		4	34.G.
068.8730.00		4	34.G.
052.5333.--		2	34.G.
050.5153.--		2	34.G.
068.8682.04		4	34.G.
062.7894.04		1	34.G.
052.5317.--		2	34.G.
071.6554.SY		2	34.G.
062.7927.04		min.4	34.G.
062.8425.ZC		1	34.G....
052.5313.--		2	34.G....
062.8434.--		1	34.G....
052.5318.--		3	34.G....
052.5327.--		2	34.G....
062.8426.ZC		1	34.G....
052.5313.--		13	34.G....
062.8440.--		1	34.G....
052.5318.--		12	34.G....
052.5327.--		6	34.G....
062.7718.04		1	34.G.
061.7130.PA		1	34.G. ...
050.5083.--		3	34.G. ...
061.7140.PA		1	34.G.
061.7038.--		1	34.G.
061.7098.--		1	34.G.
062.7715.XX		1	34.G.
050.5051.--		1	34.G.
062.7834.--		2	34.G.
052.5372.--		4	34.G.

(*)

		#	
062.8027.04		1	34.G.
053.5403.--		4	34.G.
052.5310.--		2xH (3/m)	34.G.
052.5317.--		H (3/m)	34.G.
069.8704.01		16	34.G.
069.8422.04		2xBx(3/m)+H(3/m)	34.G.
069.6830.04		min. 2	34.G.
069.6747.04		2	34.G.
080.9124.SY		(2xB)+(4xH)	34.G.
080.9114.SY		(2xB)+(4xH)	34.G.
080.9424.04		2xH	34.G.
080.9430.04		H	34.G.
080.9815.SY		B+H	34.G.
080.9381.04		2xH	34.G.
081.9241.07		6Bx+(3xH)	34.G.

VARIANT HI

080.9439.04		Bx+(2xH)	34.G. ...
080.9625.07		(2xB)+(4xH)	34.G. ...

(*) Afhankelijk van de hoogte
Dépend de l'hauteur
Dependent of the height
Von der Höhe abhängig

D0090577

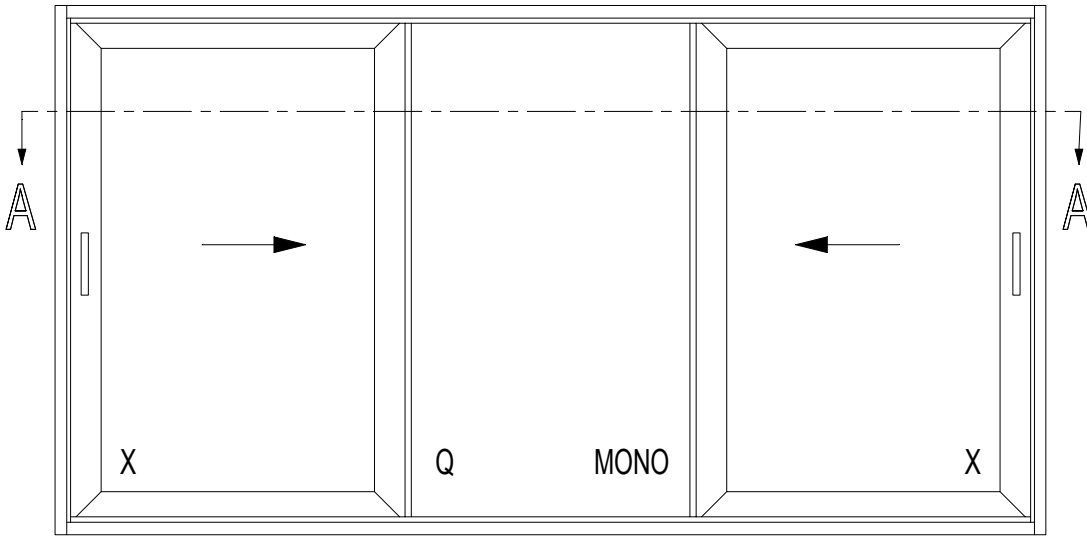

A - A

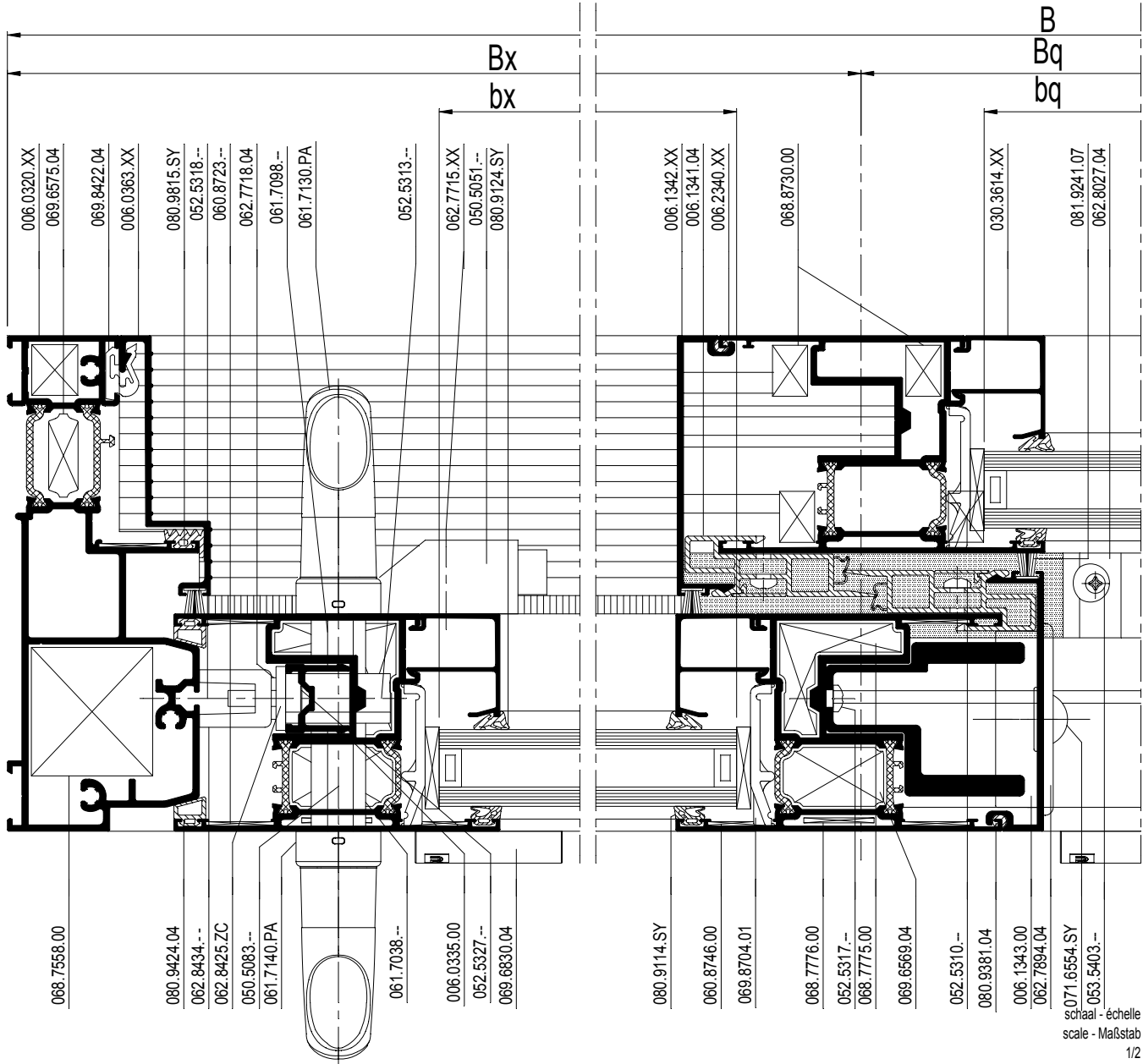

schaal - échelle
 scale - Maßstab
 1/2
 D0013925

VLEUGELGEWICHT POIDS DU VANTAIL WEIGHT OF THE VENT FLUEGELGEWICHT	MAX. 250KG
--	------------

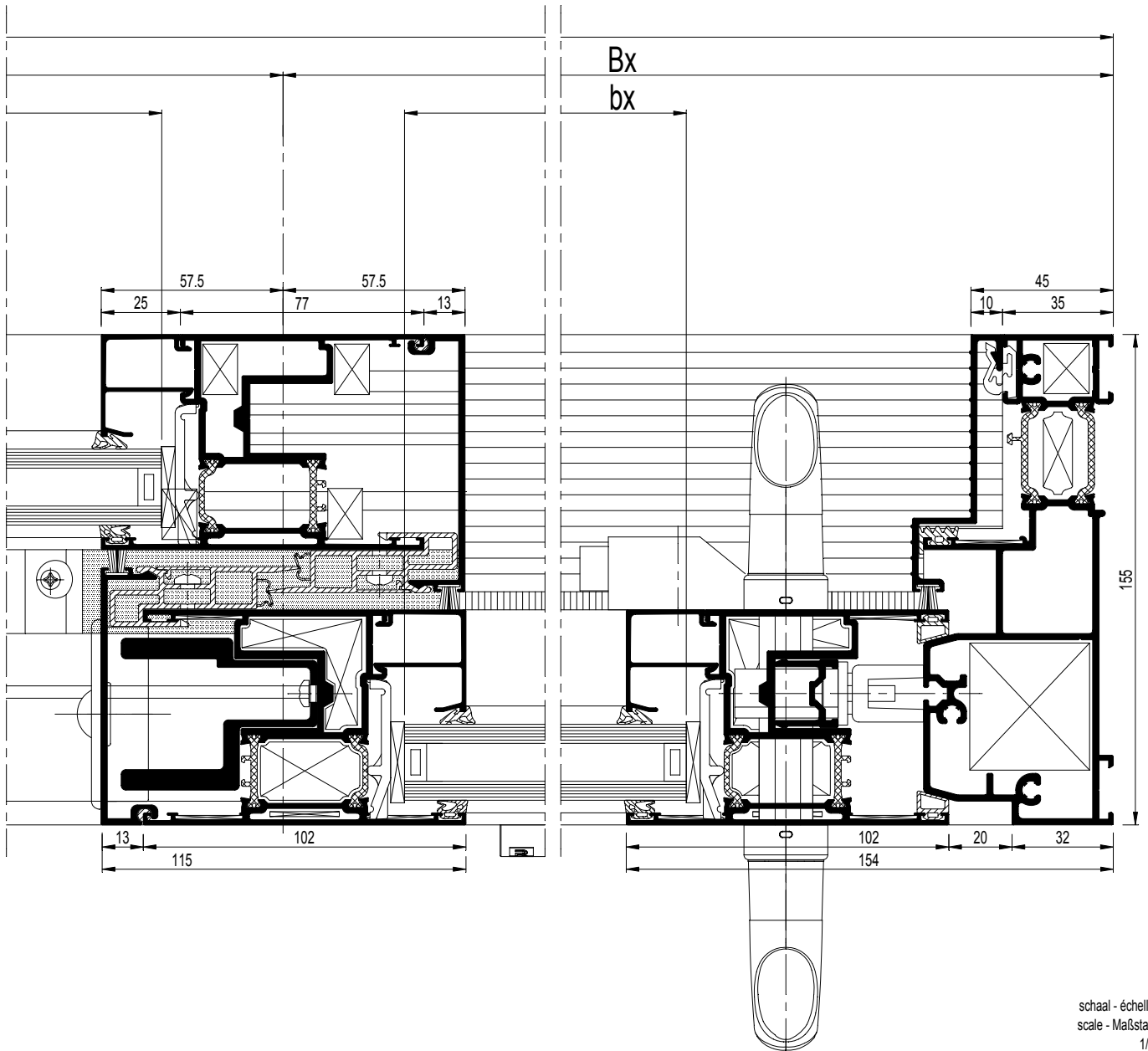

schaal - échelle
 scale - Maßstab
 1/2

D0013925

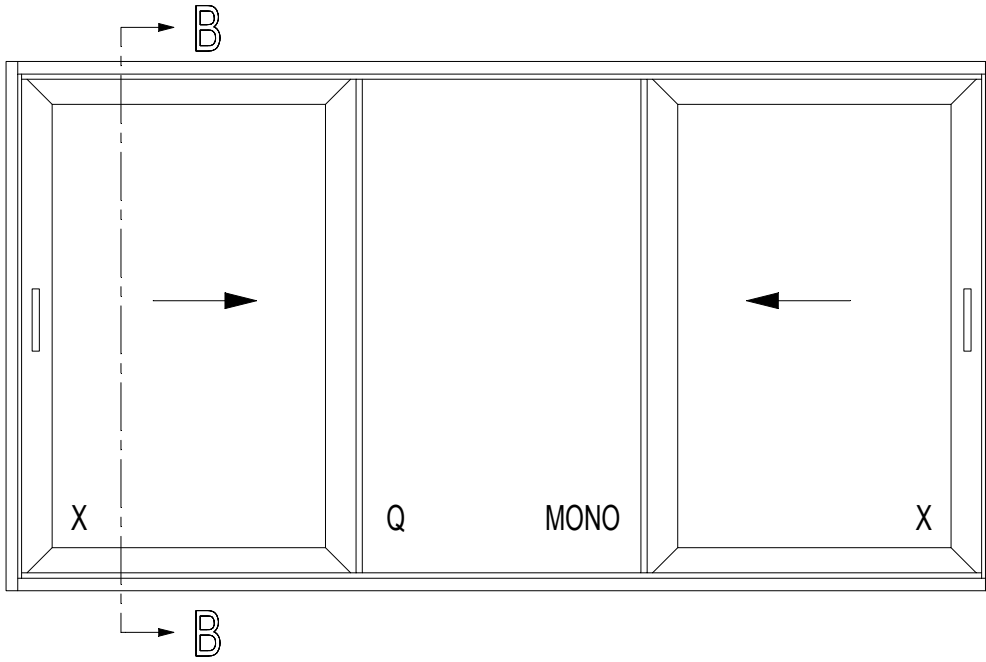

VLEUGELGEWICHT POIDS DU VANTAIL WEIGHT OF THE VENT FLUEGELGEWICHT	MAX. 250KG
--	------------

B - B

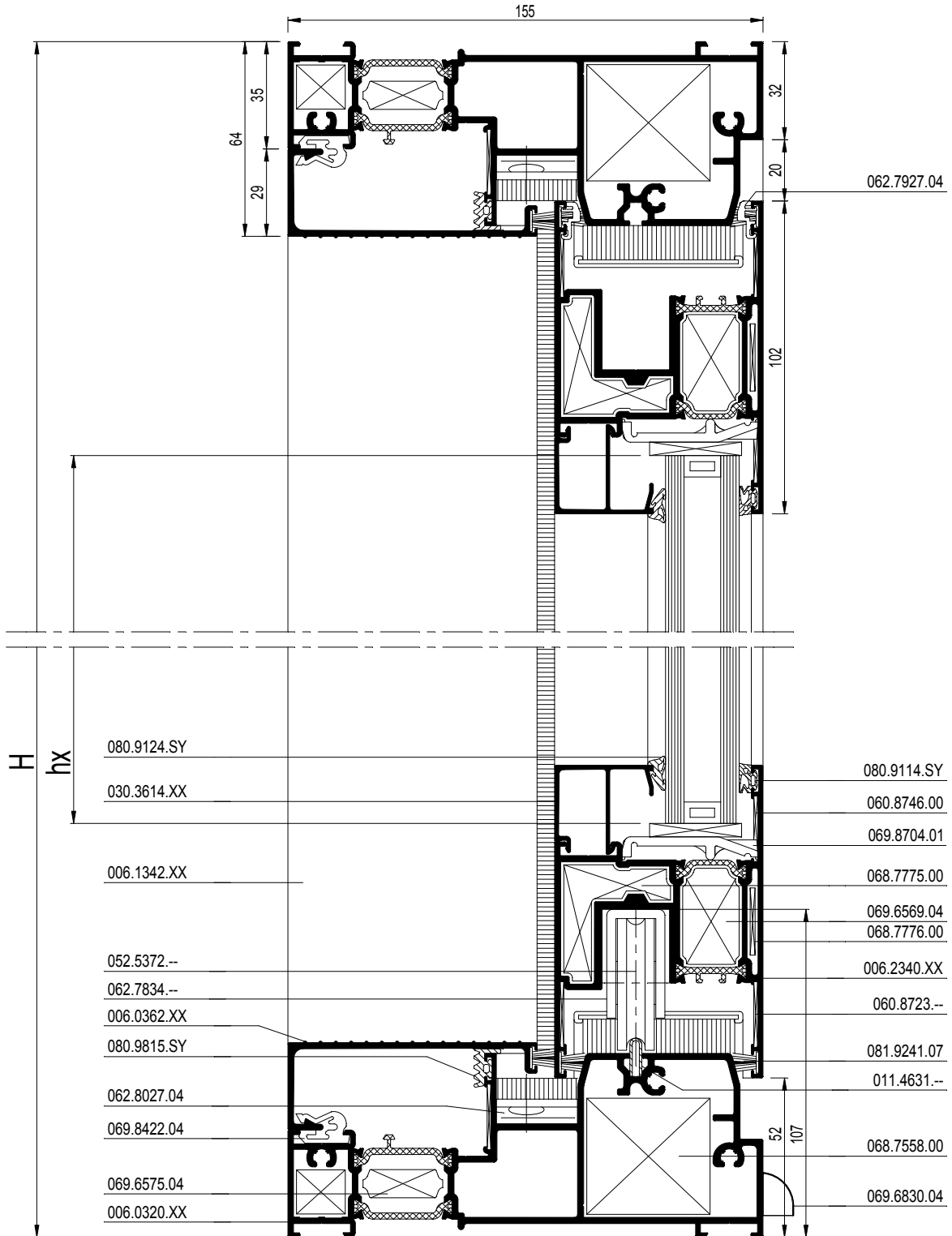





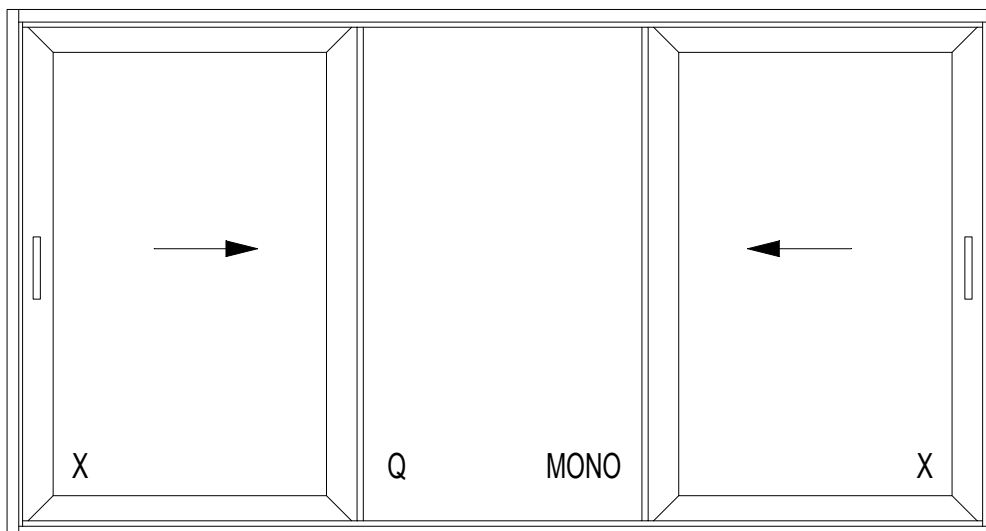





























schaal - échelle
 scale - Maßstab
 1/2

D0013926



			#	$\leftarrow L_m \rightarrow$		
006.0320.XX			2	B	34.C. ...	bx = Bx-173.5
			2	H		
011.4631.--			1	B-116	34.C. ...	hx = H-270
006.0362.XX			4	Bx-92.5	34.C. ...	bq = Bq-77
006.0363.XX			2	H-128	34.C. ...	hq = H-82
006.2340.XX			4	Bx-7.5	34.C. ...	
			4	H-104		
			2	H-70		
006.1342.XX			2	H-104	34.C. ...	
			2	H-70		
006.1341.04			4	H-104	34.C. ...	
006.1343.00			2	H-162	34.C. ...	
006.0335.00			2	280MM	34.C. ...	
				(062.8425.ZC)		
			2	H-214 <small>OF-OU-OR-ORDER</small>		
030.3614.XX			4	Bx-161.5	34.C. ...	
			2	Bq-65		
			4	H-308		
			2	H-120		

VLEUGELGEWICHT POIDS DU VANTAIL WEIGHT OF THE VENT FLUEGELGEWICHT	MAX. 250KG
--	------------



		#	
068.7558.00		4	34.G. ...
069.6575.04		4	34.G. ...
068.7775.00		8	34.G. ...
069.6569.04		8	34.G. ...
068.7776.00		8	34.G. ...
060.8723.--		20	34.G. ...
060.8746.00		8	34.G. ...
068.8730.00		8	34.G.
052.5333.--		4	34.G.
050.5153.--		4	34.G.
068.8682.04		8	34.G.
062.7894.04		2	34.G. ...
052.5317.--		4	34.G. ...
071.6554.SY		4	34.G. ...
062.7927.04		min.8	34.G. ...
062.8425.ZC		2	34.G....
052.5313.--		4	34.G....
062.8434.--		2	34.G....
052.5318.--		6	34.G....
052.5327.--		4	34.G....
062.8426.ZC		2	34.G....
052.5313.--		26	34.G....
062.8440.--		2	34.G....
052.5318.--		24	34.G....
052.5327.--		12	34.G....
062.7718.04		2	34.G. ...
061.7130.PA		2	34.G. ...
050.5083.--		6	34.G. ...
061.7140.PA		2	34.G. ...
061.7038.--		2	34.G. ...
061.7098.--		2	34.G.

(*)

(*) Afhankelijk van de hoogte
Dépend de l'hauteur
Dependent of the height
Von der Höhe abhängig

		#	
062.7715.XX		2	34.G. ...
050.5051.--		2	34.G. ...
062.7834.--		4	34.G. ...
052.5372.--		8	34.G. ...
062.8027.04		2	34.G. ...
053.5403.--		8	34.G. ...
052.5310.--		4xH (3/m)	34.G. ...
052.5317.--		2xH (3/m)+4	34.G. ...
069.8704.01		24	34.G. ...
069.8422.04		4xBx(3/m)+2xH(3/m)	34.G.
069.6830.04		min. 2	34.G. ...
069.6747.04		4	34.G. ...
080.9124.SY		(2xB)+(6xH)	34.G. ...
080.9114.SY		(2xB)+(6xH)	34.G. ...
080.9424.04		4xH	34.G. ...
080.9815.SY		(4xBx)+(2xH)	34.G. ...
080.9381.04		4xH	34.G. ...
081.9241.07		(12xBx)+(6xH)	34.G. ...

VARIANT HI

080.9439.04		(2xBx)+(4xH)	34.G. ...
080.9625.07		(2xB)+(6xH)	34.G. ...

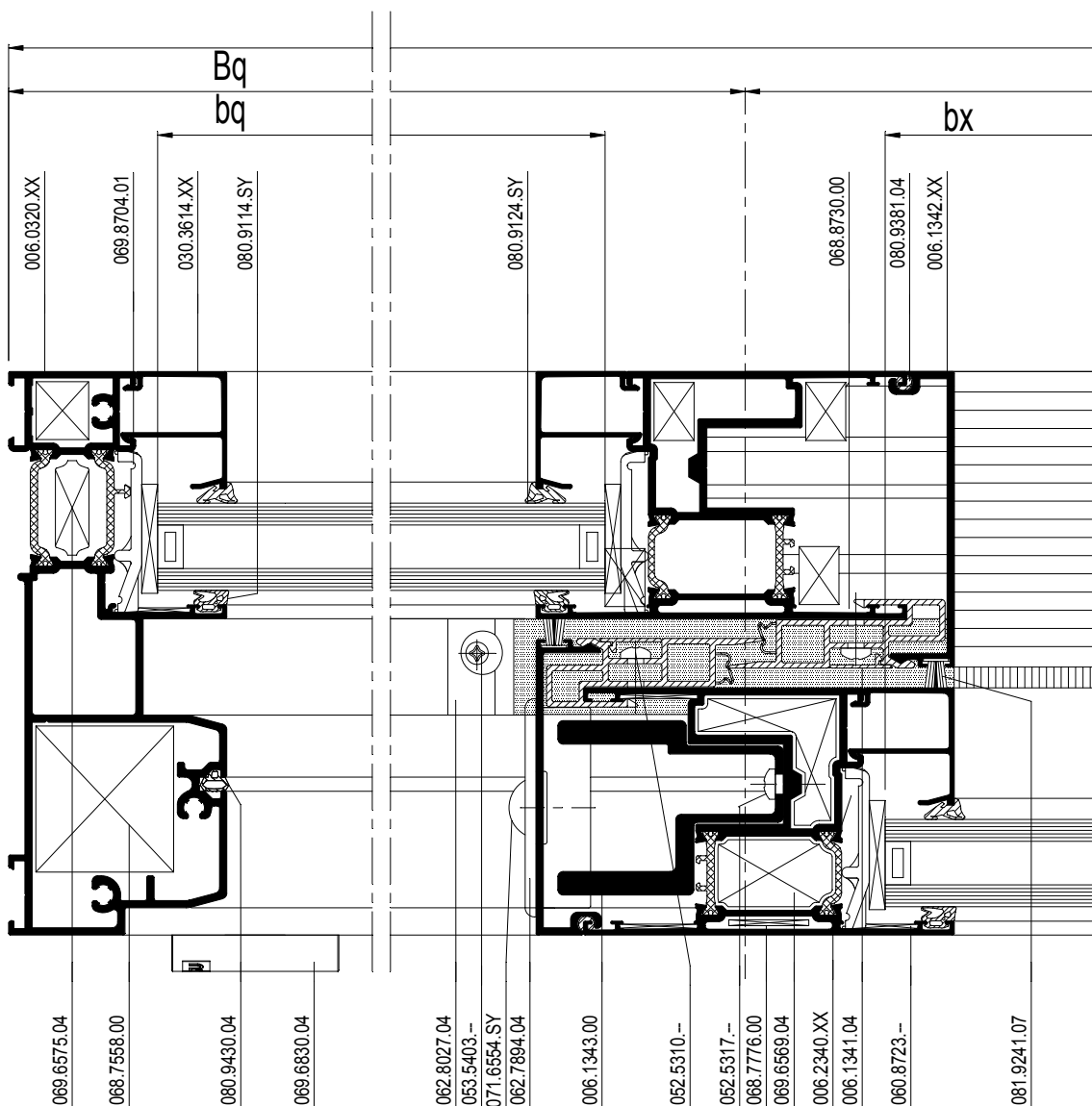
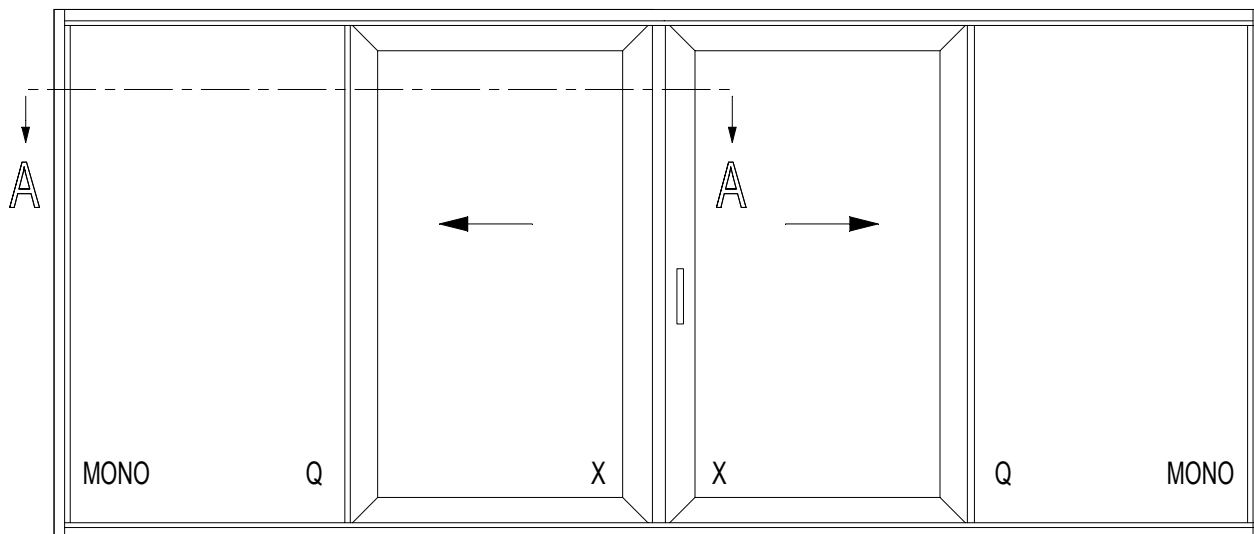

schaal - échelle
 scale - Maßstab
 1/2
 D0013927

VLEUGELGEWICHT POIDS DU VANTAIL WEIGHT OF THE VENT FLUEGELGEWICHT	MAX. 250KG
--	------------

A - A

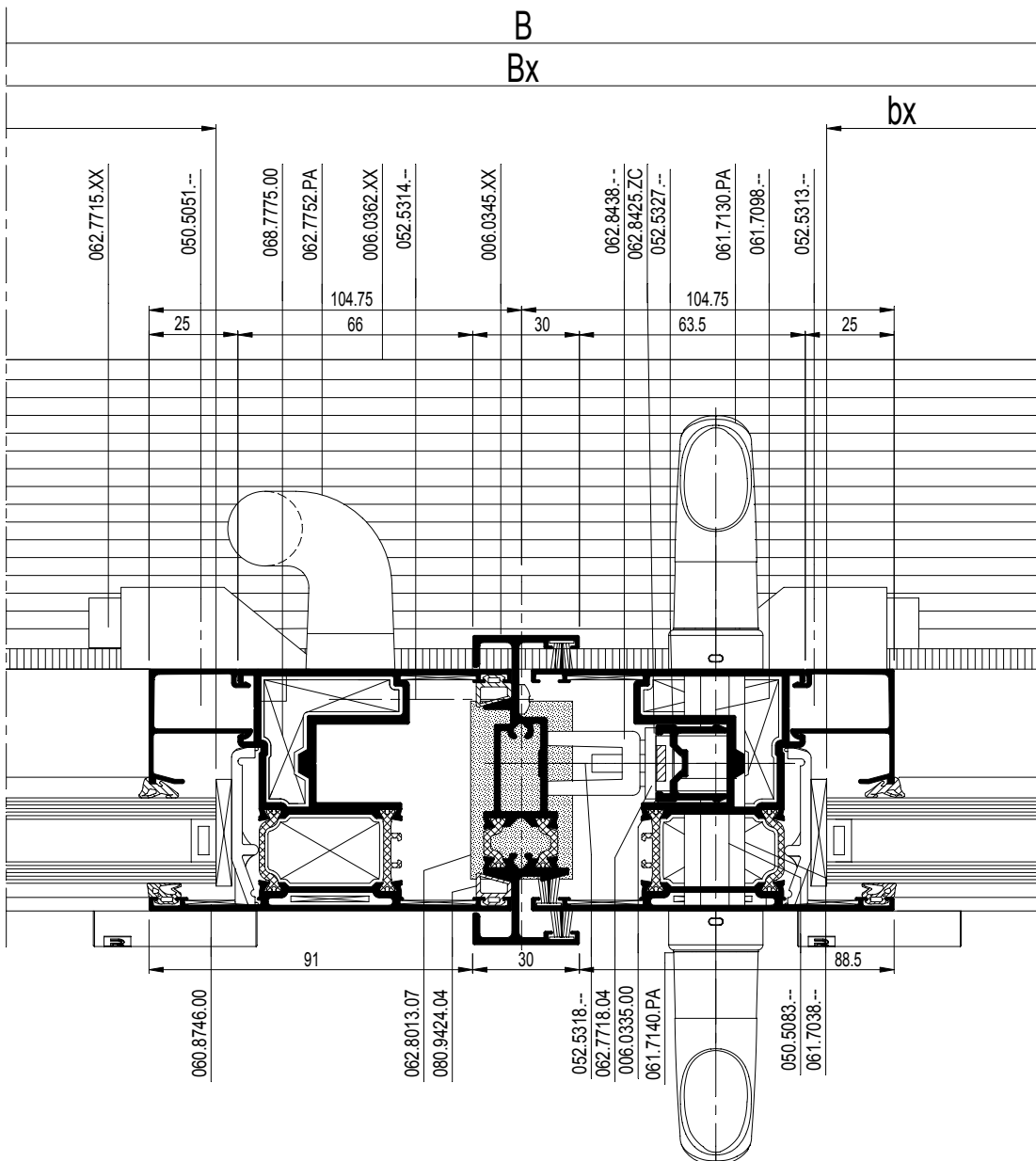





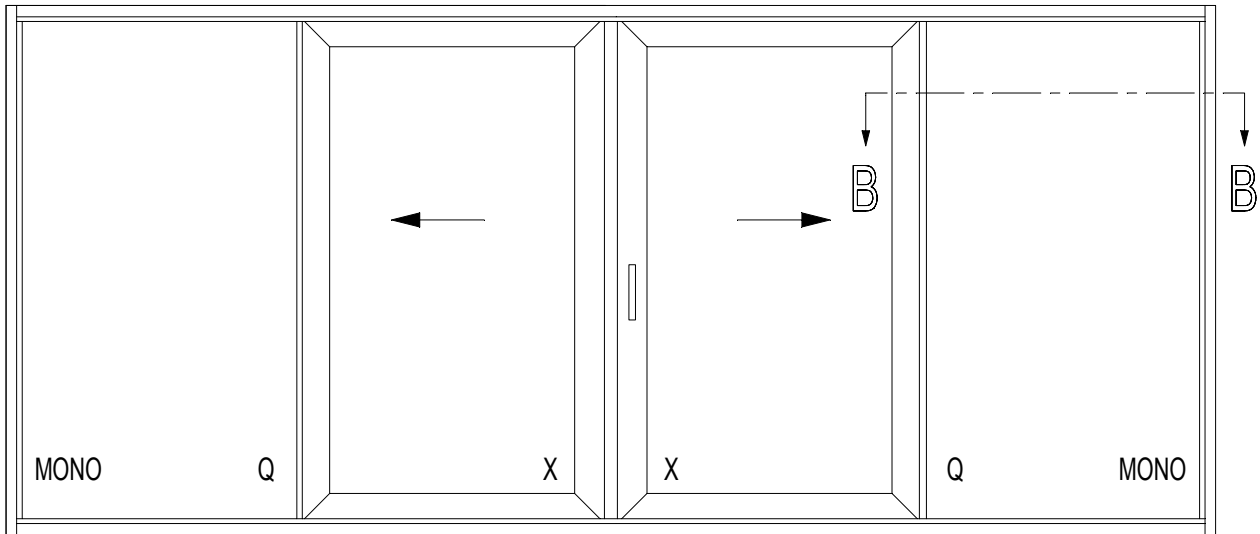



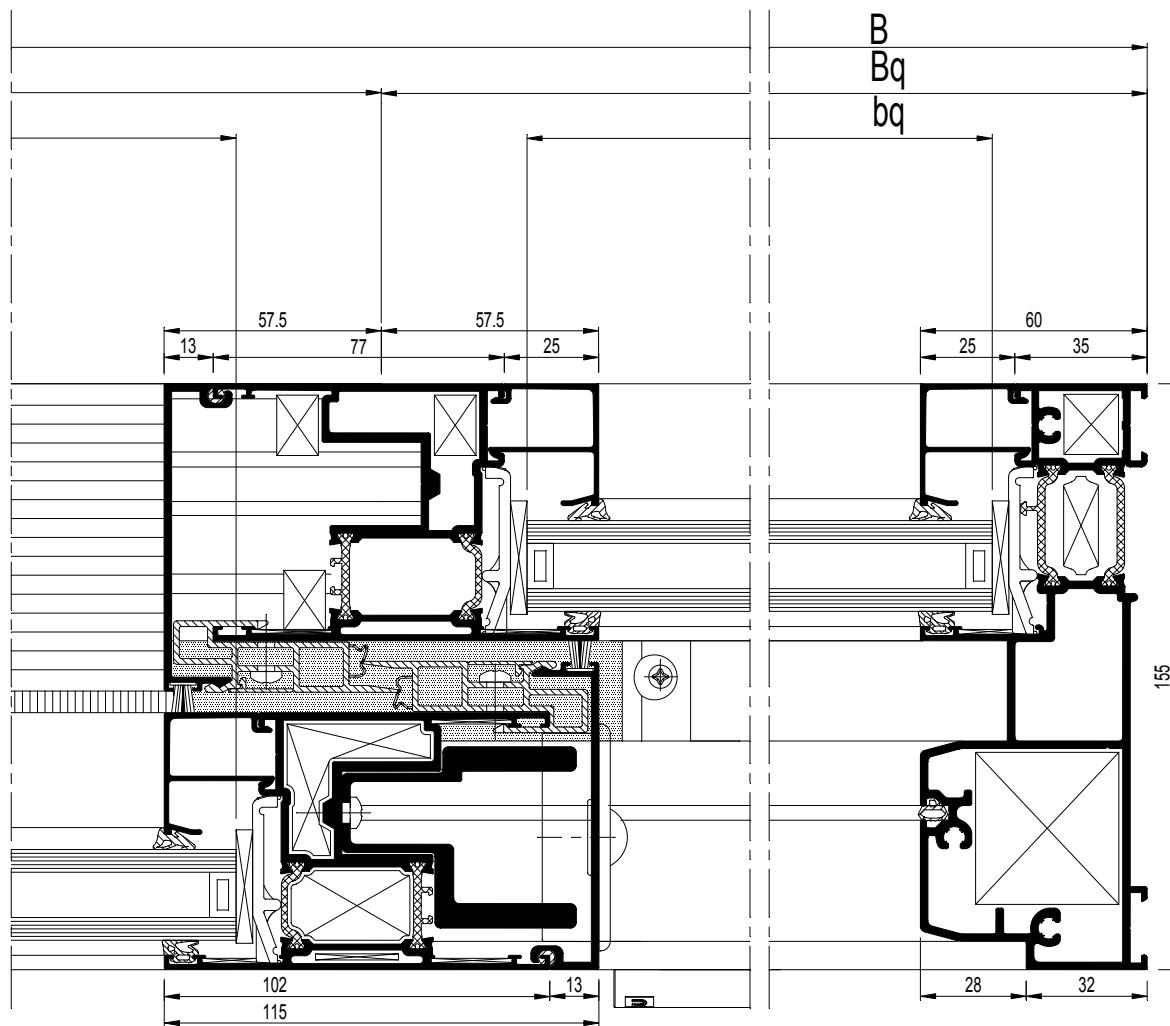

















schaal - échelle
 scale - Maßstab
 1/2

D0013927



















B - B





		#	
068.7558.00		4	34.G.
069.6575.04		4	34.G.
068.7775.00		8	34.G.
069.6569.04		8	34.G.
068.7776.00		8	34.G.
060.8723.--		20	34.G.
060.8746.00		8	34.G. ...
068.8730.00		8	34.G.
052.5333.--		4	34.G.
050.5153.--		4	34.G.
068.8682.04		8	34.G.
062.7894.04		2	34.G.
052.5317.--		4	34.G.
071.6554.SY		4	34.G.
062.7927.04		min.8	34.G.
062.8425.ZC		1	34.G....
052.5313.--		2	34.G....
062.8438.--		1	34.G....
052.5318.--		2	34.G....
052.5327.--		2	34.G....
062.8426.ZC		1	34.G....
052.5313.--		13	34.G....
062.8441.--		1	34.G....
052.5318.--		12	34.G....
062.5320.PA		6	34.G....
060.5088.04		3	34.G....
061.7140.PA		1	34.G.
061.7038.--		1	34.G.
061.7098.--		1	34.G.
062.7752.PA		1	34.G. ...
057.5711.--		2	34.G. ...
050.5011.--		2	34.G. ...
062.7834.--		4	34.G.
052.5372.--		8	34.G.
062.8027.04		2	34.G.
053.5403.--		8	34.G.
062.7715.XX		2	34.G.
050.5051.--		2	34.G.
062.8013.07		1	34.G.
052.5310.--		4	34.G.

(*)

		#	
052.5310.--		4xH (3/m)	34.G.
052.5317.--		2xH (3/m)+2	34.G.
052.5314.--		H (3/m)	34.G.
069.8704.01		32	34.G.
069.8422.04		2xBx (3/m)	34.G.
069.6830.04		min. 2	34.G.
069.6747.04		4	34.G.
080.9124.SY		(2xB)+(8xH)	34.G.
080.9114.SY		(2xB)+(8xH)	34.G.
080.9424.04		2xH	34.G.
080.9815.SY		2xBx	34.G.
080.9430.04		2XH	34.G.
080.9381.04		4XH	34.G.
081.9241.07		(6xBx)+(7xH)	34.G.

VARIANT HI









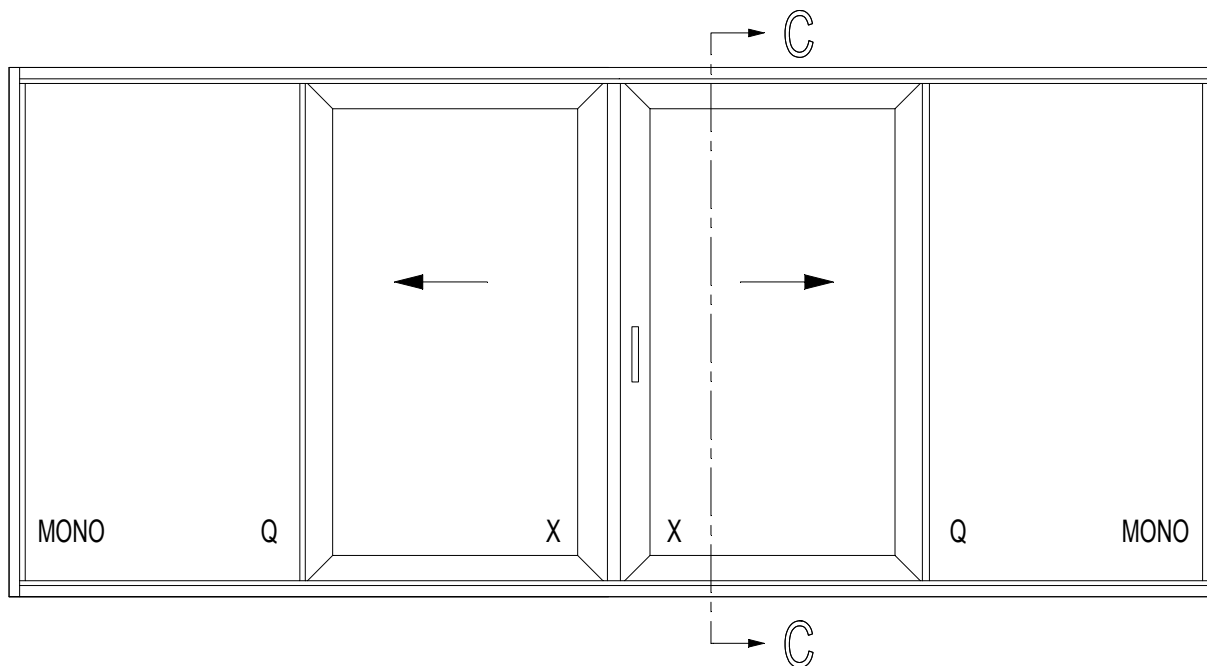























080.9439.04		Bx+(4xH)	34.G. ...
080.9625.07		(2xB)+(8xH)	34.G. ...

VLEUGELGEWICHT POIDS DU VANTAIL WEIGHT OF THE VENT FLUEGELGEWICHT	MAX. 250KG
--	------------

(*) Afhankelijk van de hoogte
Dépend de l'hauteur
Dependent of the height
Von der Höhe abhängig

D0013928



			#	$\leftarrow L_m \rightarrow$		
006.0320.XX			2	B	34.C. ...	bx = (Bx:2)-124.5 hx = H-270 bq = Bq-79.5 hq = H-82
011.4631.--			1	B-116	34.C. ...	
006.0362.XX			2	Bx-115	34.C. ...	
006.2340.XX			4	(Bx:2)+41.7	34.C. ...	
			4	H-104		
			2	H-70		
006.1342.XX			2	H-104	34.C. ...	
			2	H-70		
006.1341.04			4	H-104	34.C. ...	
006.1343.00			2	H-162	34.C. ...	
006.0335.00			1	280MM	34.C. ...	
				(062.8425.ZC)		
			1	H-214		
				(062.8426.ZC)		
006.0345.XX			1	H-104	34.C. ...	
030.3614.XX			4	(Bx:2)-112.2	34.C. ...	
			4	H-308		
			4	Bq-67.5		
			4	H-120		

VLEUGELGEWICHT POIDS DU VANTAIL WEIGHT OF THE VENT FLUEGELGEWICHT	MAX. 250KG
--	------------

C - C

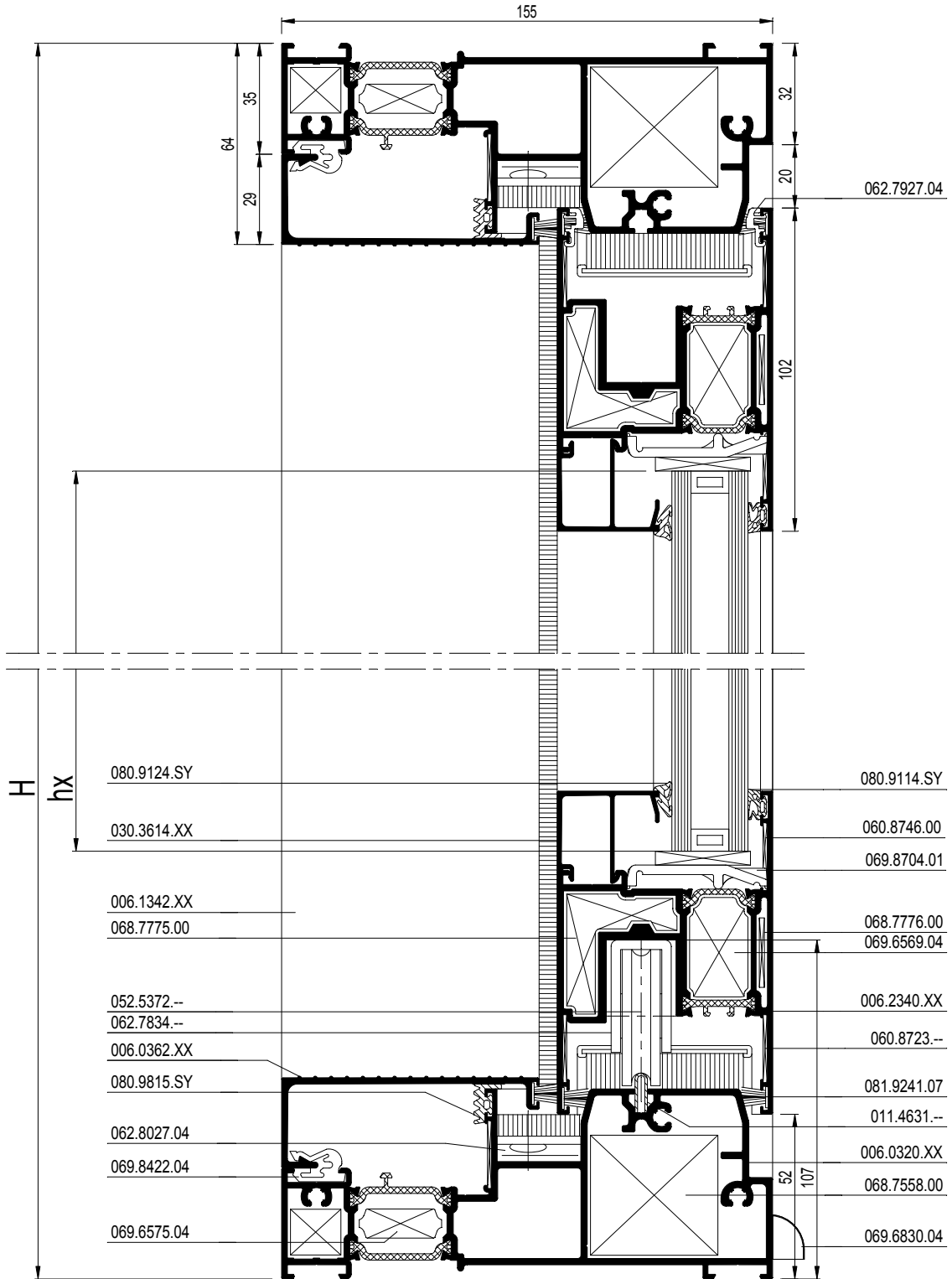

VLEUGELGEWICHT POIDS DU VANTAIL WEIGHT OF THE VENT FLUEGELGEWICHT	MAX. 250KG
--	------------

A - A

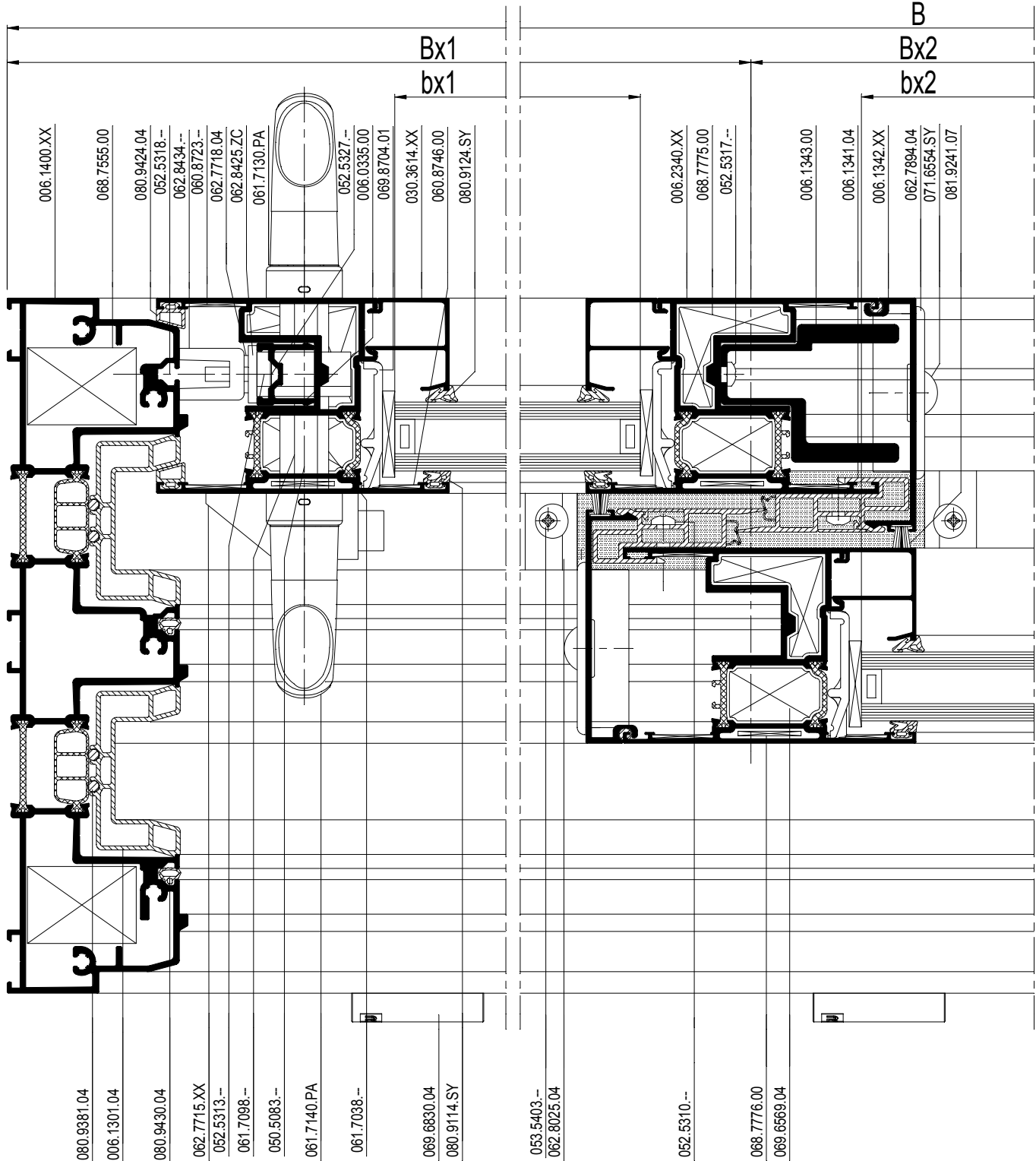

schaal - échelle
 scale - Maßstab
 1/2
 D0084693

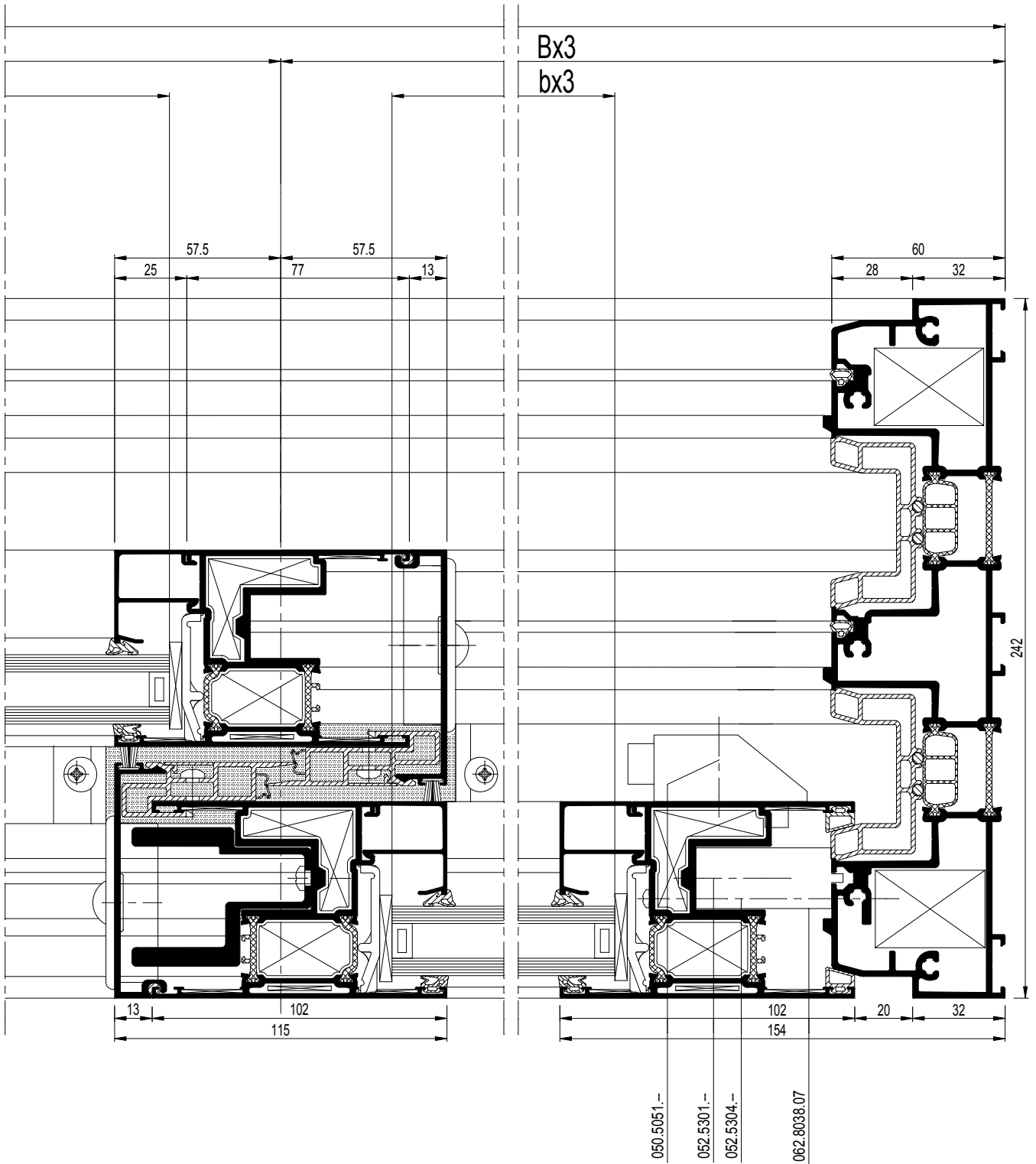

schaal - échelle
 scale - Maßstab
 1/2

D0084693

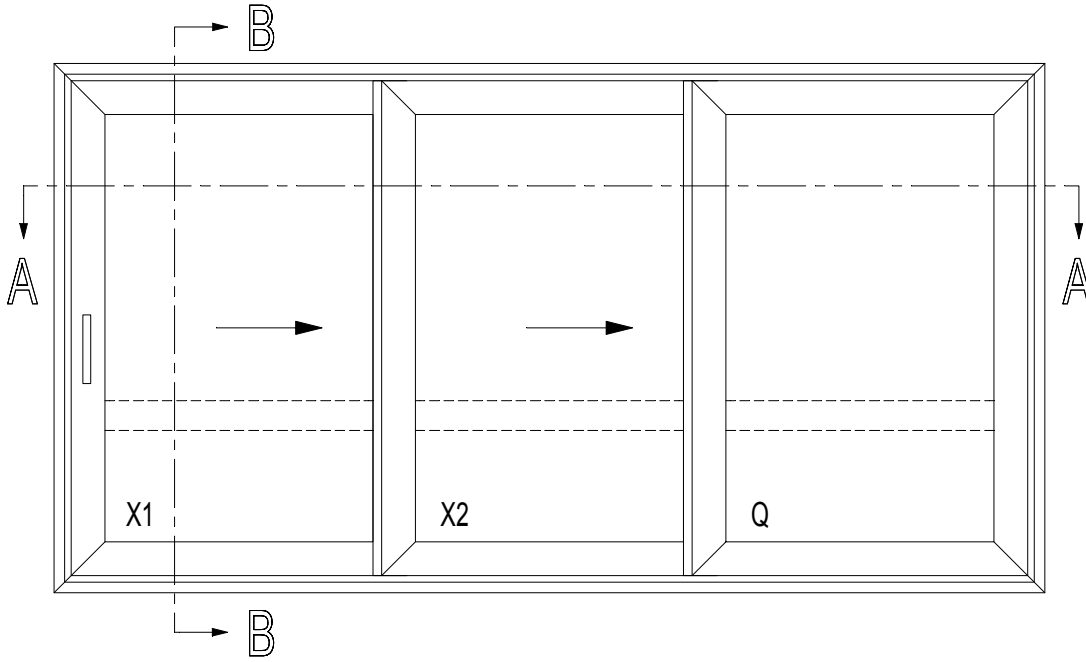







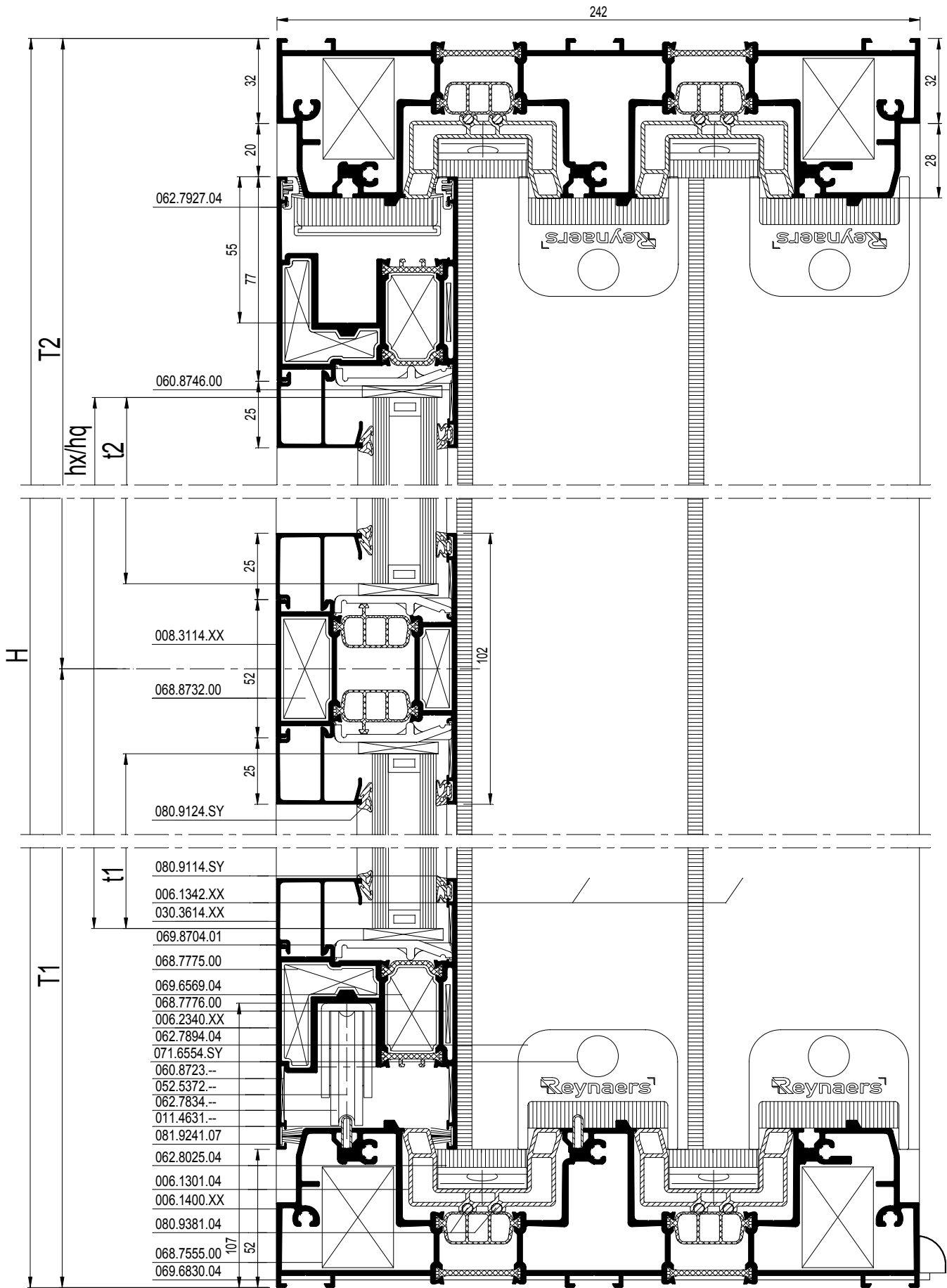

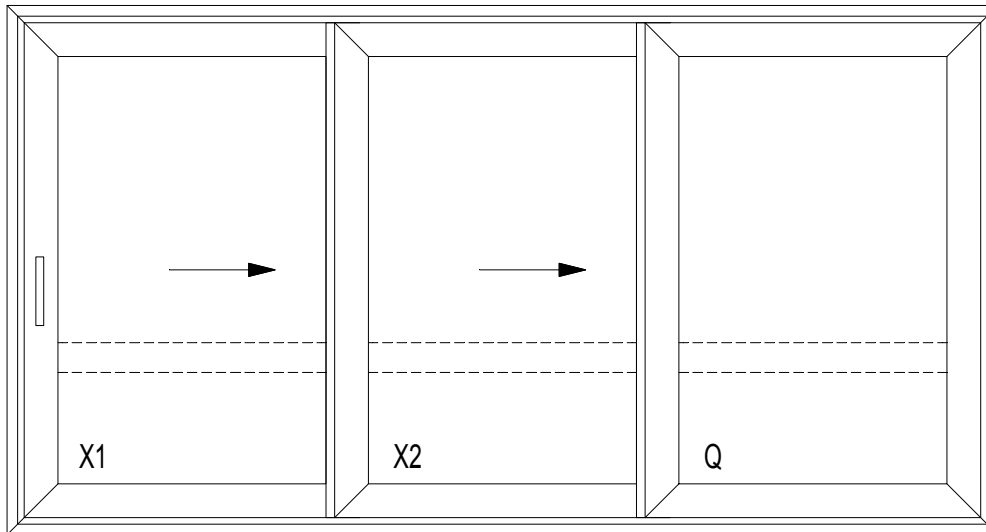













VLEUGELGEWICHT POIDS DU VANTAIL WEIGHT OF THE VENT FLUEGELGEWICHT	MAX. 250KG
--	------------

HOOGTE HAUTEUR HEIGHT HOEHE	MIN. 1895 MM
--------------------------------------	--------------



B - B





			#	$\leftarrow L_m \rightarrow$	
006.1400.XX			2	B	34.C. ...
			2	H	
006.1301.04			4	B	34.C. ...
			4	H	
011.4631.--			2	B-116	34.C. ...
006.2340.XX			2	Bx1-7.5	34.C. ...
			2	Bx2+89	
			2	Bq-7.5	
			6	H-104	
006.1342.XX			4	H-104	34.C. ...
006.1341.04			4	H-104	34.C. ...
006.1343.XX			2	H-162	34.C. ...
006.0335.00			1	280MM	34.C. ...
				(062.8425.ZC) <small>OF-DU-OPROEFEN</small>	
			1	H-214	
				(062.8426.ZC)	
030.3614.XX			2	Bx1-161.5	34.C. ...
			2	Bx2-65	
			2	Bq-161.5	
			6	H-308	

met dwarsstijl
 avec traverse
 with transom
 mit Sprossenprofil
 +

008.3114.XX			1	Bx1-161.5	34.C. ...
			1	Bx2-65	
			1	Bq-161.5	

VLEUGELGEWICHT POIDS DU VANTAIL WEIGHT OF THE VENT FLUEGELGEWICHT	MAX. 250KG
--	------------

HOOGTE HAUTEUR HEIGHT HOEHE	MIN. 1895 MM
--------------------------------------	--------------

D0084695

			#	
bx1=Bx1-173.5	068.7555.00		8	34.G. ...
hx/hq=H-270	068.7775.00		12	34.G. ...
bx2=Bx2-77	069.6569.04		12	34.G. ...
bq=Bq-173.5	068.7776.00		12	34.G. ...
	060.8723.--		24	34.G. ...
	060.8746.00		12	34.G. ...
	062.7894.04		4	34.G. ...
	052.5317.--		8	34.G. ...
	071.6554.SY		8	34.G. ...
	062.7927.04		min.12	34.G. ...
	062.8425.ZC		1	34.G. ...
	052.5313.--		2	34.G. ...
	062.8434.--		1	34.G. ...
	052.5318.--		3	34.G. ...
	052.5327.--		2	34.G. ...
	062.8426.ZC		1	34.G. ...
	052.5313.--		13	34.G. ...
	062.8440.--		1	34.G. ...
	052.5318.--		12	34.G. ...
	052.5327.--		6	34.G. ...
	062.7718.04		1	34.G. ...
	061.7130.PA		1	34.G. ...
	050.5083.--		3	34.G. ...
	061.7140.PA		1	34.G. ...
	061.7038.--		1	34.G. ...
	061.7098.--		1	34.G. ...
	050.5083.--		1	34.G. ...
	062.7834.--		4	34.G. ...
	052.5372.--		8	34.G. ...
	062.8038.07		6	34.G. ...
	052.5301.--		6	34.G. ...
	052.5304.--		6	34.G. ...
	062.8025.XX		2	34.G. ...
	053.5403.--		8	34.G. ...
	062.7715.XX		2	34.G. ...
	050.5051.--		2	34.G. ...
	052.5310.--		4xH (3/m)	34.G. ...
	052.5317.--		2xH (3/m)	34.G. ...
	069.8704.01		24	34.G. ...
	062.6857.04		1	34.G. ...
	069.6830.04		min. 2	34.G. ...
	080.9124.SY		(2xB)+(6xH)	34.G. ...
	080.9114.SY		(2xB)+(6xH)	34.G. ...
	080.9381.04		(8xB)+(12xH)	34.G. ...
	080.9424.04		4xH	34.G. ...
	080.9430.04		4xH	34.G. ...
	081.9241.07		(4xB)+(4xH)	34.G. ...

met dwarsstijl
avec traverse
with transom
mit Sprossenprofil

t1=T1-167
t2=T2-167

(*)

met dwarsstijl
avec traverse
with transom
mit Sprossenprofil
+

(*) Afhankelijk van de hoogte
Dépend de l'hauteur
Dependent of the height
Von der Höhe abhängig

068.8732.00		6	34.G. ...
050.5153.--		12	34.G. ...
069.8704.01		12	34.G. ...
080.9124.SY		2xB	34.G. ...
080.9114.SY		2xB	34.G. ...

VARIANT HI

080.9439.04		(1xB)+(4xH)	34.G. ...
080.9625.07		(2xB)+(6xH)	34.G. ...

VLEUGELGEWICHT POIDS DU VANTAIL WEIGHT OF THE VENT FLUEGELGEWICHT	MAX. 250KG
--	------------

A - A

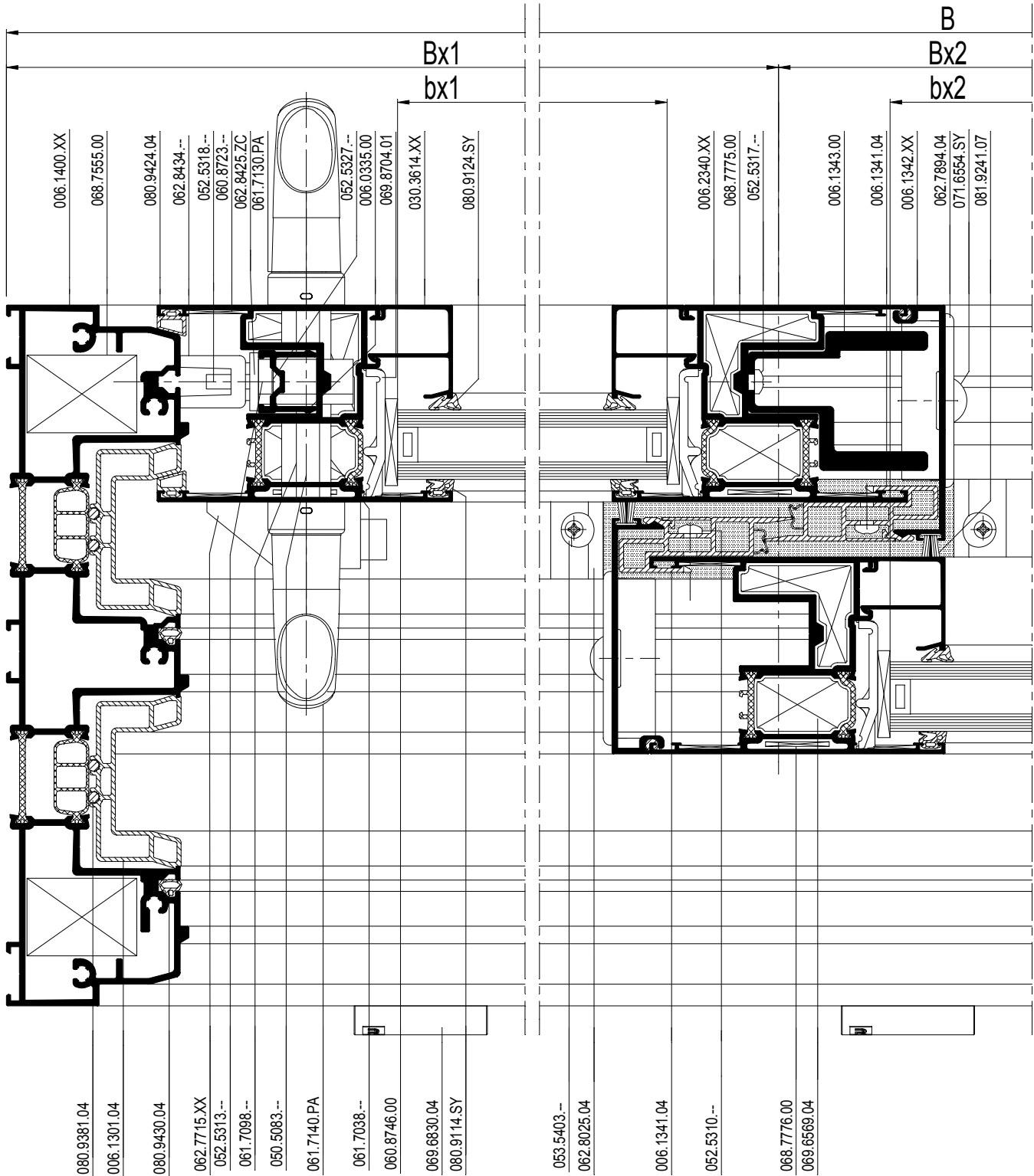

schaal - échelle
 scale - Maßstab
 1/2
 D0045159

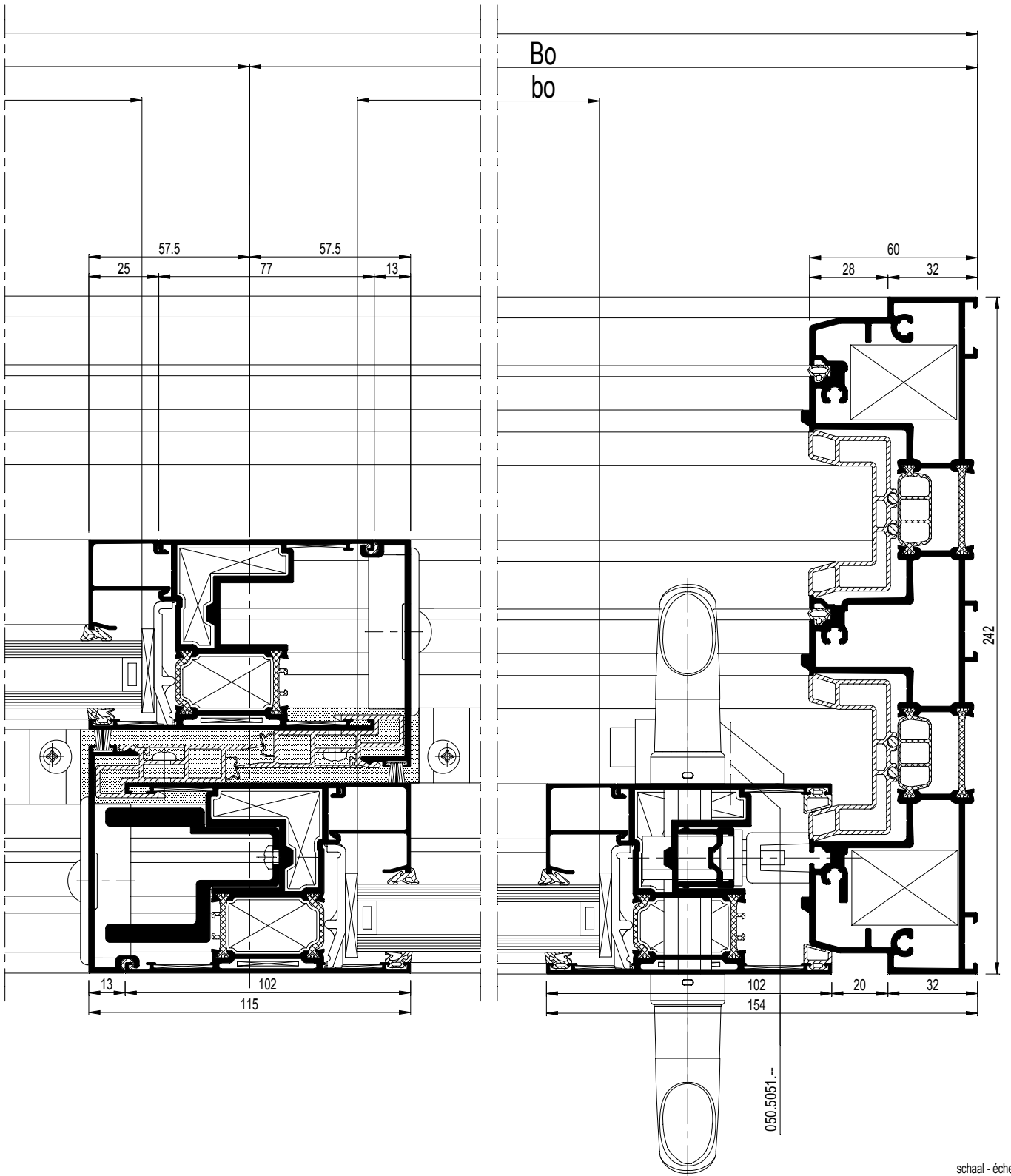

schaal - échelle
 scale - Maßstab
 1/2

D0045159

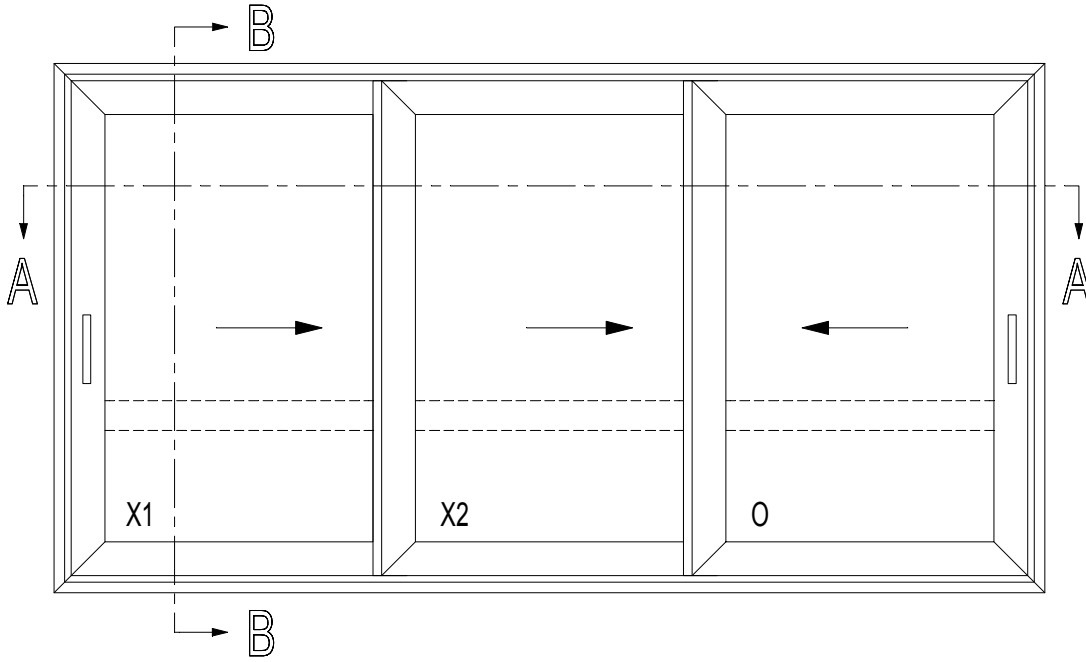

VLEUGELGEWICHT POIDS DU VANTAIL WEIGHT OF THE VENT FLUEGELGEWICHT	MAX. 250KG
--	------------

HOOGTE HAUTEUR HEIGHT HOEHE	MIN. 1895 MM
--------------------------------------	--------------

B - B

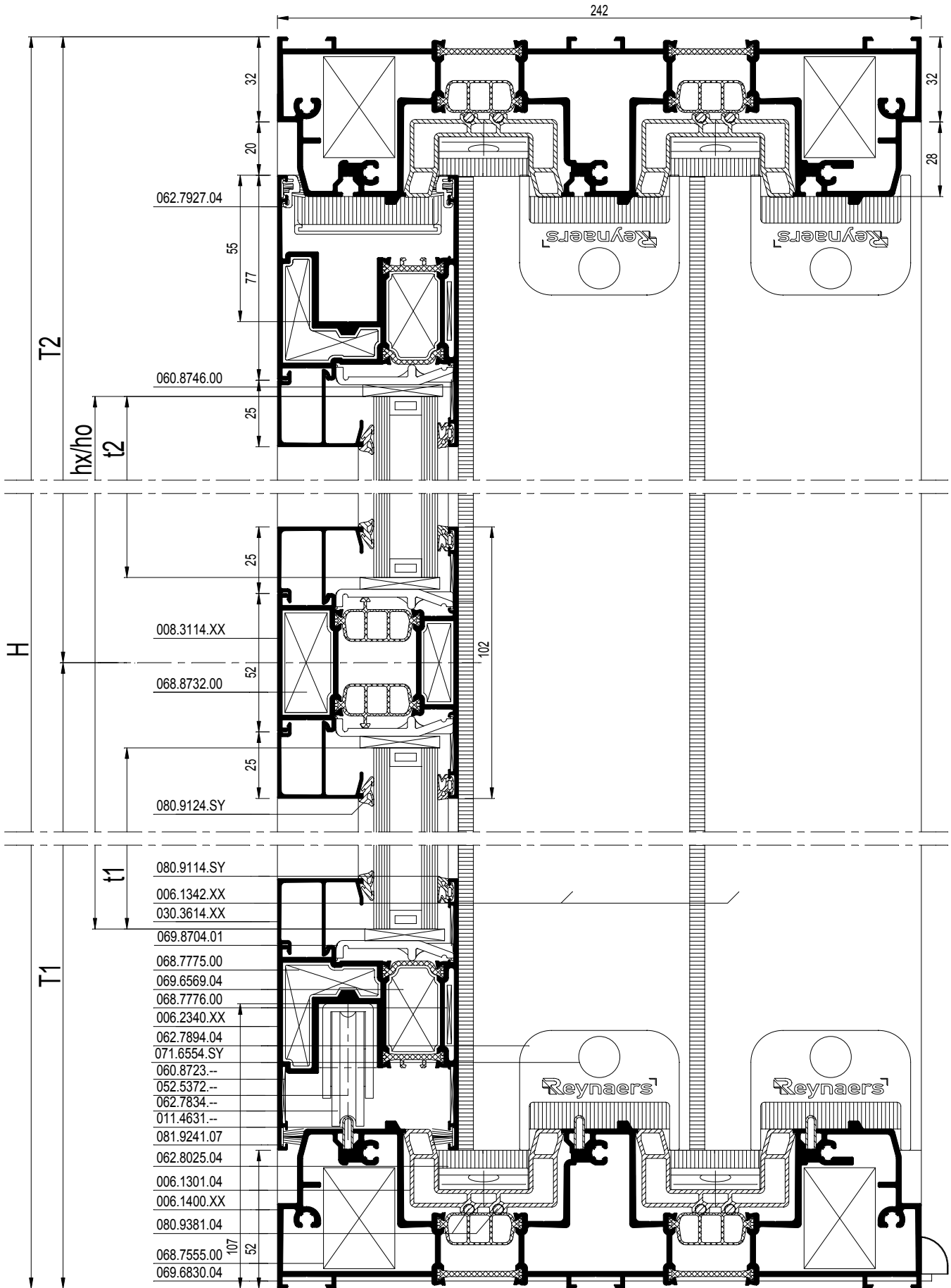

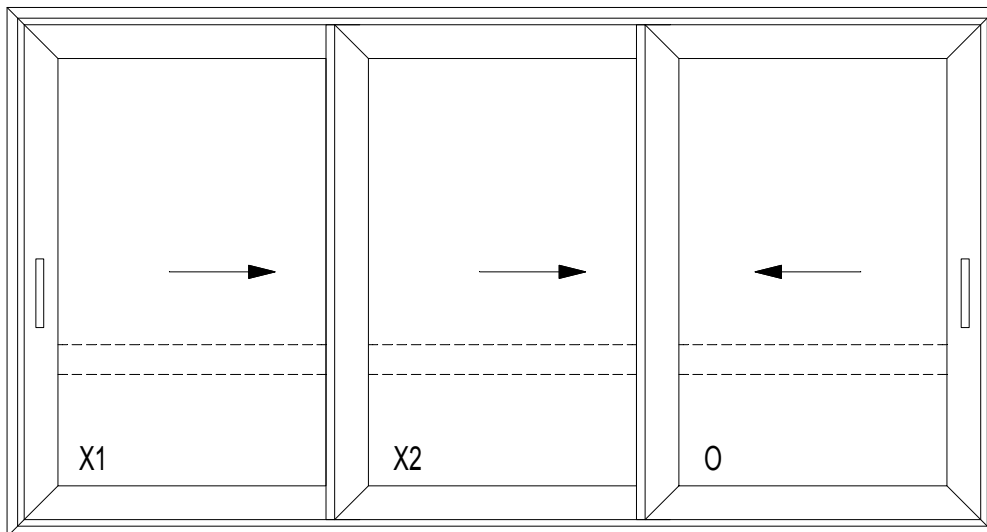

			#	$\leftarrow L_m \rightarrow$	
006.1400.XX			2	B	34.C. ...
			2	H	
006.1301.04			4	B	34.C. ...
			4	H	
011.4631.--			3	B-116	34.C. ...
006.2340.XX			2	Bx1-7.5	34.C. ...
			2	Bx2+89	
			2	Bo-7.5	
			6	H-104	
006.1342.XX			4	H-104	34.C. ...
006.1341.04			4	H-104	34.C. ...
006.1343.XX			2	H-162	34.C. ...
006.0335.00			1	280MM	34.C. ...
				(062.8425.ZC)	
			1	H-214	
				(062.8426.ZC)	
030.3614.XX			2	Bx1-161.5	34.C. ...
			2	Bx2-65	
			2	Bo-161.5	
			6	H-308	

met dwarsstijl
 avec traverse
 with transom
 mit Sprossenprofil
 +

008.3114.XX			1	Bx1-161.5	34.C. ...
			1	Bx2-65	
			1	Bo-161.5	

VLEUGELGEWICHT POIDS DU VANTAIL WEIGHT OF THE VENT FLUEGELGEWICHT	MAX. 250KG
--	------------

HOOGTE HAUTEUR HEIGHT HOEHE	MIN. 1895 MM
--------------------------------------	--------------

			#	
bx1=Bx1-173.5	068.7555.00		8	34.G. ...
bx2=Bx2-77	068.7775.00		12	34.G. ...
bo=Bo-173.5	069.6569.04		12	34.G. ...
hx/hq=H-270	068.7776.00		12	34.G. ...
	060.8723.--		24	34.G. ...
	060.8746.00		12	34.G. ...
	062.7894.04		4	34.G. ...
	052.5317.--		8	34.G. ...
	071.6554.SY		8	34.G. ...
	062.7927.04		min. 12	34.G. ...
	062.8425.ZC		2	34.G. ...
	052.5313.--		4	34.G. ...
	062.8434.--		2	34.G. ...
	052.5318.--		6	34.G. ...
	052.5327.--		4	34.G. ...
	062.8426.ZC		2	34.G. ...
	052.5313.--		26	34.G. ...
	062.8440.--		2	34.G. ...
	052.5318.--		24	34.G. ...
	052.5327.--		12	34.G. ...
	062.7718.04		2	34.G. ...
	061.7130.PA		2	34.G. ...
	050.5083.--		6	34.G. ...
	061.7140.PA		2	34.G. ...
	061.7038.--		2	34.G. ...
	061.7098.--		2	34.G. ...
	062.7834.--		6	34.G. ...
	052.5372.--		12	34.G. ...
	062.8025.04		2	34.G. ...
	053.5403.--		8	34.G. ...
	062.7715.XX		2	34.G. ...
	050.5051.--		2	34.G. ...
	052.5310.--		4xH (3/m)	34.G. ...
	052.5317.--		2xH (3/m)	34.G. ...
	069.8704.01		24	34.G. ...
	062.6857.04		1	34.G. ...
	069.6830.04		min. 2	34.G. ...
	080.9124.SY		(2xB)+(6xH)	34.G. ...
	080.9114.SY		(2xB)+(6xH)	34.G. ...
	080.9381.04		(8xB)+(12xH)	34.G. ...
	080.9424.04		4xH	34.G. ...
	080.9430.04		4xH	34.G. ...
	081.9241.07		(4xB)+(4xH)	34.G. ...

met dwarsstijl
avec traverse
with transom
mit Sprossenprofil

t1=T1-167
t2=T2-167

(*)

met dwarsstijl
avec traverse
with transom
mit Sprossenprofil
+

068.8732.00		6	34.G. ...
050.5153.--		12	
069.8704.01		12	34.G. ...
080.9124.SY		2xB	34.G. ...
080.9114.SY		2xB	34.G. ...

VARIANT HI

080.9439.04		(1xB)+(4xH)	34.G. ...
080.9625.07		(2xB)+(6xH)	34.G. ...

(*) Afhankelijk van de hoogte
Dépend de l'hauteur
Dependent of the height
Von der Höhe abhängig

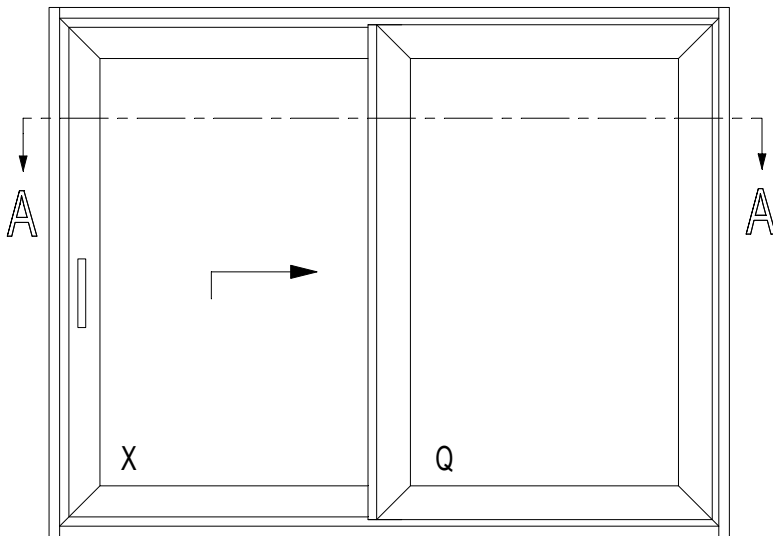

A - A

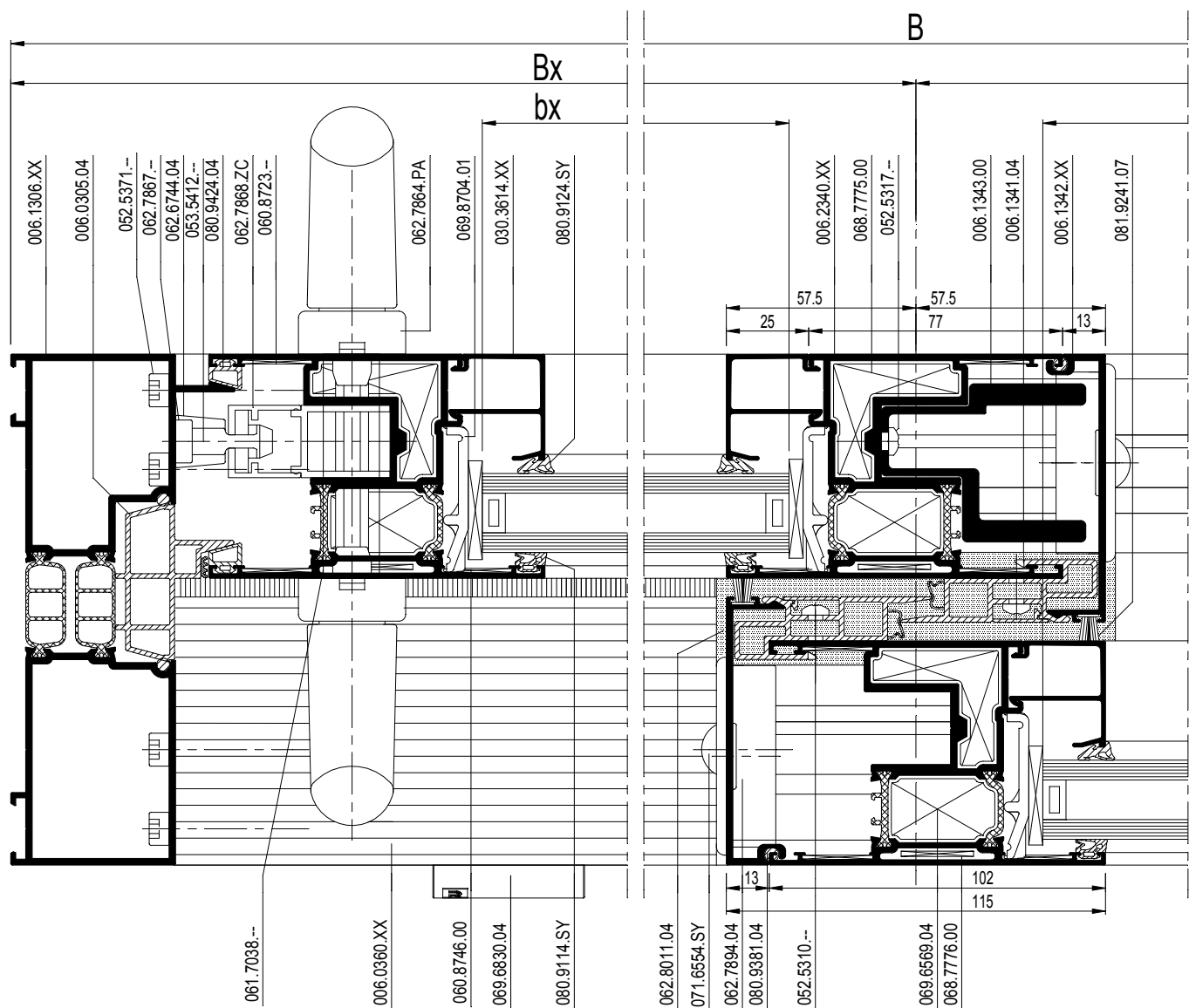

D0013930

(A)	VLEUGELGEWICHT POIDS DU VANTAIL WEIGHT OF THE VENT FLUEGELGEWICHT	MAX. 300KG
(B)	VLEUGELGEWICHT POIDS DU VANTAIL WEIGHT OF THE VENT FLUEGELGEWICHT	MIN. 300KG MAX. 400KG
	HOOGTE HAUTEUR HEIGHT HOEHE	MIN. 1780 MM

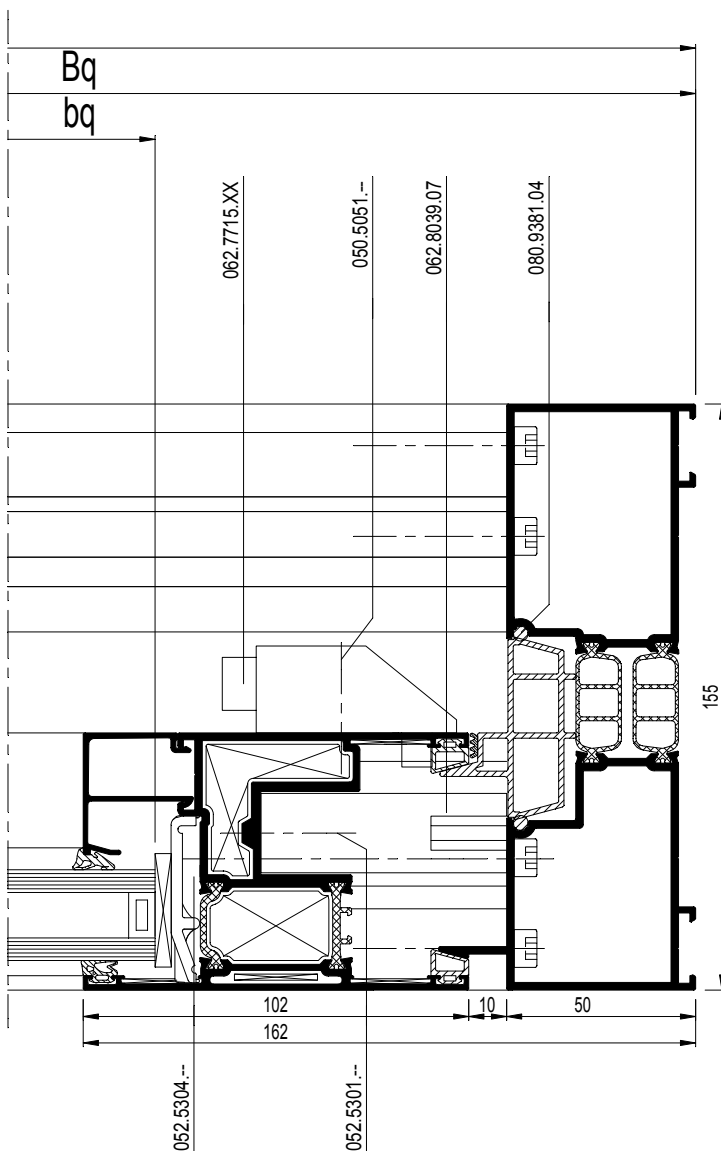

CP 155-LS

2-RAIL XQ
2-RAIL XQ
2-RAIL XQ
2-RAIL XQ

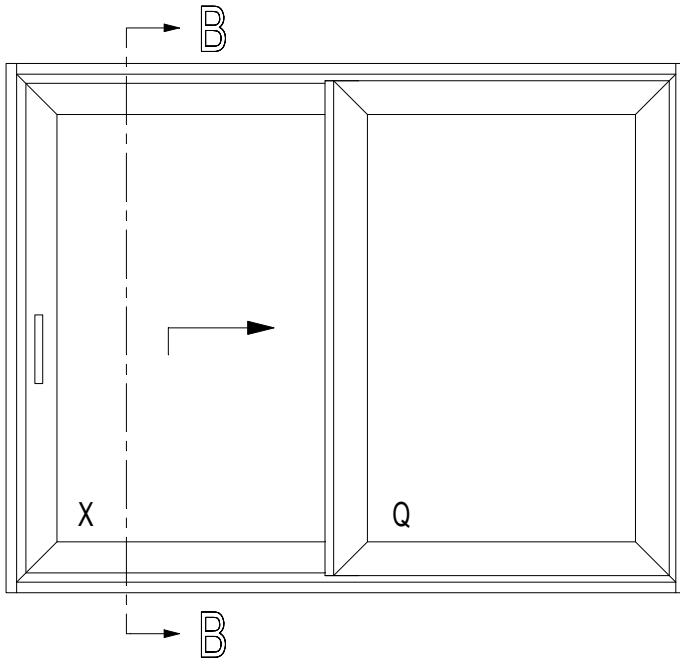

(A)	VLEUGELGEWICHT POIDS DU VANTAIL WEIGHT OF THE VENT FLUEGELGEWICHT	MAX. 300KG
(B)	VLEUGELGEWICHT POIDS DU VANTAIL WEIGHT OF THE VENT FLUEGELGEWICHT	MIN. 300KG MAX. 400KG
	HOOGTE HAUTEUR HEIGHT HOEHE	MIN. 1780 MM

schaal - échelle
scale - Maßstab
1/2

D0013931

B - B

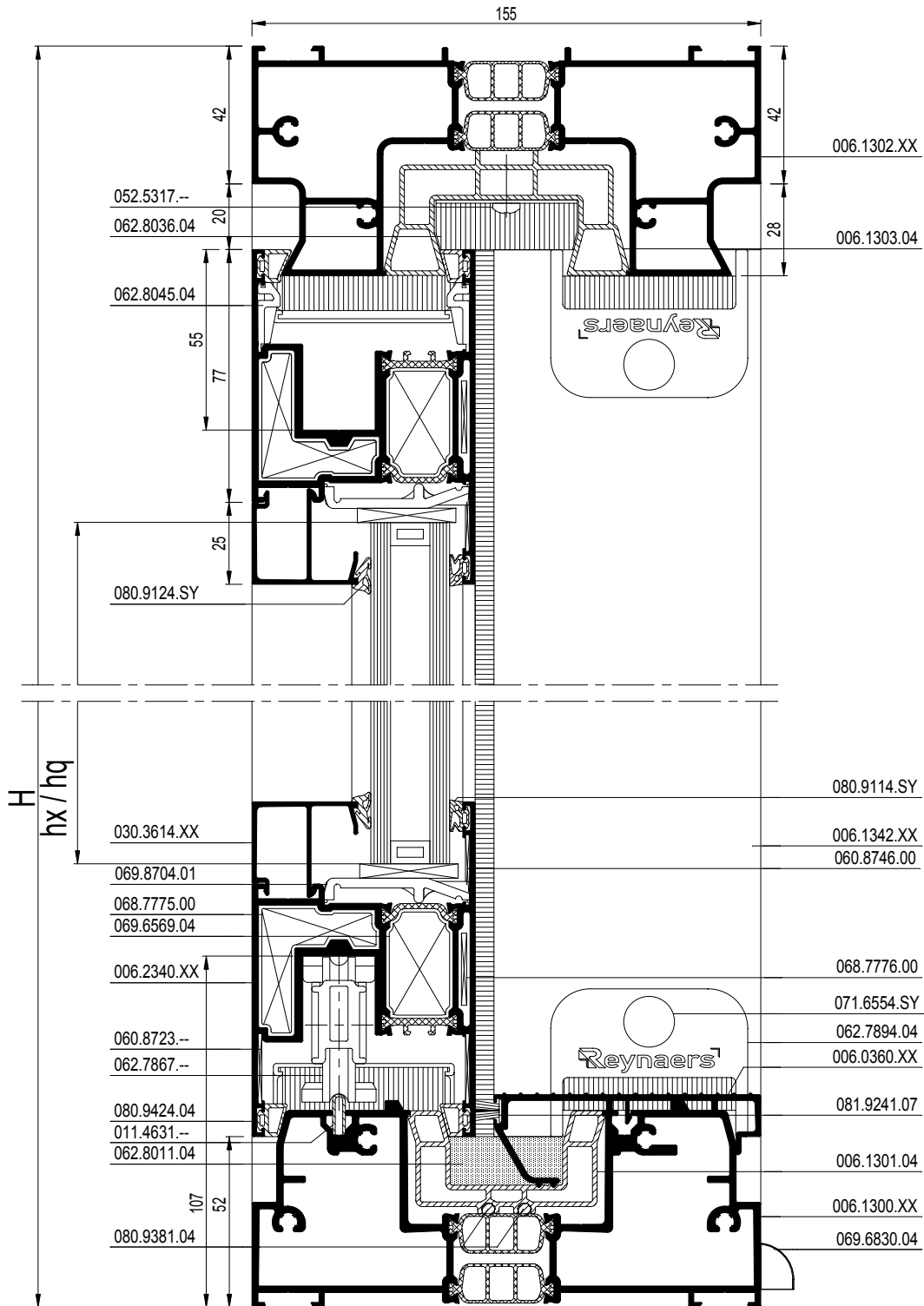

schaal - échelle
 scale - Maßstab
 1/2

D0013931

CP 155-LS

2-RAIL XQ
2-RAIL XQ
2-RAIL XQ
2-RAIL XQ

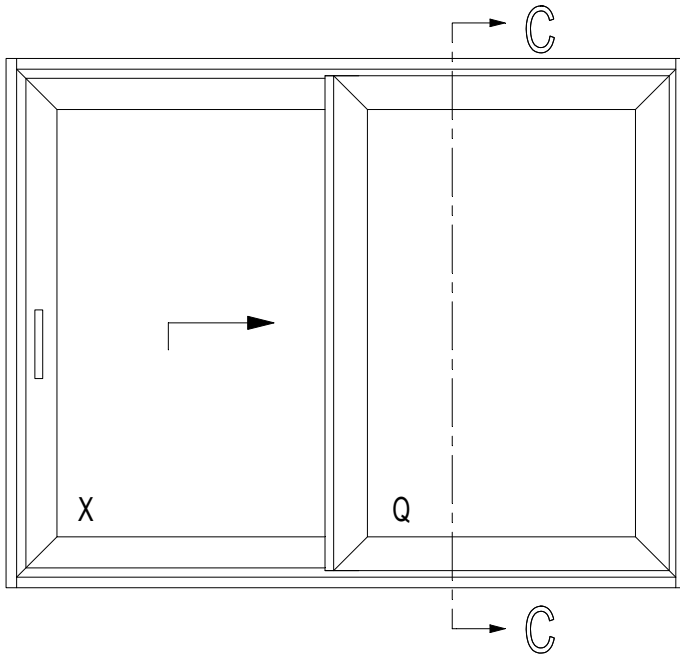

(A)	VLEUGELGEWICHT POIDS DU VANTAIL WEIGHT OF THE VENT FLUEGELGEWICHT	MAX. 300KG
(B)	VLEUGELGEWICHT POIDS DU VANTAIL WEIGHT OF THE VENT FLUEGELGEWICHT	MIN. 300KG MAX. 400KG
	HOOGTE HAUTEUR HEIGHT HOEHE	MIN. 1780 MM

schaal - échelle
scale - Maßstab
1/2
D00090798

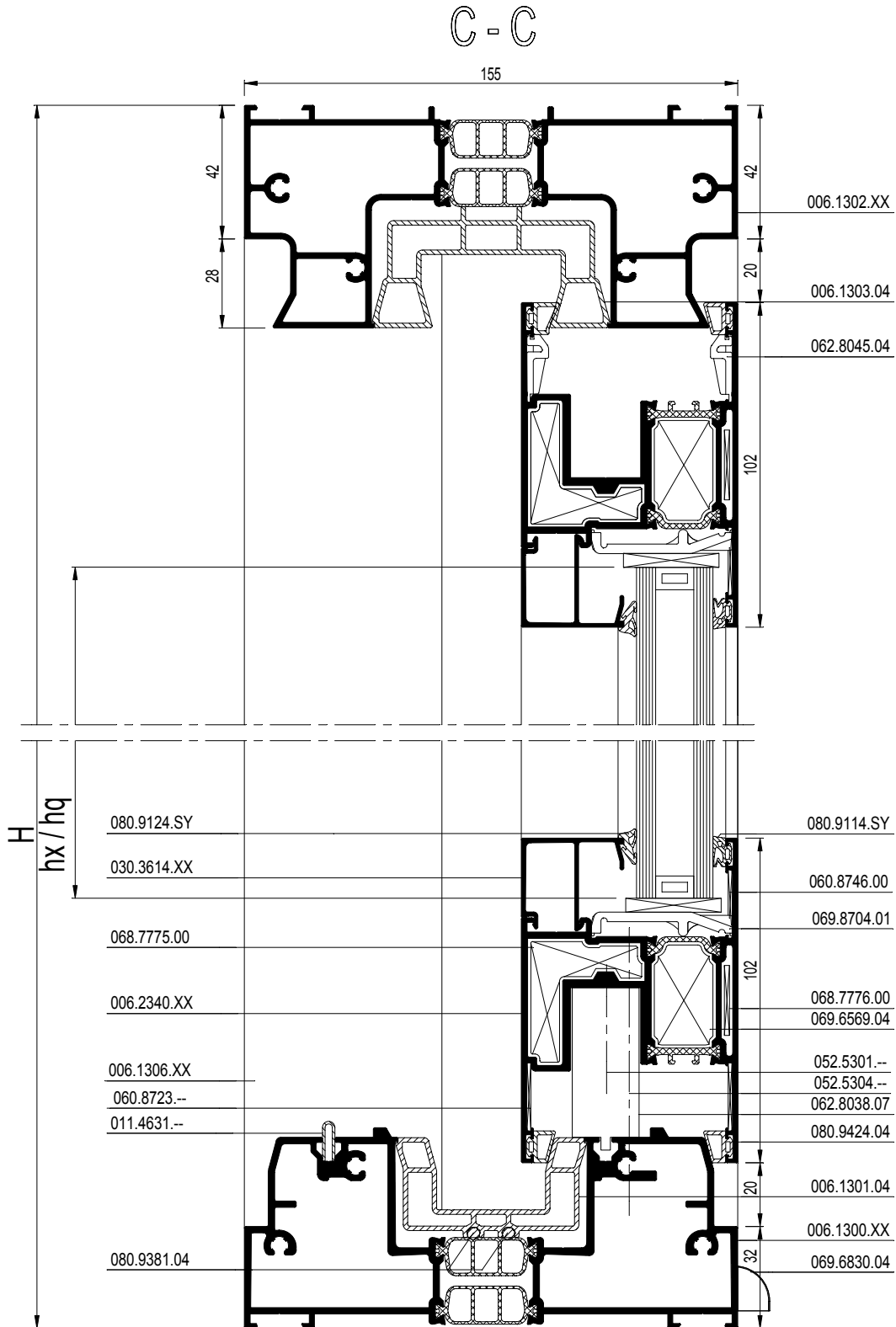

schaal - échelle
 scale - Maßstab
 1/2

D0090798

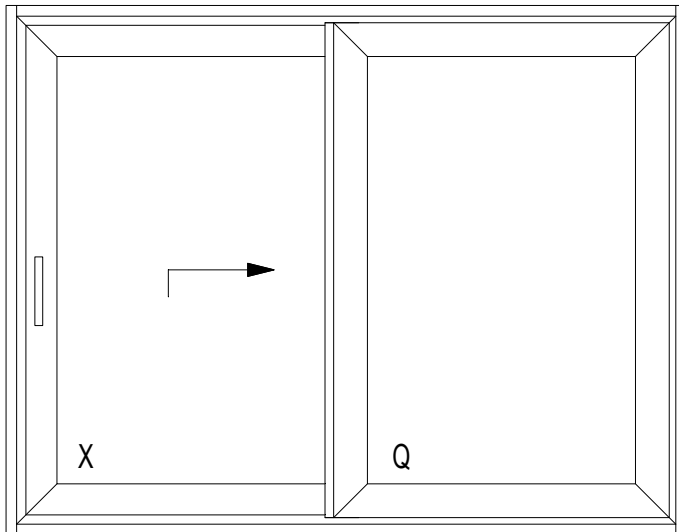

HOOGTE HAUTEUR HEIGHT HOEHE	MIN. 1780 MM
--------------------------------------	--------------

(A) VLEUGELGEWICHT POIDS DU VANTAIL WEIGHT OF THE VENT FLUEGELGEWICHT	MAX. 300KG
--	------------

(B) VLEUGELGEWICHT POIDS DU VANTAIL WEIGHT OF THE VENT FLUEGELGEWICHT	MIN. 300KG MAX. 400KG
--	--------------------------

			#	L_m	
006.1300.XX 006.1301.04			1	B-100	34.C. ...
006.1302.XX 006.1303.04			1	B-100	34.C. ...
006.1306.XX			2	H	34.C. ...
006.0305.04			2	H-150	34.C. ...
011.4631.--			1	B-100	34.C. ...
006.2340.XX			2	Bx-15.5	34.C. ...
			2	Bq-15.5	
			4	H-114	
006.1342.XX			2	H-114	34.C. ...
006.1341.04			2	H-114	34.C. ...
006.1343.00			1	H-172	34.C. ...
030.3614.XX			2	Bx-169.5	34.C. ...
			2	Bq-169.5	
			4	H-318	
006.0360.XX			1	Bx-110.5	34.C. ...
(A) 0M0.1505.XX			1	Bx-678.5	34.C. ...
(B) 0M0.1505.XX			2	40	34.C. ...
			1	Bx-1302.5	34.C. ...

bx = Bx-181.5
hx = H-280
bq = Bq-181.5
hq = H-280

			#	
	052.5371.--		16	34.G.
	068.7775.00		8	34.G.
	069.6569.04		8	34.G.
	068.7776.00		8	34.G.
	060.8723.--		16	34.G.
	060.8746.00		8	34.G.
	062.7894.04		2	34.G.
	052.5317.--		4	34.G.
	071.6554.SY		4	34.G.
	062.8045.04		2	34.G.
(*)	062.7902.ZC <small>OF-OU-OR-ODER</small>		1	34.G.
	062.7868.ZC		1	34.G.
	062.6744.04		2	34.G.
	053.5412.--		2	34.G.
	062.7864.PA		1	34.G.
	061.7038.--		1	34.G.
(A)	062.7715.XX		1	34.G.
	050.5051.--		1	34.G.
(B)	062.7715.XX		2	34.G.
	050.5051.--		2	34.G.
	057.5721.--		2	34.G.
(A)	062.7867.--		1	34.G.
(B)	062.7867.--		1	34.G.
	062.7903.--		1	34.G.
	062.8038.07		3	34.G.
	052.5301.--		3	34.G.
	052.5304.--		3	34.G.
	062.8039.07		3	34.G.
	052.5301.--		3	34.G.
	052.5304.--		3	34.G.

			#	
	062.8011.04		1	34.G.
	062.8036.04		1	34.G.
	052.5317.--		2	34.G.
(**)	062.9372.04 <small>OF-OU-OR-ODER</small>		2	34.G.
	062.9375.04		2	34.G.
	062.9396.04		2	34.G.
	052.5310.--		2xH (3/m)	34.G.
	052.5317.--		H (3/m)	34.G.
(A)	069.8704.01		16 (-250KG)	34.G.
(A)	069.8704.01		12 (+250KG)	34.G.
	069.8724.04		4	34.G.
(B)	069.8704.01		12	34.G.
	069.8724.04		8	34.G.
	069.6830.04		min. 2	34.G.
	062.6857.04		1	34.G.
	080.9124.SY		(2xB)+(4xH)	34.G.
	080.9114.SY		(2xB)+(4xH)	34.G.
	080.9381.04		(2xB)+(6xH)	34.G.
	080.9424.04		(4xB)+(4xH)	34.G.
	081.9241.07		(2xH)+(Bx)	34.G.

VARIANT HI

080.9439.04		(1xB)+(3xH)	34.G.
080.9625.07		(2xB)+(4xH)	34.G.

(*) Afhankelijk van de hoogte
Dépend de l'hauteur
Dependent of the height
Von der Höhe abhängig

(**) Afhankelijk van de positie van de primaire vleugel
Dépend de la position de ouvrante principale
depending on the position of the primary vent
abhängig von der Position des primären Fluegel

(A)	VLEUGELGEWICHT POIDS DU VANTAIL WEIGHT OF THE VENT FLUEGELGEWICHT	MAX. 300KG
(B)	VLEUGELGEWICHT POIDS DU VANTAIL WEIGHT OF THE VENT FLUEGELGEWICHT	MIN. 300KG MAX. 400KG
	HOOGTE HAUTEUR HEIGHT HOEHE	MIN. 1780 MM

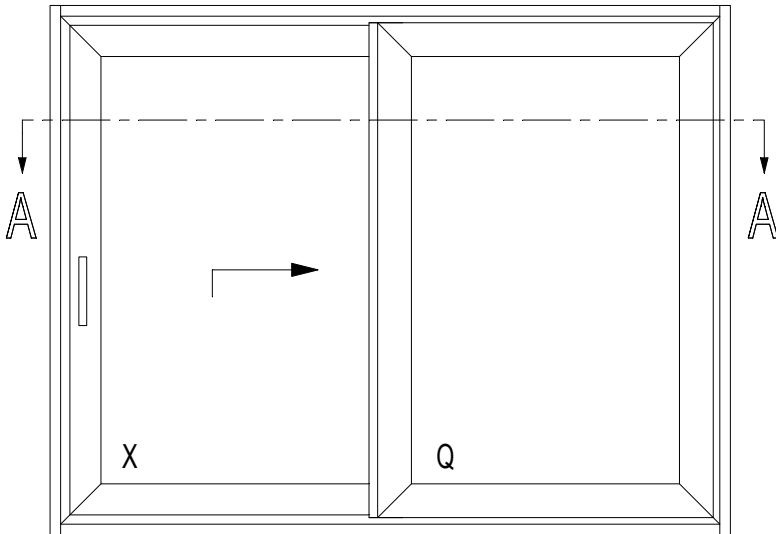

A - A

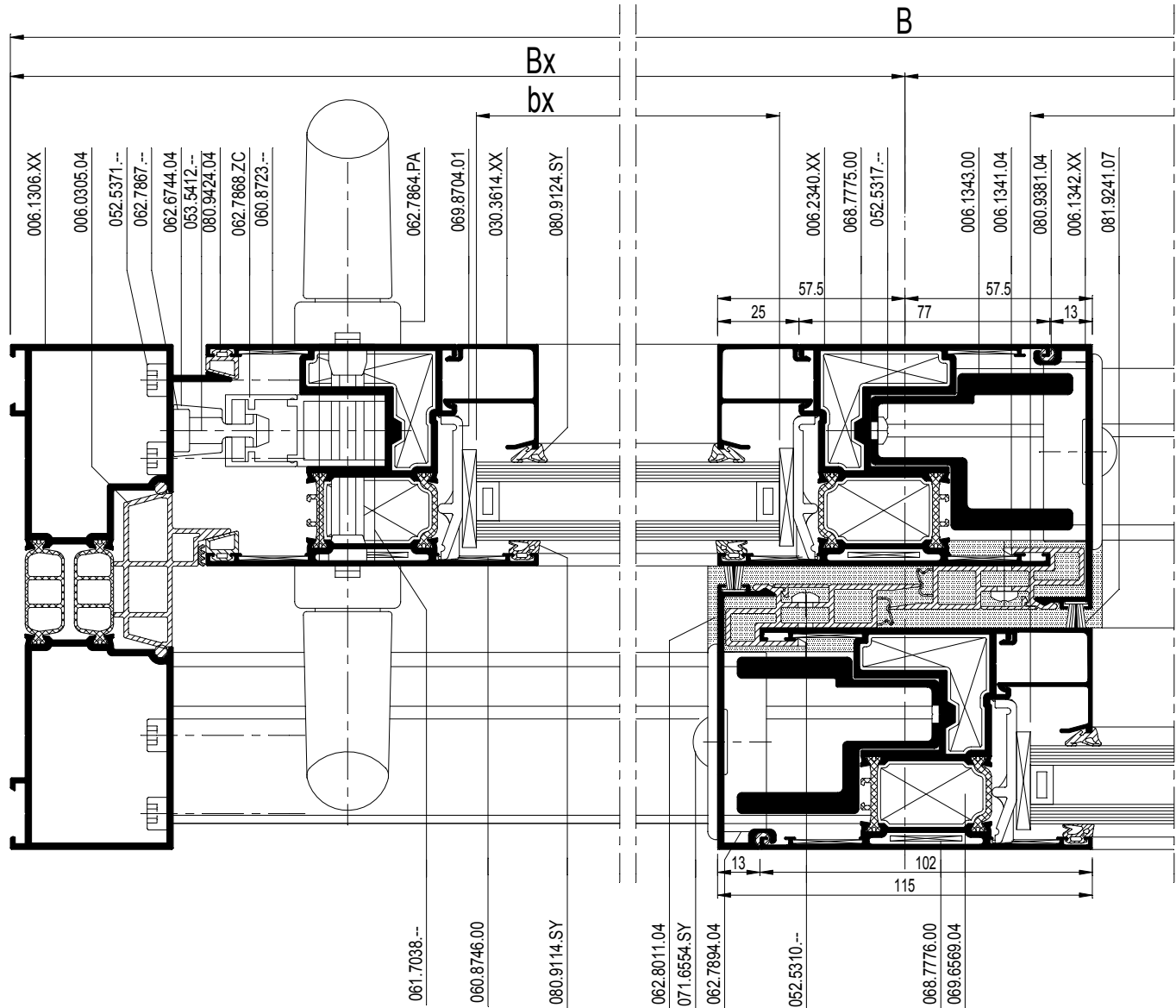

D0074742

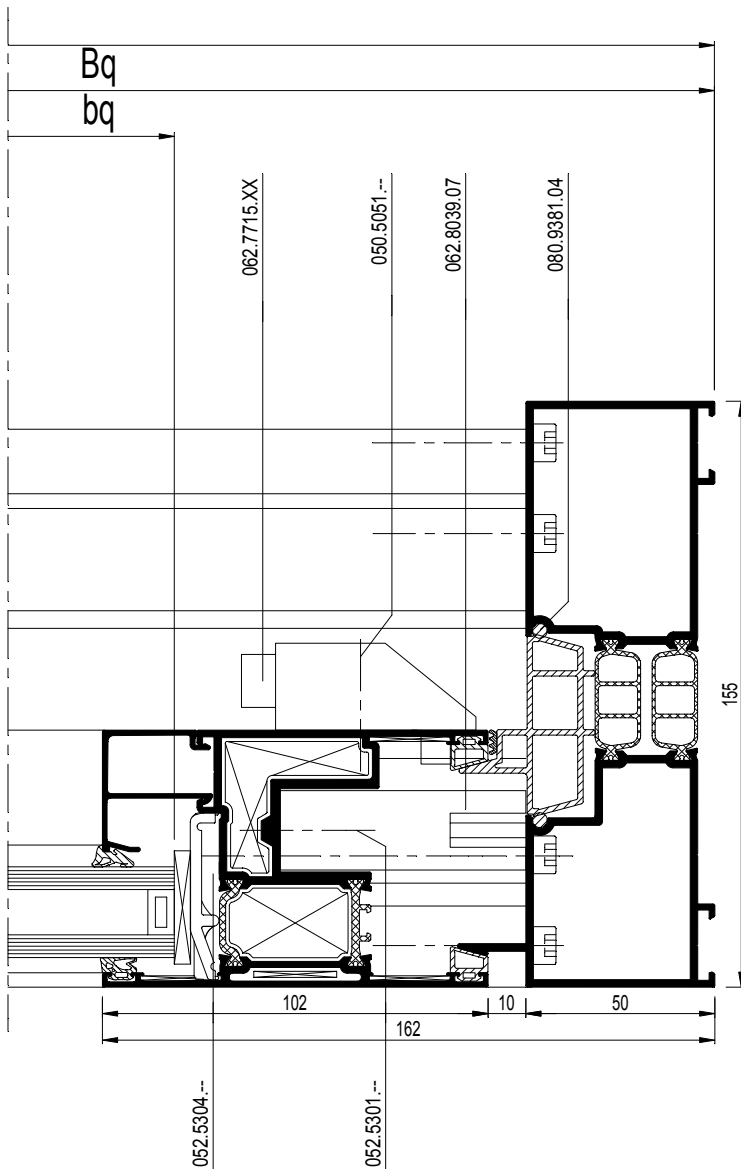

CP 155-LS

2-RAIL XQ FLAT BOTTOM
2-RAIL XQ FLAT BOTTOM
2-RAIL XQ FLAT BOTTOM
2-RAIL XQ FLAT BOTTOM

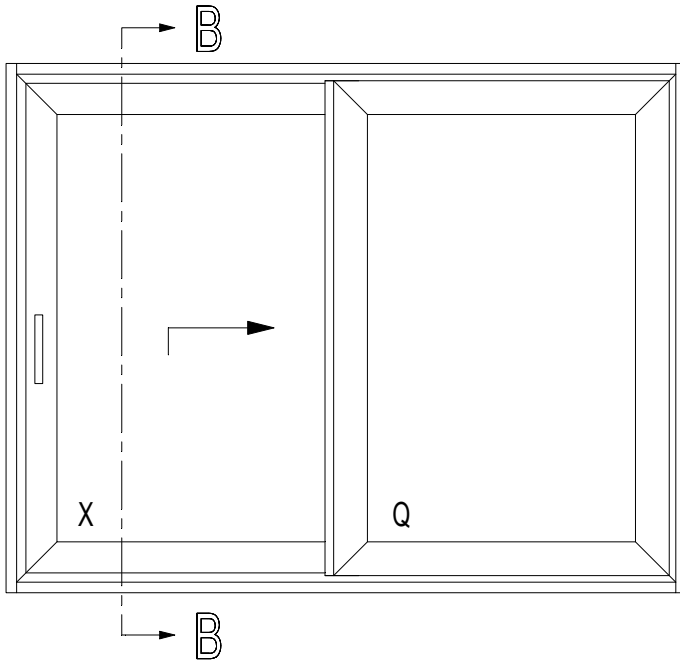

HOOGTE HAUTEUR HEIGHT HOEHE	MIN. 1780 MM
--------------------------------------	--------------

(A) VLEUGELGEWICHT POIDS DU VANTAIL WEIGHT OF THE VENT FLUEGELGEWICHT	MAX. 300KG
--	------------

(B) VLEUGELGEWICHT POIDS DU VANTAIL WEIGHT OF THE VENT FLUEGELGEWICHT	MIN. 300KG MAX. 400KG
--	--------------------------

B - B

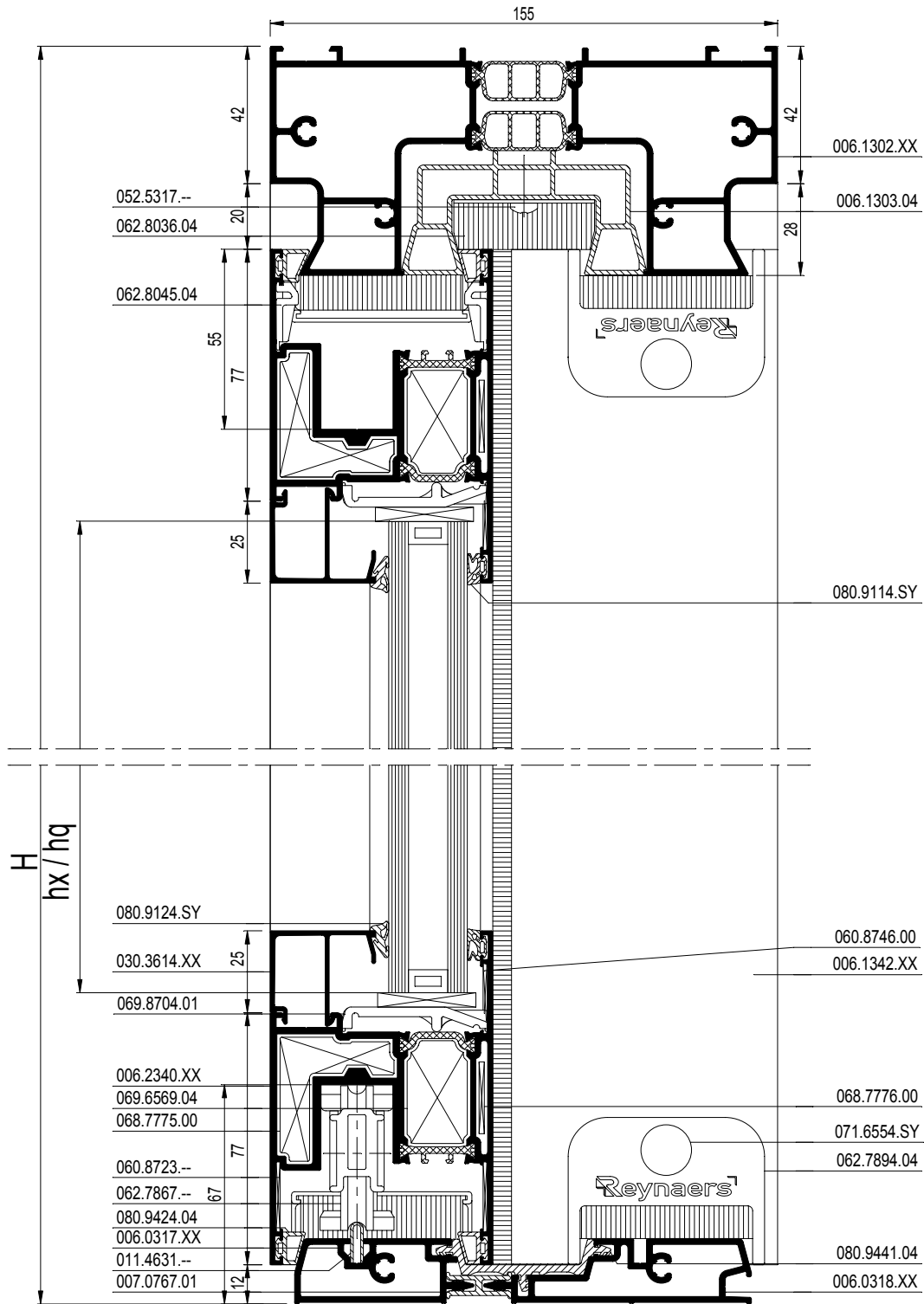



bx = Bx-181.5
hx = H-240
bq = Bq-181.5
hq = H-240

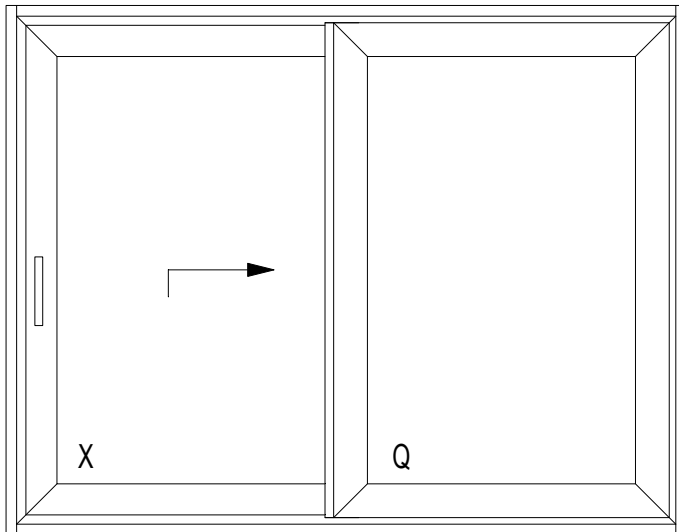

























































				#	$\leftarrow L_m \rightarrow$	
	006.0317.XX			1	B-100	34.C. ...
	006.0318.XX			1	B-100	34.C. ...
	007.0767.01			1	B-100	34.C. ...
	006.1302.XX 006.1303.04			1	B-100	34.C. ...
	006.1306.XX			2	H	34.C. ...
	006.0305.04			2	H-75	34.C. ...
	011.4631.--			1	B-100	34.C. ...
	006.2340.XX			2	Bx-15.5	34.C. ...
				2	Bq-15.5	
				4	H-74	
	006.1342.XX			2	H-74	34.C. ...
	006.1341.04			2	H-74	34.C. ...
	006.1343.00			2	H-132	34.C. ...
	030.3614.XX			2	Bx-169.5	34.C. ...
				2	Bq-169.5	
				4	H-278	
(A)	0M0.1505.XX			1	Bx-678.5	34.C. ...
(B)	0M0.1505.XX			2	40	34.C. ...
				1	Bx-1302.5	34.C. ...











































HOOGTE HAUTEUR HEIGHT HOEHE	MIN. 1780 MM
--------------------------------------	--------------

(A) VLEUGELGEWICHT POIDS DU VANTAIL WEIGHT OF THE VENT FLUEGELGEWICHT	MAX. 300KG
--	------------





(B) VLEUGELGEWICHT POIDS DU VANTAIL WEIGHT OF THE VENT FLUEGELGEWICHT	MIN. 300KG MAX. 400KG
--	--------------------------

schaal - échelle
 scale - Maßstab
 1/2
 D0084630

			#	
			12	34.G. ...
			8	34.G. ...
			8	34.G. ...
			8	34.G. ...
			16	34.G. ...
			8	34.G. ...
			2	34.G. ...
			4	34.G. ...
			4	34.G. ...
			2	34.G. ...
			1	34.G. ...
			1	34.G. ...
			2	34.G. ...
			2	34.G. ...
(A)			1	34.G. ...
			1	34.G. ...
(B)			2	34.G.
			2	34.G.
			2	34.G.
(A)			1	34.G. ...
(B)			1	34.G. ...
			1	34.G. ...
			3	34.G.
			3	34.G.
			3	34.G.
			3	34.G.
			3	34.G.

			#	
			1	34.G. ...
			1	34.G. ...
			2	34.G. ...
(**)			2	34.G. ...
			2	34.G. ...
			1	34.G. ...
			2	34.G. ...
			2xH (3/m)	34.G. ...
			H (3/m)	34.G. ...
(A)			16 (-250KG)	34.G. ...
(A)			12 (+250KG)	34.G. ...
			4	34.G. ...
(B)			12	34.G. ...
			8	34.G. ...
			(2xB)+(4xH)	34.G. ...
			(2xB)+(4xH)	34.G. ...
			6xH	34.G. ...
			(4xB)+(4xH)	34.G. ...
			(2xH)	34.G. ...
			B-100	34.G. ...

VARIANT HI

		(1xB)+(3xH)	34.G. ...
		(2xB)+(4xH)	34.G. ...

(*) Afhankelijk van de hoogte
 Dépend de l'hauteur
 Dependent of the height
 Von der Höhe abhängig

(**) Afhankelijk van de positie van de primaire vleugel
 Dépend de la position de ouvrante principale
 depending on the position of the primary vent
 abhängig von der Position des primären Fluegel

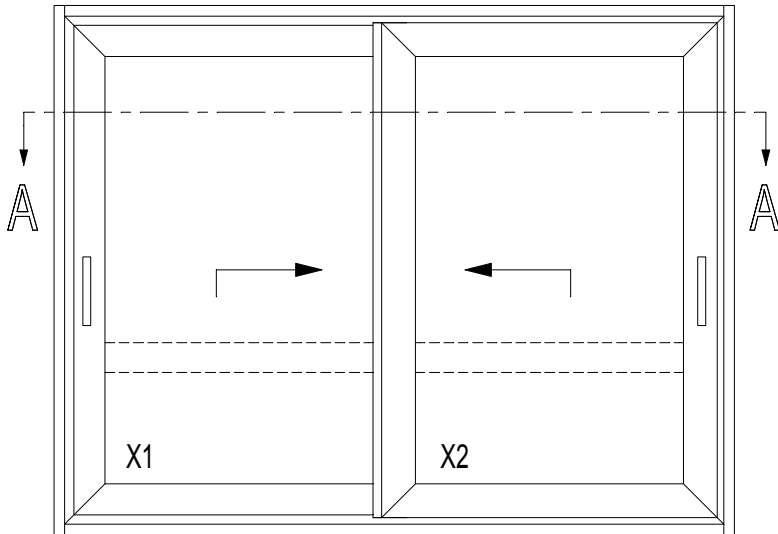

A - A

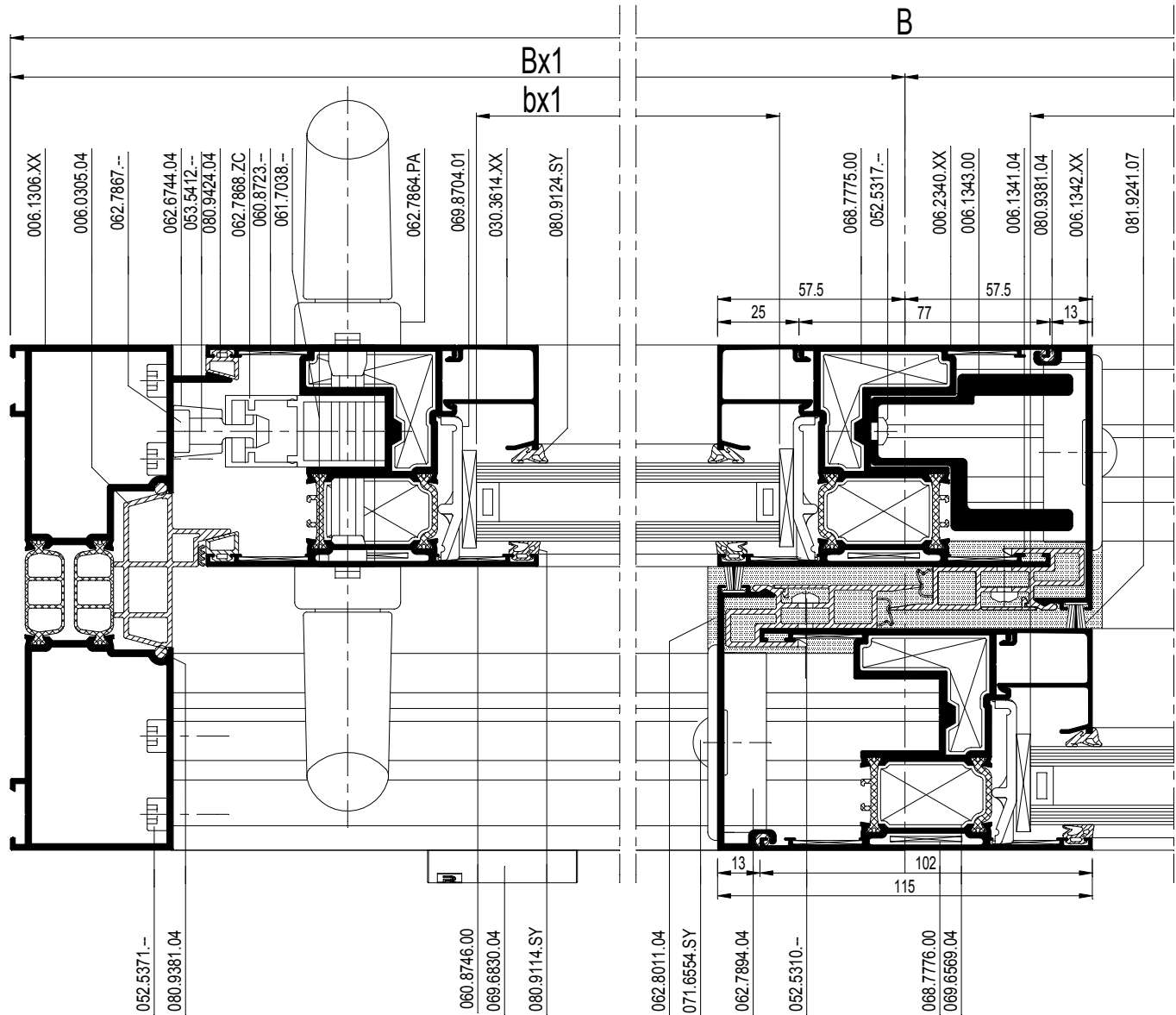

schaal - échelle
 scale - Maßstab
 1/2
 D001393Z

(A)	VLEUGELGEWICHT POIDS DU VANTAIL WEIGHT OF THE VENT FLUEGELGEWICHT	MAX. 300KG
(B)	VLEUGELGEWICHT POIDS DU VANTAIL WEIGHT OF THE VENT FLUEGELGEWICHT	MIN. 300KG MAX. 400KG
	HOOGTE HAUTEUR HEIGHT HOEHE	MIN. 1780 MM

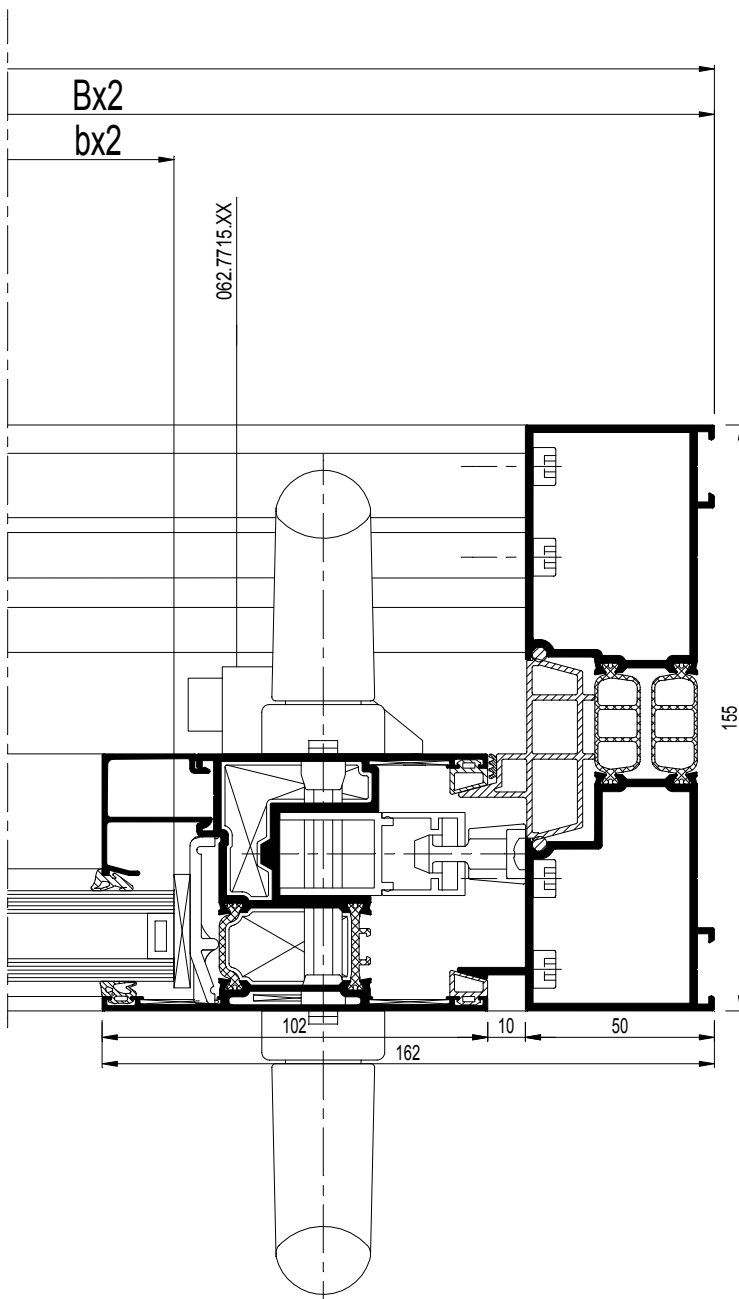

schaal - échelle
 scale - Maßstab
 1/2

D0013932

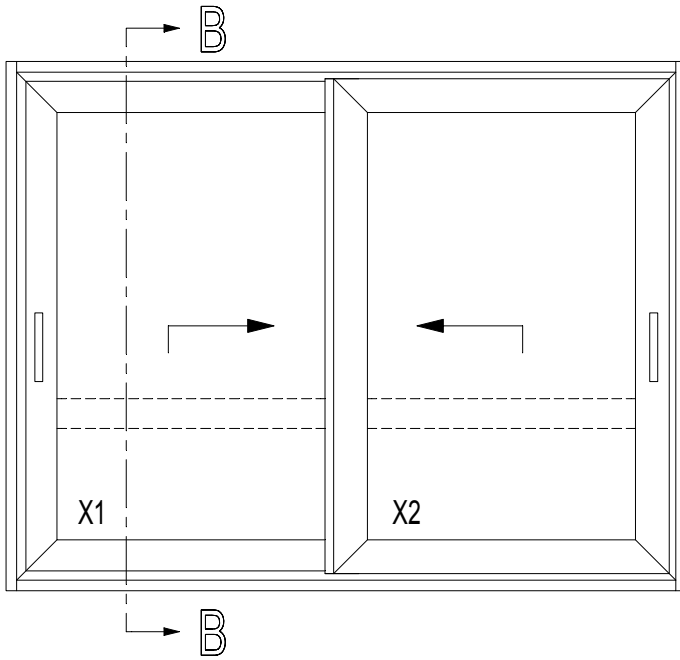

(A)	VLEUGELGEWICHT POIDS DU VANTAIL WEIGHT OF THE VENT FLUEGELGEWICHT	MAX. 300KG
(B)	VLEUGELGEWICHT POIDS DU VANTAIL WEIGHT OF THE VENT FLUEGELGEWICHT	MIN. 300KG MAX. 400KG
	HOOGTE HAUTEUR HEIGHT HOEHE	MIN. 1780 MM

D0013933

B - B

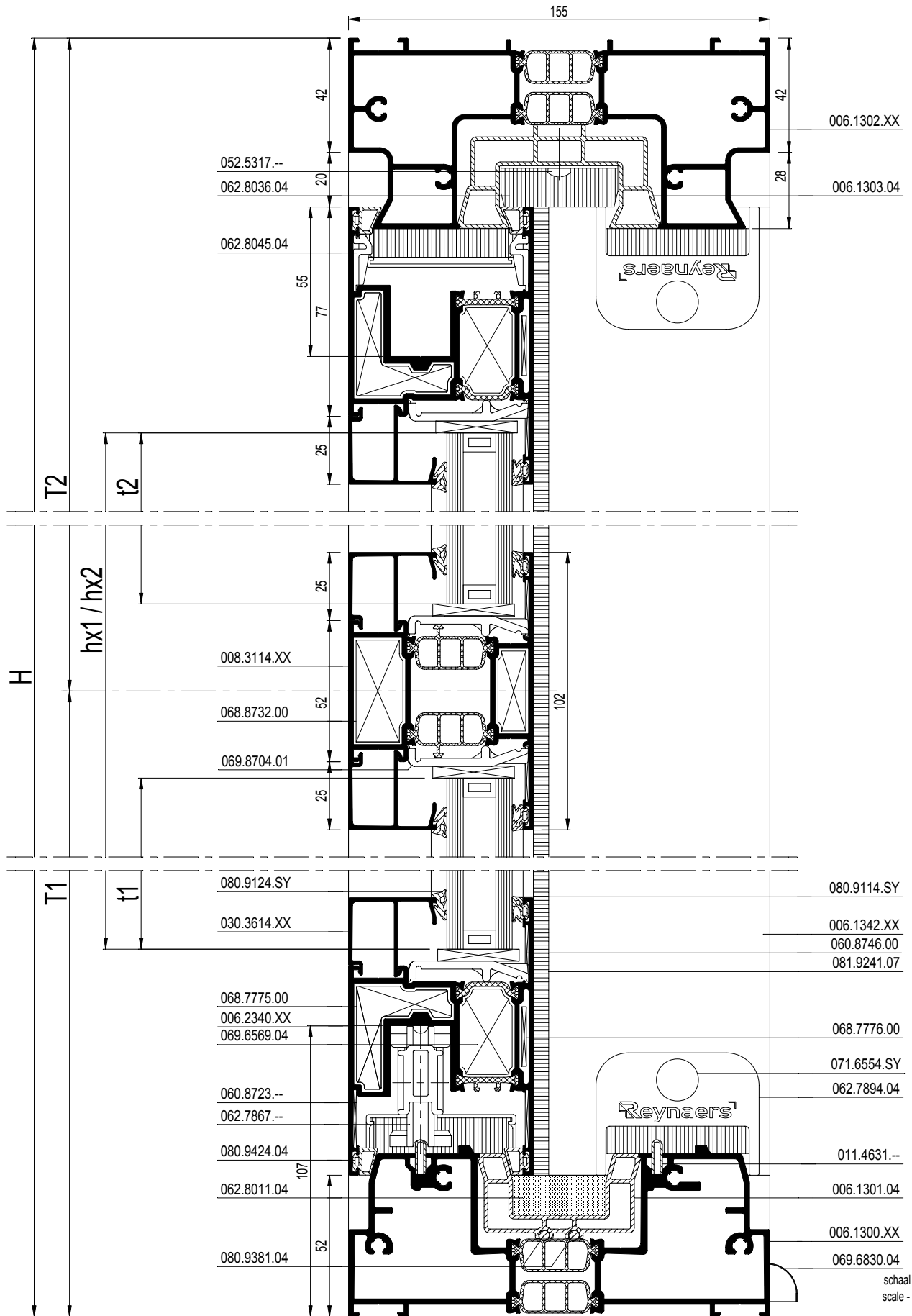

schaal - échelle
 scale - Maßstab
 1/2

D0013933

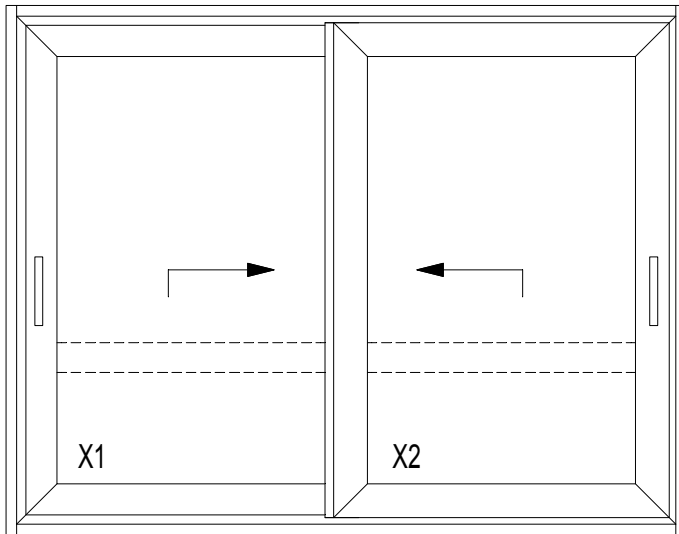

bx1 = Bx1-181.5

hx1 = H-280

bx2 = Bx2-181.5

hx2 = H-280

met dwarsstijl
avec traverse
with transom
mit Sprossenprofil

t1 = T1-167

t2 = T2-177

			#	L_m	
006.1300.XX 006.1301.04			1	B-100	34.C. ...
006.1302.XX 006.1303.04			1	B-100	34.C. ...
006.1306.XX			2	H	34.C. ...
006.0305.04			2	H - 150	34.C. ...
011.4631.-			2	B-100	34.C. ...
006.2340.XX			2	Bx1-15.5	34.C. ...
			2	Bx2-15.5	
			4	H-114	
006.1342.XX			2	H-114	34.C. ...
006.1341.04			2	H-114	34.C. ...
006.1343.00			1	H-172	34.C. ...
030.3614.XX			2	Bx1-169.5	34.C. ...
			2	Bx2-169.5	
			4	H-318	
(A) 0M0.1505.XX			1	Bx1-678.5	34.C. ...
			1	Bx2-678.5	
(B) 0M0.1505.XX			4	40	34.C. ...
			1	Bx1-1302.5	
			1	Bx2-1302.5	

met dwarsstijl
avec traverse
with transom
mit Sprossenprofil
+

008.3114.XX			1	Bx1-169.5	34.C. ...
			1	Bx2-169.5	

HOOGTE HAUTEUR HEIGHT HOEHE	MIN. 1780 MM
--------------------------------------	--------------

(A) VLEUGELGEWICHT POIDS DU VANTAIL WEIGHT OF THE VENT FLUEGELGEWICHT	MAX. 300KG
--	------------

(B) VLEUGELGEWICHT POIDS DU VANTAIL WEIGHT OF THE VENT FLUEGELGEWICHT	MIN. 300KG MAX. 400KG
--	--------------------------

			#	
			16	34.G ...
			8	34.G ...
			8	34.G ...
			8	34.G ...
			16	34.G ...
			8	34.G ...
			2	34.G ...
			4	34.G ...
			4	34.G ...
(*)			4	34.G ...
			2	34.G ...
			2	34.G ...
			4	34.G ...
			4	34.G ...
			2	34.G ...
			2	34.G ...
(A)			1	34.G ...
			1	34.G ...
(B)			2	34.G ...
			2	34.G ...
			2	34.G ...
(A)			2	34.G ...
(B)			2	34.G ...
			2	34.G ...

			#	
			1	34.G ...
			1	34.G ...
			2	34.G ...
(**)			2	34.G ...
			2	34.G ...
			2	34.G ...
			2xH (3/m)	34.G ...
			H (3/m)	34.G ...
(A)			16 (-250KG)	34.G ...
(A)			12 (+250KG)	34.G ...
			4	34.G ...
(B)			12	34.G ...
			8	34.G ...
			1	34.G ...
			min. 2	34.G ...
			(2xB)+(4xH)	34.G ...
			(2xB)+(4xH)	34.G ...
			(2xB)+(6xH)	34.G ...
			(4xB)+(4xH)	34.G ...
			2xH	34.G ...

met dwarsstijl
avec traverse
with transom
mit Sprossenprofil
+

			4	34.G ...
			8	34.G ...
			8	34.G ...
			2xB	34.G ...
			2xB	34.G ...

VARIANT HI

			(1xB)+(3xH)	34.G ...
			(2xB)+(4xH)	34.G ...

(*) Afhankelijk van de hoogte
Dépend de l'hauteur
Dependent of the height
Von der Höhe abhängig

(**) Afhankelijk van de positie van de primaire vleugel
Dépend de la position de ouvrante principale
depending on the position of the primary vent
abhängig von der Position des primären Fluegel

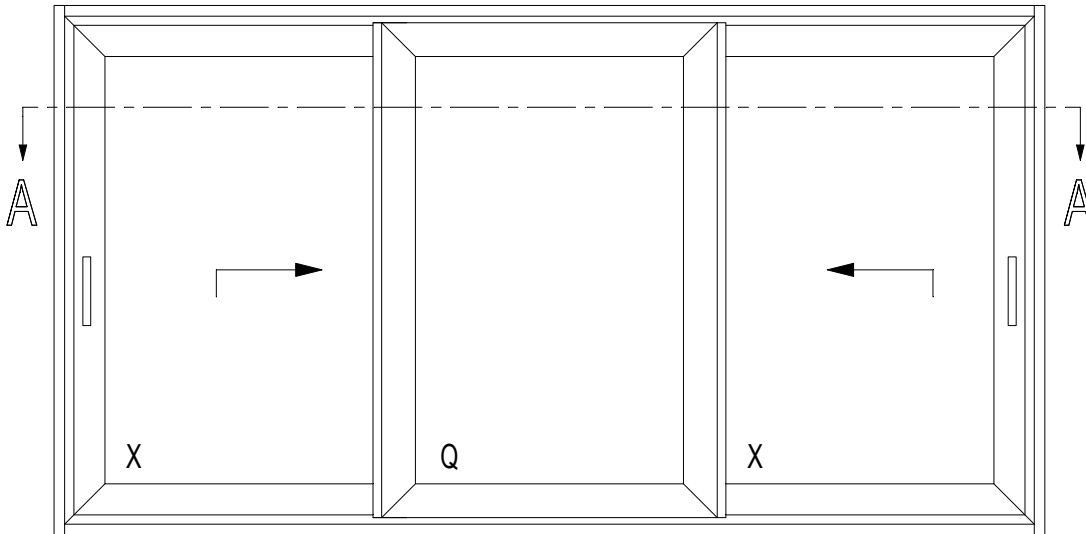

A - A

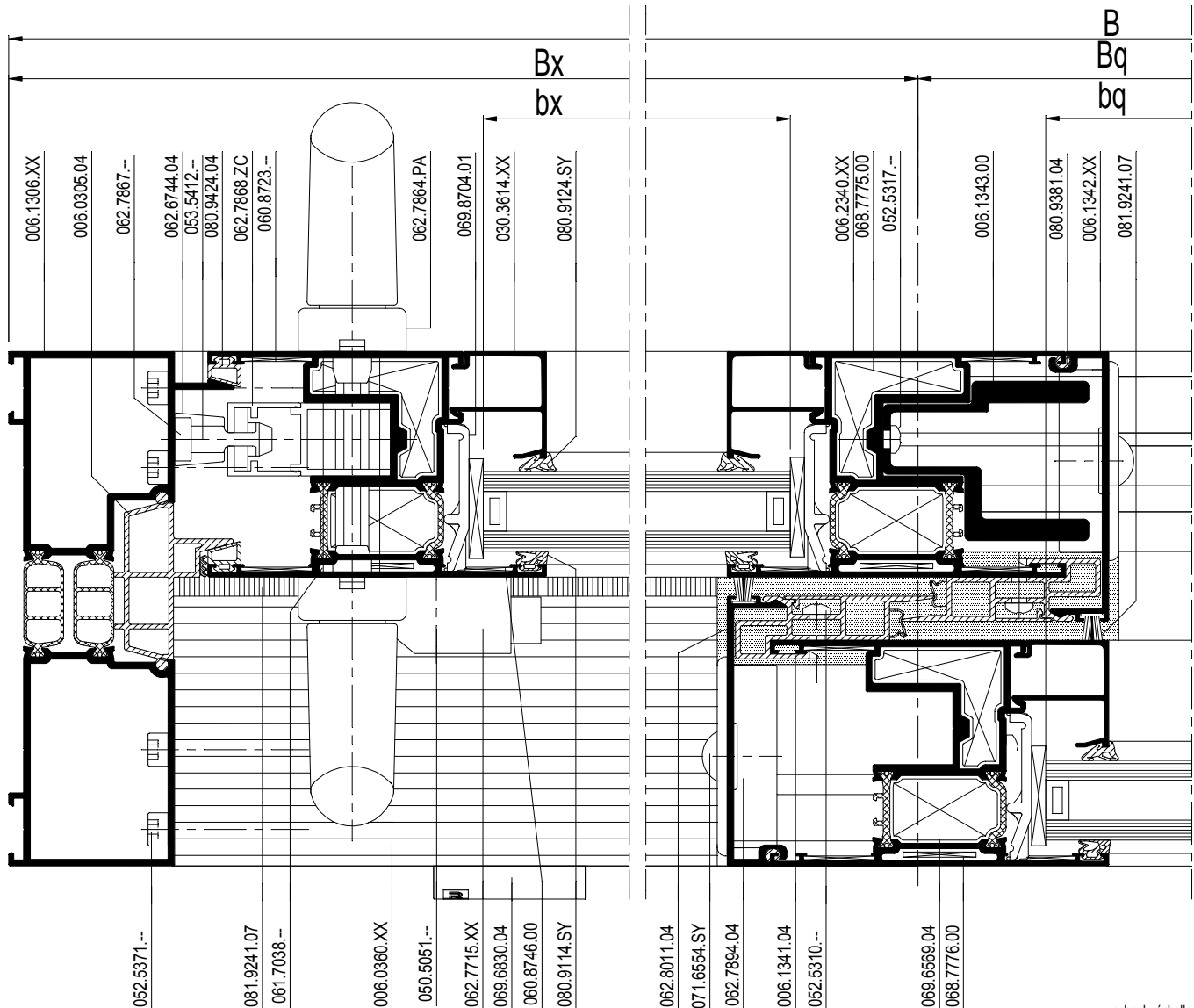

schaal - échelle
 scale - Maßstab
 1/2
 D0013934

	HOOGTE HAUTEUR HEIGHT HOEHE	MIN. 1780 MM
(A)	VLEUGELGEWICHT POIDS DU VANTAIL WEIGHT OF THE VENT FLUEGELGEWICHT	MAX. 300KG
(B)	VLEUGELGEWICHT POIDS DU VANTAIL WEIGHT OF THE VENT FLUEGELGEWICHT	MIN. 300KG MAX. 400KG

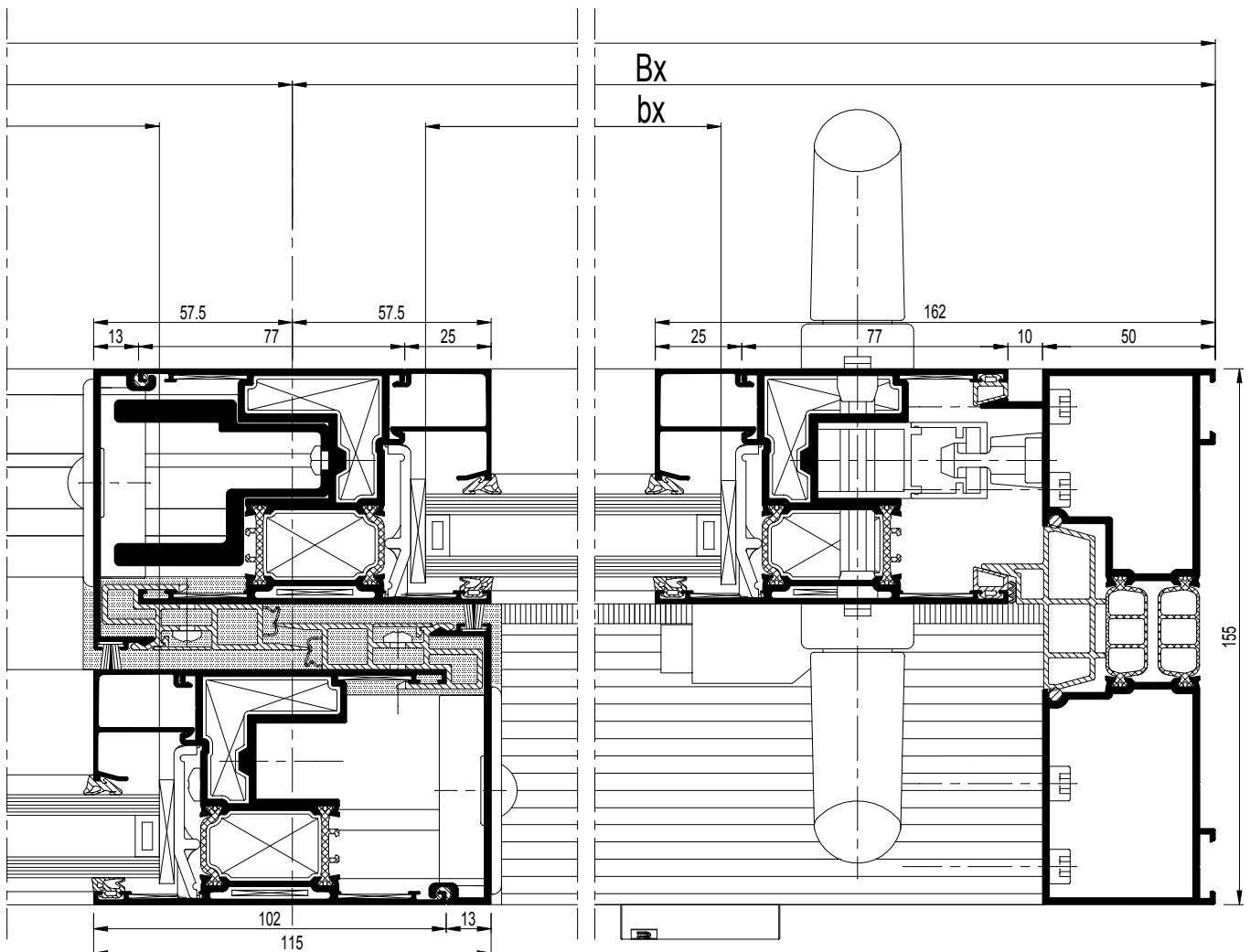

schaal - échelle
 scale - Maßstab
 1/2

D0013934

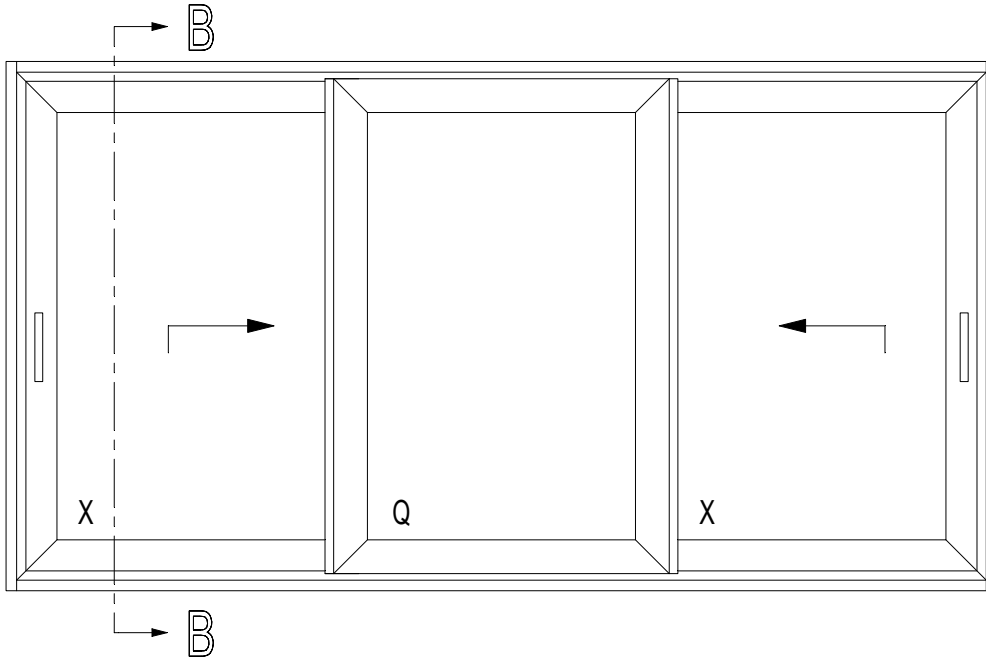

HOOGTE HAUTEUR HEIGHT HOEHE	MIN. 1780 MM
--------------------------------------	--------------

(A) VLEUGELGEWICHT POIDS DU VANTAIL WEIGHT OF THE VENT FLUEGELGEWICHT	MAX. 300KG
--	------------

(B) VLEUGELGEWICHT POIDS DU VANTAIL WEIGHT OF THE VENT FLUEGELGEWICHT	MIN. 300KG MAX. 400KG
--	--------------------------

D0013935

B - B

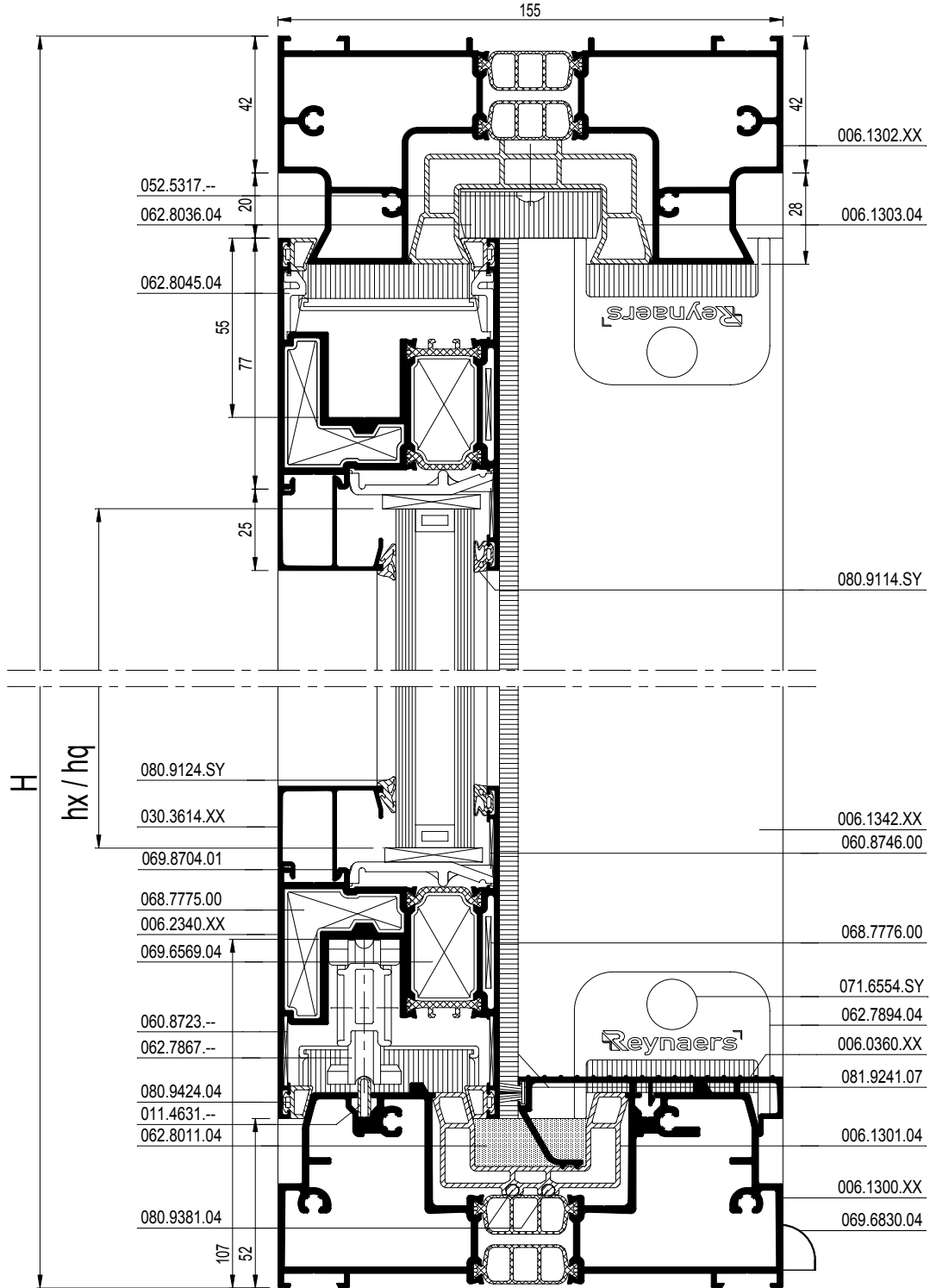

schaal - échelle
 scale - Maßstab
 1/2

D0013935



bx = Bx-181.5
hx = H-280
bq = Bq-77
hq = H-280

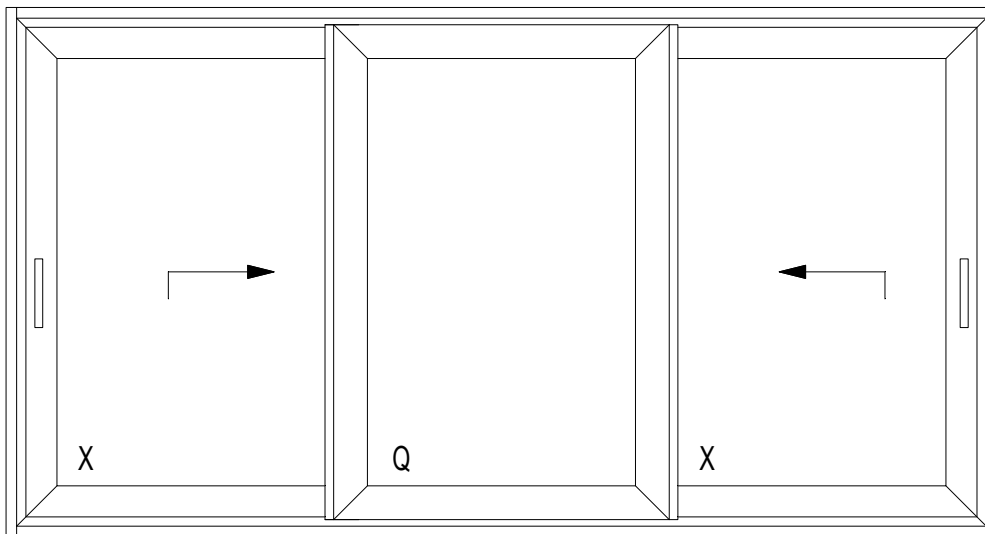

			#	$\leftarrow L_m \rightarrow$	
006.1300.XX 006.1301.04			1	B-100	34.C. ...
006.1302.XX 006.1303.04			1	B-100	34.C. ...
006.1306.XX			2	H	34.C. ...
006.0305.04			2	H - 150	34.C. ...
011.4631.--			1	B-100	34.C. ...
006.2340.XX			4	Bx-15.5	34.C. ...
			2	Bq+89	
			6	H-114	
006.1342.XX			4	H-114	34.C. ...
006.1341.04			4	H-114	34.C. ...
006.1343.00			2	H-172	34.C. ...
030.3614.XX			4	Bx-169.5	34.C. ...
			2	Bq-65	
			6	H-318	
006.0360.XX			2	Bx-110.5	34.C. ...
(A) 0M0.1505.XX			2	Bx-678.5	34.C. ...
(B) 0M0.1505.XX			4	40	34.C. ...
			2	Bx-1302.5	

HOOGTE HAUTEUR HEIGHT HOEHE	MIN. 1780 MM
--------------------------------------	--------------

(A) VLEUGELGEWICHT POIDS DU VANTAIL WEIGHT OF THE VENT FLUEGELGEWICHT	MAX. 300KG
--	------------

(B) VLEUGELGEWICHT POIDS DU VANTAIL WEIGHT OF THE VENT FLUEGELGEWICHT	MIN. 300KG MAX. 400KG
--	--------------------------

D0044956

			#	
			16	34.G. ...
			12	34.G. ...
			12	34.G. ...
			12	34.G. ...
			24	34.G. ...
			12	34.G. ...
			4	34.G. ...
			8	34.G. ...
			8	34.G. ...
			4	34.G. ...
(*)			2	34.G. ...
			2	34.G. ...
			4	34.G. ...
			4	34.G. ...
			2	34.G. ...
			2	34.G. ...
(A)			2	34.G. ...
			2	34.G. ...
(B)			4	34.G. ...
			4	34.G. ...
			4	34.G. ...
(A)			2	34.G. ...
(B)			2	34.G. ...
			2	34.G. ...
			3	34.G. ...
			3	34.G. ...
			3	34.G. ...
			2	34.G. ...
			2	34.G. ...
			4	34.G. ...
			1	34.G. ...
			1	34.G. ...
			2	34.G. ...
			4xH (3/m)	34.G. ...
			2xH (3/m)	34.G. ...
(A)			24 (-250KG)	34.G. ...
(A)			18 (+250KG)	34.G. ...
			6	34.G. ...
(B)			18	34.G. ...
			12	34.G. ...
			2	34.G. ...
			min. 2	34.G. ...
			(2xB)+(6xH)	34.G. ...
			(2xB)+(6xH)	34.G. ...
			(2xB)+(6xH)	34.G. ...
			(4xB)+(4xH)	34.G. ...
			(4xH)+(2xBx)	34.G. ...

VARIANT HI

080.9439.04		(2xBx)+(4xH)	34.G. ...
080.9625.07		(2xB)+(6xH)	34.G. ...

(*) Afhankelijk van de hoogte
Dépend de l'hauteur
Dependent of the height
Von der Höhe abhängig

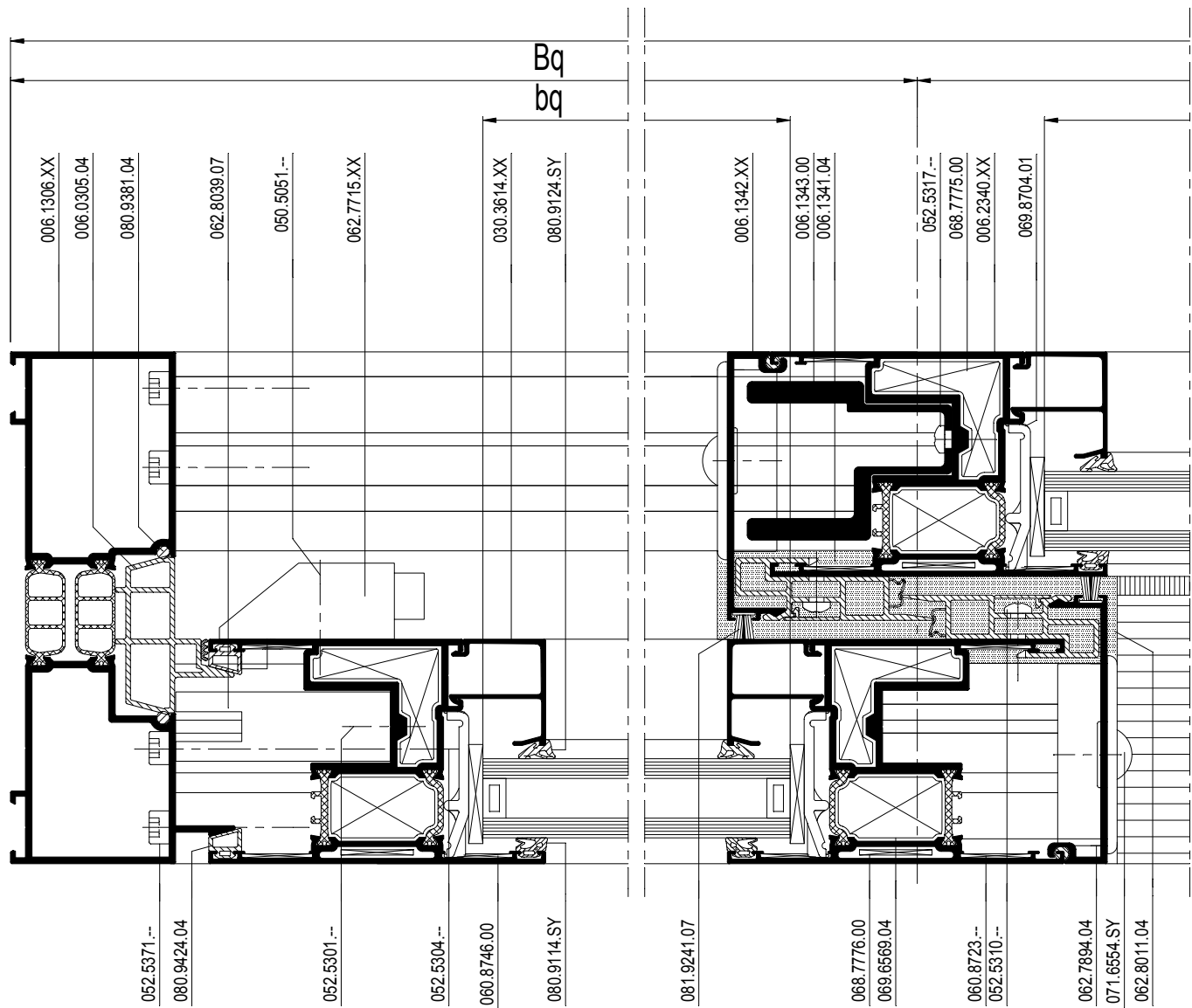
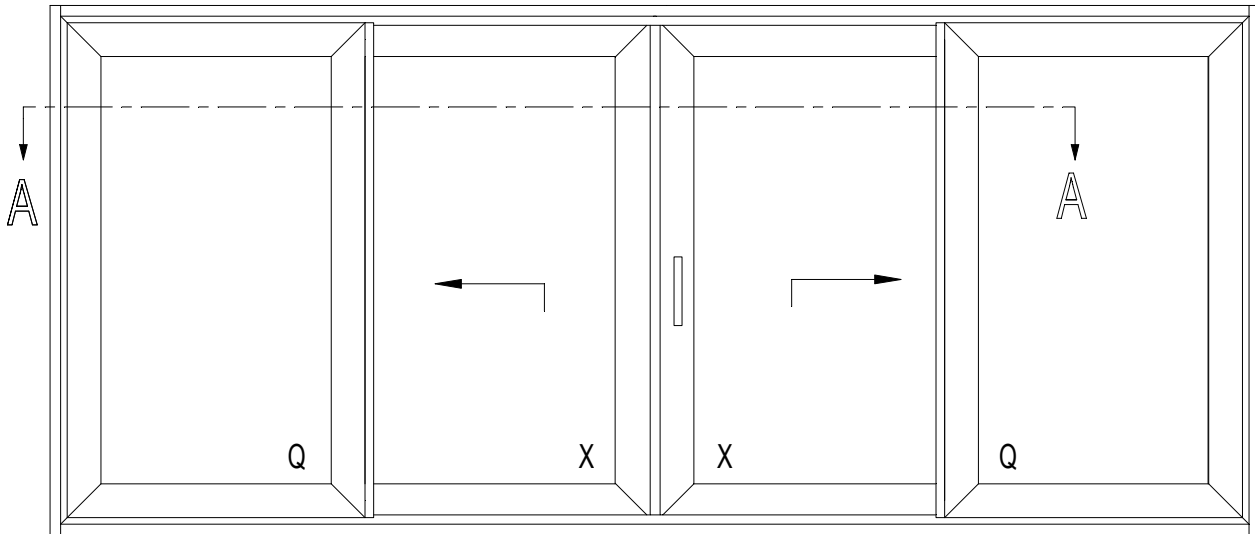

schaal - échelle
 scale - Maßstab
 1/2
 D0013936

	HOOGTE HAUTEUR HEIGHT HOEHE	MIN. 1780 MM
(A)	VLEUGELGEWICHT POIDS DU VANTAIL WEIGHT OF THE VENT FLUEGELGEWICHT	MAX. 300KG
(B)	VLEUGELGEWICHT POIDS DU VANTAIL WEIGHT OF THE VENT FLUEGELGEWICHT	MIN. 300KG MAX. 400KG

A - A

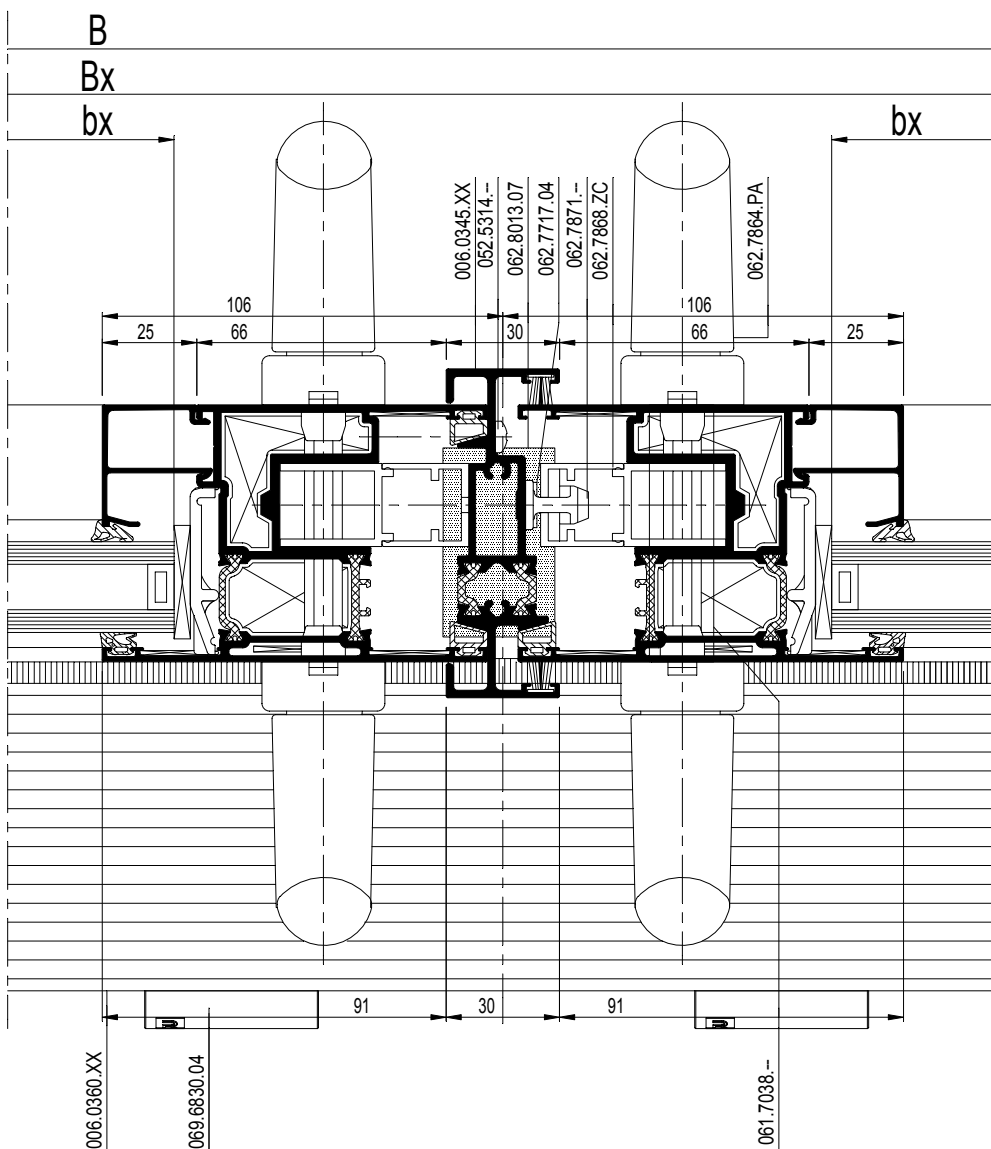

schaal - échelle
 scale - Maßstab
 1/2

D0013936

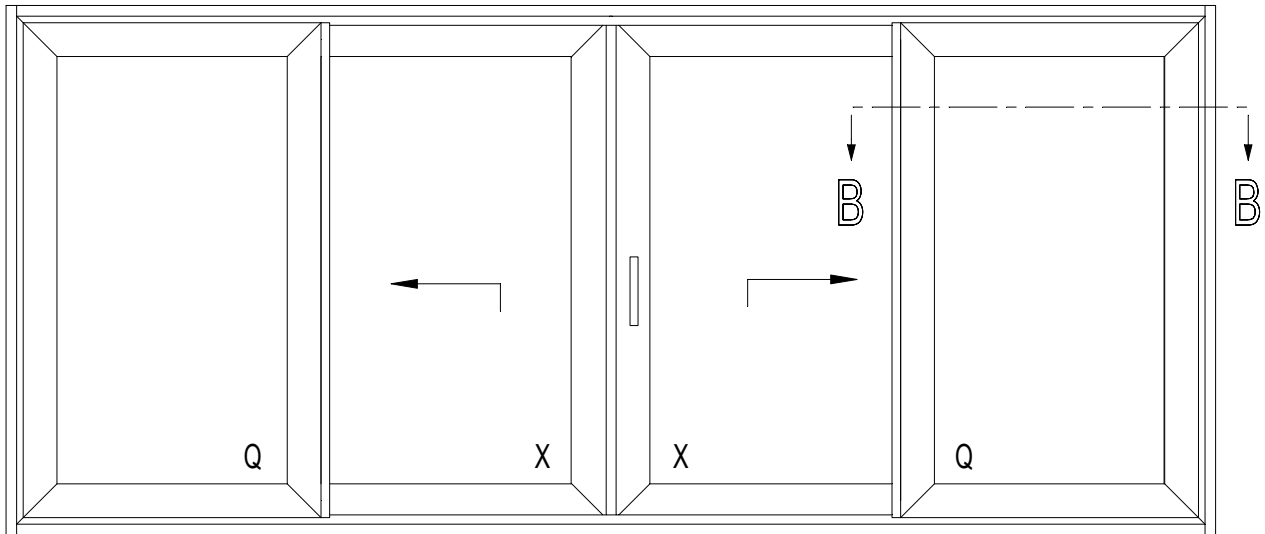

B - B

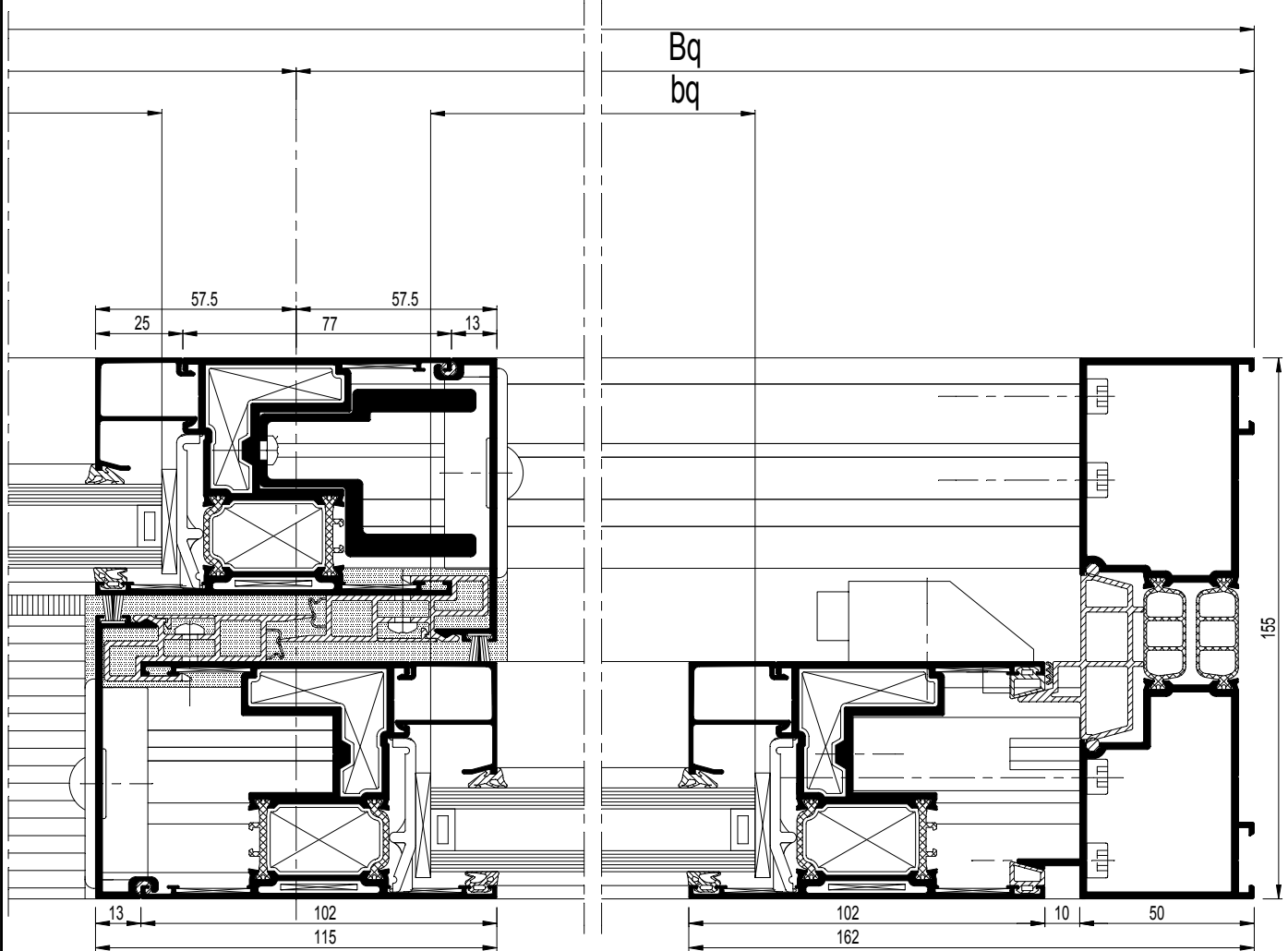

schaal - échelle
 scale - Maßstab
 1/2
 D0013937

			#	
			16	34.G. ...
			16	34.G. ...
			16	34.G. ...
			16	34.G. ...
			32	34.G. ...
			16	34.G. ...
			4	34.G. ...
			8	34.G. ...
			8	34.G. ...
			4	34.G. ...
(*)			2	34.G. ...
	<small>OF-OU-OR-ODER</small>			
			2	34.G. ...
			2	34.G. ...
			2	34.G. ...
			1	34.G. ...
(A)			2	34.G. ...
			2	34.G. ...
(B)			4	34.G.
			4	34.G.
			4	34.G.
(A)			2	34.G. ...
(B)			2	34.G. ...
			2	34.G. ...
			2	34.G. ...
			6	34.G.
			6	34.G.
			6	34.G.
			6	34.G.
			6	34.G.
			6	34.G.

			#	
			2	34.G. ...
			1	34.G. ...
			4	34.G. ...
			2	34.G. ...
			4	34.G. ...
			1	34.G. ...
			1	34.G. ...
			2	34.G. ...
			4xH (3/m)	34.G. ...
			2xH (3/m)	34.G. ...
			H (3/m)	34.G. ...
(A)			32 (-250KG)	34.G. ...
(A)			24 (+250KG)	34.G. ...
			8	34.G. ...
(B)			24	34.G. ...
			16	34.G. ...
			2	34.G. ...
			min. 2	34.G. ...
			(2xB)+(8xH)	34.G. ...
			(2xB)+(8xH)	34.G. ...
			(2xB)+(8xH)	34.G. ...
			(4xB)+(7xH)	34.G. ...
			(6xH)+Bx	34.G. ...

VARIANT HI

		(1xBx)+(6xH)	34.G. ...
		(2xB)+(8xH)	34.G. ...

(A)	VLEUGELGEWICHT POIDS DU VANTAIL WEIGHT OF THE VENT FLUEGELGEWICHT	MAX. 300KG
-----	--	------------

(B)	VLEUGELGEWICHT POIDS DU VANTAIL WEIGHT OF THE VENT FLUEGELGEWICHT	MIN. 300KG MAX. 400KG
-----	--	--------------------------

	HOOGTE HAUTEUR HEIGHT HOEHE	MIN. 1780 MM
--	--------------------------------------	--------------

(*) Afhankelijk van de hoogte
Dépend de l'hauteur
Dependent of the height
Von der Höhe abhängig

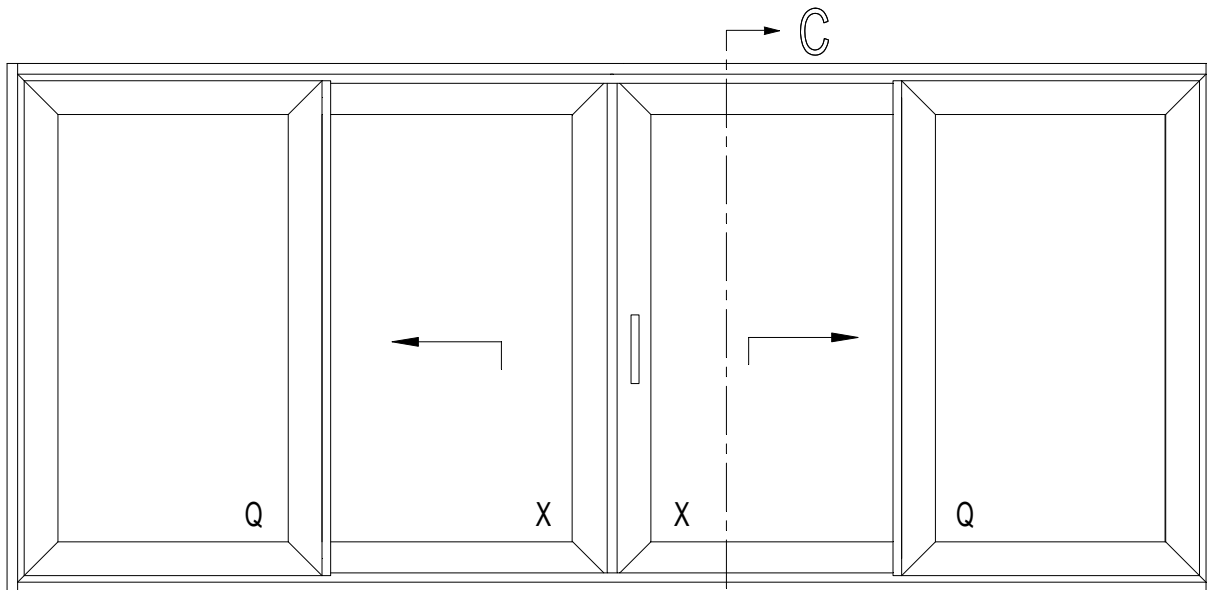

			#	L_m	
006.1300.XX 006.1301.04			1	B-100	34.C. ...
006.1302.XX 006.1303.04			1	B-100	34.C. ...
006.1306.XX			2	H	34.C. ...
006.0305.04			2	H - 150	34.C. ...
011.4631.--			1	B-100	34.C. ...
006.2340.XX			4	$(Bx:2)+40.5$	34.C. ...
			4	Bq-15.5	
			8	H-114	
006.1342.XX			4	H-114	34.C. ...
006.1341.04			4	H-114	34.C. ...
006.1343.00			2	H-172	34.C. ...
006.0345.XX			1	H-114	34.C. ...
030.3614.XX			4	$(Bx:2)-113.5$	34.C. ...
			4	Bq-169.5	
			8	H-318	
006.0360.XX			1	Bx-121	34.C. ...
(A) 0M0.1505.XX			2	$(Bx:2)-622.5$	34.C. ...
(B) 0M0.1505.XX			4	40	34.C. ...
			2	$(Bx:2)-1246.5$	

$bx = (Bx:2)-125.5$
$hx = H-280$
$bq = Bq-181.5$
$hq = H-280$

HOOGTE HAUTEUR HEIGHT HOEHE	MIN. 1780 MM
--------------------------------------	--------------

(A) VLEUGELGEWICHT POIDS DU VANTAIL WEIGHT OF THE VENT FLUEGELGEWICHT	MAX. 300KG
--	------------

(B) VLEUGELGEWICHT POIDS DU VANTAIL WEIGHT OF THE VENT FLUEGELGEWICHT	MIN. 300KG MAX. 400KG
--	--------------------------

D0013938

C - C

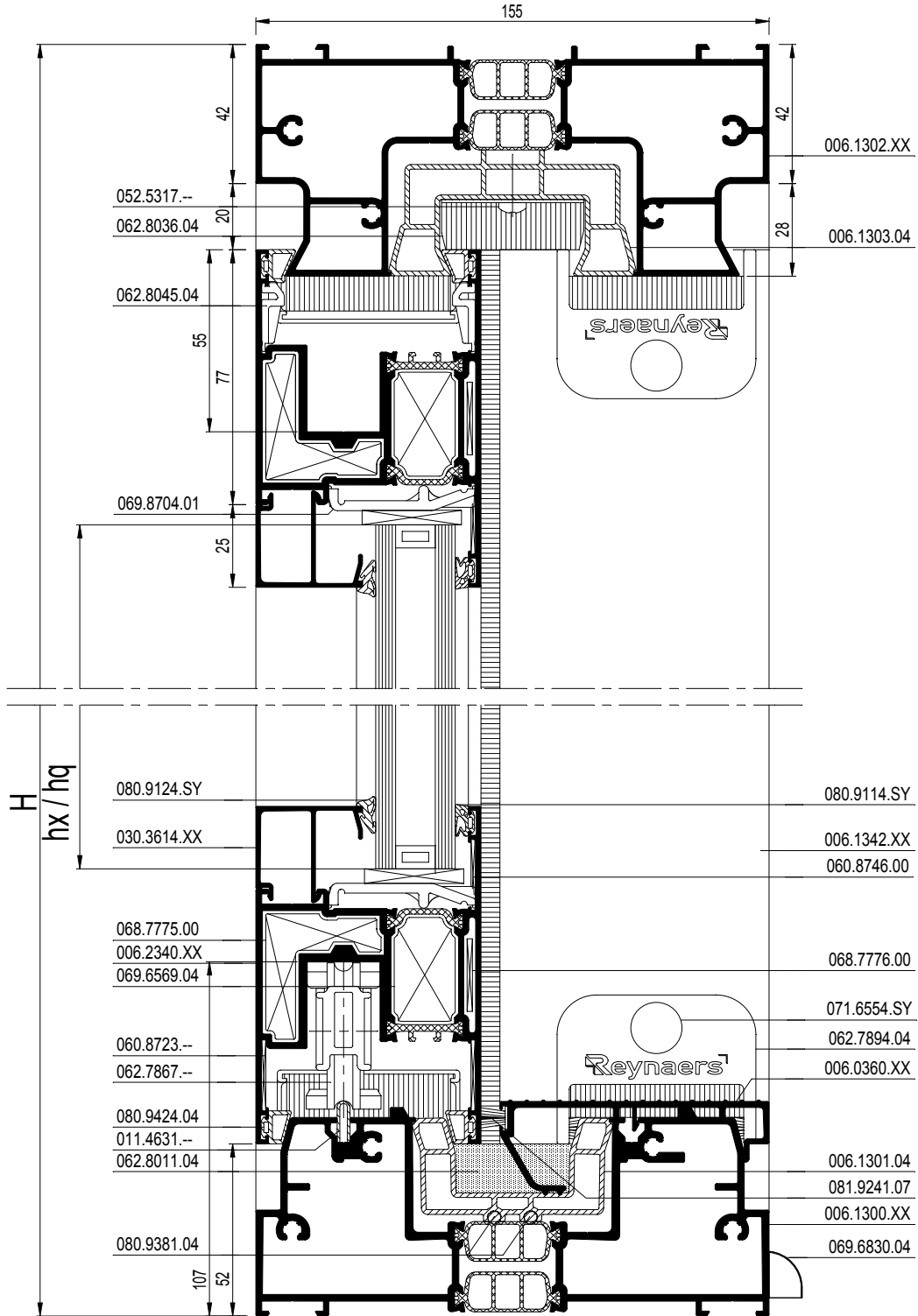

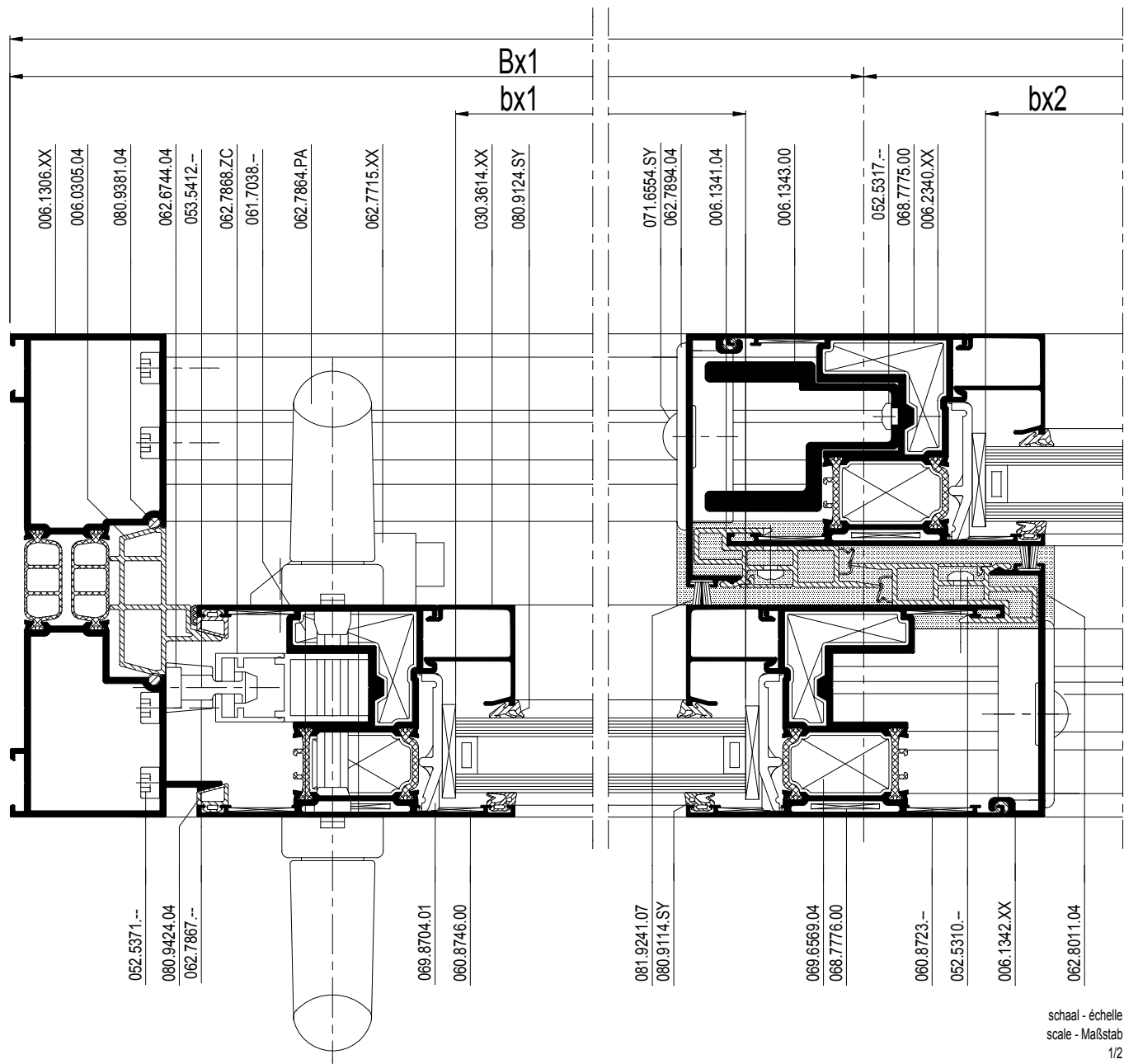
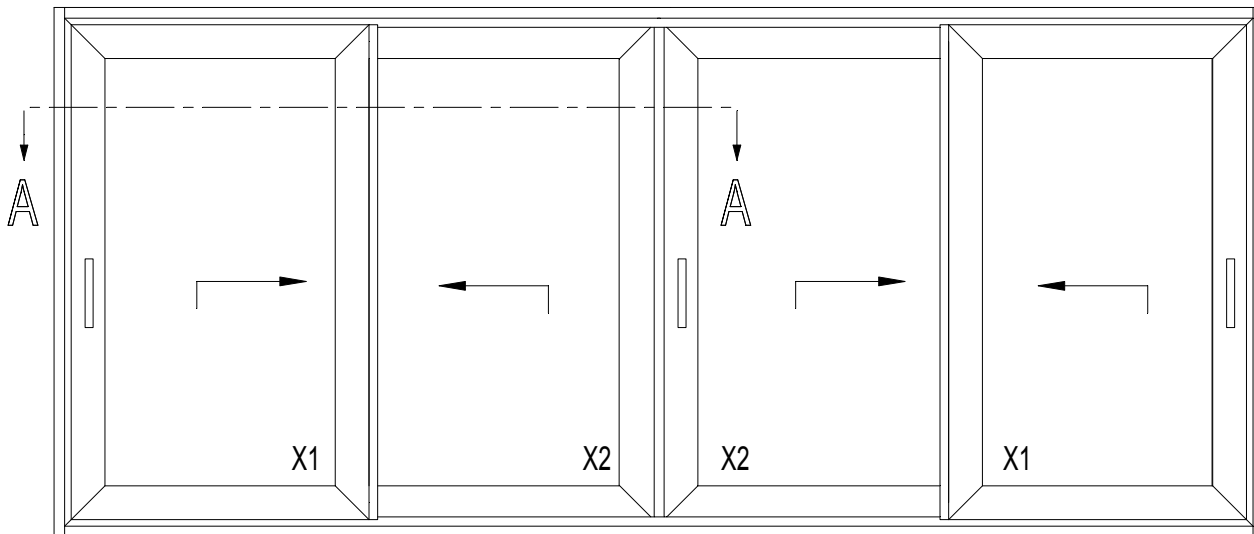

schaal - échelle
 scale - Maßstab
 1/2
 D0013939

HOOGTE HAUTEUR HEIGHT HOEHE	MIN. 1780 MM
--------------------------------------	--------------

(A) VLEUGELGEWICHT POIDS DU VANTAIL WEIGHT OF THE VENT FLUEGELGEWICHT	MAX. 300KG
--	------------

(B) VLEUGELGEWICHT POIDS DU VANTAIL WEIGHT OF THE VENT FLUEGELGEWICHT	MIN. 300KG MAX. 400KG
--	--------------------------

A - A

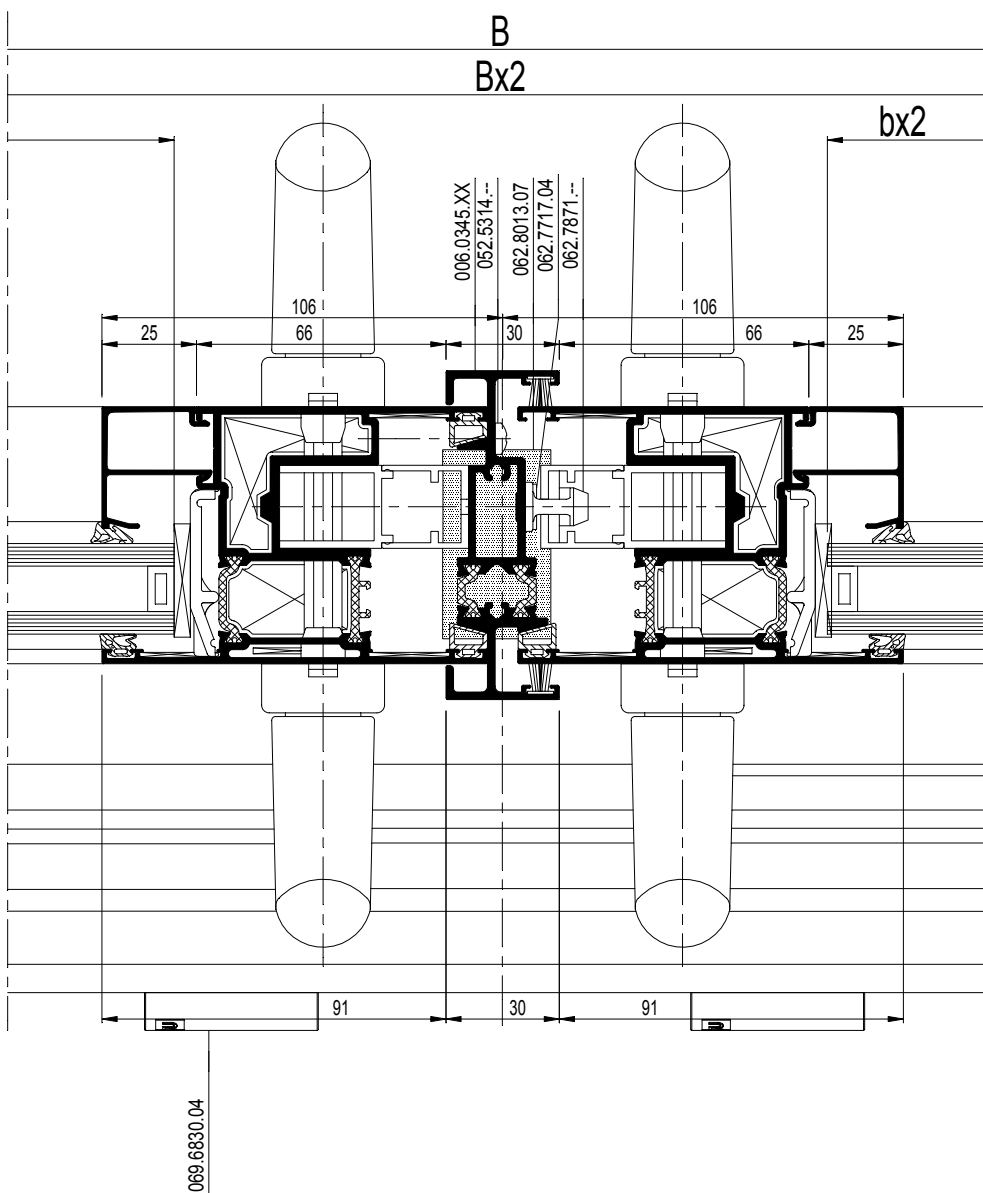

schaal - échelle
 scale - Maßstab
 1/2

D0013939

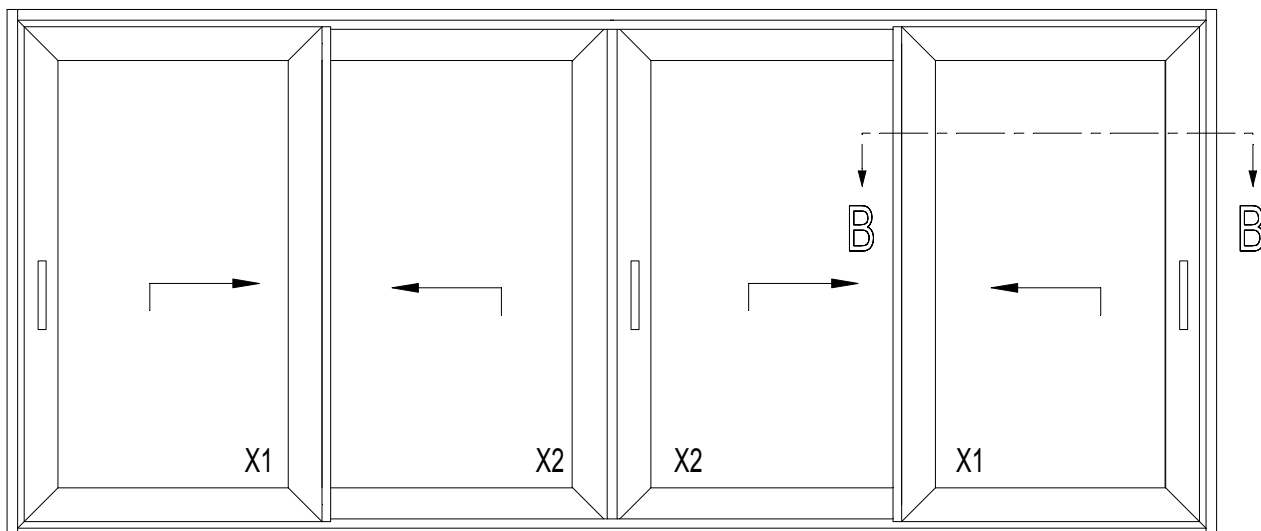

B - B

Bx1

bx1

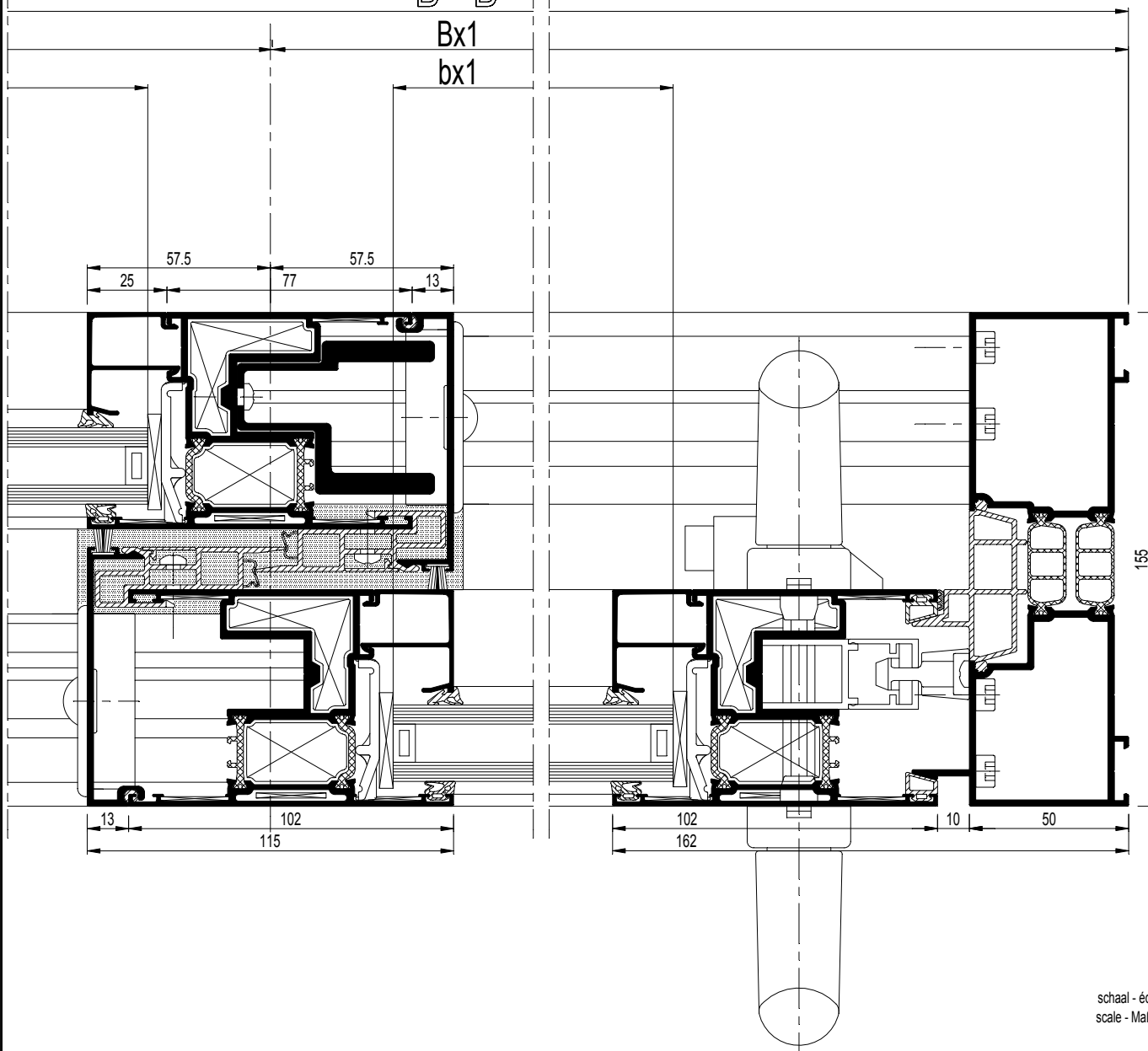

schaal - échelle
 scale - Maßstab
 1/2
 D0013940

			#	
			16	34.G. ...
			16	34.G. ...
			16	34.G. ...
			16	34.G. ...
			32	34.G. ...
			16	34.G. ...
			4	34.G. ...
			8	34.G. ...
			8	34.G. ...
			8	34.G. ...
(*)			4	34.G. ...
			4	34.G. ...
			1	34.G. ...
			4	34.G. ...
(A)			2	34.G. ...
			2	34.G. ...
(B)			4	34.G. ...
			4	34.G. ...
			4	34.G. ...
(A)			4	34.G. ...
(B)			4	34.G. ...
			4	34.G. ...
			4	34.G. ...
			2	34.G. ...
			4	34.G. ...
			4	34.G. ...
			4	34.G. ...

			#	
			2	34.G. ...
			2	34.G. ...
			4	34.G. ...
			1	34.G. ...
			4	34.G. ...
			1	34.G. ...
			1	34.G. ...
			2	34.G. ...
			4xH (3/m)	34.G. ...
			2xH (3/m)	34.G. ...
			H (3/m)	34.G. ...
(A)			32 (-250KG)	34.G. ...
(A)			24 (+250KG)	34.G. ...
			8	34.G. ...
(B)			24	34.G. ...
			16	34.G. ...
			2	34.G. ...
			min. 2	34.G. ...
			(2xB)+(8xH)	34.G. ...
			(2xB)+(8xH)	34.G. ...
			(2xB)+(8xH)	34.G. ...
			(4xB)+(7xH)	34.G. ...
			6xH	34.G. ...

VARIANT HI

			(1xB)+(6xH)	34.G. ...
			(2xB)+(8xH)	34.G. ...

(A)	VLEUGELGEWICHT POIDS DU VANTAIL WEIGHT OF THE VENT FLUEGELGEWICHT	MAX. 300KG
-----	--	------------

(B)	VLEUGELGEWICHT POIDS DU VANTAIL WEIGHT OF THE VENT FLUEGELGEWICHT	MIN. 300KG MAX. 400KG
-----	--	--------------------------

	HOOGTE HAUTEUR HEIGHT HOEHE	MIN. 1780 MM
--	--------------------------------------	--------------

(*) Afhankelijk van de hoogte
Dépend de l'hauteur
Dependent of the height
Von der Höhe abhängig

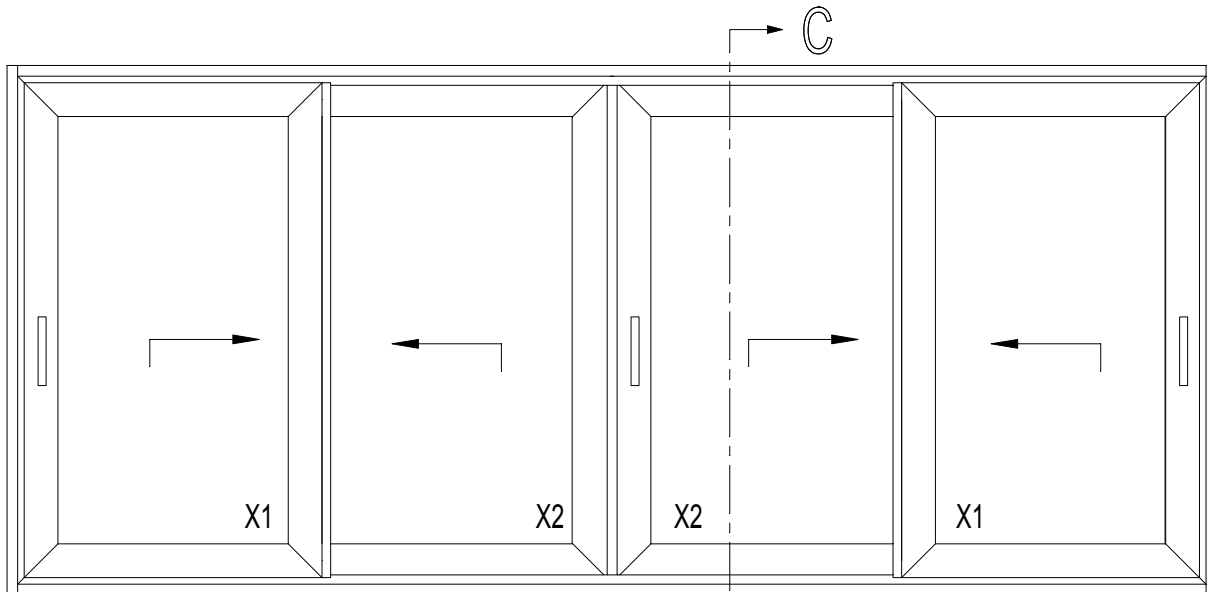

			#	L_m	
006.1300.XX 006.1301.04			1	B-100	34.C. ...
006.1302.XX 006.1303.04			1	B-100	34.C. ...
006.1306.XX			2	H	34.C. ...
006.0305.04			2	H - 150	34.C. ...
011.4631.--			2	B-100	34.C. ...
006.2340.XX			4	$(Bx2:2)+40.5$	34.C. ...
			4	$Bx1-15.5$	
			8	H-114	
006.1342.XX			4	H-114	34.C. ...
006.1341.04			4	H-114	34.C. ...
006.1343.00			2	H-172	34.C. ...
006.0345.XX			1	H-114	34.C. ...
030.3614.XX			4	$(Bx2:2)-113.5$	34.C. ...
			4	$Bx1-169.5$	
			8	H-318	
(A) 0M0.1505.XX			2	$(Bx2:2)-622.5$	34.C. ...
			2	$Bx1-678.5$	
(B) 0M0.1505.XX			2	$(Bx2:2)-1246.5$	34.C. ...
			2	$Bx1-1302.5$	

$bx2 = (Bx2:2)-125.5$
$hx2 = H-280$
$bx1 = Bx1-181.5$
$hx1 = H-280$

HOOGTE HAUTEUR HEIGHT HOEHE	MIN. 1780MM
--------------------------------------	-------------

(A) VLEUGELGEWICHT POIDS DU VANTAIL WEIGHT OF THE VENT FLUEGELGEWICHT	MAX. 300KG
--	------------

(B) VLEUGELGEWICHT POIDS DU VANTAIL WEIGHT OF THE VENT FLUEGELGEWICHT	MIN. 300KG MAX. 400KG
--	--------------------------

D0013941

C - C

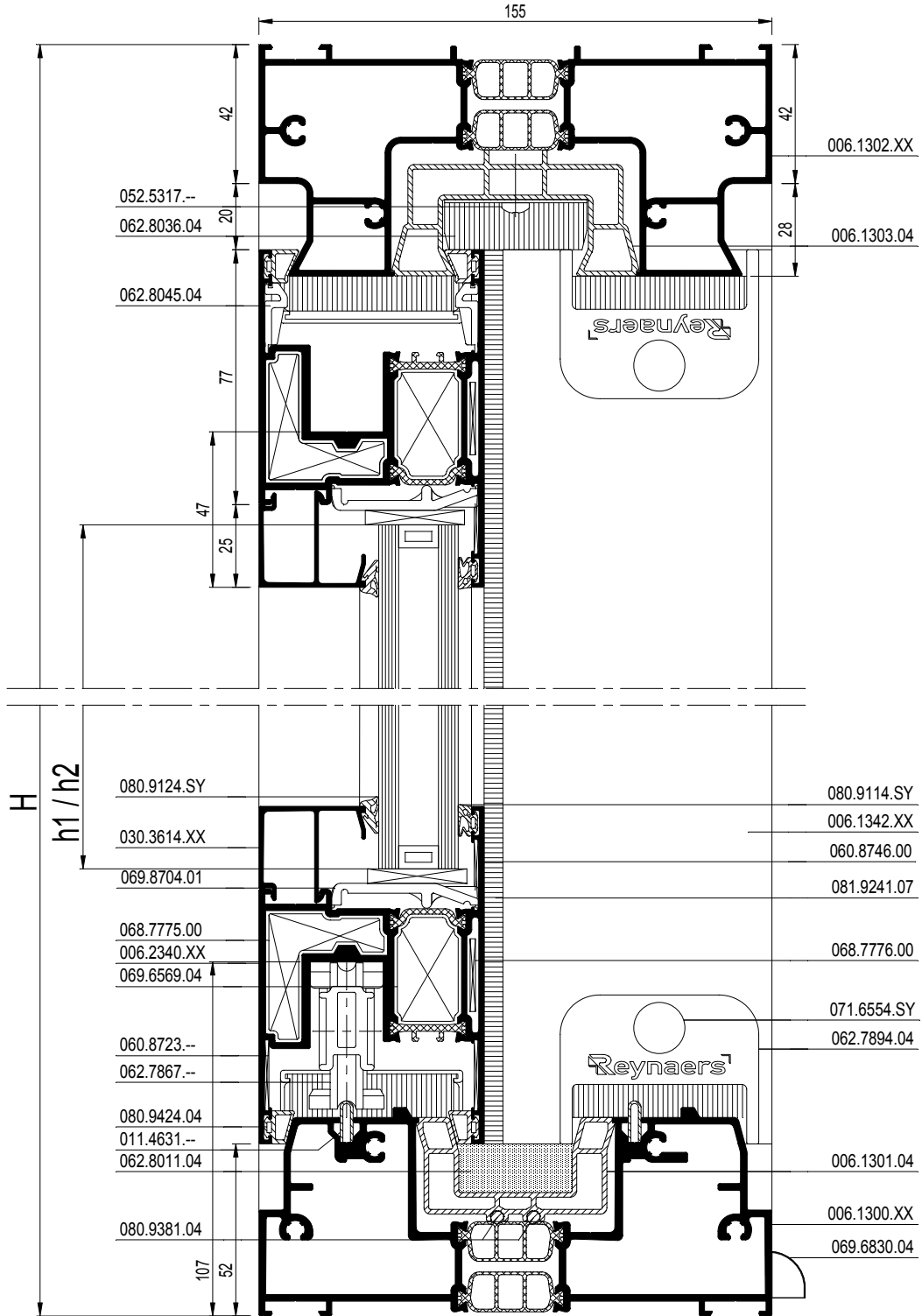

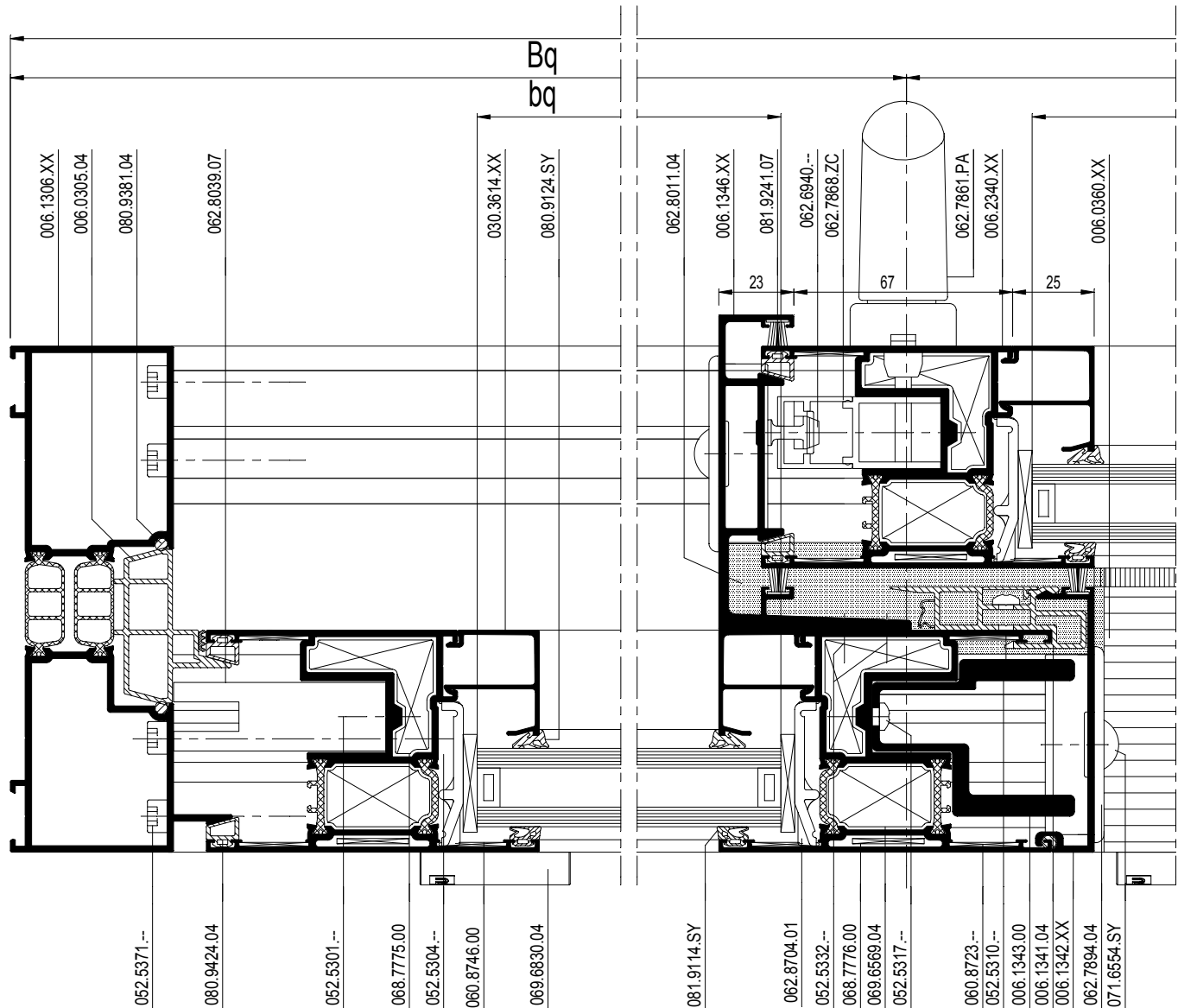
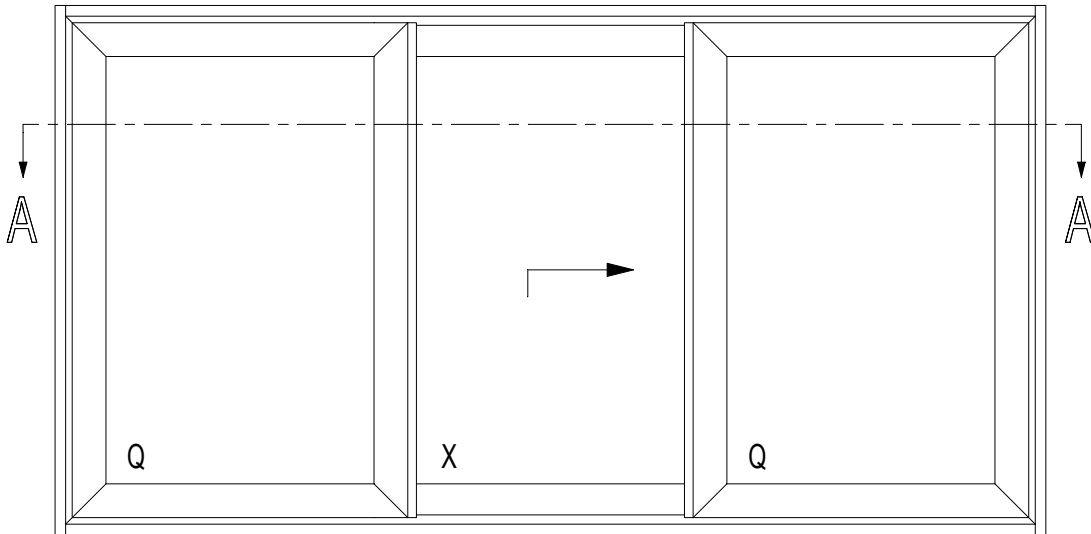

schaal - échelle
 scale - Maßstab
 1/2
 D0046860

HOOGTE HAUTEUR HEIGHT HOEHE	MIN. 1780 MM
--------------------------------------	--------------

(A) VLEUGELGEWICHT POIDS DU VANTAIL WEIGHT OF THE VENT FLUEGELGEWICHT	MAX. 300KG
--	------------

(B) VLEUGELGEWICHT POIDS DU VANTAIL WEIGHT OF THE VENT FLUEGELGEWICHT	MIN. 300KG MAX. 400KG
--	--------------------------

A - A

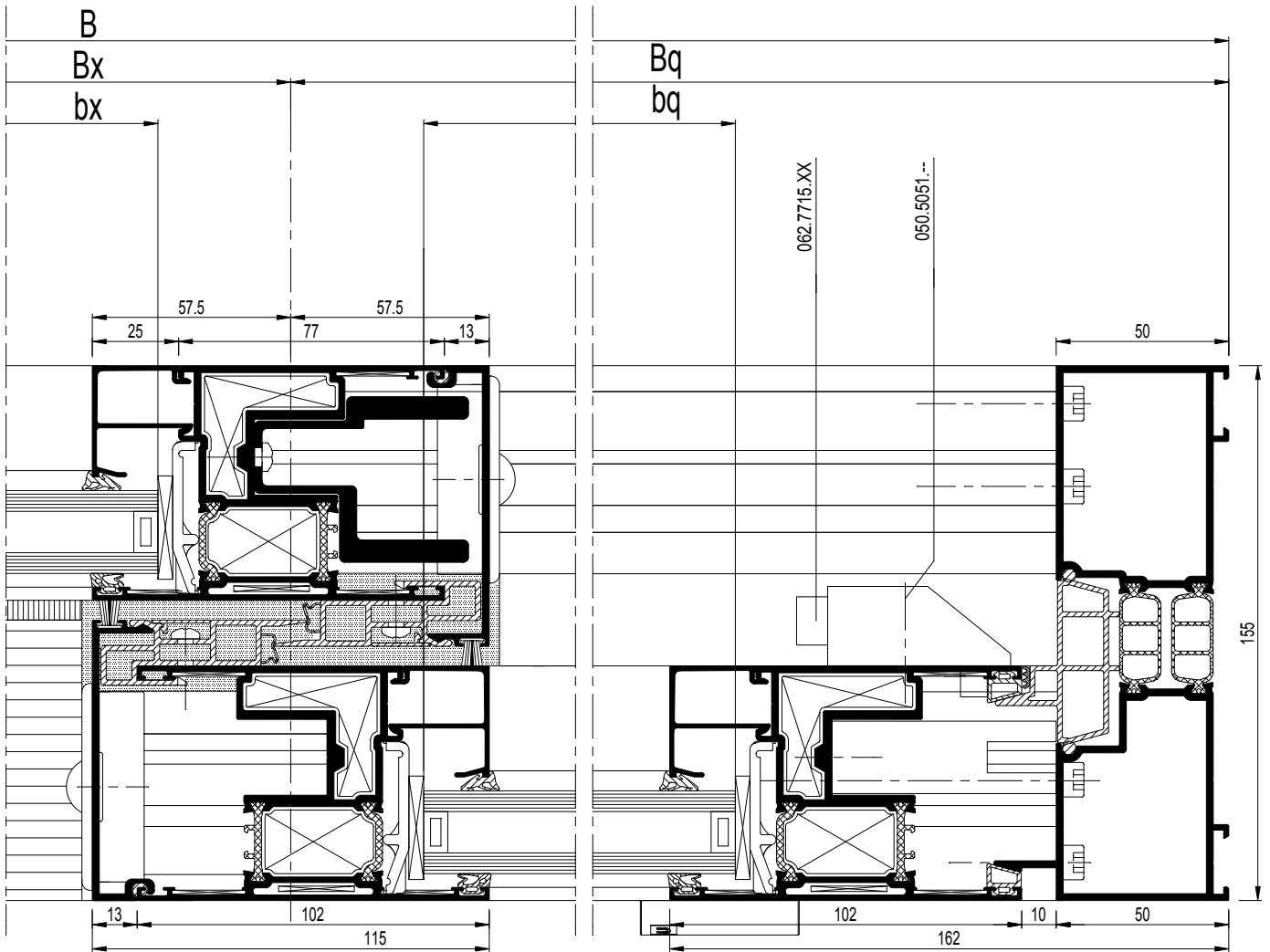

schaal - échelle
 scale - Maßstab
 1/2

D0046860

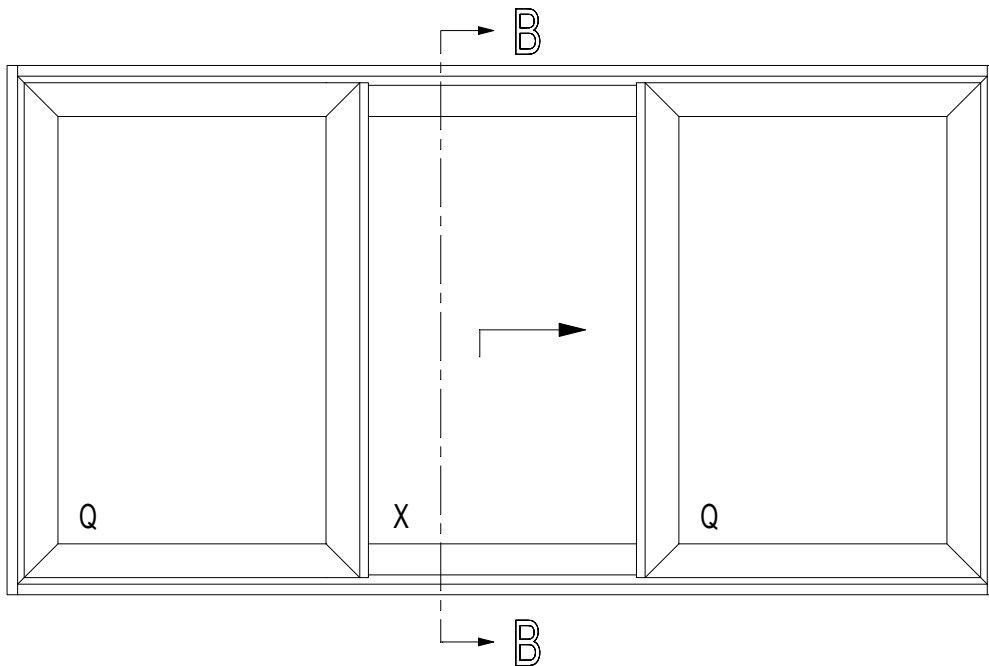

HOOGTE HAUTEUR HEIGHT HOEHE	MIN. 1780 MM
--------------------------------------	--------------

(A) VLEUGELGEWICHT POIDS DU VANTAIL WEIGHT OF THE VENT FLUEGELGEWICHT	MAX. 300KG
--	------------

(B) VLEUGELGEWICHT POIDS DU VANTAIL WEIGHT OF THE VENT FLUEGELGEWICHT	MIN. 300KG MAX. 400KG
--	--------------------------

B - B

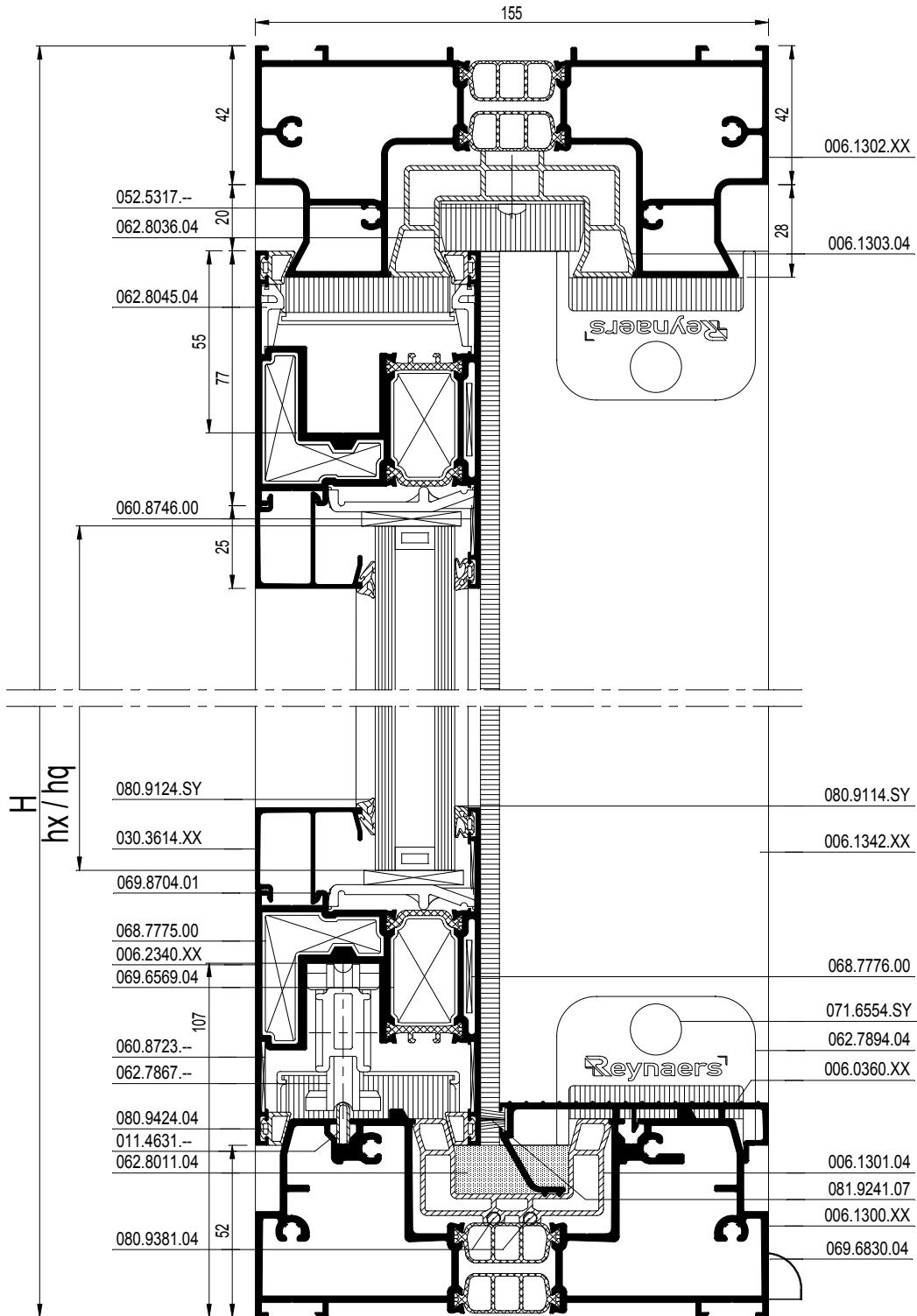

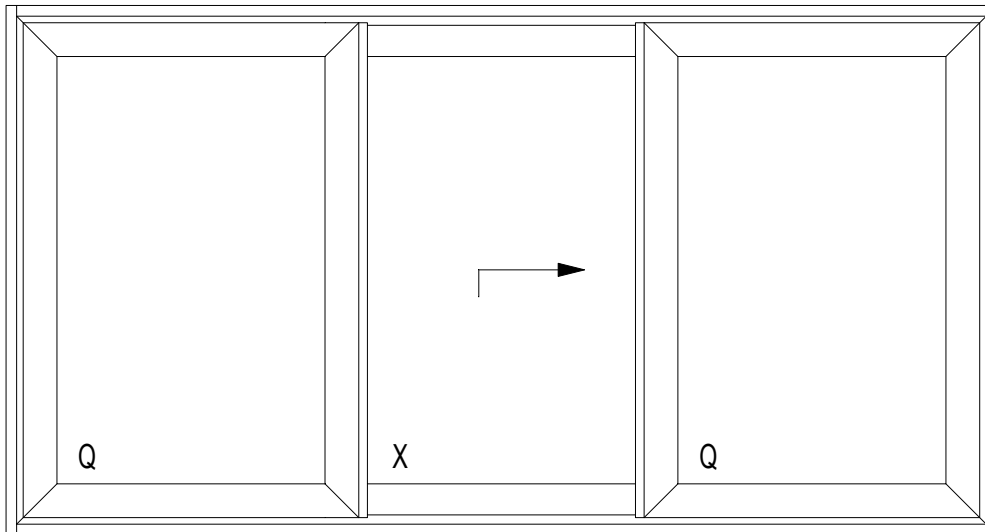

			#	L_m	
006.1300.XX 006.1301.04			1	B-100	34.C. ...
006.1302.XX 006.1303.04			1	B-100	34.C. ...
006.1306.XX			2	H	34.C. ...
006.0305.04			2	H - 150	34.C. ...
011.4631.--			1	B-100	34.C. ...
006.2340.XX			2	Bx+89	34.C. ...
			4	Bq-15.5	
			6	H-114	
006.1342.XX			3	H-114	34.C. ...
006.1346.XX			1	H-114	34.C. ...
006.1341.04			3	H-114	34.C. ...
006.1343.00			2	H-171	34.C. ...
030.3614.XX			2	Bx-65	34.C. ...
			4	Bq-169.5	
			6	H-318	
006.0360.XX			1	Bx-121	34.C. ...
(A) 0M0.1505.XX			1	Bx-574	34.C. ...
(B) 0M0.1505.XX			2	40	34.C. ...
			1	Bx-1198	34.C. ...



















































bx = Bx-77
hx = H-280
bq = Bq-181.5
hq = H-280















































HOOGTE HAUTEUR HEIGHT HOEHE	MIN. 1895 MM
--------------------------------------	--------------

(A) VLEUGELGEWICHT POIDS DU VANTAIL WEIGHT OF THE VENT FLUEGELGEWICHT	MAX. 300KG
--	------------



(B) VLEUGELGEWICHT POIDS DU VANTAIL WEIGHT OF THE VENT FLUEGELGEWICHT	MIN. 300KG MAX. 400KG
--	--------------------------

schaal - échelle
 scale - Maßstab
 1/2
 D0084631

			#	
			16	34.G. ...
			12	34.G. ...
			12	34.G. ...
			12	34.G. ...
			24	34.G. ...
			12	34.G. ...
			4	34.G. ...
			8	34.G. ...
			8	34.G. ...
			2	34.G. ...
(*)			1	34.G. ...
			1	34.G. ...
			1	34.G. ...
(A)			1	34.G. ...
			1	34.G. ...
(B)			2	34.G.
			2	34.G.
			2	34.G.
(A)			1	34.G. ...
(B)			1	34.G. ...
			1	34.G. ...
			6	34.G.
			6	34.G.
			6	34.G.

			#	
			2	34.G. ...
			2	34.G. ...
			4	34.G. ...
			1	34.G. ...
			1	34.G. ...
			2	34.G. ...
			3xH (3/m)	34.G. ...
			2xH (3/m)	34.G. ...
			2xH (6/m)	34.G. ...
			2	34.G. ...
(A)			24 (-250KG)	34.G. ...
(A)			18 (+250KG)	34.G. ...
			6	34.G. ...
(B)			18	34.G. ...
			12	34.G. ...
			2	34.G. ...
			min. 2	34.G. ...
			(2xB)+(6xH)	34.G. ...
			(2xB)+(6xH)	34.G. ...
			(2xB)+(7xH)	34.G. ...
			(4xB)+(6xH)	34.G. ...
			(5xH)+(Bx)	34.G. ...

VARIANT HI

080.9439.04		(1xB)+(4xH)	34.G. ...
080.9625.07		(2xB)+(6xH)	34.G. ...

(*) Afhankelijk van de hoogte
Dépend de l'hauteur
Dependent of the height
Von der Höhe abhängig

D0084631

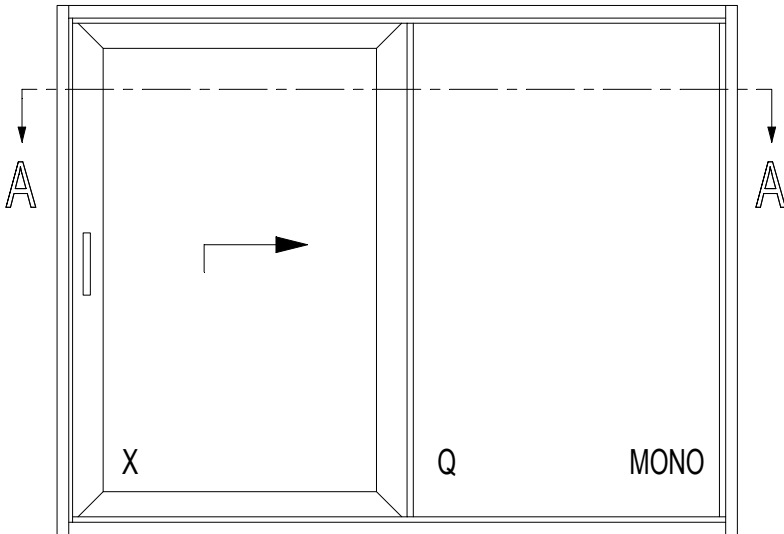

HOOGTE HAUTEUR HEIGHT HOEHE	MIN. 1780 MM
--------------------------------------	--------------

(A) VLEUGELGEWICHT POIDS DU VANTAIL WEIGHT OF THE VENT FLUEGELGEWICHT	MAX. 300KG
--	------------

(B) VLEUGELGEWICHT POIDS DU VANTAIL WEIGHT OF THE VENT FLUEGELGEWICHT	MIN. 300KG MAX. 400KG
--	--------------------------

A - A

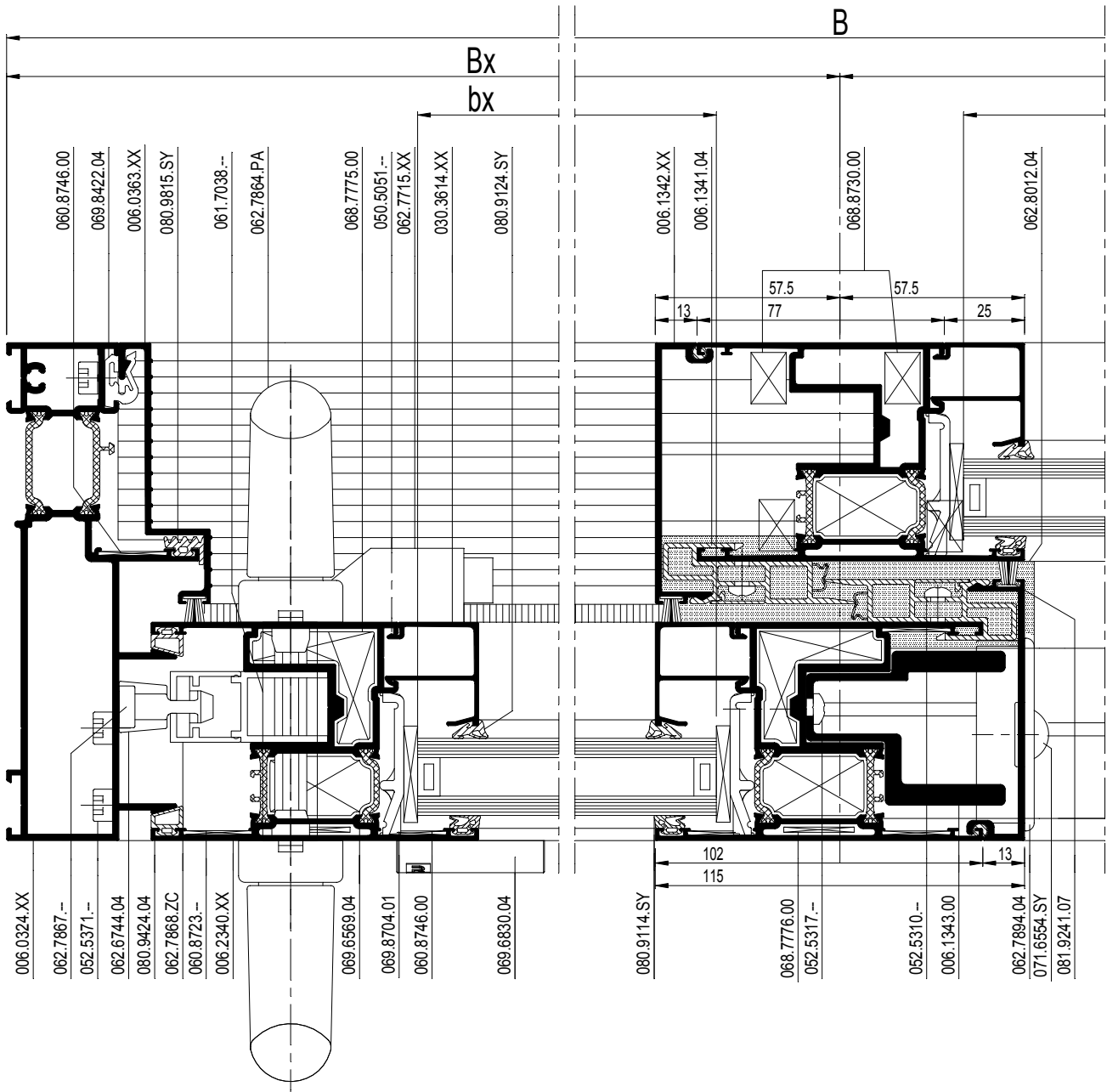

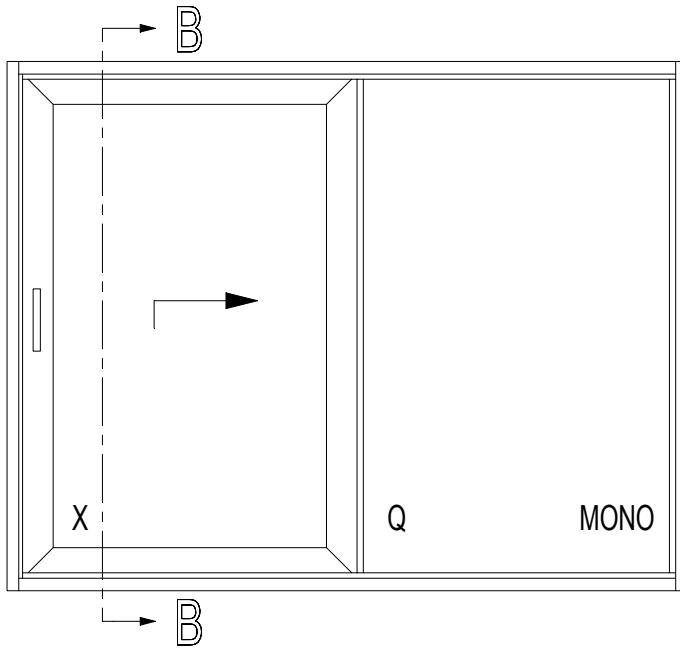

HOOGTE HAUTEUR HEIGHT HOEHE	MIN. 1780 MM
--------------------------------------	--------------

(A) VLEUGELGEWICHT POIDS DU VANTAIL WEIGHT OF THE VENT FLUEGELGEWICHT	MAX. 300KG
--	------------

(B) VLEUGELGEWICHT POIDS DU VANTAIL WEIGHT OF THE VENT FLUEGELGEWICHT	MIN. 300KG MAX. 400KG
--	--------------------------

D0013943

B - B

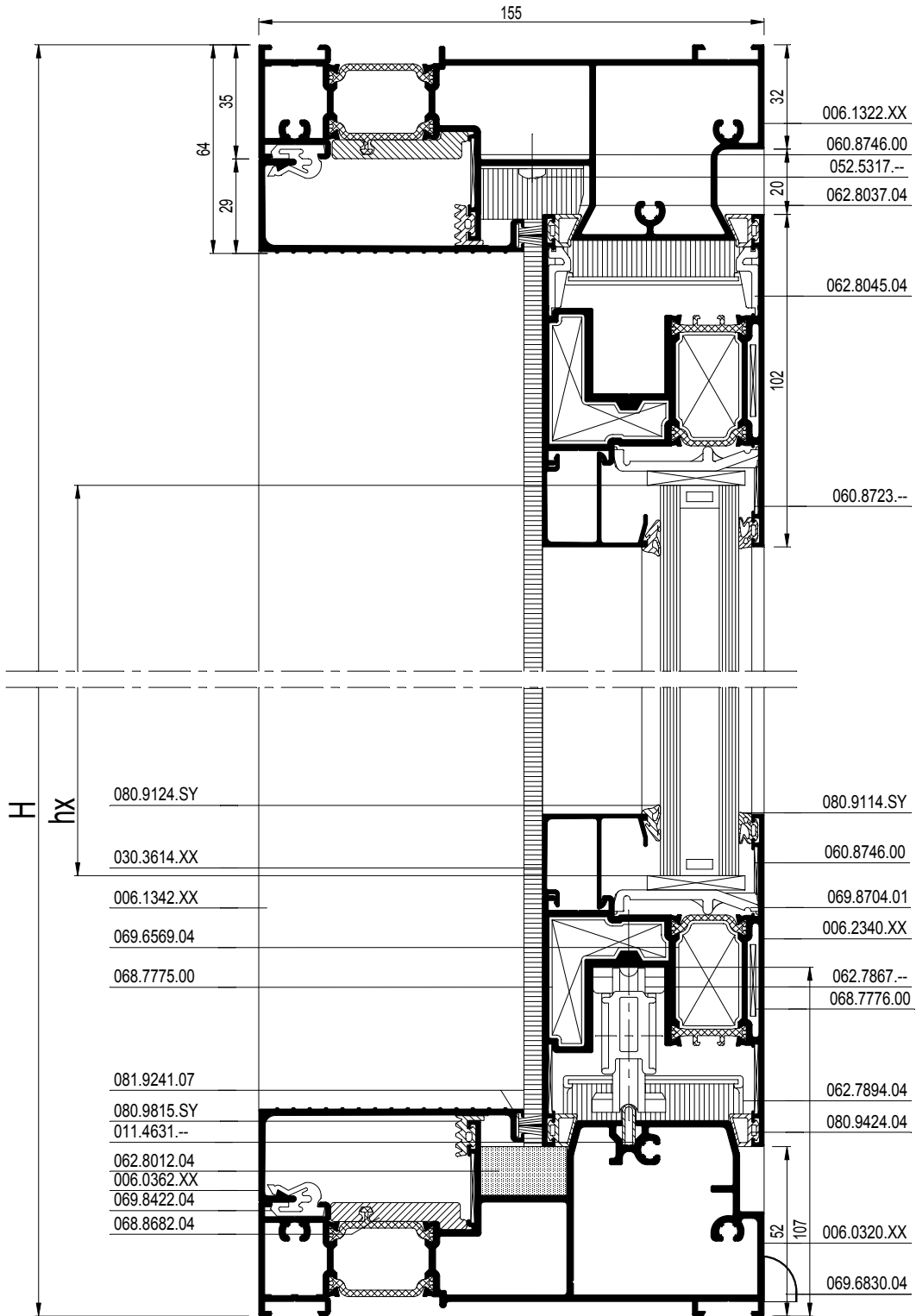

schaal - échelle
 scale - Maßstab
 1/2

D0013943

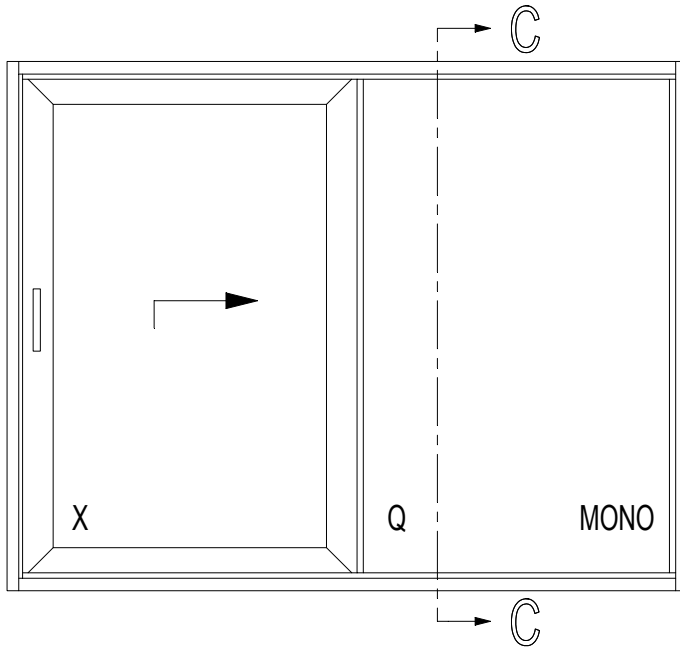

HOOGTE HAUTEUR HEIGHT HOEHE	MIN. 1895 MM
--------------------------------------	--------------

(A)	VLEUGELGEWICHT POIDS DU VANTAIL WEIGHT OF THE VENT FLUEGELGEWICHT	MAX. 300KG
-----	--	------------

(B)	VLEUGELGEWICHT POIDS DU VANTAIL WEIGHT OF THE VENT FLUEGELGEWICHT	MIN. 300KG MAX. 400KG
-----	--	--------------------------

D00090800

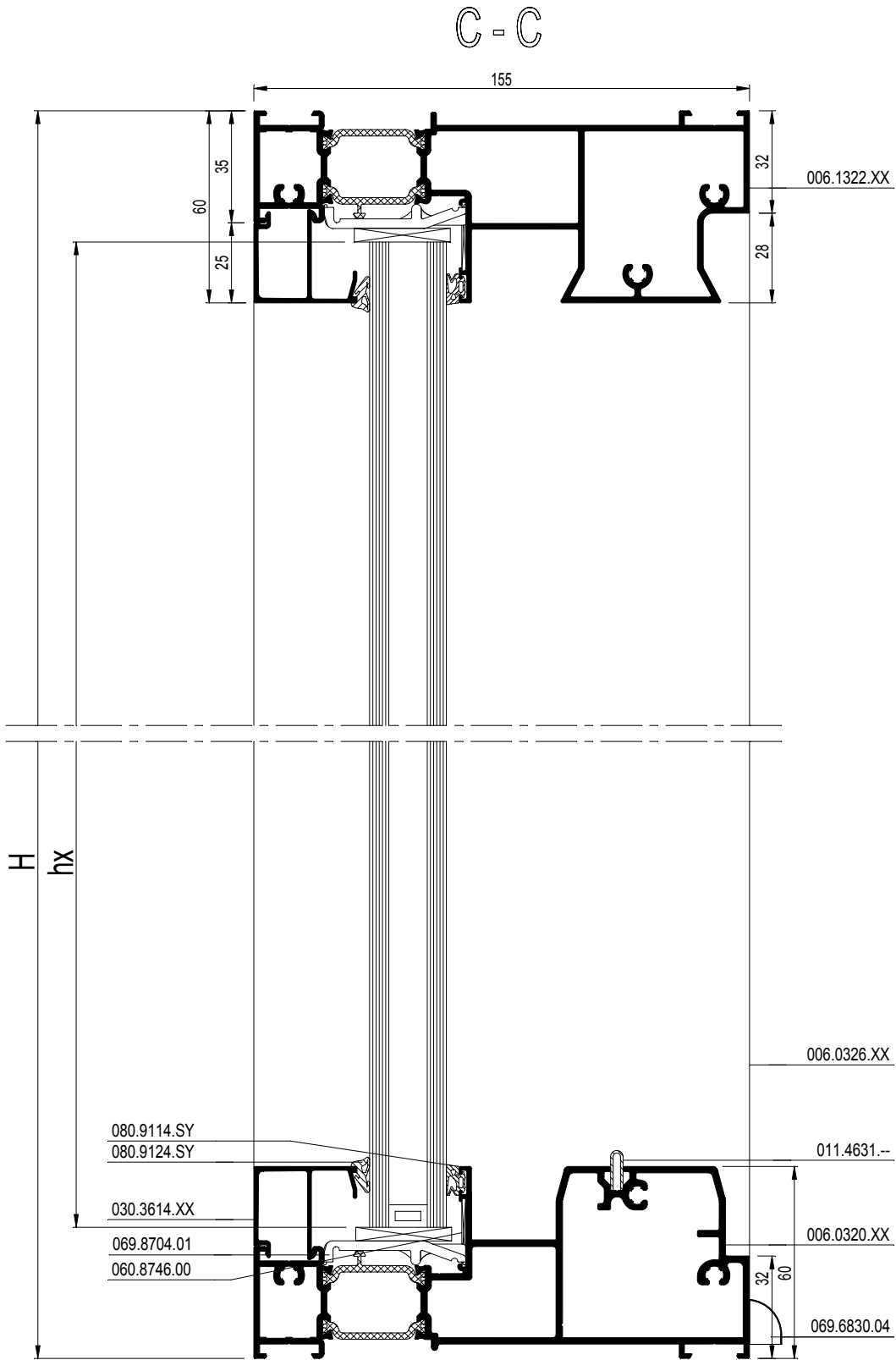

schaal - échelle
 scale - Maßstab
 1/2



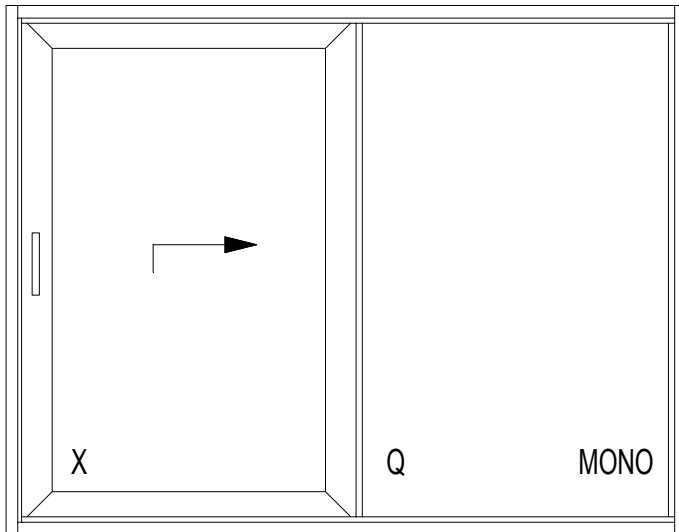



































D0090800



HOOGTE HAUTEUR HEIGHT HOEHE	MIN. 1790 MM
--------------------------------------	--------------

(A) VLEUGELGEWICHT POIDS DU VANTAIL WEIGHT OF THE VENT FLUEGELGEWICHT	MAX. 300KG
--	------------

(B) VLEUGELGEWICHT POIDS DU VANTAIL WEIGHT OF THE VENT FLUEGELGEWICHT	MIN. 300KG MAX. 400KG
--	--------------------------

			#	$\leftarrow L_m \rightarrow$	
006.0320.XX			1	B-70	34.C. ...
006.1322.XX			1	B-70	34.C. ...
006.0324.XX			1	H	34.C. ...
006.0326.XX			1	H	34.C. ...
011.4631.--			1	B-70	34.C. ...
006.0362.XX			2	Bx-92.5	34.C. ...
006.0363.XX			1	H-128	34.C. ...
006.2340.XX			2	Bx-0.5	34.C. ...
			2	H-104	
			1	H-70	
006.1342.XX			1	H-104	34.C. ...
			1	H-70	
006.1341.04			2	H-104	34.C. ...
006.1343.00			1	H-161	34.C. ...
030.3614.XX			2	Bx-154.5	34.C. ...
			2	H-308	
			2	Bq-67.5	
			2	H-120	
(A) 0M0.1505.XX			2	Bx-663.5	34.C. ...
(B) 0M0.1505.XX			2	40	34.C. ...
			1	Bx-1287.5	

bx = Bx-166.5
hx = H-270
bq = Bq-79.5
hq = H-82

			#	
	052.5371.--		12	34.G. ...
	068.8682.04		8	34.G. ...
	068.7775.00		4	34.G. ...
	069.6569.04		4	34.G. ...
	068.7776.00		4	34.G. ...
	060.8723.--		12	34.G. ...
	060.8746.00		4	34.G. ...
	068.8730.00		4	34.G. ...
	068.8682.04		4	34.G. ...
	052.5333.--		2	34.G. ...
	050.5153.--		2	34.G. ...
	062.7894.04		1	34.G. ...
	052.5317.--		2	34.G. ...
	071.6554.SY		2	34.G. ...
	062.8045.04		2	34.G. ...
(*)	062.7902.ZC <small>OF-OIJ-OR-ODER</small>		1	34.G. ...
	062.7868.ZC		1	34.G. ...
	062.7864.PA		1	34.G. ...
	061.7038.--		1	34.G. ...
(A)	062.7715.XX		1	34.G. ...
	050.5051.--		1	34.G. ...
(B)	062.7715.XX		2	34.G. ...
	050.5051.--		2	34.G. ...
	057.5721.--		2	34.G. ...
	062.6744.04		2	34.G. ...
	053.5412.--		2	34.G. ...
(A)	062.7867.--		1	34.G. ...
(B)	062.7867.--		1	34.G. ...
	062.7903.--		1	34.G. ...

			#	
	062.8012.04		1	34.G. ...
	062.8037.04		1	34.G. ...
	052.5317.--		2	34.G. ...
	062.9397.04		2	34.G. ...
	052.5310.--		2xH (3/m)	34.G. ...
	052.5317.--		H (3/m)	34.G. ...
(A)	069.8704.01		16 (-250KG)	34.G. ...
(A)	069.8704.01		12 (+250KG)	34.G. ...
	069.8724.04		4	34.G. ...
(B)	069.8704.01		12	34.G. ...
	069.8724.04		8	34.G. ...
	069.8422.04		2xB (3/m)+H (3/m)	34.G. ...
	069.6830.04		min. 2	34.G. ...
	069.6747.04		2	34.G. ...
	080.9124.SY		(2xB)+(4xH)	34.G. ...
	080.9114.SY		(2xB)+(4xH)	34.G. ...
	080.9381.04		2xH	34.G. ...
	080.9424.04		(2xB)+(2xH)	34.G. ...
	080.9815.SY		B+H	34.G. ...
	081.9241.07		(1xB)+(3xH)	34.G. ...

VARIANT HI

	080.9439.04		(1xBx)+(2xH)	34.G. ...
	080.9625.07		(2xB)+(4xH)	34.G. ...

(*) Afhankelijk van de hoogte
Dépend de l'hauteur
Dependent of the height
Von der Höhe abhängig

D00090570

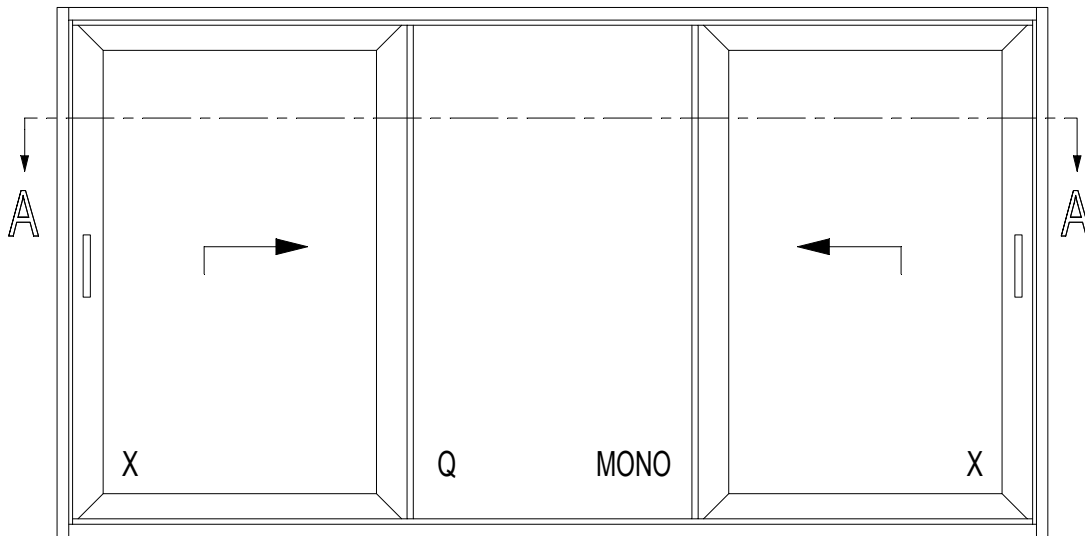

A - A

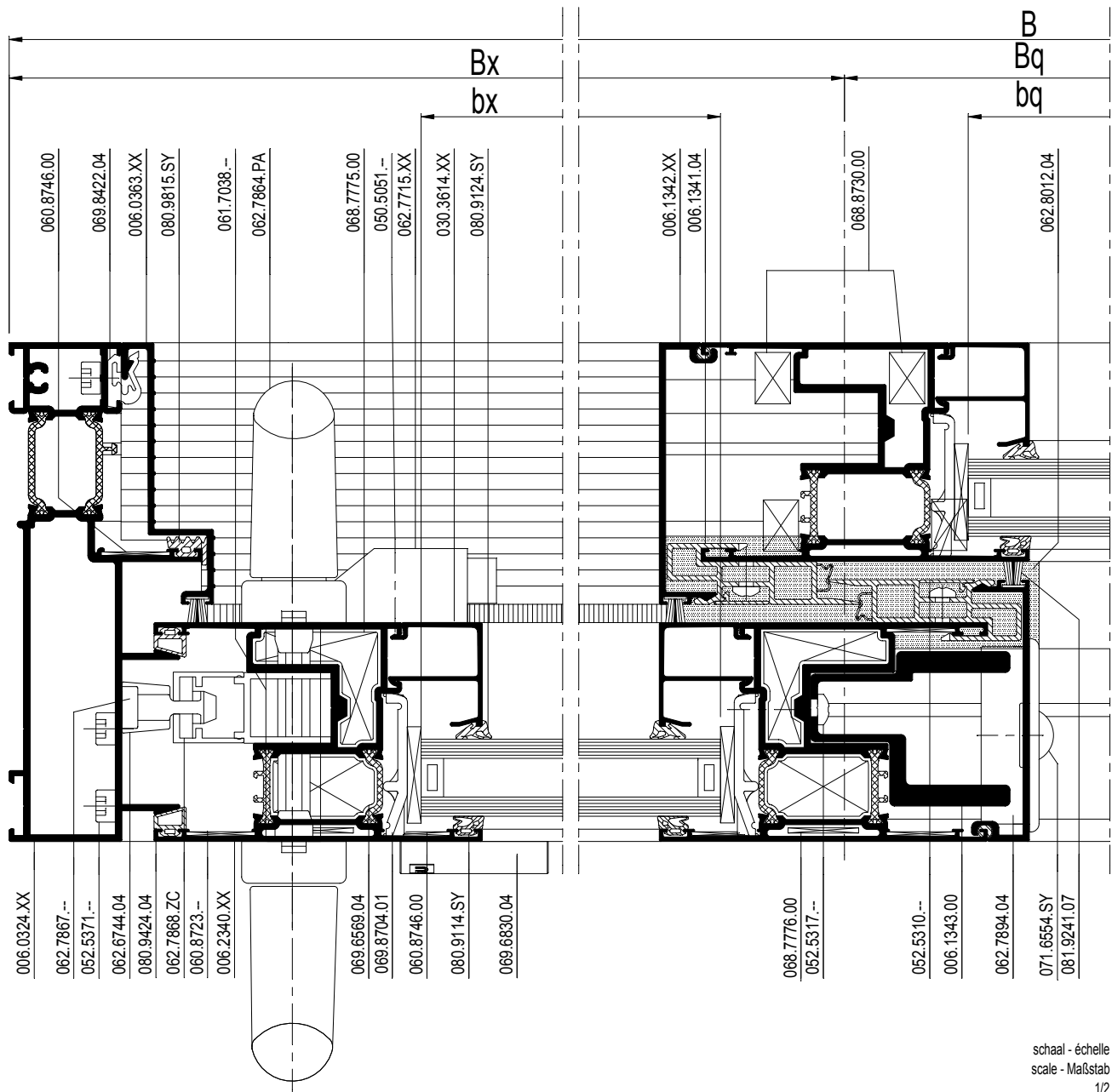

schaal - échelle
 scale - Maßstab
 1/2
 D0013944

HOOGTE HAUTEUR HEIGHT HOEHE	MIN. 1780 MM
--------------------------------------	--------------

(A) VLEUGELGEWICHT POIDS DU VANTAIL WEIGHT OF THE VENT FLUEGELGEWICHT	MAX. 300KG
--	------------

(B) VLEUGELGEWICHT POIDS DU VANTAIL WEIGHT OF THE VENT FLUEGELGEWICHT	MIN. 300KG MAX. 400KG
--	--------------------------

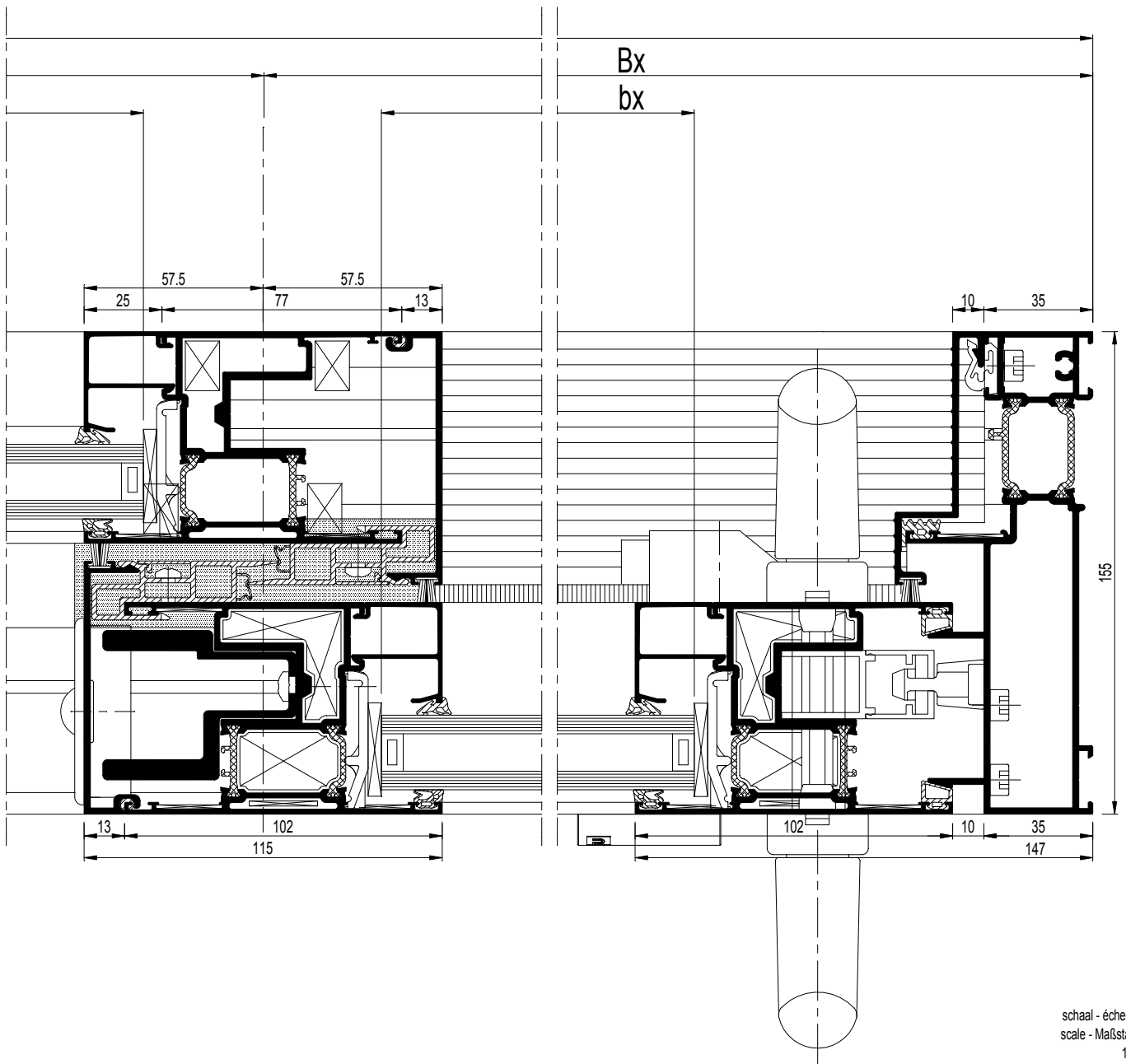

schaal - échelle
 scale - Maßstab
 1/2

D0013944

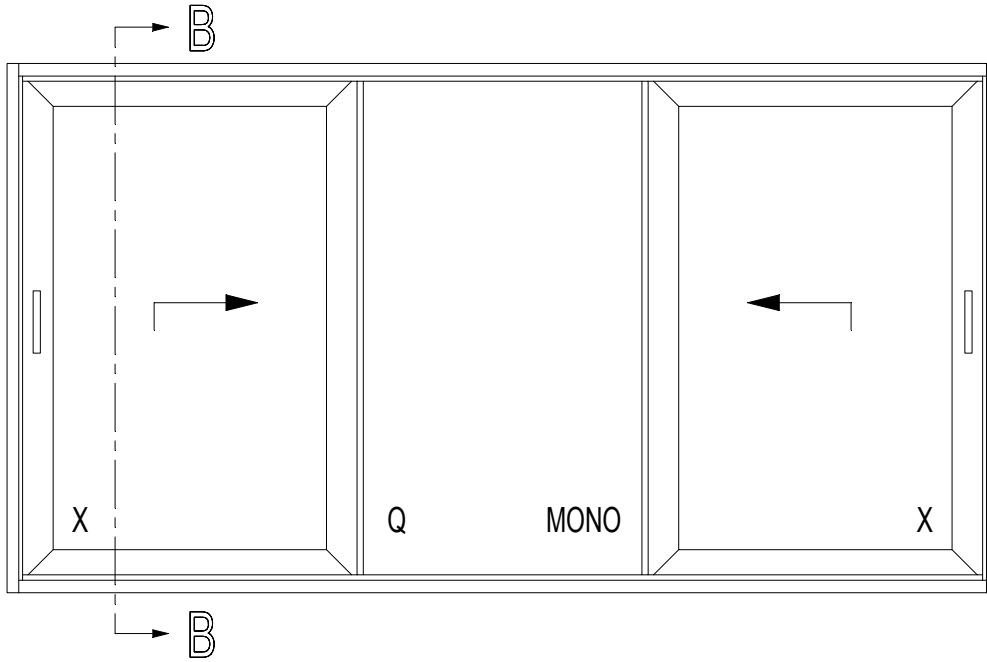

HOOGTE HAUTEUR HEIGHT HOEHE	MIN. 1780 MM
--------------------------------------	--------------

(A) VLEUGELGEWICHT POIDS DU VANTAIL WEIGHT OF THE VENT FLUEGELGEWICHT	MAX. 300KG
--	------------

(B) VLEUGELGEWICHT POIDS DU VANTAIL WEIGHT OF THE VENT FLUEGELGEWICHT	MIN. 300KG MAX. 400KG
--	--------------------------

schaal - échelle
 scale - Maßstab
 1/2
 D0013945



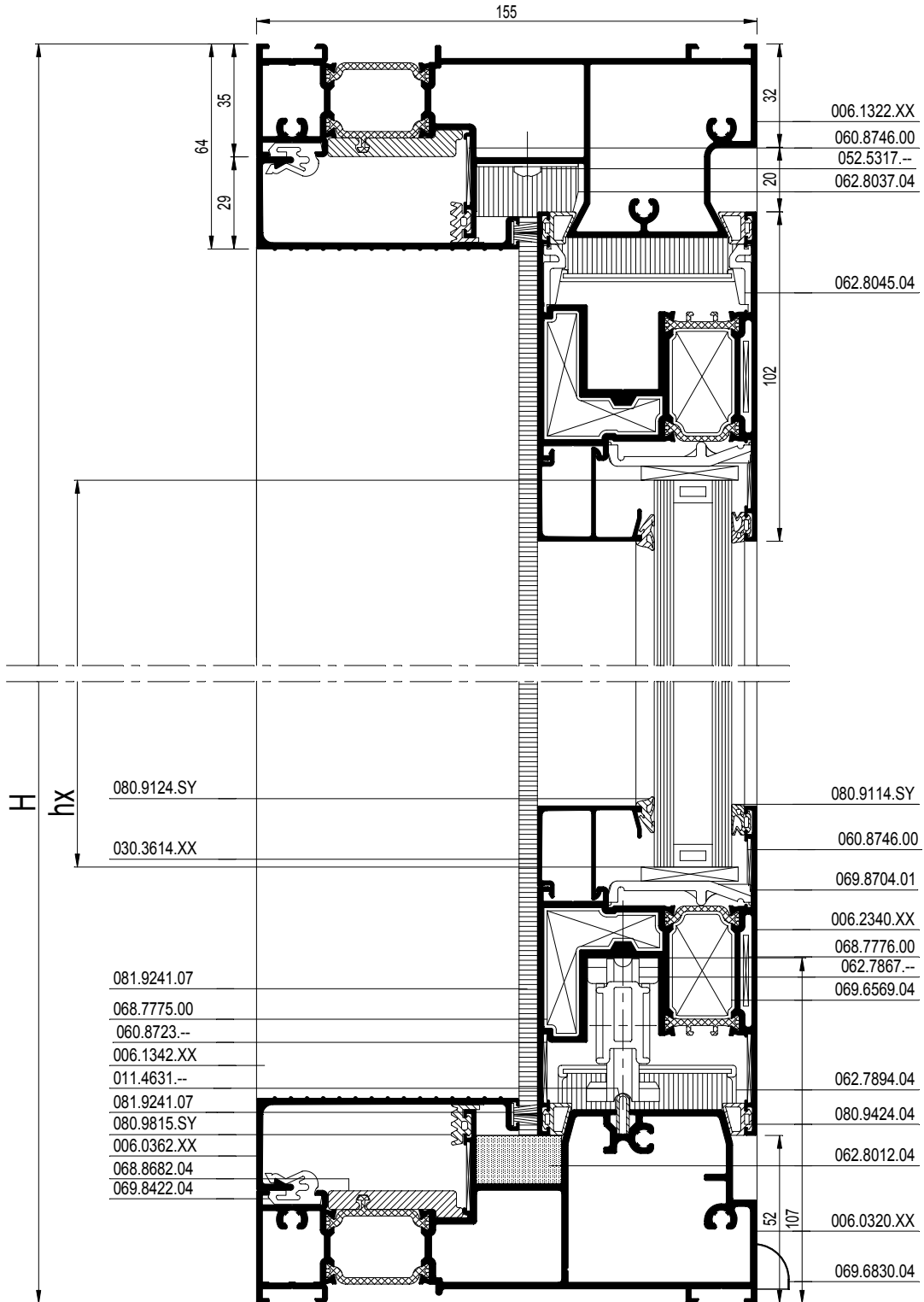





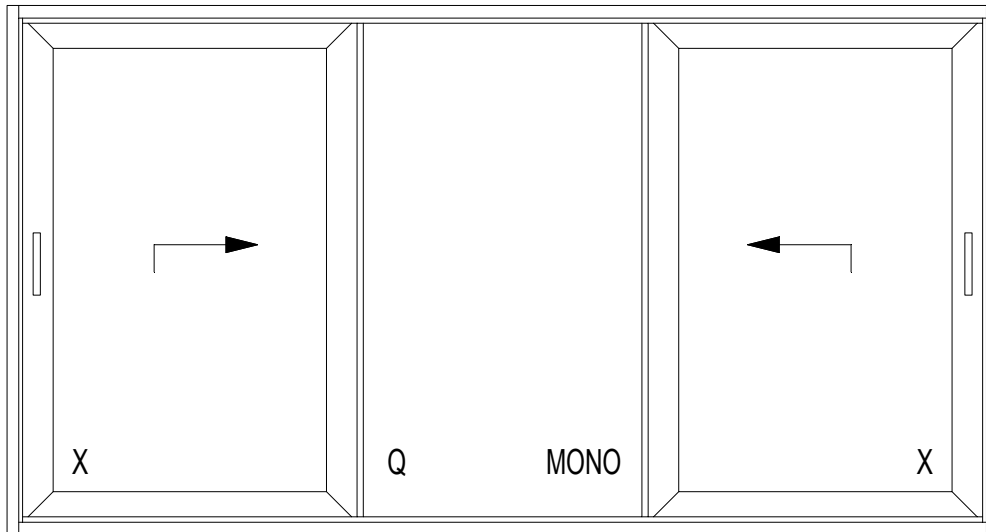





























B - B



schaal - échelle
 scale - Maßstab
 1/2

D0013945



































			#	$\leftarrow L_m \rightarrow$		
006.0320.XX			1	B-70	34.C. ...	bx = Bx-167
006.1322.XX			1	B-70	34.C. ...	hx = H-270
006.0324.XX			2	H	34.C. ...	bq = Bq-77
011.4631.--			1	B-70	34.C. ...	hq = H-82
006.0362.XX			4	Bx-92.5	34.C. ...	
006.0363.XX			2	H-128	34.C. ...	
006.2340.XX			4	Bx-0.5	34.C. ...	
			4	H-104		
			2	H-70		
006.1342.XX			2	H-104	34.C. ...	
			2	H-70		
006.1341.04			4	H-104	34.C. ...	
006.1343.00			2	H-161	34.C. ...	
030.3614.XX			4	Bx-154.5	34.C. ...	
			4	H-308		
			2	Bq-65		
			2	H-120		
(A) 0M0.1505.XX			2	Bx-663.5	34.C. ...	
(B) 0M0.1505.XX			4	40	34.C. ...	
			2	Bx-1287.5		

























HOOGTE HAUTEUR HEIGHT HOEHE	MIN. 1780 MM
--------------------------------------	--------------

(A) VLEUGELGEWICHT POIDS DU VANTAIL WEIGHT OF THE VENT FLUEGELGEWICHT	MAX. 300KG
--	------------



(B) VLEUGELGEWICHT POIDS DU VANTAIL WEIGHT OF THE VENT FLUEGELGEWICHT	MIN. 300KG MAX. 400KG
--	--------------------------

D0045123

			#	
	052.5371.--		12	34.G. ...
	068.8682.04		8	34.G. ...
	068.7775.00		8	34.G. ...
	069.6569.04		8	34.G. ...
	068.7776.00		8	34.G. ...
	060.8723.--		20	34.G. ...
	060.8746.00		8	34.G. ...
	068.8730.00		8	34.G. ...
	068.8682.04		8	34.G. ...
	052.5333.--		4	34.G. ...
	050.5153.--		4	34.G. ...
	062.7894.04		2	34.G. ...
	052.5317.--		4	34.G. ...
	071.6554.SY		4	34.G. ...
	062.8045.04		4	34.G. ...
(*)	062.7902.ZC <small>OF-DU-OR-ORDER</small>		2	34.G. ...
	062.7868.ZC		2	34.G. ...
	062.7864.PA		2	34.G. ...
	061.7038.--		2	34.G. ...
(A)	062.7715.XX		2	34.G. ...
	050.5051.--		2	34.G. ...
(B)	062.7715.XX		4	34.G. ...
	050.5051.--		4	34.G. ...
	057.5721.--		4	34.G. ...
(A)	062.7867.--		2	34.G. ...
	062.7867.--		2	34.G. ...
(B)	062.7903.--		2	34.G. ...
	062.6744.04		4	34.G. ...
	052.5412.--		4	34.G. ...

			#	
	062.8012.04		2	34.G. ...
	062.8037.04		2	34.G. ...
	052.5317.--		4	34.G. ...
	062.9397.04		2	34.G. ...
	052.5310.--		4xH (3/m)	34.G. ...
	052.5317.--		2xH (3/m)	34.G. ...
(A)	069.8704.01		24 (-250KG)	34.G. ...
(A)	069.8704.01		18 (+250KG)	34.G. ...
	069.8724.04		6	34.G. ...
(B)	069.8704.01		18	34.G. ...
	069.8724.04		12	34.G. ...
	069.8422.04		4xBx (3/m)+2xH (3/m)	34.G. ...
	069.8422.04		2xH (3/m)	34.G. ...
	069.6830.04		min. 2	34.G. ...
	069.6747.04		4	34.G. ...
	080.9124.SY		(2xB)+(6xH)	34.G. ...
	080.9114.SY		(2xB)+(6xH)	34.G. ...
	080.9381.04		4xH	34.G. ...
	080.9424.04		(4xB)+(4xH)	34.G. ...
	080.9815.SY		(4xBx)+(2xH)	34.G. ...
	081.9241.07		(4xBx)+(6xH)	34.G. ...

VARIANT HI

080.9439.04		(2xBx)+(4xH)	34.G. ...
080.9625.07		(2xB)+(6xH)	34.G. ...

(*) Afhankelijk van de hoogte
Dépend de l'hauteur
Dependent of the height
Von der Höhe abhängig

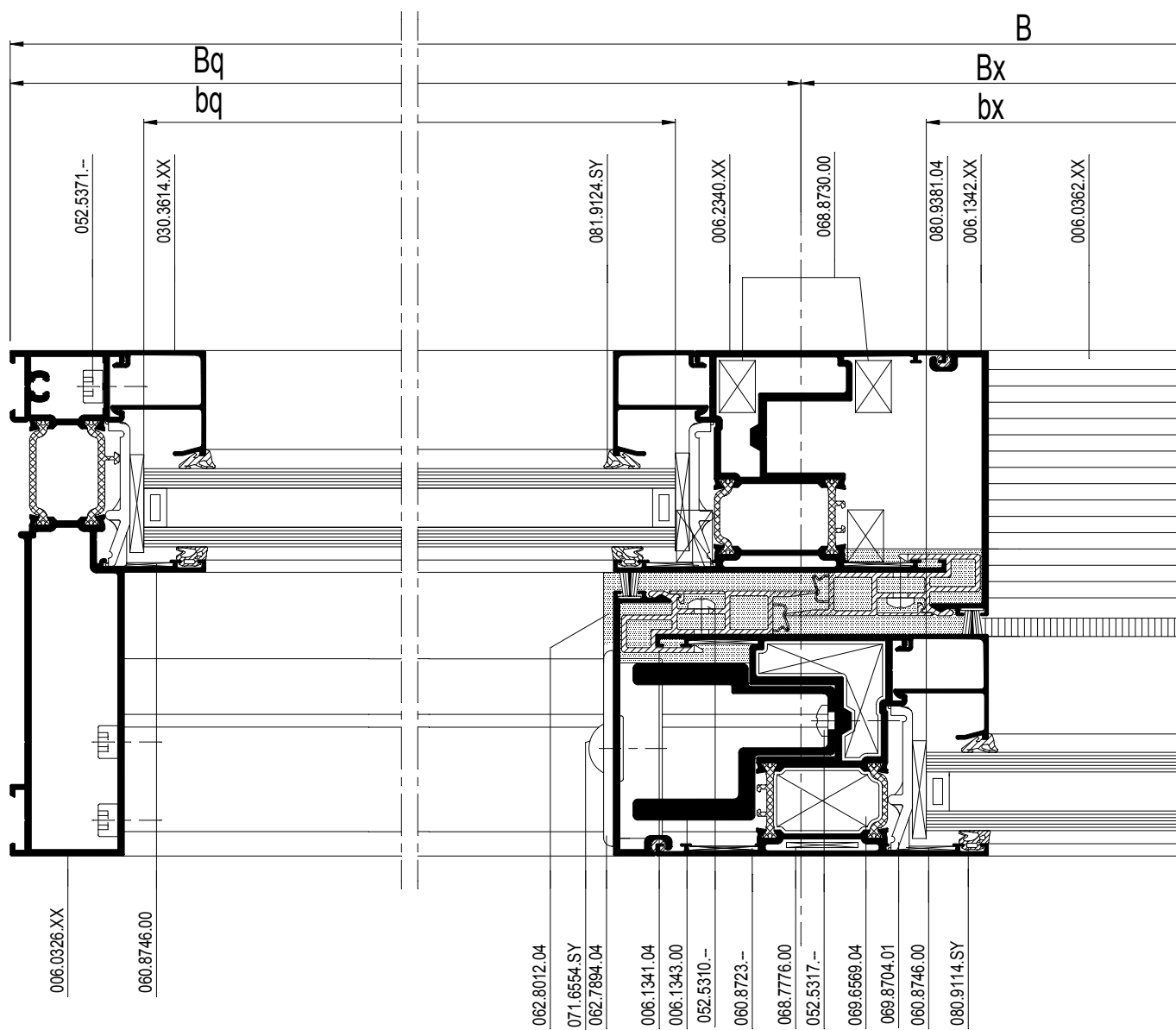
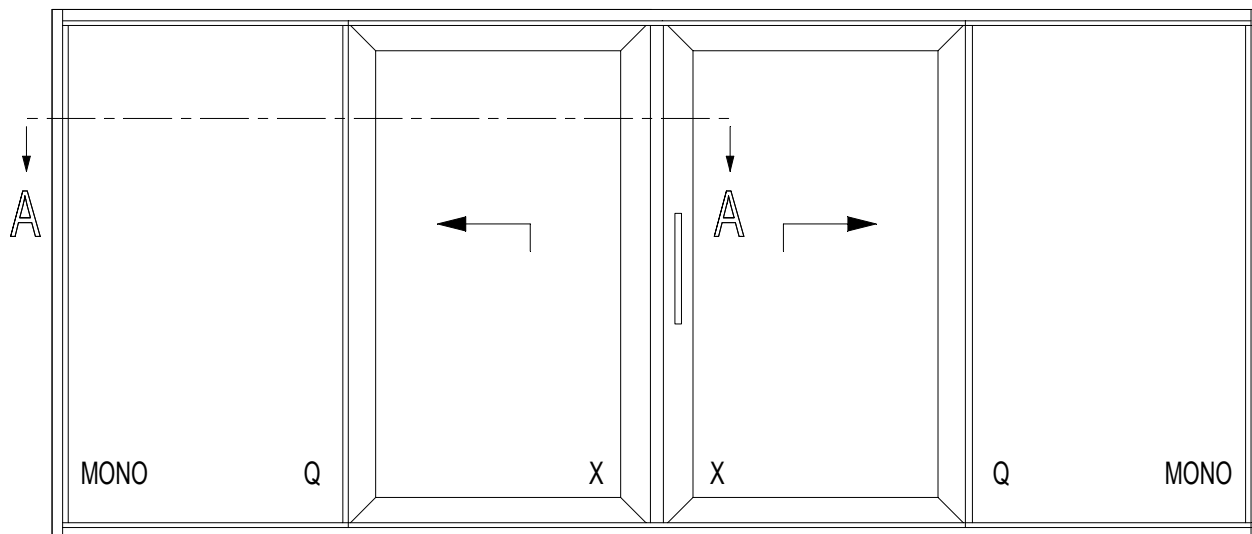

schaal - échelle
 scale - Maßstab
 1/2
 D0013946

HOOGTE HAUTEUR HEIGHT HOEHE	MIN. 1780 MM
--------------------------------------	--------------

(A) VLEUGELGEWICHT POIDS DU VANTAIL WEIGHT OF THE VENT FLUEGELGEWICHT	MAX. 300KG
--	------------

(B) VLEUGELGEWICHT POIDS DU VANTAIL WEIGHT OF THE VENT FLUEGELGEWICHT	MIN. 300KG MAX. 400KG
--	--------------------------

A - A

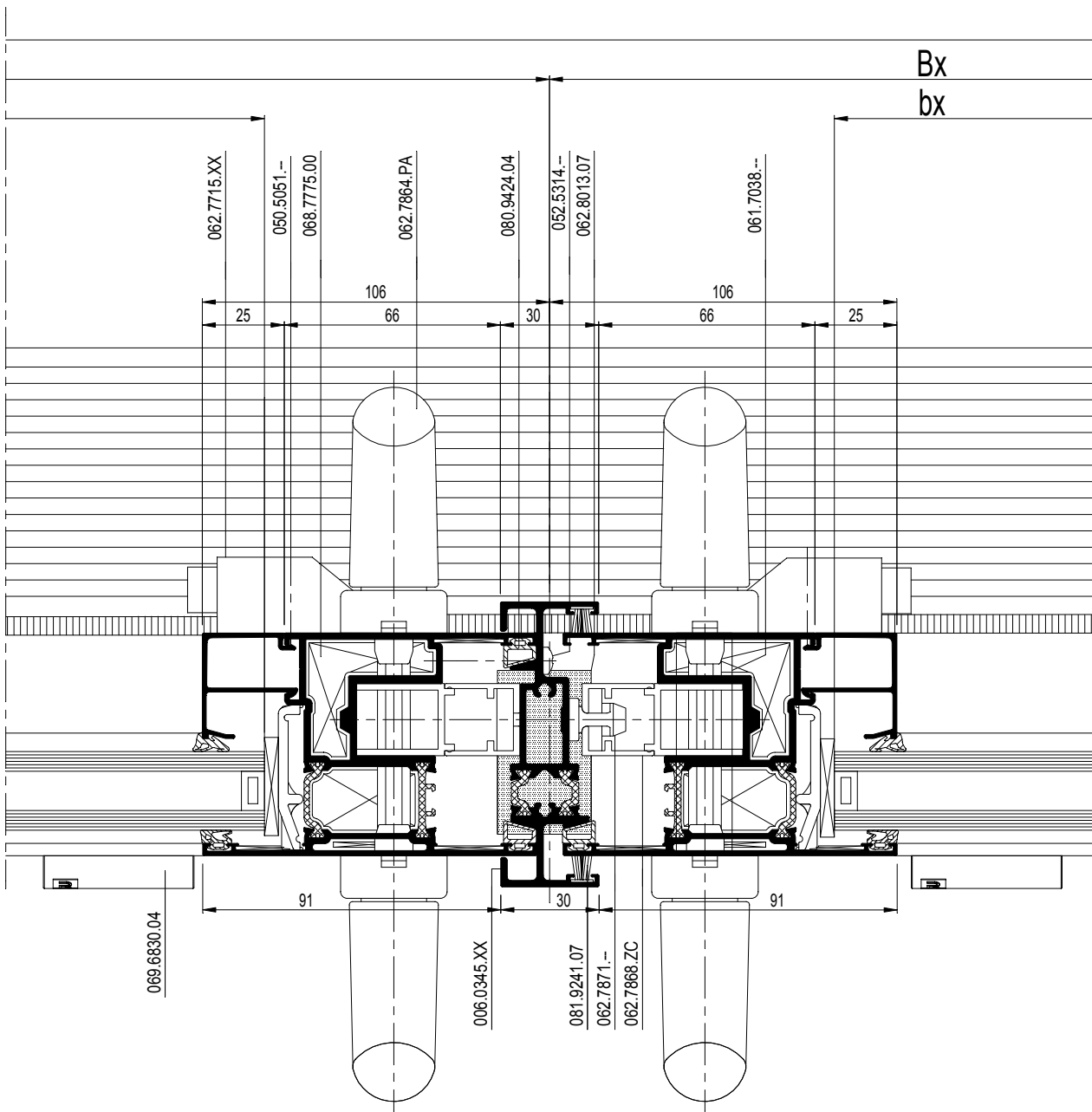





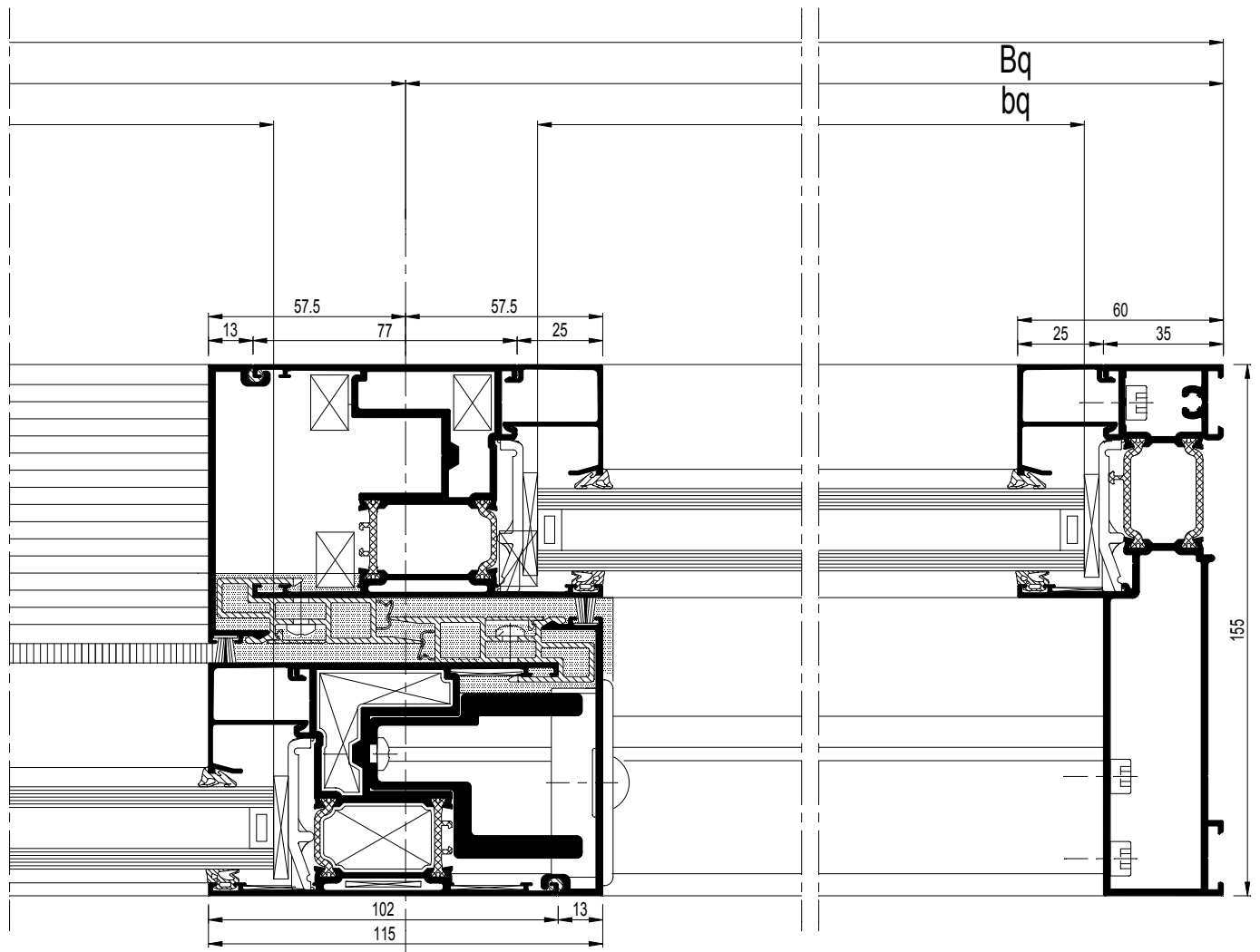
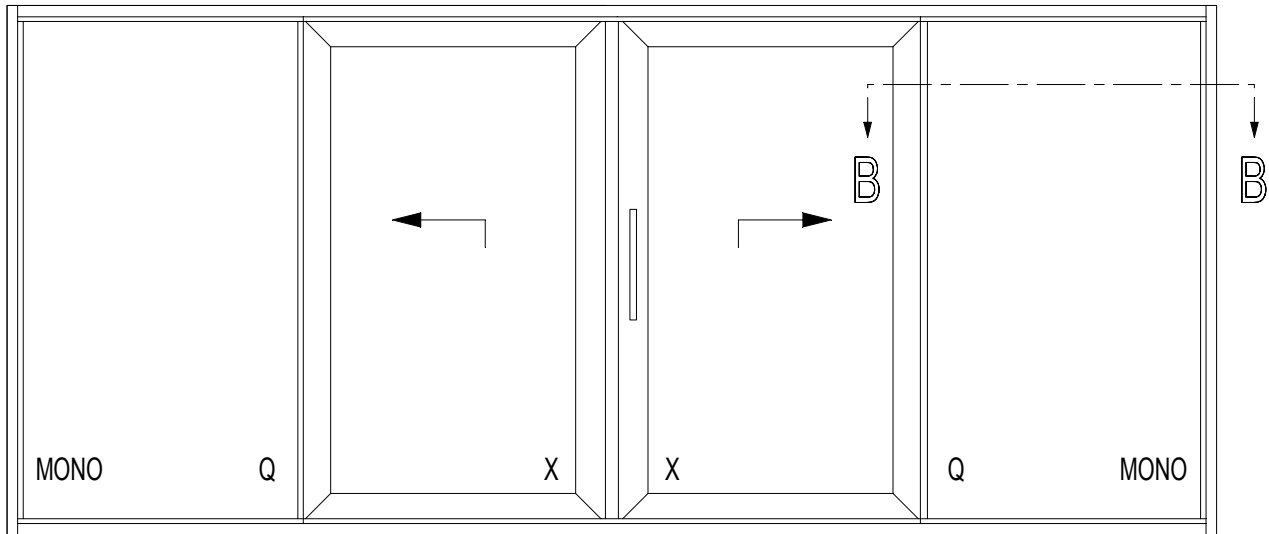



































































































schaal - échelle
 scale - Maßstab
 1/2

D0013946



schaal - échelle
 scale - Maßstab
 1/2
 D0013947

			#	
			12	34.G. ...
			8	34.G. ...
			8	34.G. ...
			8	34.G. ...
			20	34.G. ...
			8	34.G. ...
			8	34.G....
			8	34.G....
			4	34.G....
			4	34.G....
			2	34.G. ...
			4	34.G. ...
			4	34.G. ...
			4	34.G. ...
(*)			2	34.G. ...
			2	34.G. ...
			2	34.G. ...
			2	34.G. ...
(A)			2	34.G. ...
			2	34.G. ...
(B)			4	34.G.
			4	34.G.
(A)			2	34.G. ...
(B)			2	34.G. ...
			2	34.G. ...
			2	34.G. ...

			#	
			2	34.G. ...
			1	34.G. ...
			4	34.G. ...
			2	34.G. ...
			4	34.G. ...
			2	34.G. ...
			4xH (3/m)	34.G. ...
			2xH (3/m)	34.G. ...
			H (3/m)	34.G. ...
(A)			32 (-250KG)	34.G. ...
(A)			24 (+250KG)	34.G. ...
			8	34.G. ...
(B)			4	34.G. ...
			16	34.G. ...
			2xBx (3/m)	34.G. ...
			min. 2	34.G. ...
			4	34.G. ...
			(2xB)+(8xH)	34.G. ...
			(2xB)+(8xH)	34.G. ...
			(4xBx)+(3xH)	34.G. ...
			2xBx	34.G. ...
			4xH	34.G....
			(2xBx)+(6xH)	34.G. ...

VARIANT HI

080.9439.04		(1xBx)+(3xH)	34.G. ...
080.9625.07		(2xB)+(4xH)	34.G. ...

HOOGTE HAUTEUR HEIGHT HOEHE	MIN. 1780 MM
--------------------------------------	--------------

(A) VLEUGELGEWICHT POIDS DU VANTAIL WEIGHT OF THE VENT FLUEGELGEWICHT	MAX. 300KG
--	------------

(B) VLEUGELGEWICHT POIDS DU VANTAIL WEIGHT OF THE VENT FLUEGELGEWICHT	MIN. 300KG MAX. 400KG
--	--------------------------

(*) Afhankelijk van de hoogte
Dépend de l'hauteur
Dependent of the height
Von der Höhe abhängig

D0013947

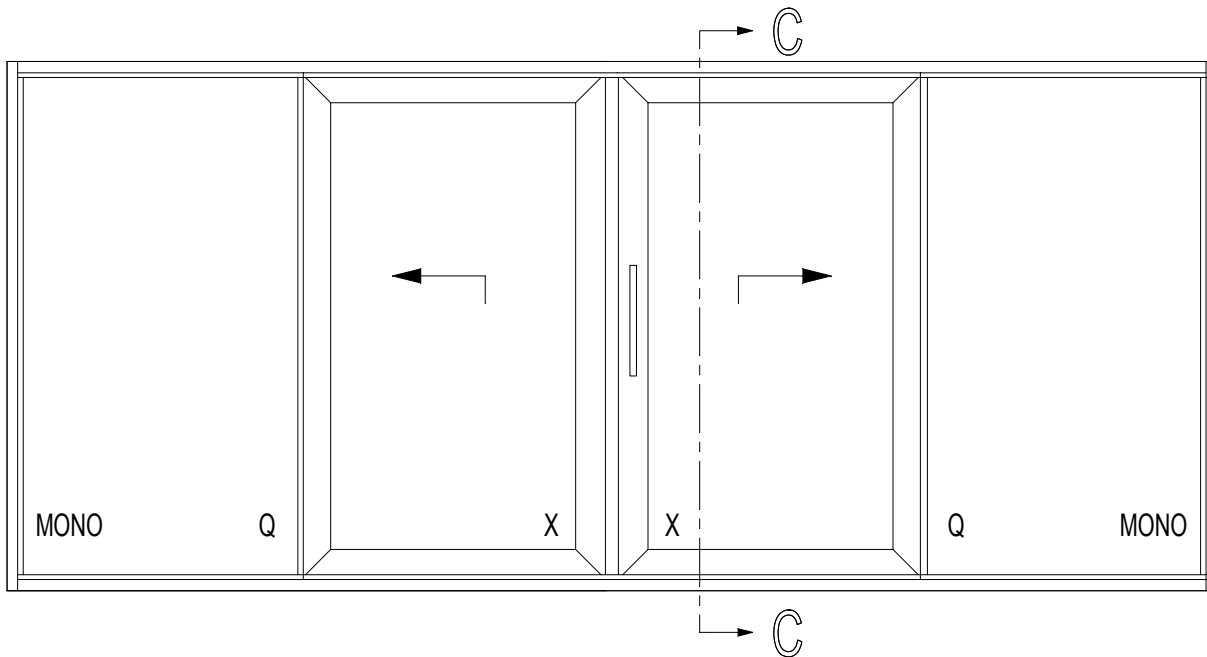

			#	L_m		
006.0320.XX			1	B-70	34.C. ...	$bx = (Bx:2)-125.5$
006.1322.XX			1	B-70	34.C. ...	$hx = H-270$
006.0326.XX			2	H	34.C. ...	$bq = Bq-79.5$
011.4631.--			1	B-70	34.C. ...	$hq = H-82$
006.0362.XX			2	Bx-115	34.C. ...	
006.2340.XX			4	$(Bx:2)+40.5$	34.C. ...	
			4	H-104		
			2	H-70		
006.1342.XX			2	H-104	34.C. ...	
			2	H-70		
006.1341.04			4	H-104	34.C. ...	
006.1343.00			2	H-161	34.C. ...	
006.0345.XX			1	H-104	34.C. ...	
030.3614.XX			4	$(Bx:2)-113.5$	34.C. ...	
			4	H-308		
			2	$Bq-67.5$		
			2	H-120		
(A) 0M0.1505.XX			2	$(Bx:2)-622.5$	34.C. ...	
(B) 0M0.1505.XX			4	40	34.C. ...	
			2	$(Bx:2)-1246.5$		

HOOGTE HAUTEUR HEIGHT HOEHE	MIN. 1780MM
--------------------------------------	-------------

(A) VLEUGELGEWICHT POIDS DU VANTAIL WEIGHT OF THE VENT FLUEGELGEWICHT	MAX. 300KG
--	------------

(B) VLEUGELGEWICHT POIDS DU VANTAIL WEIGHT OF THE VENT FLUEGELGEWICHT	MIN. 300KG MAX. 400KG
--	--------------------------

C - C

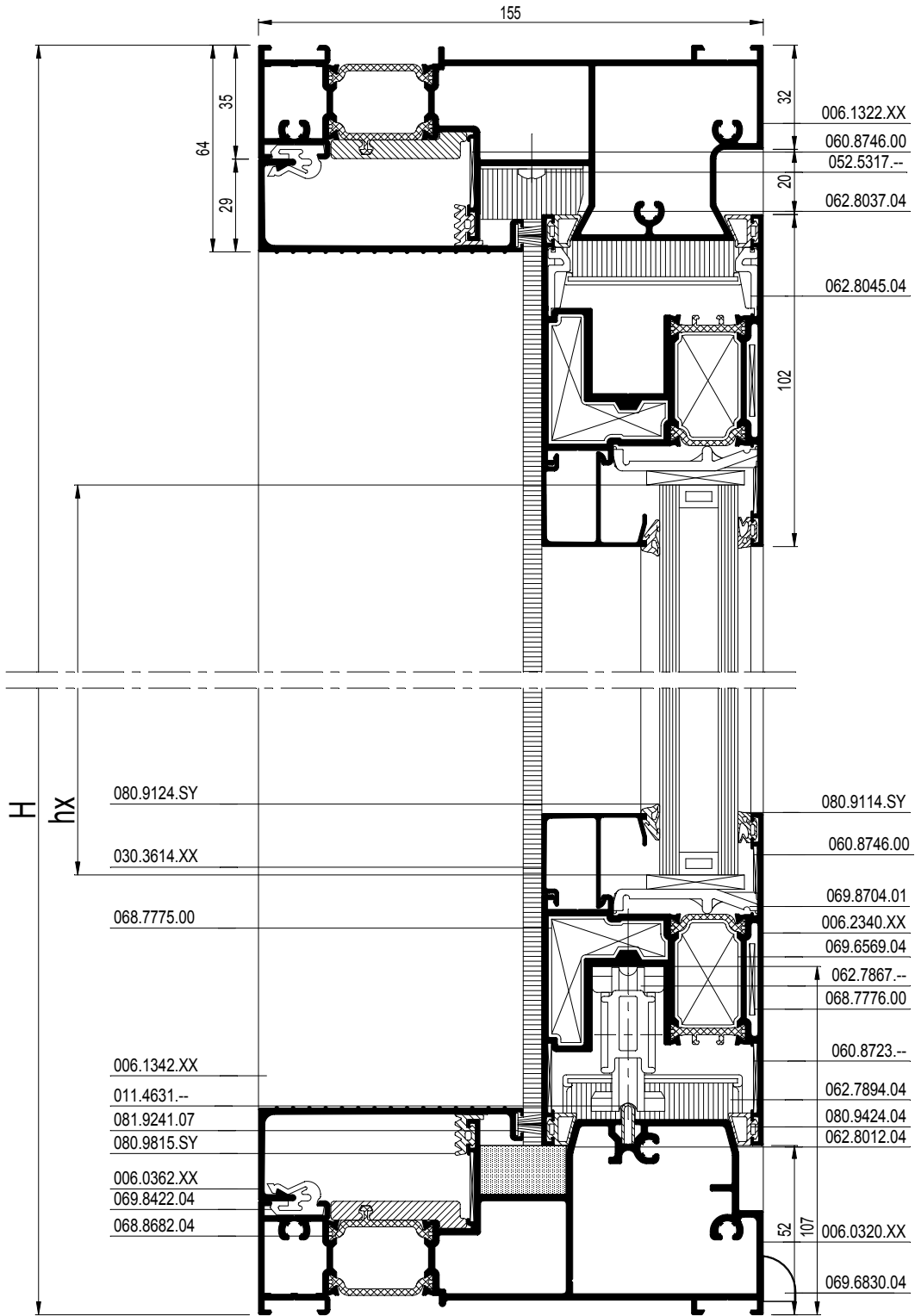

schaal - échelle
 scale - Maßstab
 1/2

D0013948

(A)	VLEUGELGEWICHT POIDS DU VANTAIL WEIGHT OF THE VENT FLUEGELGEWICHT	MAX. 300KG
-----	--	------------

(B)	VLEUGELGEWICHT POIDS DU VANTAIL WEIGHT OF THE VENT FLUEGELGEWICHT	MIN. 300KG MAX. 400KG
-----	--	--------------------------

	HOOGTE HAUTEUR HEIGHT HOEHE	MIN. 1780 MM
--	--------------------------------------	--------------

A - A

B
Bx2



schaal - échelle
 scale - Maßstab
 1/2
 D0084696

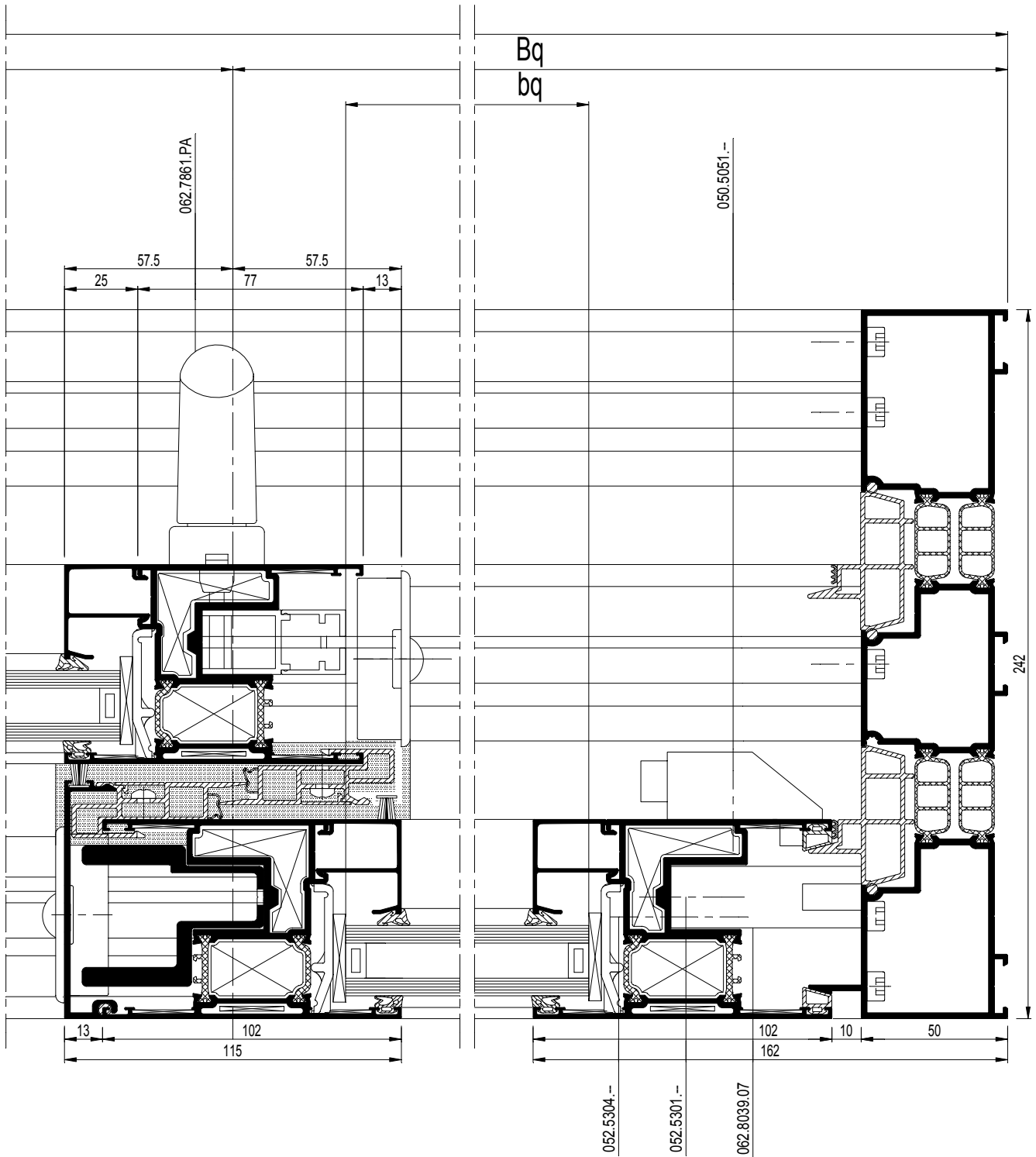

schaal - échelle
 scale - Maßstab
 1/2

D0084696

CP 155-LS

3-RAIL XXQ
 3-RAIL XXQ
 3-RAIL XXQ
 3-RAIL XXQ

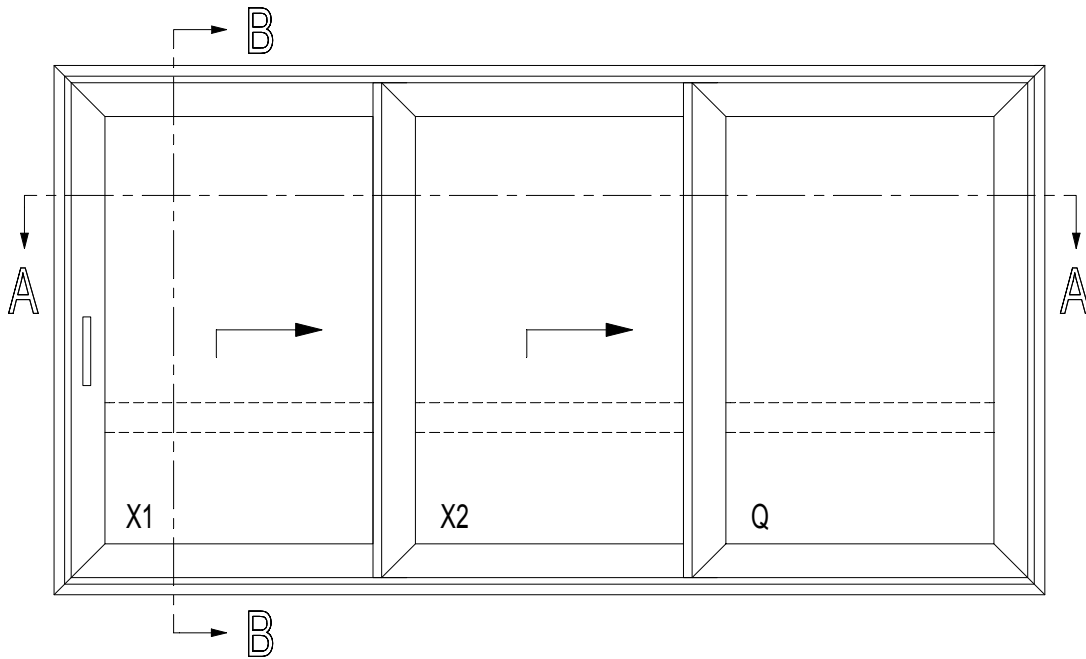

HOOGTE HAUTEUR HEIGHT HOEHE	MIN. 1780 MM
--------------------------------------	--------------

(A) VLEUGELGEWICHT POIDS DU VANTAIL WEIGHT OF THE VENT FLUEGELGEWICHT	MAX. 300KG
--	------------

(B) VLEUGELGEWICHT POIDS DU VANTAIL WEIGHT OF THE VENT FLUEGELGEWICHT	MIN. 300KG MAX. 400KG
--	--------------------------

D0084697

B - B

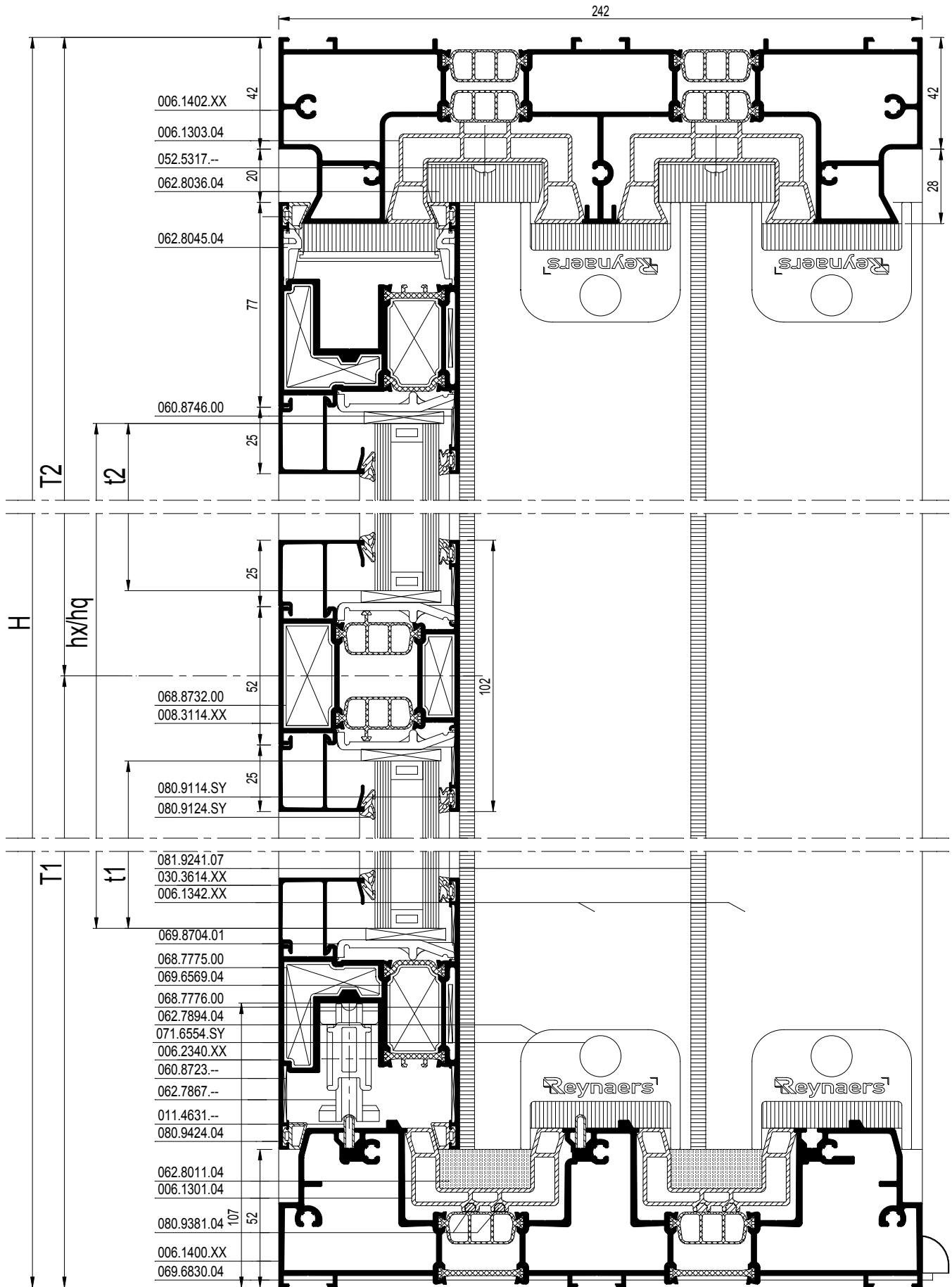

D0084697

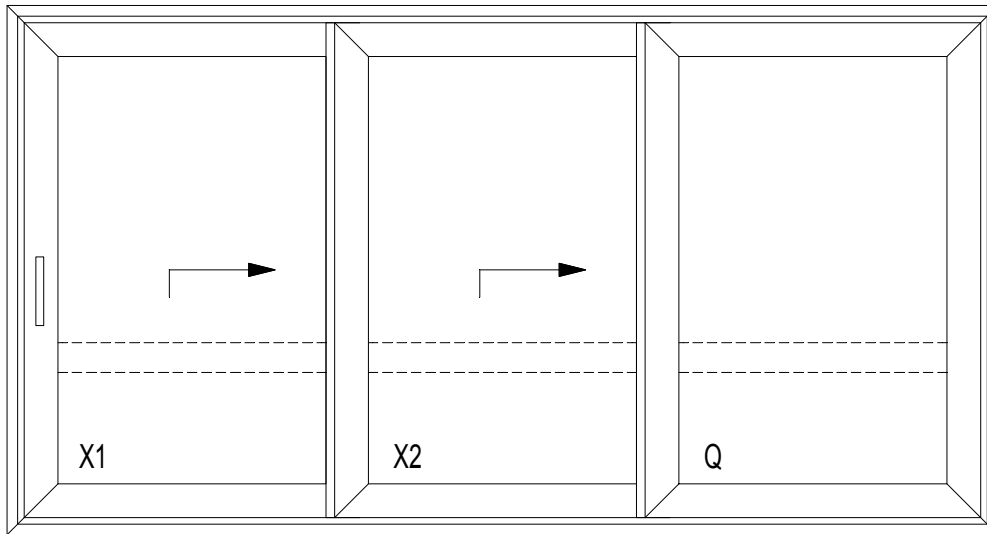

bx1 = Bx1-181.5
hx/hq= H-280
bx2 = Bx2-77
bq= Bq-181.5

met dwarsstijl
avec traverse
with transom
mit Sprossenprofil

t1= T1-167
t2 = T2-177

			#	
	052.5371.--		20	34.G. ...
	062.9399.04		2	34.G. ...
	068.7775.00		12	34.G. ...
	069.6569.04		12	34.G. ...
	068.7776.00		12	34.G. ...
	060.8723.--		24	34.G. ...
	060.8746.00		12	34.G. ...
	062.7894.04		4	34.G. ...
	052.5317.--		8	34.G. ...
	071.6554.SY		8	34.G. ...
(A)	062.7867.--		2	34.G. ...
(B)	062.7867.--		2	34.G. ...
	062.7903.--		2	34.G. ...
	062.8038.07		3	34.G. ...
	052.5301.--		3	34.G. ...
	052.5304.--		3	34.G. ...
	062.8039.07		3	34.G. ...
	052.5301.--		3	34.G. ...
	052.5304.--		3	34.G. ...
(*)	062.7902.ZC		2	34.G. ...
	062.7868.ZC		2	34.G. ...
	062.7864.PA		1	34.G. ...
	062.7861.PA		1	34.G. ...
	061.7038.--		1	34.G. ...
(A)	062.7715.XX		2	34.G. ...
	050.5051.--		2	34.G. ...
(B)	062.7715.XX		4	34.G.
	050.5051.--		4	34.G.
	057.5721.--		4	34.G.

			#	
	062.6744.04		2	34.G. ...
	053.5412.--		2	34.G. ...
	062.8045.04		2	34.G. ...
	062.8011.04		2	34.G. ...
	062.8036.04		2	34.G. ...
	052.5317.--		4	34.G. ...
	052.5310.--		4xH (3/m)	34.G. ...
	052.5317.--		2xH (3/m)	34.G. ...
(**)	062.9372.04		4	34.G.
	062.9375.04		4	34.G.
(A)	069.8704.01		24-(250kg)	34.G. ...
(A)	069.8704.01		18(+250kg)	34.G.
	069.8724.04		6	34.G.
(B)	069.8704.01		18	34.G. ...
	069.8724.04		12	34.G. ...
	062.6857.04		1	34.G.
	069.6830.04		min. 2	34.G. ...
	080.9124.SY		(2xB)+(6xH)	34.G. ...
	080.9114.SY		(2xB)+(6xH)	34.G. ...
	080.9381.04		(4xB)+(12xH)	34.G. ...
	080.9424.04		4xH	34.G. ...
	081.9241.07		(4xH)	34.G. ...

	068.8732.00		6	34.G. ...
	069.8704.01		12	34.G. ...
	080.9124.SY		2xB	34.G. ...
	080.9114.SY		2xB	34.G. ...

met dwarsstijl
avec traverse
with transom
mit Sprossenprofil
+

VARIANT HI

	080.9439.04		(1xB)+(4xH)	34.G. ...
	080.9625.07		(2xB)+(6xH)	34.G. ...









































HOOGTE HAUTEUR HEIGHT HOEHE	MIN. 1895 MM
--------------------------------------	--------------

(A)



VLEUGELGEWICHT POIDS DU VANTAIL WEIGHT OF THE VENT FLUEGELGEWICHT	MAX. 300KG
--	------------

(B)

VLEUGELGEWICHT POIDS DU VANTAIL WEIGHT OF THE VENT FLUEGELGEWICHT	MIN. 300KG MAX. 400KG
--	--------------------------

				#	L_m	
006.1400.XX 006.1301.04				1	B-100	34.C. ...
				2		
006.1402.XX 006.1303.04				1	B-100	34.C. ...
				2		
006.1406.XX				2	H	34.C. ...
006.0305.XX				4	H - 150	34.C. ...
011.4631.--				2	B-100	34.C. ...
006.2340.XX				2	Bx1-15.5	34.C. ...
				2	Bx2+89	
				2	Bq-15.5	
				6	H-114	
006.1342.XX				4	H-114	34.C. ...
006.1341.04				4	H-114	34.C. ...
006.1343.00				2	H-172	34.C. ...
030.3614.XX				2	Bx1-169.5	34.C. ...
				2	Bx2-65	
				2	Bq-169.5	
				6	H-318	
(A) 0M0.1505.XX				1	Bx1-678.5	34.C. ...
				1	Bx2-574	
				1	Bq-678.5	
(B) 0M0.1505.XX				6	40	34.C. ...
				1	Bx1-1302.5	
				1	Bx2-1198	
				1	Bq-1302.5	

met dwarsstijl
avec traverse
with transom
mit Sprossenprofil
+

008.3114.XX				1	Bx1-169.5	34.C. ...
				1	Bx2-65	
				1	Bq-169.5	

(*) Afhankelijk van de hoogte
Dépend de l'hauteur
Dependent of the height
Von der Höhe abhängig

(**) Afhankelijk van de positie van de primaire vleugel
Dépend de la position de ouvrante principale
depending on the position of the primary vent
abhängig von der Position des primären Fluegel

(A)	VLEUGELGEWICHT POIDS DU VANTAIL WEIGHT OF THE VENT FLUEGELGEWICHT	MAX. 300KG
-----	--	------------

(B)	VLEUGELGEWICHT POIDS DU VANTAIL WEIGHT OF THE VENT FLUEGELGEWICHT	MIN. 300KG MAX. 400KG
-----	--	--------------------------

	HOOGTE HAUTEUR HEIGHT HOEHE	MIN. 1780 MM
--	--------------------------------------	--------------

A - A

B
Bx2

Bx1
bx1



schaal - échelle
 scale - Maßstab
 1/2
 D0044654

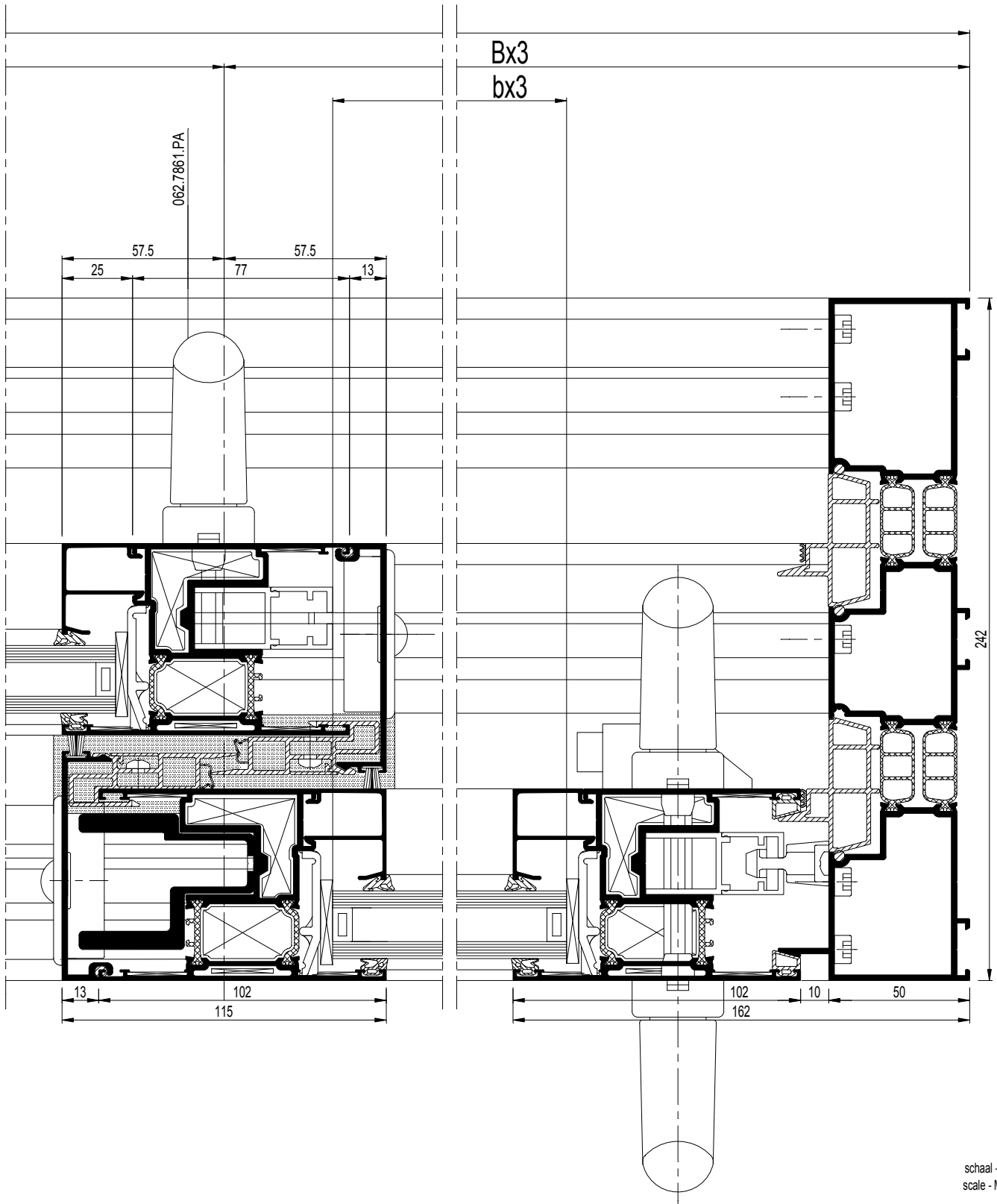

schaal - échelle
 scale - Maßstab
 1/2

D0044654

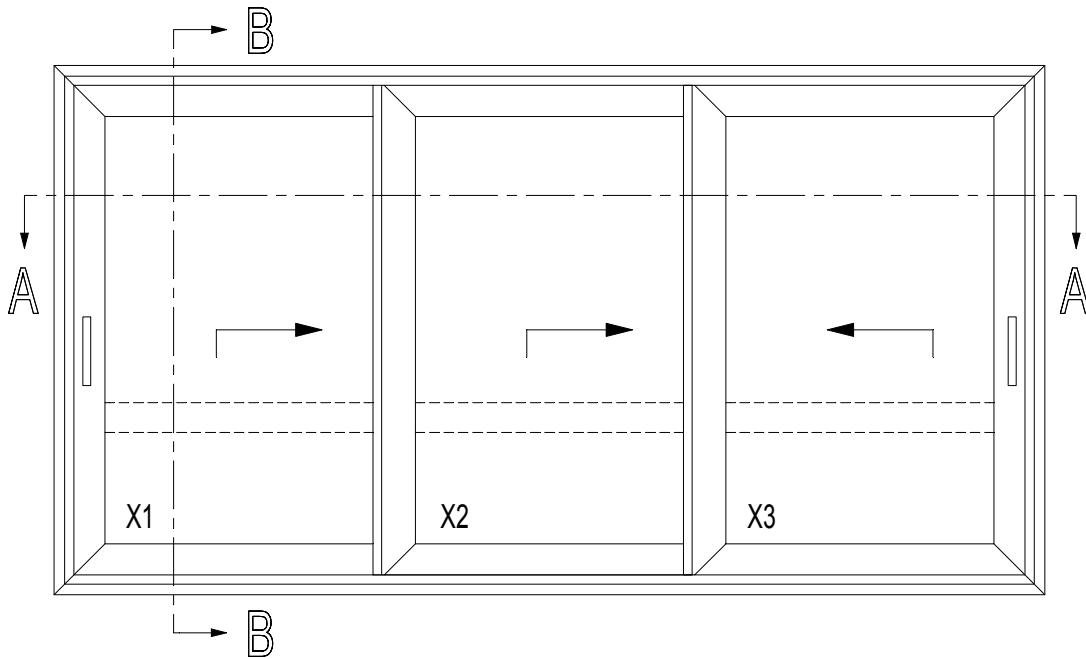

HOOGTE HAUTEUR HEIGHT HOEHE	MIN. 1780 MM
--------------------------------------	--------------

(A) VLEUGELGEWICHT POIDS DU VANTAIL WEIGHT OF THE VENT FLUEGELGEWICHT	MAX. 300KG
--	------------

(B) VLEUGELGEWICHT POIDS DU VANTAIL WEIGHT OF THE VENT FLUEGELGEWICHT	MIN. 300KG MAX. 400KG
--	--------------------------

D0044639

B - B

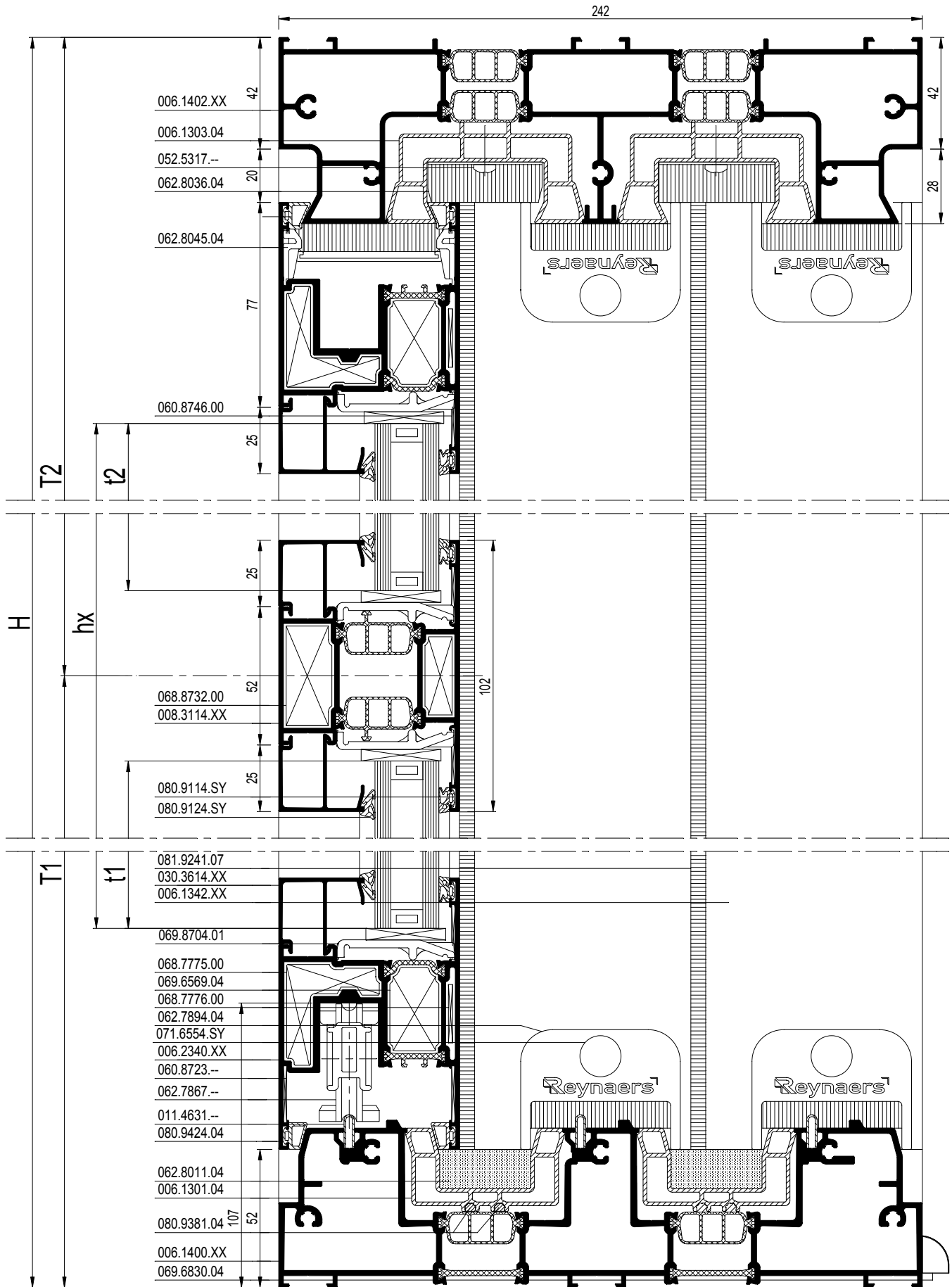

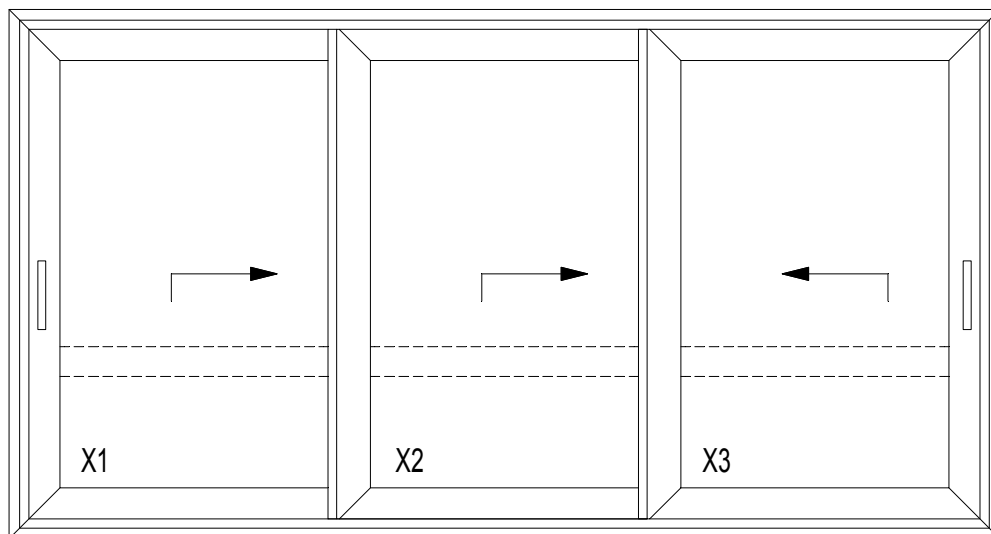

bx1 = Bx1-181.5

hx = H-280

bx2 = Bx2-77

bx3 = Bx3-181.5

met dwarsstijl
avec traverse
with transom
mit Sprossenprofil

t1 = T1-167

t2 = T2-177

			#	
	052.5371.--		20	34.G. ...
	068.7775.00		12	34.G. ...
	069.6569.04		12	34.G. ...
	068.7776.00		12	34.G. ...
	060.8723.--		24	34.G. ...
	060.8746.00		12	34.G. ...
	062.7894.04		4	34.G. ...
	052.5317.--		8	34.G. ...
	071.6554.SY		8	34.G. ...
	062.8045.04		4	34.G. ...
(*)	062.7902.ZC		3	34.G. ...
	062.7868.ZC		3	34.G. ...
	062.7864.PA		2	34.G. ...
	062.7861.PA		1	34.G. ...
	061.7038.--		2	34.G. ...
(A)	062.7715.XX		2	34.G. ...
	050.5051.--		2	34.G. ...
(B)	062.7715.XX		4	34.G. ...
	057.5721.--		4	34.G. ...
	050.5052.--		4	34.G. ...
(A)	062.7867.--		3	34.G. ...
(B)	062.7867.--		3	34.G. ...
	062.7903.--		3	34.G. ...
	062.6744.04		4	34.G. ...
	053.5412.--		4	34.G. ...
	062.8011.04		2	34.G. ...
	062.8036.04		2	34.G. ...
	052.5317.--		4	34.G. ...

			#	
	052.5310.--		4xH (3/m)	34.G. ...
	052.5317.--		2xH (3/m)	34.G. ...
(**)	062.9372.04		4	34.G. ...
	062.9375.04		4	34.G. ...
	062.9399.04		2	34.G. ...
(A)	069.8704.01		24(-250kg)	34.G. ...
(A)	069.8704.01		18(+250kg)	34.G. ...
	069.8724.04		6	34.G. ...
(B)	069.8704.01		18	34.G. ...
	069.8724.04		12	34.G. ...
	062.6857.04		1	34.G. ...
	069.6830.04		min. 2	34.G. ...
	080.9124.SY		(2xB)+(6xH)	34.G. ...
	080.9114.SY		(2xB)+(6xH)	34.G. ...
	080.9381.04		(4xB)+(12xH)	34.G. ...
	080.9424.04		4xH	34.G. ...
	081.9241.07		(4xH)	34.G. ...

	068.8732.00		6	34.G. ...
	069.8704.01		12	34.G. ...
	080.9124.SY		2xB	34.G. ...
	080.9114.SY		2xB	34.G. ...

met dwarsstijl
avec traverse
with transom
mit Sprossenprofil
+









































VARIANT HI

	080.9439.04		(1xB)+(4xH)	34.G. ...
	080.9625.07		(2xB)+(6xH)	34.G. ...



(*) Afhankelijk van de hoogte
Dépend de l'hauteur
Dependent of the height
Von der Höhe abhängig

(**) Afhankelijk van de positie van de primaire vleugel
Dépend de la position de l'ouvrante principale
depending on the position of the primary vent
abhängig von der Position des primären Fluegel

	HOOGTE HAUTEUR HEIGHT HOEHE	MIN. 1780 MM
(A)	VLEUGELGEWICHT POIDS DU VANTAIL WEIGHT OF THE VENT FLUEGELGEWICHT	MAX. 300KG
(B)	VLEUGELGEWICHT POIDS DU VANTAIL WEIGHT OF THE VENT FLUEGELGEWICHT	MIN. 300KG MAX. 400KG

				#	L_m	
006.1400.XX 006.1301.04				1	B-100	34.C. ...
				2	B-100	34.C. ...
006.1402.XX 006.1303.04				1	B-100	34.C. ...
				2	B-100	34.C. ...
006.1406.XX				2	H	34.C. ...
006.0305.XX				4	H - 150	34.C. ...
011.4631.--				3	B-100	34.C. ...
006.2340.XX				2	Bx1-15.5	34.C. ...
				2	Bx2+89	
				2	Bx3-15.5	
				6	H-114	
006.1342.XX				4	H-114	34.C. ...
006.1341.04				4	H-114	34.C. ...
006.1343.00				2	H-172	34.C. ...
030.3614.XX				2	Bx1-169.5	34.C. ...
				2	Bx2-65	
				2	Bx3-169.5	
				6	H-318	
(A) 0M0.1505.XX				1	Bx1-678.5	34.C. ...
				1	Bx2-574	
				1	Bx3-678.5	
(B) 0M0.1505.XX				6	40	34.C. ...
				1	Bx1-1302.5	
				1	Bx2-1198	
				1	Bx3-1302.5	

met dwarsstijl
avec traverse
with transom
mit Sprossenprofil
+

008.3114.XX				1	Bx1-169.5	34.C. ...
				1	Bx2-65	
				1	Bx3-169.5	

HOOGTE HAUTEUR HEIGHT HOEHE	MIN. 1780 MM
--------------------------------------	--------------

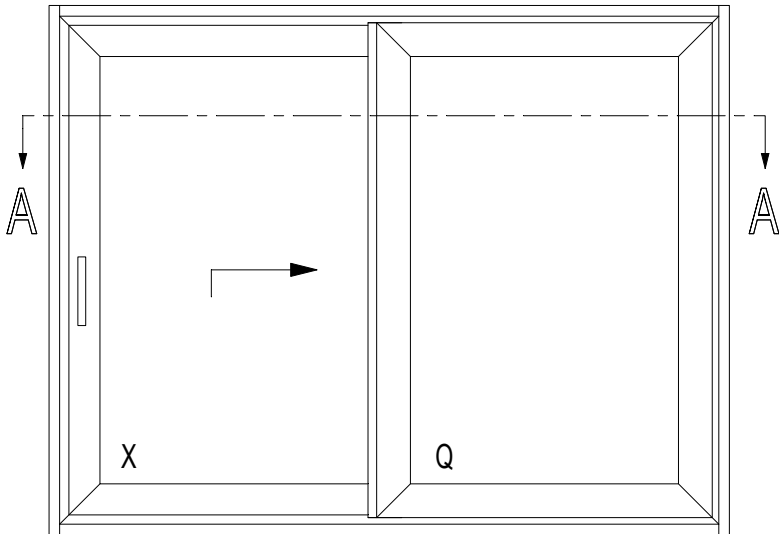

A - A

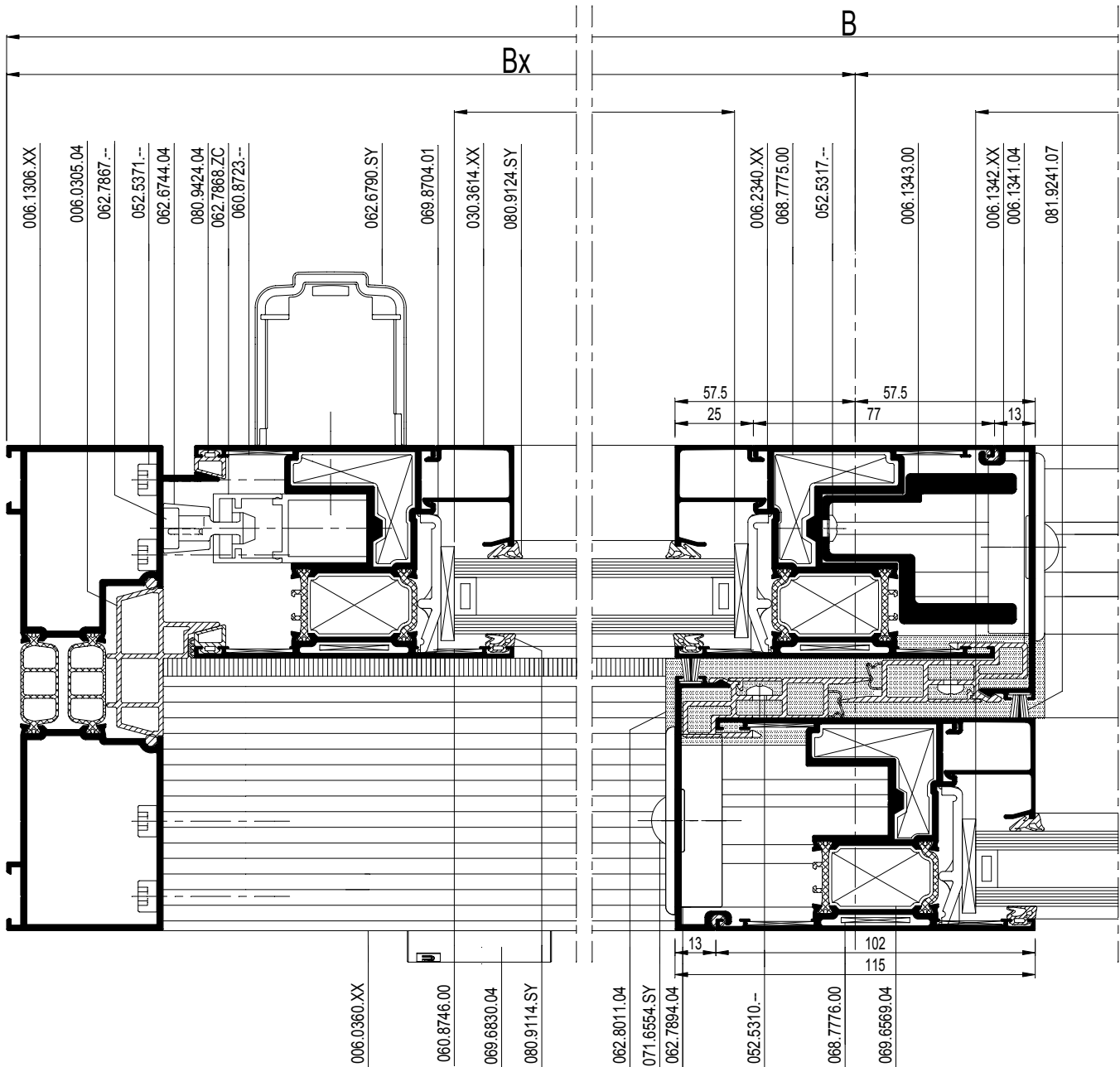

D0059817

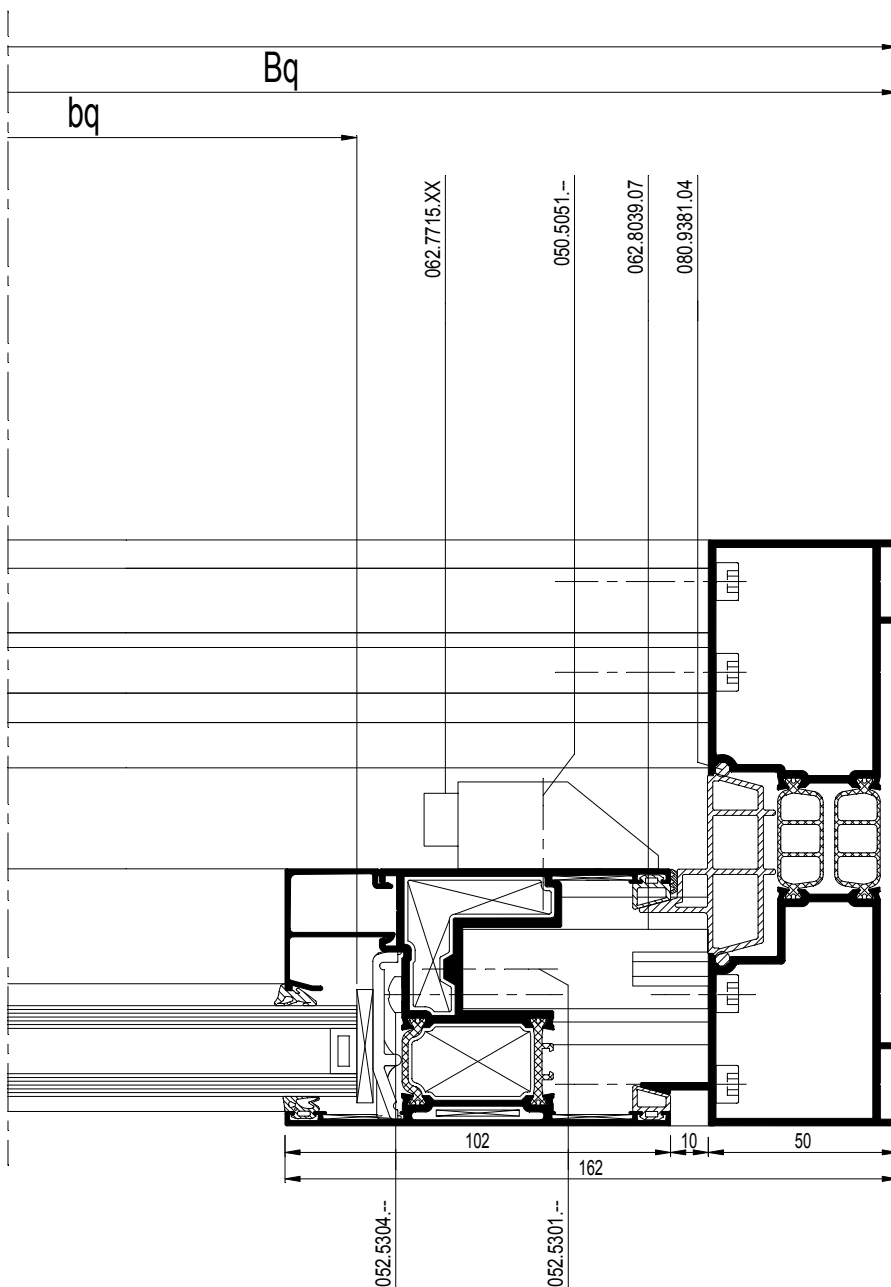

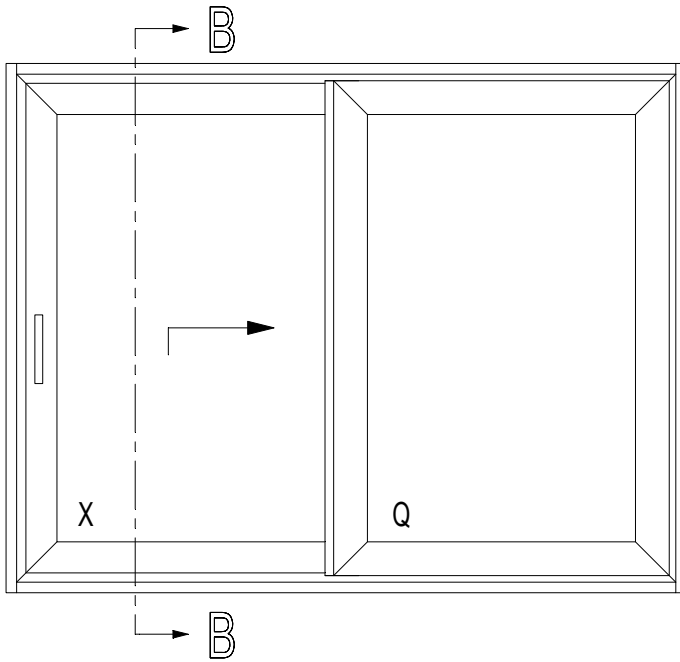

HOOGTE HAUTEUR HEIGHT HOEHE	MIN. 1780 MM
--------------------------------------	--------------

(A) VLEUGELGEWICHT POIDS DU VANTAIL WEIGHT OF THE VENT FLUEGELGEWICHT	MAX. 300KG
--	------------

(B) VLEUGELGEWICHT POIDS DU VANTAIL WEIGHT OF THE VENT FLUEGELGEWICHT	MIN. 300KG MAX. 400KG
--	--------------------------

D0059815

B - B

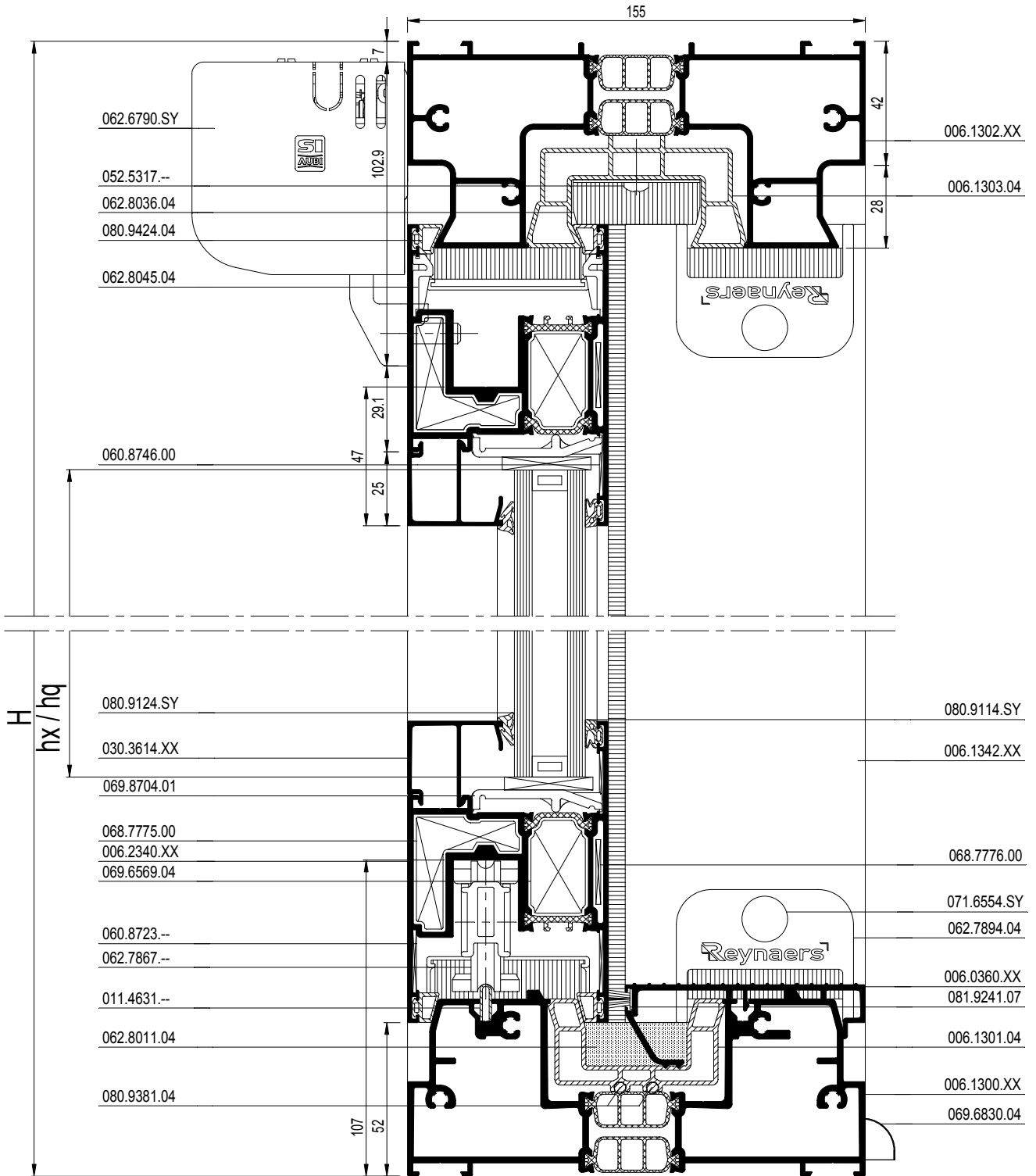

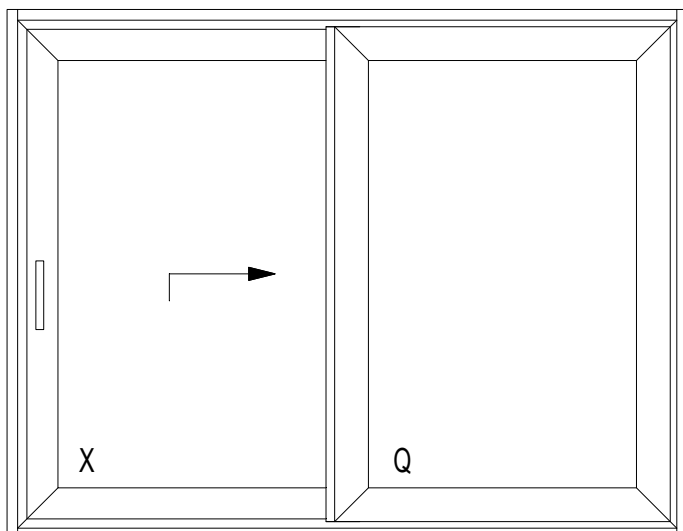

HOOGTE HAUTEUR HEIGHT HOEHE	MIN. 1895 MM
--------------------------------------	--------------

(A) VLEUGELGEWICHT POIDS DU VANTAIL WEIGHT OF THE VENT FLUEGELGEWICHT	MAX. 300KG
--	------------

(B) VLEUGELGEWICHT POIDS DU VANTAIL WEIGHT OF THE VENT FLUEGELGEWICHT	MIN. 300KG MAX. 400KG
--	--------------------------

			#	
	052.5371.--		16	34.G...
	062.9396.04		2	34.G...
	068.7775.00		8	34.G...
	069.6569.04		8	34.G...
	068.7776.00		8	34.G...
	060.8723.--		16	34.G...
	060.8746.00		8	34.G. ...
	062.7894.04		2	34.G....
	052.5317.--		4	34.G....
	071.6554.SY		4	34.G....
(A)	062.7867.--		1	34.G....
(B)	062.7867.--		1	34.G....
	062.7903.--		1	34.G....
(*)	062.7902.ZC <small>OF-OU-OR-ODER</small>		1	34.G....
	062.7868.ZC		1	34.G....
(A)	062.7715.XX		1	34.G....
	050.5051.--		1	34.G....
(B)	062.7715.XX		2	34.G.
	050.5051.--		2	34.G.
	057.5721.--		2	34.G.
	062.6744.04		2	34.G....
	053.5412.--		2	34.G....
	062.8038.07		3	34.G.
	052.5301.--		3	34.G.
	052.5304.--		3	34.G.
	062.8039.07		3	34.G.
	052.5301.--		3	34.G.
	052.5304.--		3	34.G.











































			#	
	062.8045.04		2	34.G....
	062.8011.04		1	34.G....
	062.8036.04		1	34.G....
	053.5317.--		2	34.G....
	052.5310.--		2xH (3/m)	34.G....
	052.5317.--		H (3/m)	34.G....
(**)	062.9372.04		2	34.G....
	062.9375.04		2	34.G....
(A)	069.8704.01		16 (-250KG)	34.G....
(A)	069.8704.01		12 (+250KG)	34.G....
	069.8724.04		4	34.G....
(B)	069.8704.01		12	34.G....
	069.8724.04		8	34.G....
	062.6857.04		1	34.G....
	069.6830.04		min. 2	34.G....
	080.9124.SY		(2xB)+(4xH)	34.G....
	080.9114.SY		(2xB)+(4xH)	34.G....
	080.9381.04		(2xB)+(6xH)	34.G....
	080.9424.04		(4xB)+(4xH)	34.G....
	081.9241.07		(2xH)+(Bx)	34.G....
	062.6790.SY		1	34.G....
	062.6793.XX		1	34.G....

VARIANT HI

080.9439.04		(1xB)+(3xH)	34.G.
080.9625.07		(2xB)+(4xH)	34.G.

(*) Afhankelijk van de hoogte
 Dépend de l'hauteur
 Dependent of the height
 Von der Höhe abhängig

(**) Afhankelijk van de positie van de primaire vleugel
 Dépend de la position de ouvrante principale
 depending on the position of the primary vent
 abhängig von der Position des primären Fluegel

				#	$\leftarrow L_m \rightarrow$	
bx = Bx-181.5 hx = H-280	006.1300.XX 006.1301.04			1	B-100	34.C...
bq = Bq-181.5 hq = H-280	006.1302.XX 006.1303.04			1	B-100	34.C...
	006.1306.XX			2	H	34.C...
	006.0305.04			2	H-150	34.C...
	011.4631.--			1	B-100	34.C...
	006.2340.XX			2	Bx-15.5	34.C...
				2	Bq-15.5	
				4	H-114	
	006.1342.XX			2	H-114	34.C...
	006.1341.04			2	H-114	34.C...
	006.1343.00			1	H-172	34.C...
	030.3614.XX			2	Bx-169.5	34.C...
				2	Bq-169.5	
				4	H-318	
	006.0360.XX			1	Bx-110.5	34.C...
(A)	0M0.1505.XX			1	Bx-678.5	34.C...
(B)	0M0.1505.XX			2	40	34.C...
				1	Bx-1302.5	34.C...
	006.0365.XX			1	B-120	34.C...

CP 155-LS/HI MINERGIE LABEL

MONORAIL XQ
MONORAIL XQ
MONORAIL XQ
MONORAIL XQ

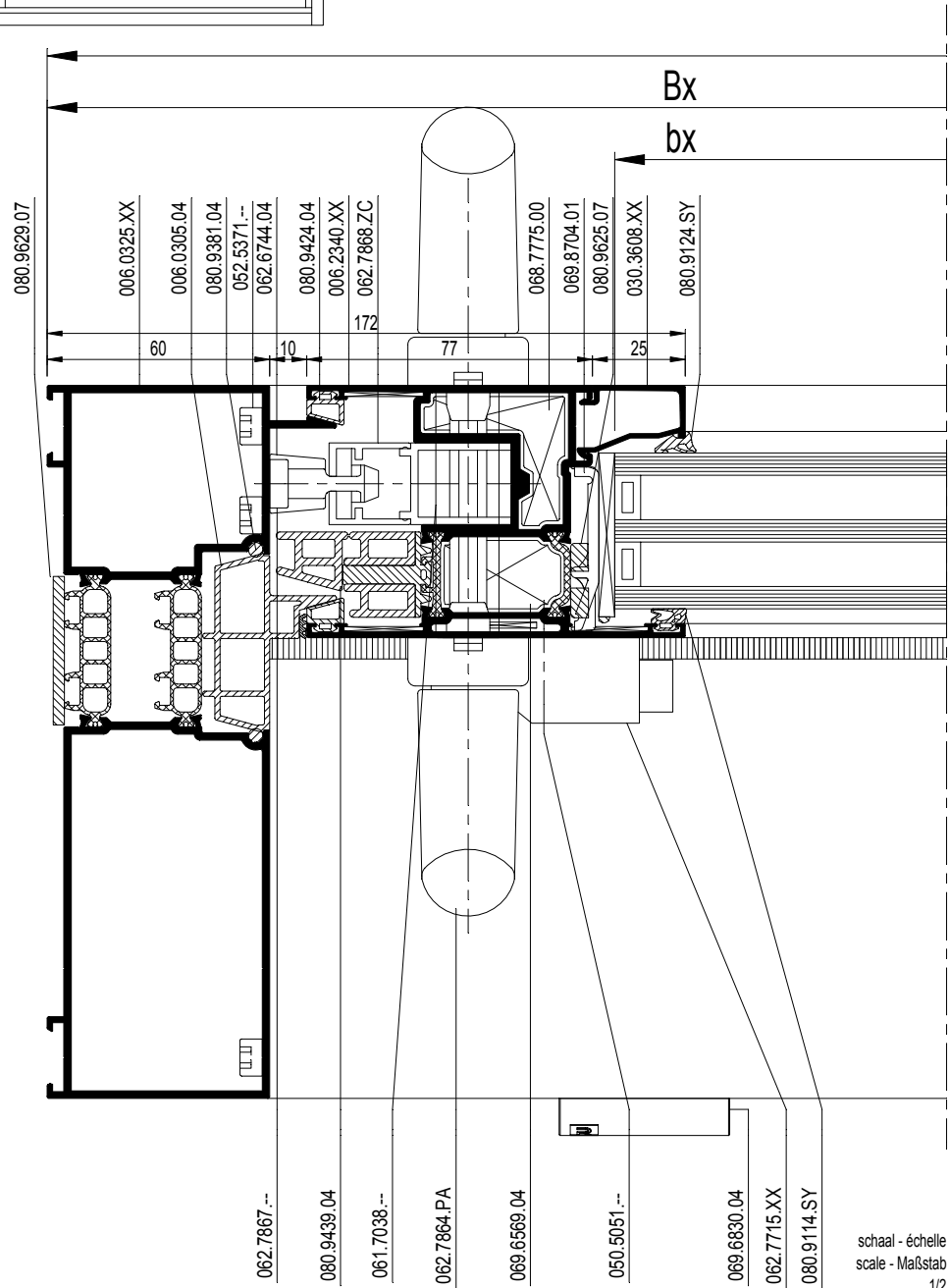
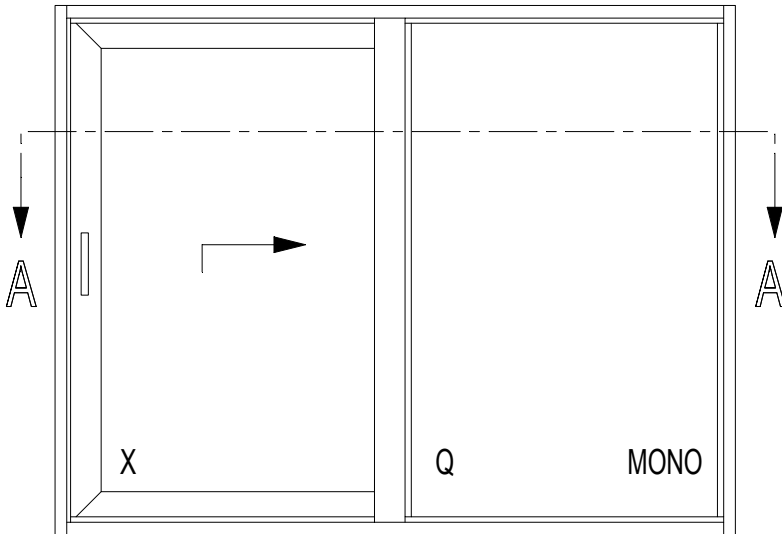

schaal - échelle
scale - Maßstab
1/2
D0083819

CP 155-LS/HI MINERGIE LABEL

MONORAIL XQ
MONORAIL XQ
MONORAIL XQ
MONORAIL XQ



(A)	VLEUGELGEWICHT POIDS DU VANTAIL WEIGHT OF THE VENT FLUEGELGEWICHT	MAX. 300KG
(B)	VLEUGELGEWICHT POIDS DU VANTAIL WEIGHT OF THE VENT FLUEGELGEWICHT	MIN. 300KG MAX. 400KG

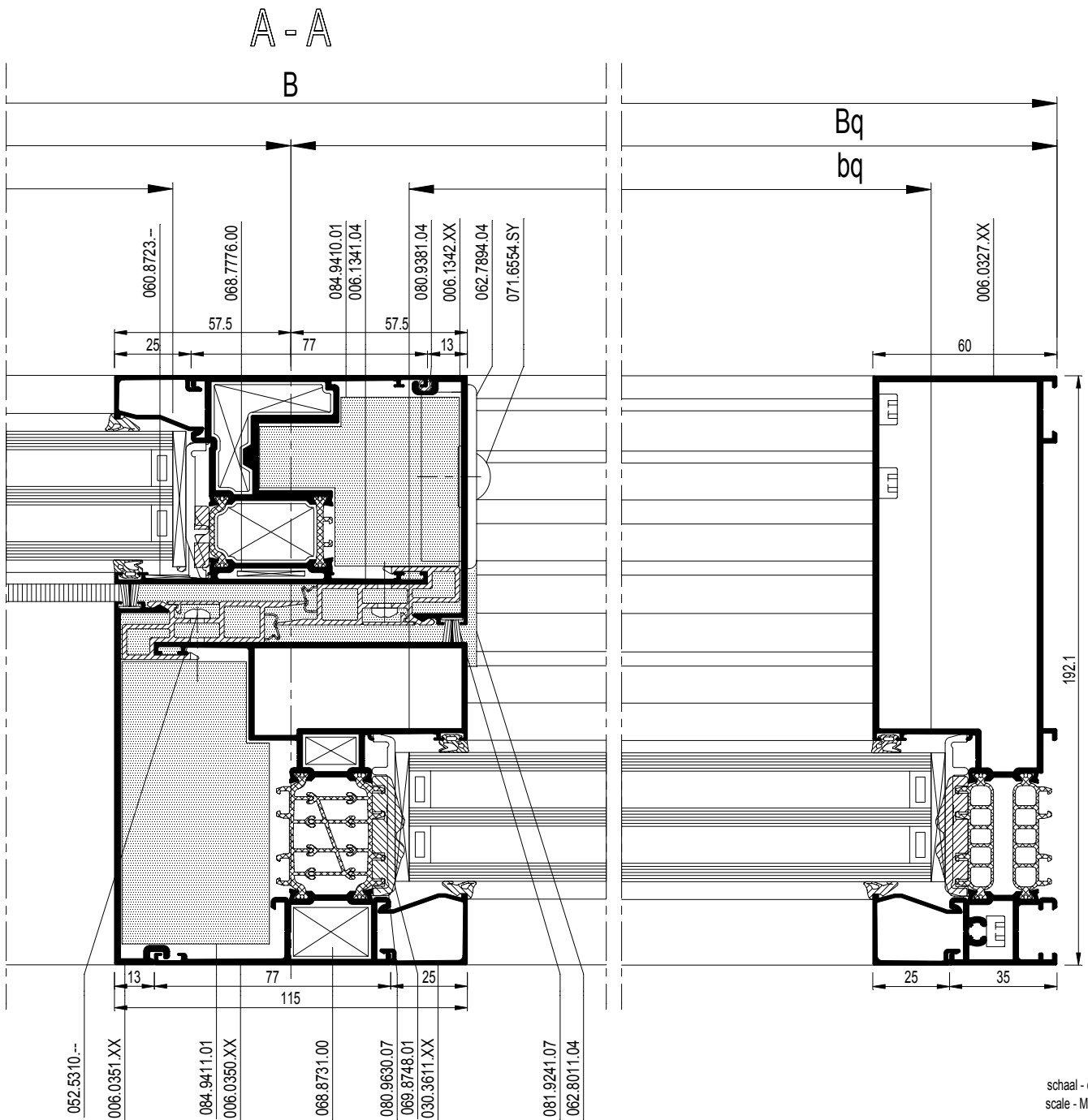

CP 155-LS/HI MINERGIE LABEL

MONORAIL XQ
MONORAIL XQ
MONORAIL XQ
MONORAIL XQ

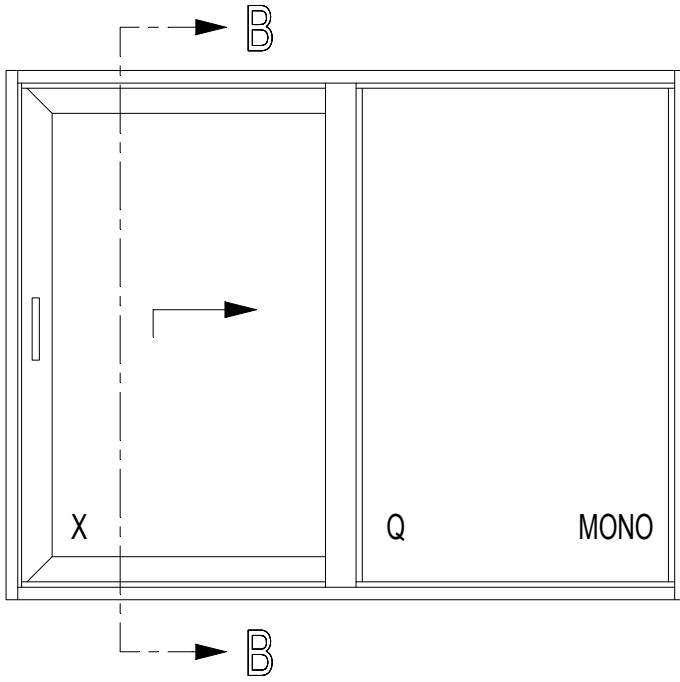

schaal - échelle
scale - Maßstab
1/2
D0083823

B - B

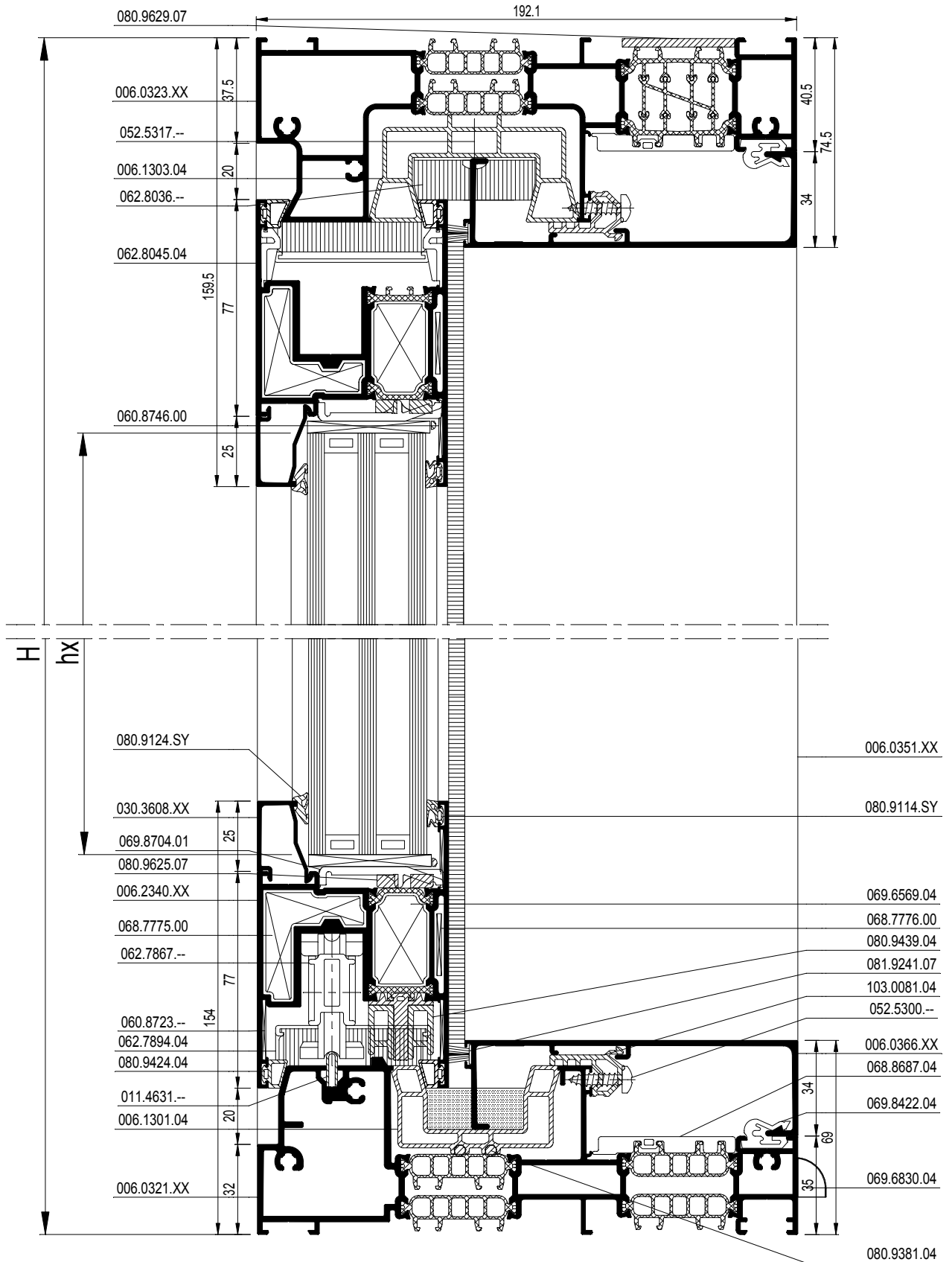

schaal - échelle
 scale - Maßstab
 1/2

D0083823

CP 155-LS/HI MINERGIE LABEL

MONORAIL XQ
MONORAIL XQ
MONORAIL XQ
MONORAIL XQ

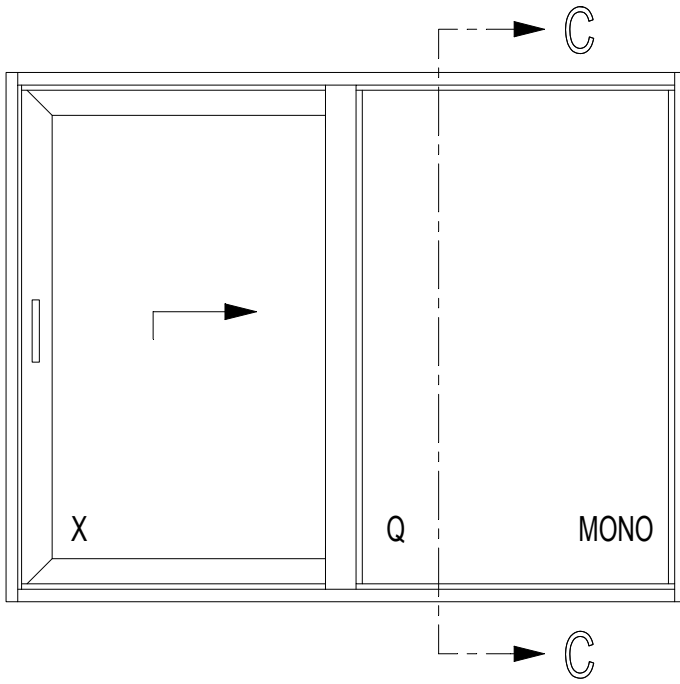

schaal - échelle
scale - Maßstab
1/2
D0090801

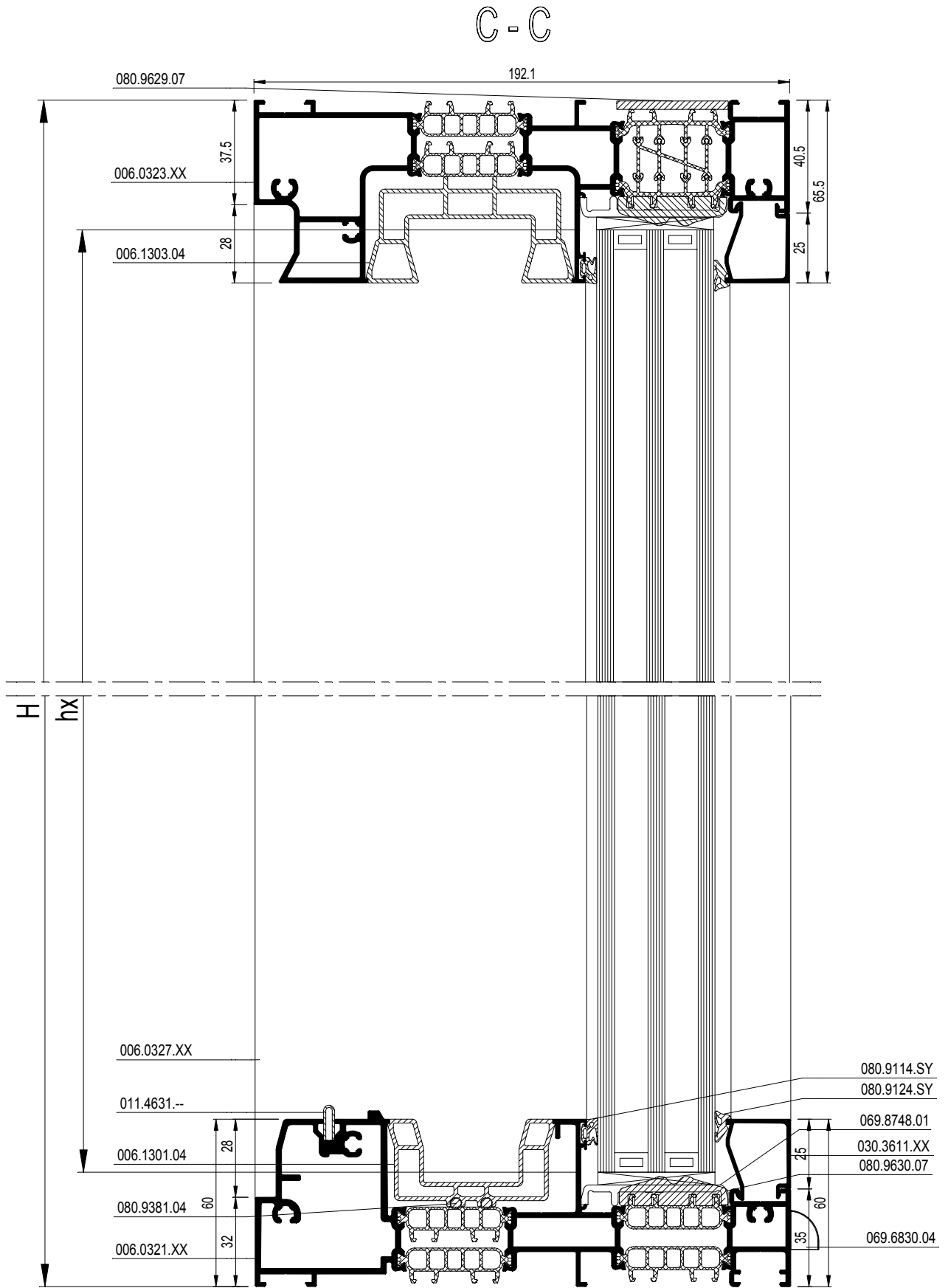

schaal - échelle
 scale - Maßstab
 1/2

D0090801

CP 155-LS/HI MINERGIE LABEL

MONORAIL XQ
MONORAIL XQ
MONORAIL XQ
MONORAIL XQ

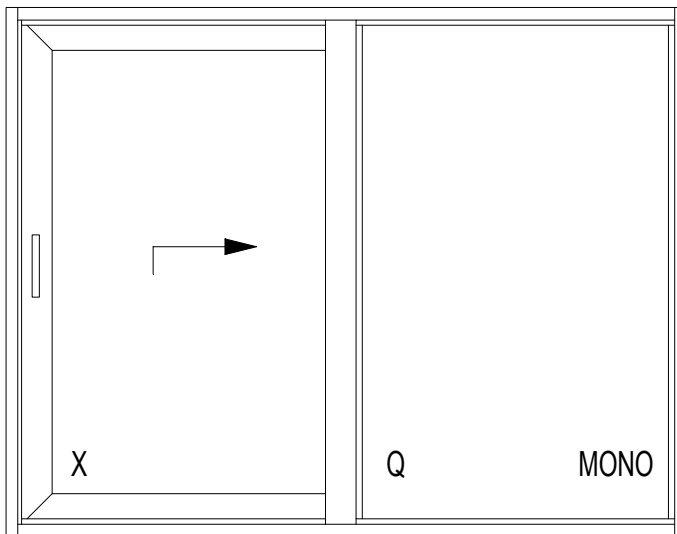





















































			#	
	052.5371.--		12	34.G...
	062.9393.04		2	34.G...
	068.7775.00		4	34.G...
	069.6569.04		4	34.G...
	068.7776.00		4	34.G...
	060.8723.--		12	34.G...
	060.8746.00		4	34.G...
	068.8731.00		2	34.G...
	068.8687.04		4	34.G...
	050.5153.--		4	34.G...
	068.8687.04		4	34.G...
	062.7894.--		1	34.G...
	052.8317.--		2	34.G...
	071.6554.SY		2	34.G...
(A)	062.7867.--		1	34.G...
(B)	062.7867.--		1	34.G...
	062.7903.--		1	34.G...
(*)	062.7902.ZC		1	34.G...
	062.7868.ZC		1	34.G...
	062.7864.PA		1	34.G...
	061.7038.--		1	34.G...
(A)	062.7715.XX		1	34.G...
	050.5051.--		1	34.G...
(B)	062.7715.XX		2	34.G...
	057.5721.--		2	34.G...
	050.5052.--		2	34.G...
	062.6744.04		2	34.G...
	053.5412.--		2	34.G...

			#	
	062.8045.04		2	34.G...
	062.8011.04		1	34.G...
	062.8036.04		1	34.G...
	052.5317.--		2	34.G...
	052.5310.--		2xH(3/m)	34.G...
	052.5300.--		2xBx(3/m)	34.G...
(**)	062.9372.04		1	34.G...
	062.9375.04		1	34.G...
(A)	069.8704.01		8(-250kg)	34.G...
(A)	069.8704.01		6(+250kg)	34.G...
	069.8724.04		2	34.G...
(B)	069.8704.01		6	34.G...
	069.8724.04		4	34.G...
	069.8748.01		8	34.G...
	069.8422.04		(2xBx)3/m	34.G...
	069.6830.04		min.2	34.G...
	069.6747.04		2	34.G...
	080.9124.SY		(2xB)+(4xH)	34.G...
	080.9114.SY		(2xb)+(4xH)	34.G...
	080.9381.04		(2xB)+(3xH)	34.G...
	080.9424.04		(4xBx)+(2xH)	34.G...
	081.9241.07		(2xBx)+(2xH)	34.G...
	080.9439.04		Bx+H	34.G...
	080.9625.07		(2xBx)+(2xH)	34.G...
	080.9630.07		(2xBq)+(2xH)	34.G...
	080.9629.07		B+H	34.G...
	084.9410.01		1	34.G...
	084.9411.01		1	34.G...

(*) Afhankelijk van de hoogte
Dépend de l'hauteur
Depending of the height
Von der Höhe abhängig

(**) Afhankelijk van de positie van de primaire vleugel
Dépend de la position de ouvrante principale
depending on the position of the primary vent
abhängig von der Position des primären Flügel

schaal - échelle
scale - Maßstab
1/2
D008396Z

				#		
bx=Bx-191.5	006.0321.XX			1	B-95	34.C...
hx=H-275.5	006.1301.04			1	B-120	34.C...
bq=Bq-79.5	006.0323.XX			1	B-95	34.C...
hq=H-87.5	006.1303.04			1	B-120	34.C...
	006.0325.XX			1	H	34.C...
	006.0327.XX			1	H	34.C...
	006.0305.04			1	H-145.5	34.C...
	006.2340.XX			2	Bx-25.5	34.C...
				2	H-109.5	34.C...
	006.0350.XX			1	H-75.5	34.C...
	006.1342.XX			1	H-109.5	34.C...
	006.0351.XX			1	H-75.5	34.C...
	006.1341.04			2	H-109.5	34.C...
	006.0366.XX			2	Bx-117.5	34.C...
	103.0081.04			2	Bx-117.5	34.C...
	030.3608.XX			2	Bx-179.5	34.C...
				2	H-313.5	34.C...
	030.3611.XX			2	Bq-67.5	34.C...
				2	H-125.5	34.C...
	011.4631.--			1	B-120	34.C...
(A)	0M0.1505.XX			1	Bx-688.5	34.C...
(B)	0M0.1505.XX			2	40	34.C...
				1	Bx-1312.5	34.C...

(A)	VLEUGELGEWICHT POIDS DU VANTAIL WEIGHT OF THE VENT FLUEGELGEWICHT	MAX. 300KG
-----	--	------------

(B)	VLEUGELGEWICHT POIDS DU VANTAIL WEIGHT OF THE VENT FLUEGELGEWICHT	MIN. 300KG MAX. 400KG
-----	--	--------------------------

CP 155-LS/HI MINERGIE LABEL

MONORAIL QXQ
MONORAIL QXQ
MONORAIL QXQ
MONORAIL QXQ

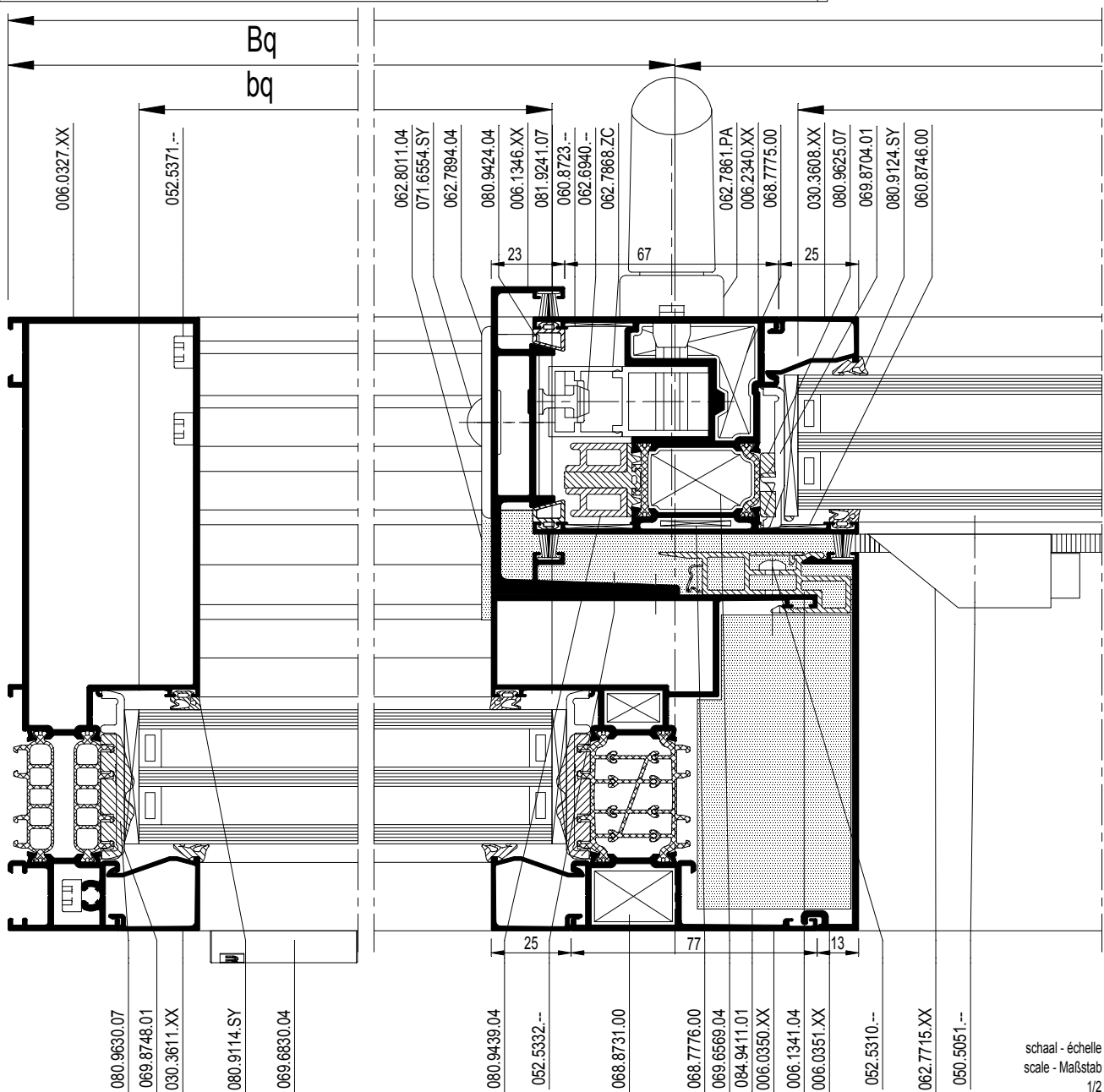
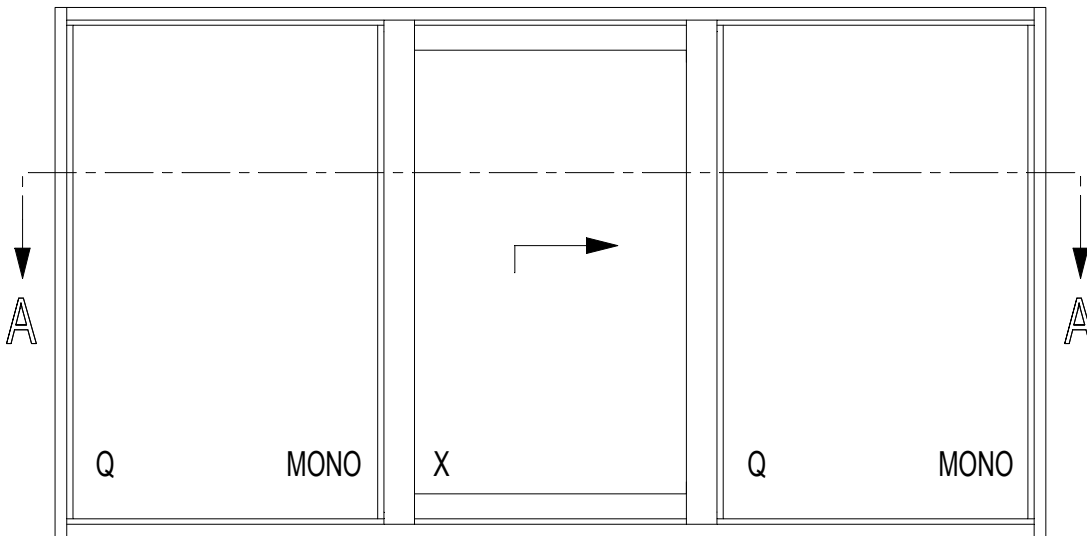

schaal - échelle
scale - Maßstab
1/2
D0083824

CP 155-LS/HI MINERGIE LABEL

MONORAIL OXO
MONORAIL OXO
MONORAIL OXO
MONORAIL OXO



(A)	VLEUGELGEWICHT POIDS DU VANTAIL WEIGHT OF THE VENT FLUEGELGEWICHT	MAX. 300KG
(B)	VLEUGELGEWICHT POIDS DU VANTAIL WEIGHT OF THE VENT FLUEGELGEWICHT	MIN. 300KG MAX. 400KG

A - A

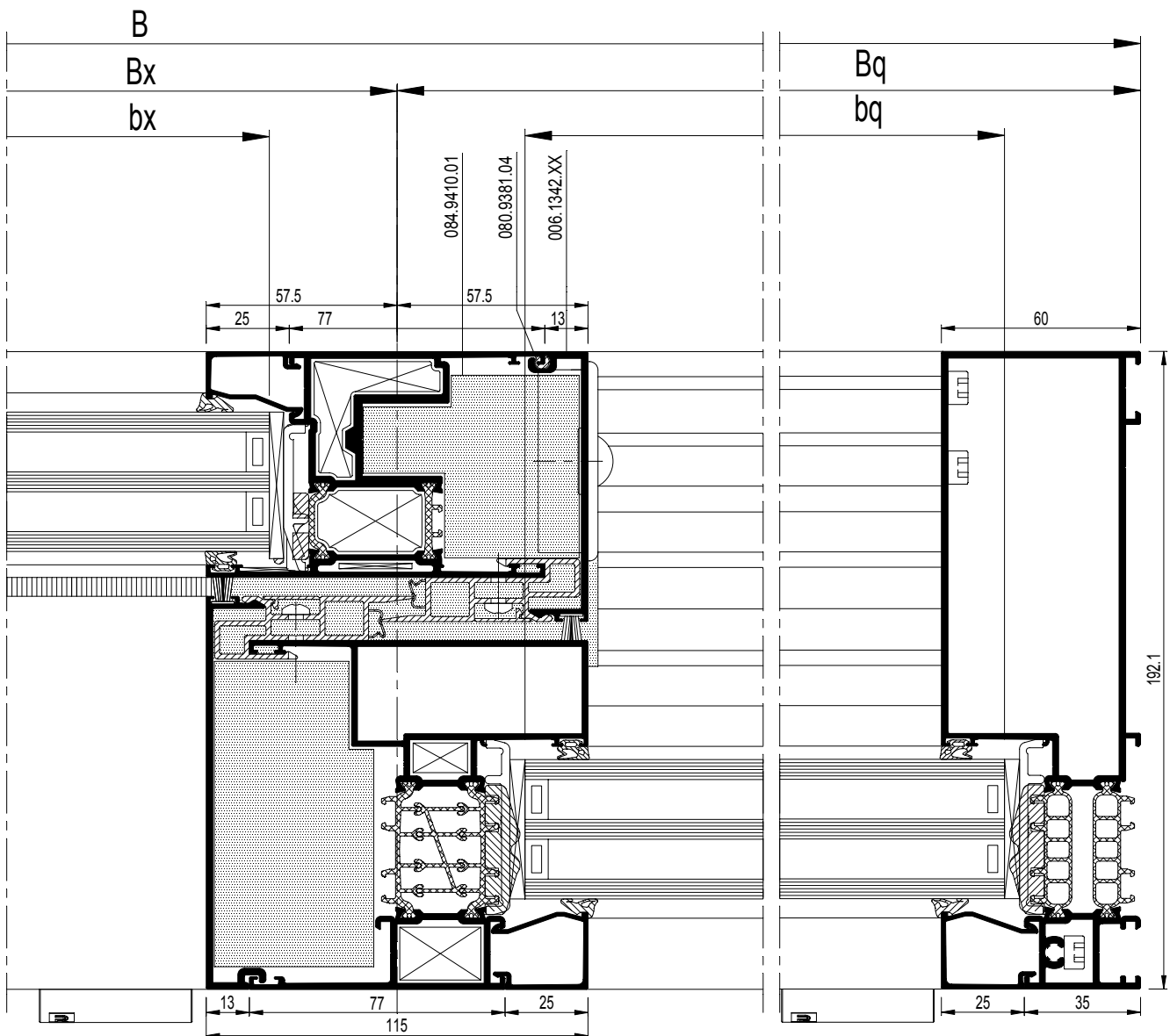

schaal - échelle
scale - Maßstab
1/2

D0083824

CP 155-LS/HI MINERGIE LABEL

MONORAIL QXQ
MONORAIL QXQ
MONORAIL QXQ
MONORAIL QXQ

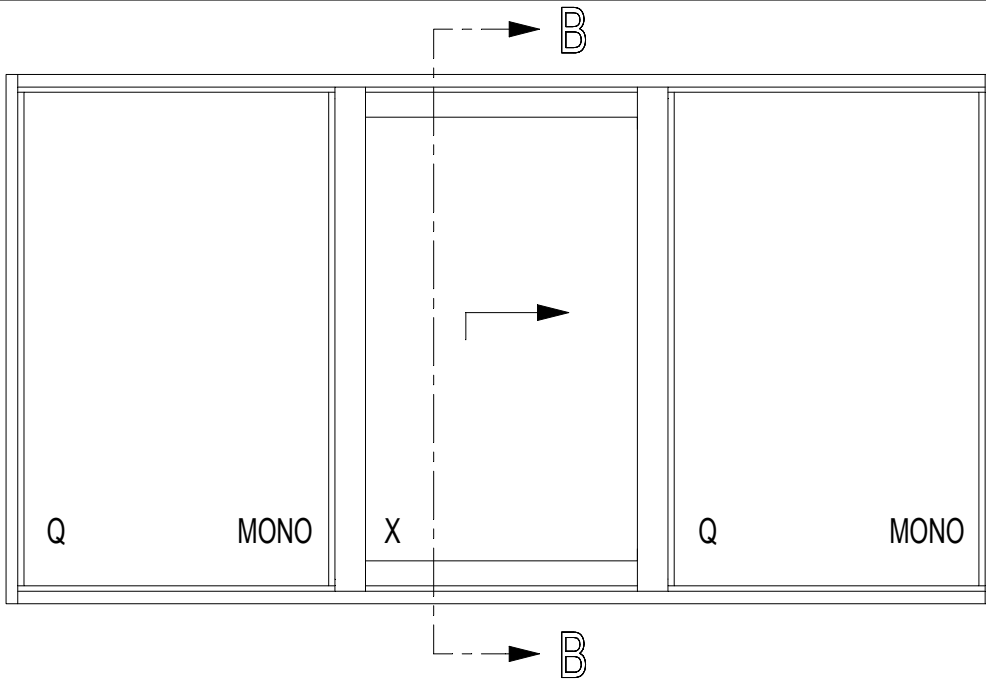

(A)	VLEUGELGEWICHT POIDS DU VANTAIL WEIGHT OF THE VENT FLUEGELGEWICHT	MAX. 300KG
	(B)	VLEUGELGEWICHT POIDS DU VANTAIL WEIGHT OF THE VENT FLUEGELGEWICHT

D0083827

B - B

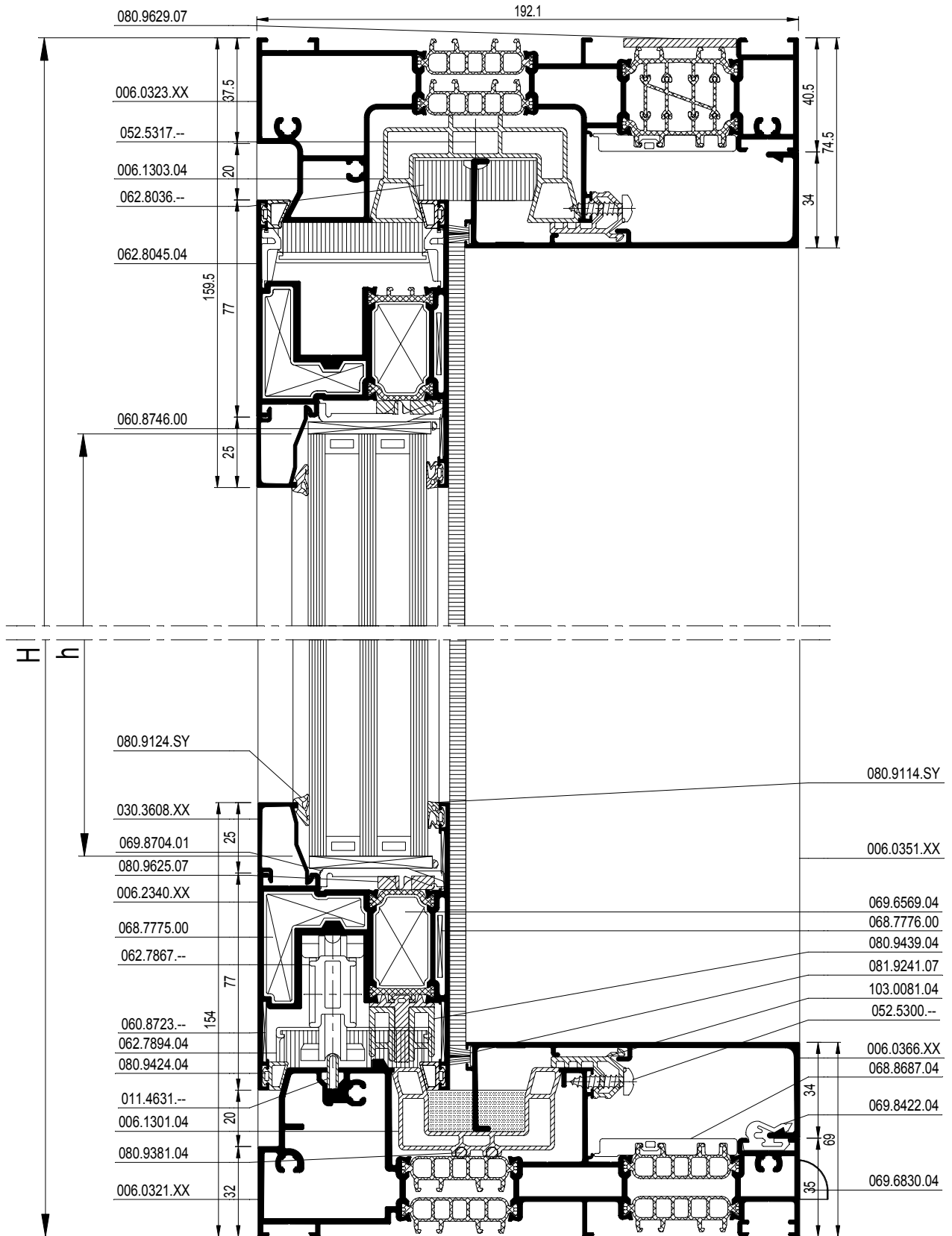

schaal - échelle
 scale - Maßstab
 1/2

D0083827

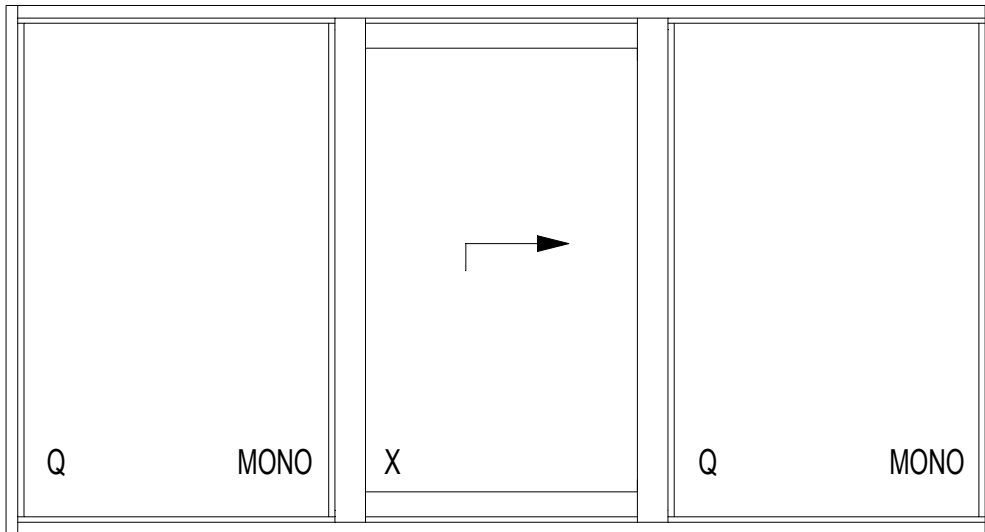

			#	
	052.5371.--		12	34.G...
	062.9393.04		2	34.G...
	068.7775.00		4	34.G...
	069.6569.04		4	34.G...
	068.7776.00		4	34.G...
	060.8723.--		8	34.G...
	060.8746.00		4	34.G...
	068.8731.00		4	34.G...
	068.8687.04		8	34.G...
	050.5153.--		8	34.G...
	068.8687.04		8	34.G...
	062.7894.--		2	34.G...
	052.8317.--		4	34.G...
	071.6554.XX		4	34.G...
(A)	062.7867.--		1	34.G...
(B)	062.7867.--		1	34.G...
	062.7903.--		1	34.G...
(*)	062.7902.ZC		1	34.G...
	062.7868.ZC		1	34.G...
	062.7861.PA		1	34.G...
	050.5011.--		2	34.G...
(A)	062.7715.XX		1	34.G...
	050.5051.--		2	34.G...
(B)	062.7715.XX		2	34.G...
	057.5721.--		2	34.G...
	050.5052.--		2	34.G...
	062.7717.04		2	34.G...
	062.6940.--		1	34.G...

	062.8045.04		2	34.G...
	062.8011.04		2	34.G...
	062.8036.04		2	34.G...
	052.5317.--		4	34.G...
	052.5310.--		3xH(3/m)	34.G...
	052.5300.--		2xBx(3/m)	34.G...
	052.5332.--		2xH(3/m)	34.G...
(A)	069.8704.01		8(-250kg)	34.G...
(A)	069.8704.01		6(+250kg)	34.G...
	069.8724.04		2	34.G...
(B)	069.8704.01		6	34.G...
	069.8724.04		4	34.G...
	069.8748.01		16	34.G...
	069.8422.04		(2xBx)3/m	34.G...
	069.6830.04		min. 2	34.G...
	069.6747.04		4	34.G...
	080.9124.SY		(2xB)+(6xH)	34.G...
	080.9114.SY		(2xB)+(6xH)	34.G...
	080.9381.04		(2xB)+(1xH)	34.G...
	080.9424.04		(4xBx)+(2xH)	34.G...
	081.9241.07		(2xBx)+(5xH)	34.G...
	080.9439.04		Bx+H	34.G...
	080.9625.07		(2xBx)+(2xH)	34.G...
	080.9630.07		(4xBq)+(4xH)	34.G...
	080.9629.07		B	34.G...
	084.9410.01		1	34.G...
	084.9411.01		2	34.G...

(*) Afhankelijk van de hoogte
Dépend de l'hauteur
Dependent of the height
Von der Höhe abhängig

CP 155-LS/HI MINERGIE LABEL

MONORAIL OXO
MONORAIL OXO
MONORAIL OXO
MONORAIL OXO



			#	$\leftarrow L_m \rightarrow$	
006.0321.XX			1	B-70	34.C....
006.1301.04			1	B-120	34.C....
006.0323.XX			1	B-70	34.C....
006.1303.04			1	B-120	34.C....
006.0327.XX			2	H	34.C....
006.2340.XX			2	Bx+89	34.C....
			2	H-109.5	34.C....
006.0350.XX			2	H-75.5	34.C....
006.1342.XX			1	H-109.5	34.C....
006.0351.XX			2	H-75.5	34.C....
006.1341.04			3	H-109.5	34.C....
006.0366.XX			2	Bx-115	34.C....
103.0081.04			2	Bx-115	34.C....
030.3608.XX			2	Bx-65	34.C....
			2	H-313.5	34.C....
030.3611.XX			4	Bq-67.5	34.C....
			4	H-125.5	34.C....
011.4631.--			1	B-120	34.C....
006.1346.XX			1	H-109.5	34.C....
(A) 0M0.1505.XX			1	BX-574	34.C....
(B) 0M0.1505.XX			2	40	34.C....
			1	BX-1198	34.C....

bx=BX-77
hx=H-275.5
bq=BQ-79.5
hq=H-87.5

(A)	VLEUGELGEWICHT POIDS DU VANTAIL WEIGHT OF THE VENT FLUEGELGEWICHT	MAX. 300KG
-----	--	------------

(B)	VLEUGELGEWICHT POIDS DU VANTAIL WEIGHT OF THE VENT FLUEGELGEWICHT	MIN. 300KG MAX. 400KG
-----	--	--------------------------

schaal - échelle
scale - Maßstab
1/2

D0083969

CP 155-LS/Hi MINERGIE LABEL

MONORAIL XQX
MONORAIL XQX
MONORAIL XQX
MONORAIL XQX

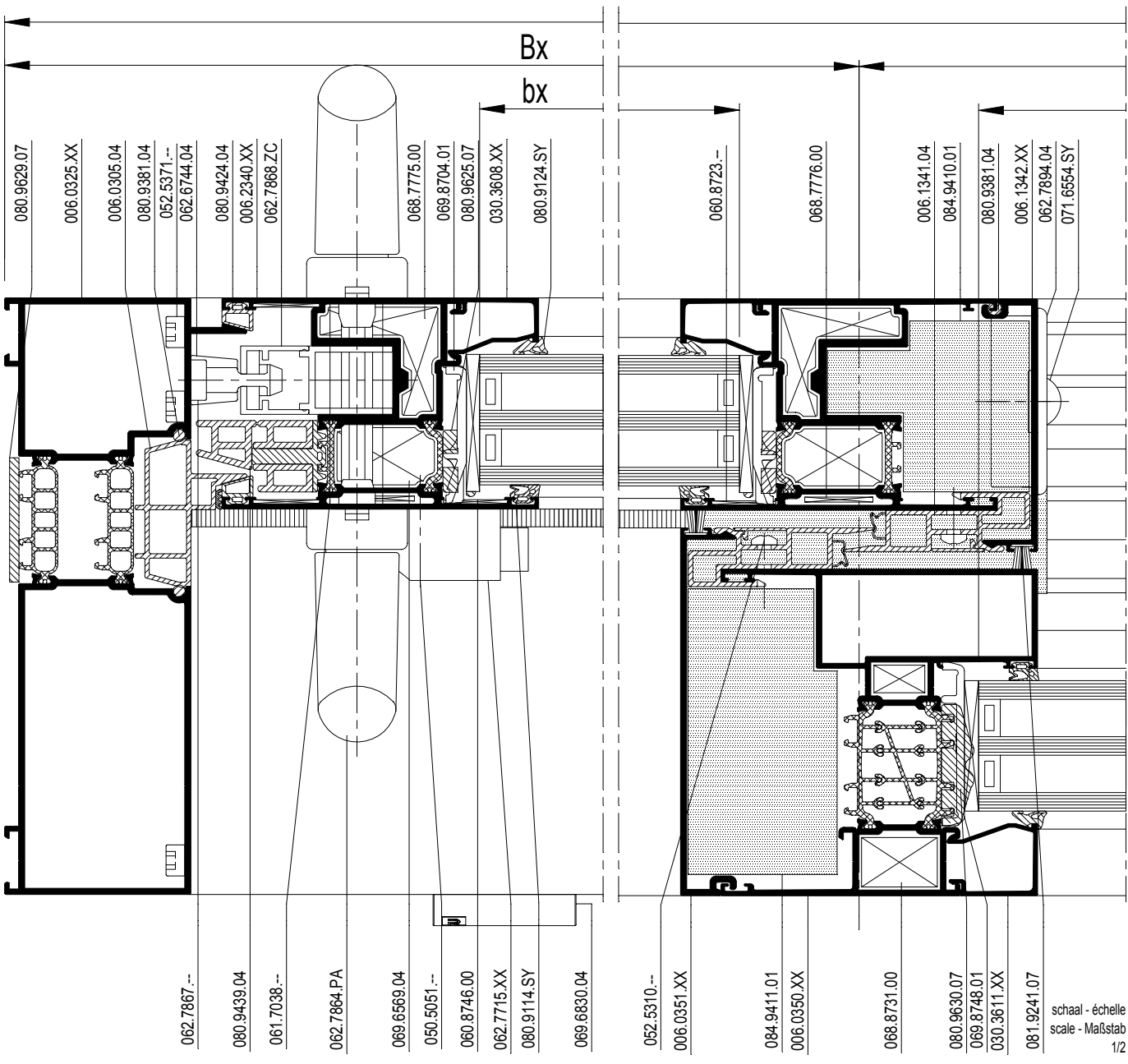
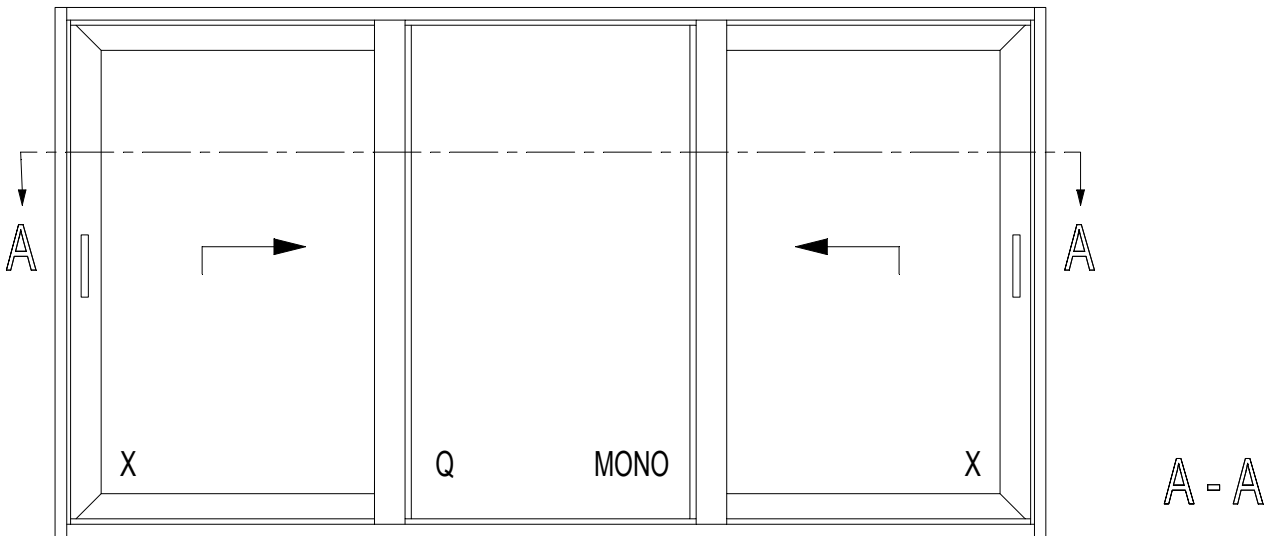

CP 155-LS/HI MINERGIE LABEL

MONORAIL QOX
MONORAIL QOX
MONORAIL QOX
MONORAIL QOX



(A)	VLEUGELGEWICHT POIDS DU VANTAIL WEIGHT OF THE VENT FLUEGELGEWICHT	MAX. 300KG
(B)	VLEUGELGEWICHT POIDS DU VANTAIL WEIGHT OF THE VENT FLUEGELGEWICHT	MIN. 300KG MAX. 400KG

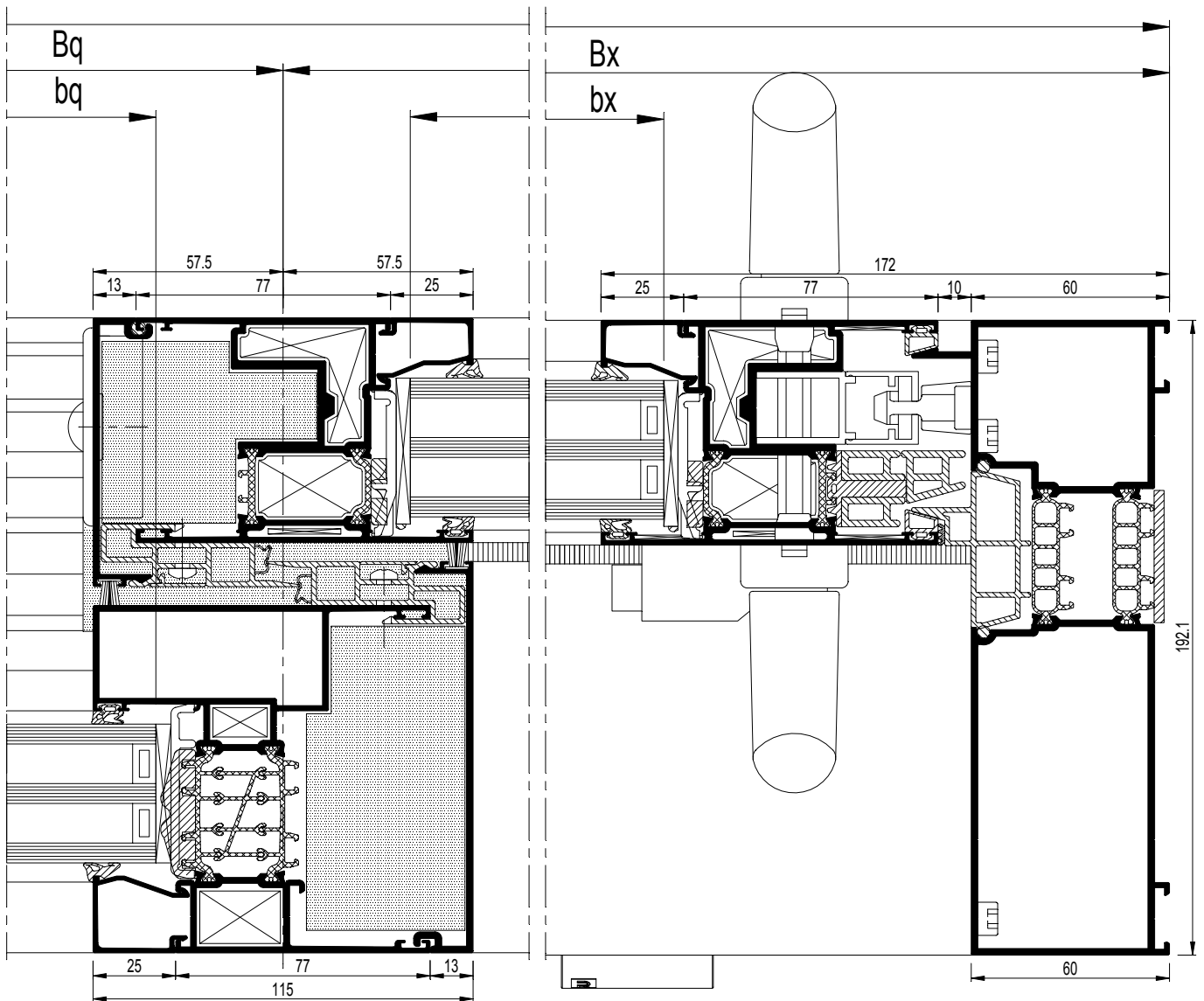

schaal - échelle
scale - Maßstab
1/2

D0083971

CP 155-LS/HI MINERGIE LABEL

MONORAIL XQX
MONORAIL XQX
MONORAIL XQX
MONORAIL XQX

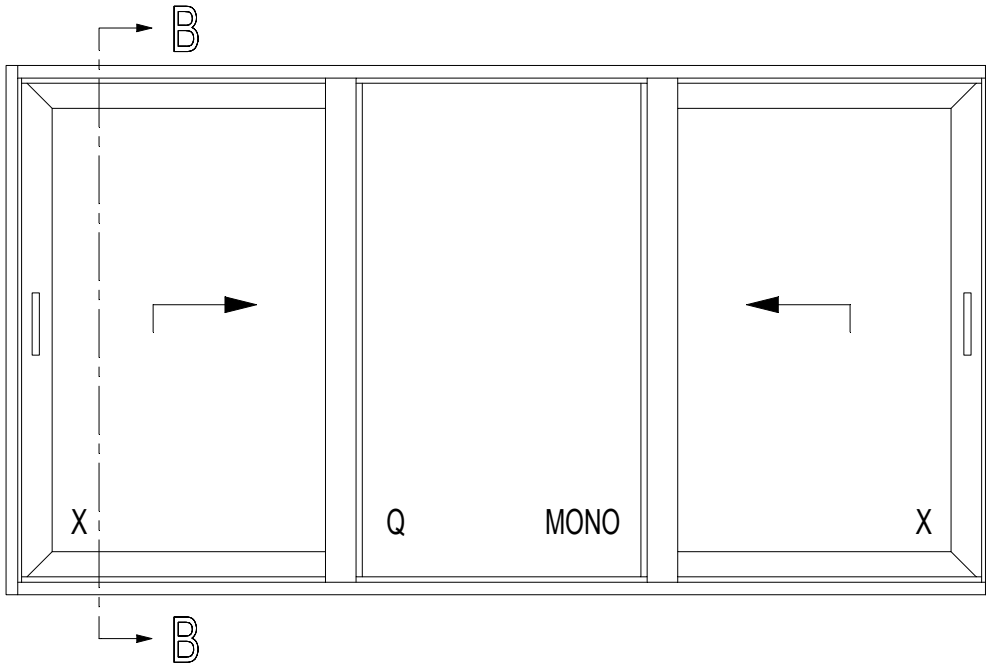

(A)	VLEUGELGEWICHT	MAX. 300KG
	POIDS DU VANTAIL	
	WEIGHT OF THE VENT	
	FLUEGELGEWICHT	
(B)	VLEUGELGEWICHT	MIN. 300KG MAX. 400KG
	POIDS DU VANTAIL	
	WEIGHT OF THE VENT	
	FLUEGELGEWICHT	

D0083972

D - D

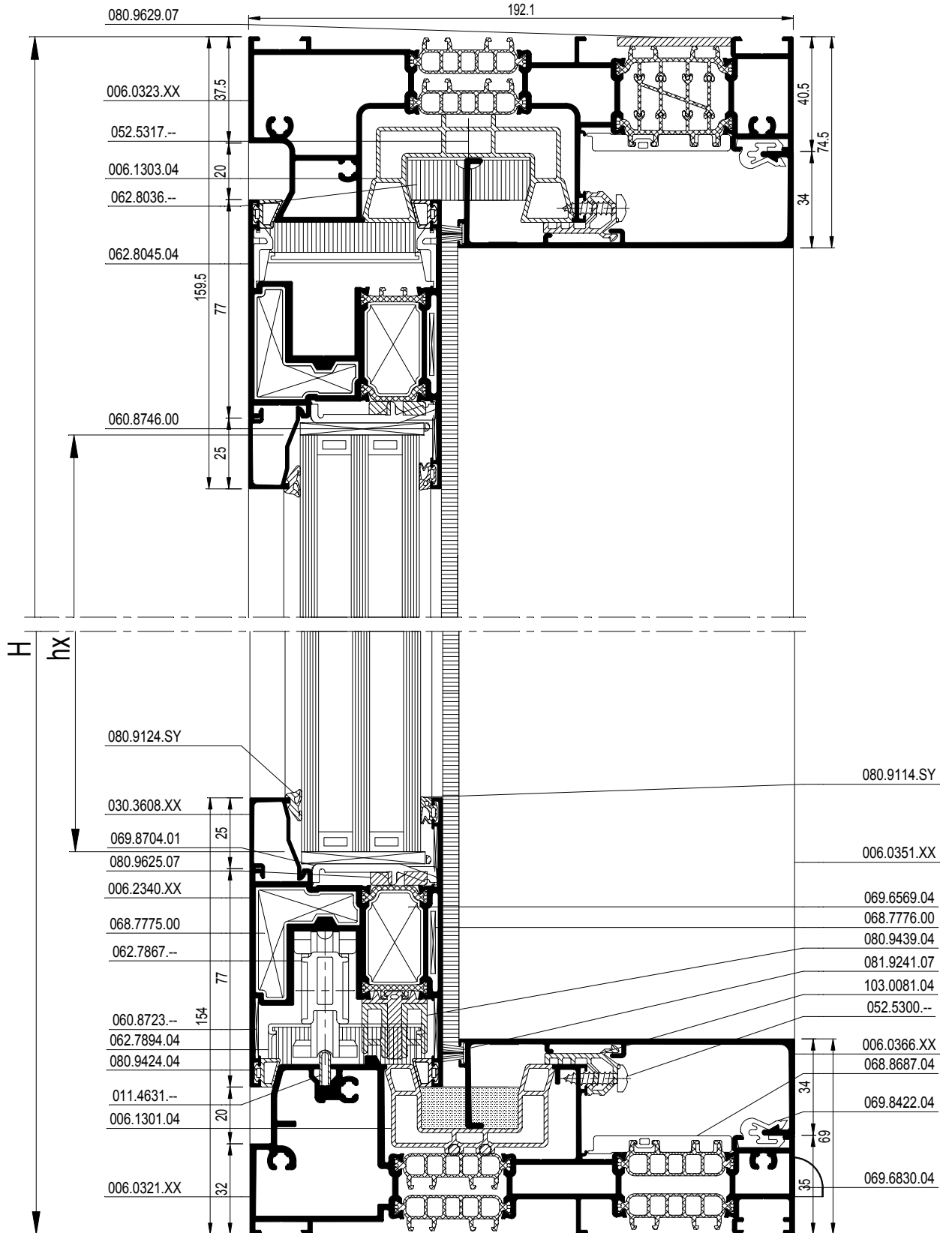

schaal - échelle
 scale - Maßstab
 1/2



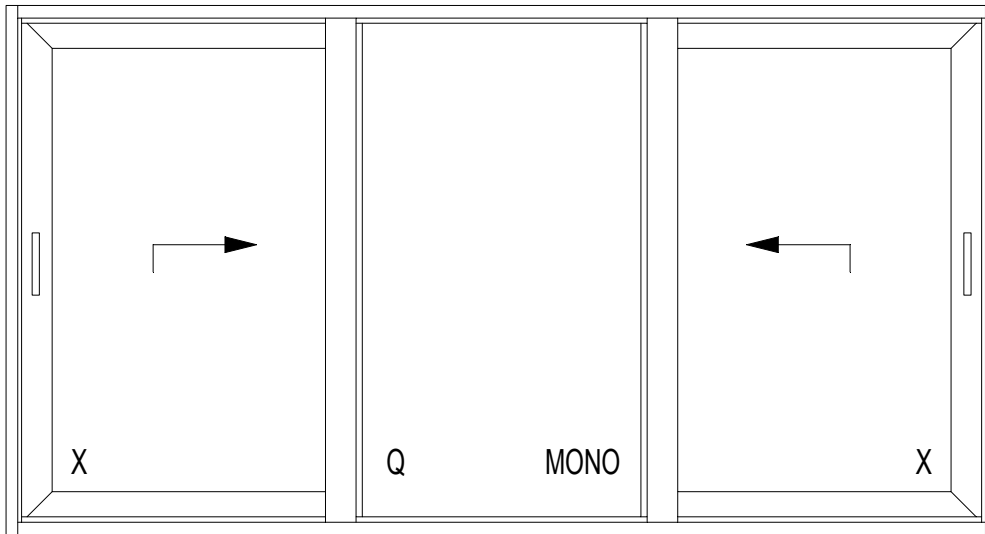























D0083972



			#	
	052.5371.--		12	34.G...
	062.9393.04		2	34.G...
	068.7775.00		8	34.G...
	069.6569.04		8	34.G...
	068.7776.00		8	34.G...
	060.8723.--		16	34.G...
	060.8746.00		8	34.G...
	068.8731.00		4	34.G...
	068.8687.04		8	34.G...
	050.5153.--		8	34.G...
	062.7894.--		2	34.G...
	052.8317.--		4	34.G...
	071.6554.XX		4	34.G...
(A)	062.7867.--		2	34.G...
(B)	062.7867.--		2	34.G...
	062.7903.--		2	34.G...
(*)	062.7902.ZC <small>OF-DUUR-ORDER</small>		2	34.G...
	062.7868.ZC		2	34.G...
	062.7864.PA		2	34.G...
	061.7038.--		2	34.G...
(A)	062.7715.XX		2	34.G...
	050.5051.--		2	34.G...
(B)	062.7715.XX		4	34.G...
	057.5721.--		4	34.G...
	050.5052.--		4	34.G...
	062.6744.04		4	34.G...
	053.5412.--		4	34.G...
	062.8045.04		4	34.G...

			#	
	062.8011.04		2	34.G...
	062.8036.04		2	34.G...
	052.5317.--		4	34.G...
	052.5310.--		4xH(3/m)	34.G...
	052.5300.--		4xBx(3/m)	34.G...
	062.9372.04		1	34.G...
	062.9375.04		1	34.G...
(A)	069.8704.01		16(-250kg)	34.G...
(A)	069.8704.01		12(+250kg)	34.G...
	069.8724.04		4	34.G...
(B)	069.8704.01		12	34.G...
	069.8724.04		8	34.G...
	069.8748.01		8	34.G...
	069.8422.04		4xBx(3/m)	34.G...
	069.6830.04		min. 2	34.G...
	069.6747.04		2	34.G...
	080.9124.SY		(2xB)+(6xH)	34.G...
	080.9114.SY		(2xb)+(6xH)	34.G...
	080.9381.04		(2xB)+(6xH)	34.G...
	080.9424.04		(8xBx)+(4xH)	34.G...
	081.9241.07		(4xBx)+(4xH)	34.G...
	080.9439.04		(2xBx)+(2xH)	34.G...
	080.9625.07		(4xBx)+(4xH)	34.G...
	080.9630.07		(2xBq)+(2xH)	34.G...
	080.9629.07		B+(2xH)	34.G...
	084.9410.01		2	34.G...
	084.9411.01		2	34.G...

(*) Afhankelijk van de hoogte
Dépend de l'hauteur
Dependent of the height
Von der Höhe abhängig

			#	$\leftarrow L_m \rightarrow$	
bx=Bx-191.5	006.0321.XX		1	B-120	34.C...
hx=H-275.5	006.1301.04		1	B-120	34.C...
bq=Bq-77	006.0323.XX		1	B-120	34.C...
hq=H-87.5	006.1303.04		1	B-120	34.C...
	006.0325.XX		2	H	34.C...
	006.0305.04		2	H-145.5	34.C...
	006.2340.XX		4	Bx-25.5	34.C...
			4	H-109.5	34.C...
	006.0350.XX		2	H-75.5	34.C...
	006.1342.XX		2	H-109.5	34.C...
	006.0351.XX		2	H-75.5	34.C...
	006.1341.04		4	H-109.5	34.C...
	006.0366.XX		4	Bx-117.5	34.C...
	103.0081.04		4	Bx-117.5	34.C...
	030.3608.XX		4	Bx-179.5	34.C...
			4	H-313.5	34.C...
	030.3611.XX		2	Bq-65	34.C...
			2	H-125.5	34.C...
	011.4631.--		1	B-120	34.C...
(A)	0M0.1505.XX		2	Bx-688.5	34.C...
(B)	0M0.1505.XX		4	40	34.C...
			2	Bx-1312.5	34.C...

(A)	VLEUGELGEWICHT POIDS DU VANTAIL WEIGHT OF THE VENT FLUEGELGEWICHT	MAX. 300KG
-----	--	------------

(B)	VLEUGELGEWICHT POIDS DU VANTAIL WEIGHT OF THE VENT FLUEGELGEWICHT	MIN. 300KG MAX. 400KG
-----	--	--------------------------

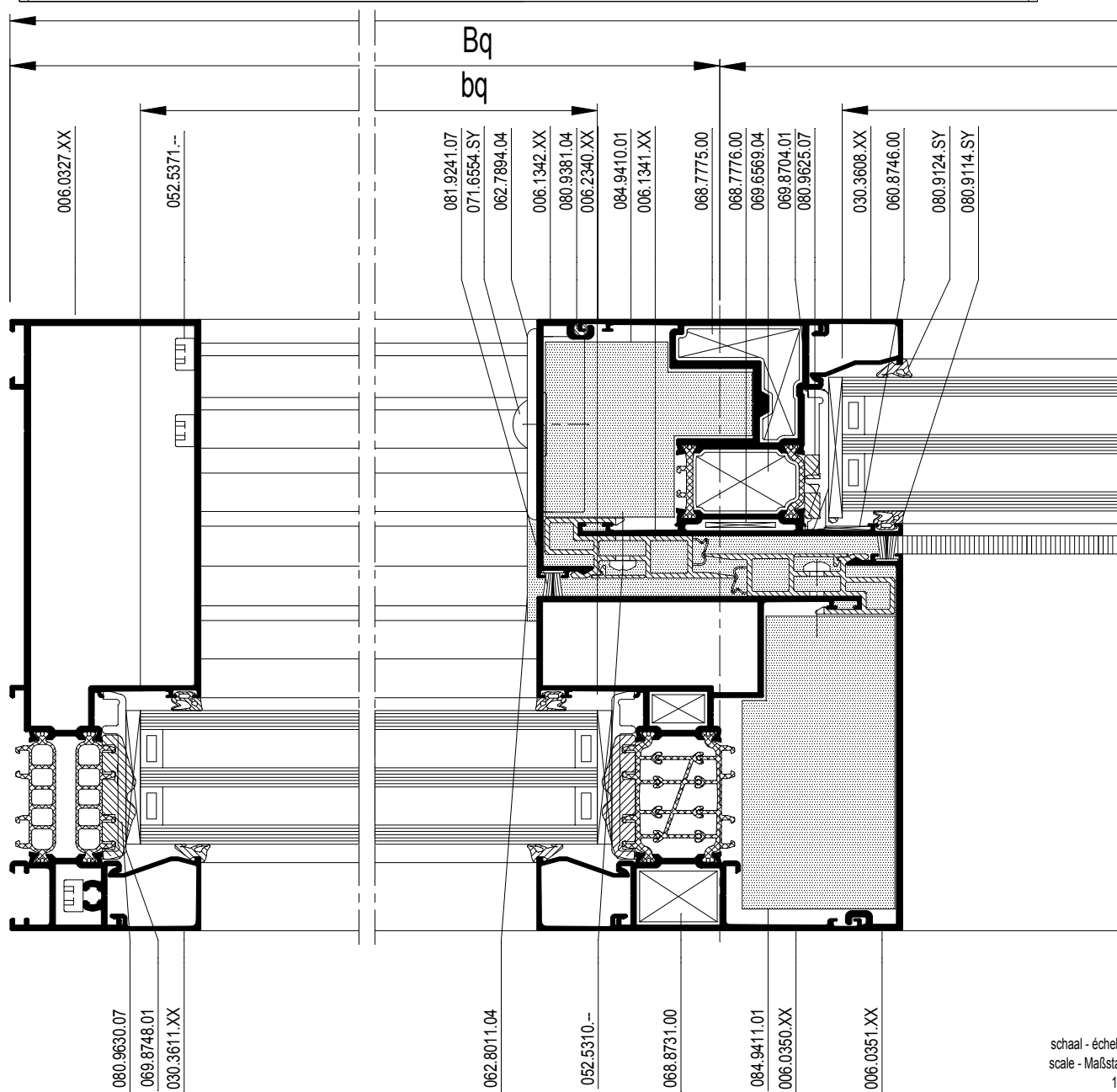
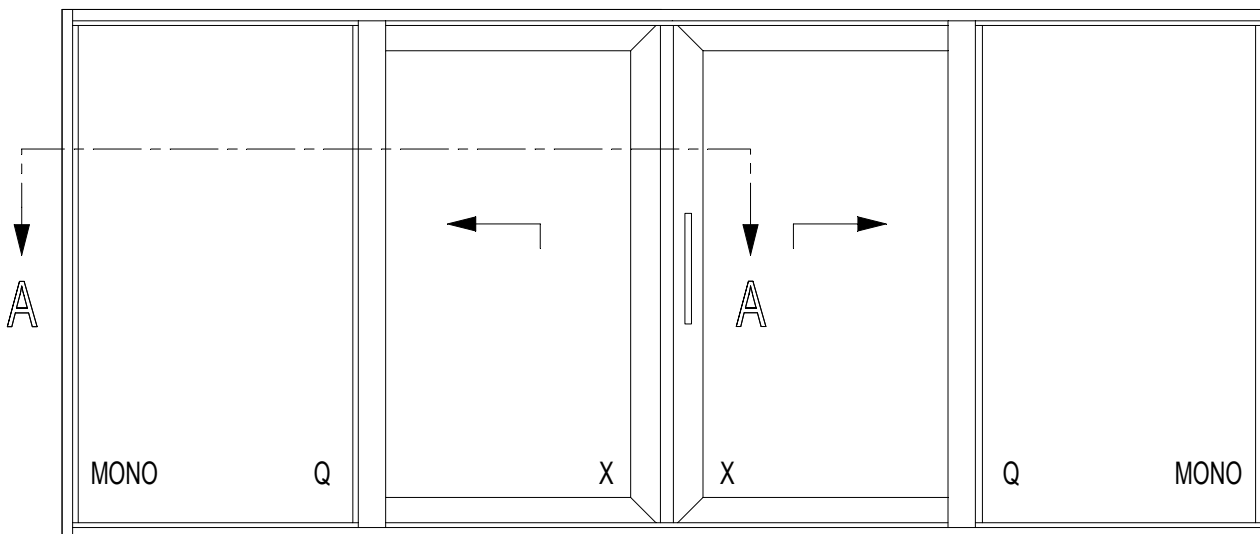

schaal - échelle
scale - Maßstab
1/2
D0083829

CP 155-LS/HI MINERGIE LABEL

MONORAIL OXXQ
MONORAIL OXXQ
MONORAIL OXXQ
MONORAIL OXXQ



(A)	VLEUGELGEWICHT POIDS DU VANTAIL WEIGHT OF THE VENT FLUEGELGEWICHT	MAX. 300KG
(B)	VLEUGELGEWICHT POIDS DU VANTAIL WEIGHT OF THE VENT FLUEGELGEWICHT	MIN. 300KG MAX. 400KG

A - A

B

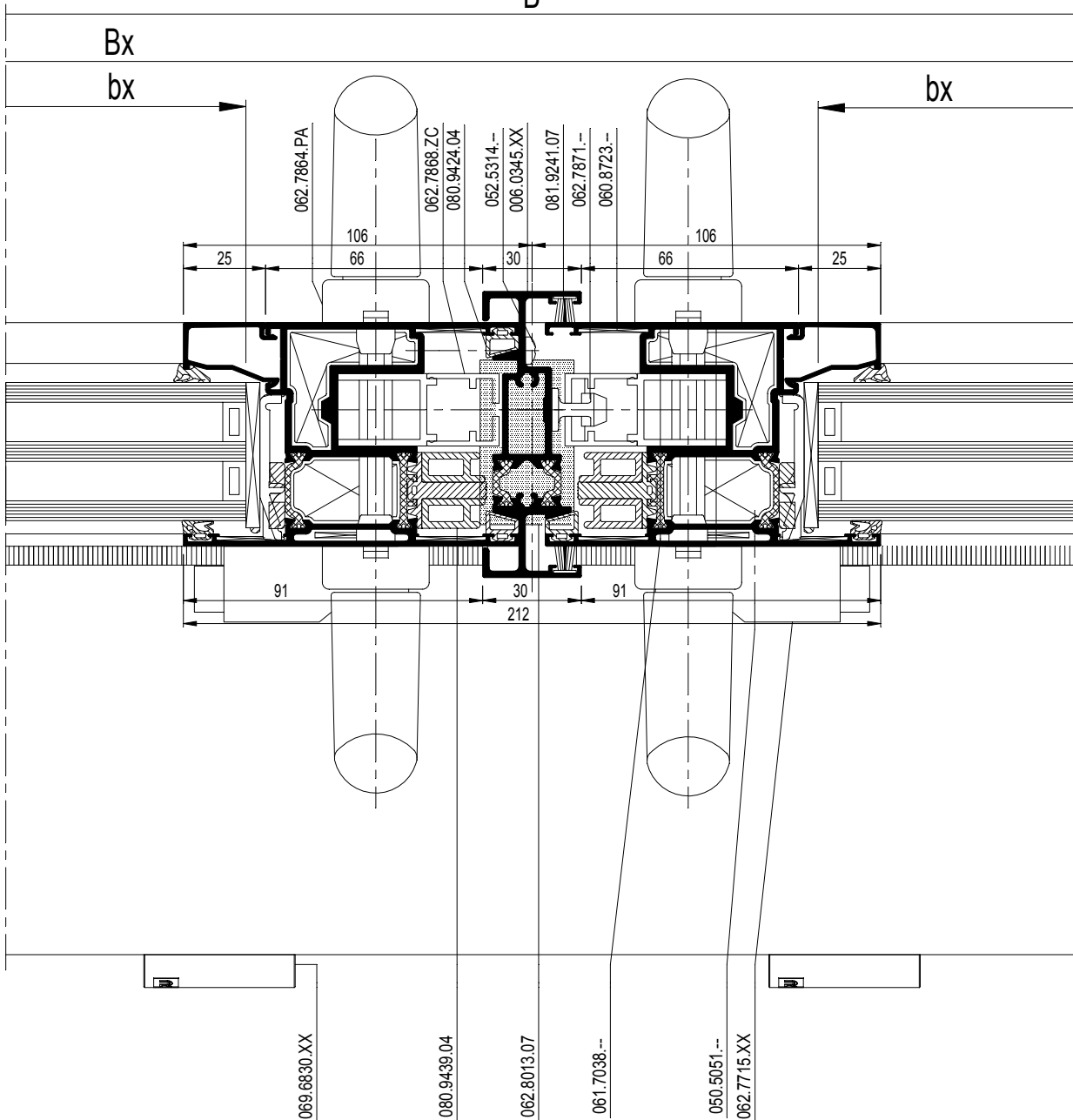

schaal - échelle
scale - Maßstab
1/2

D0083829

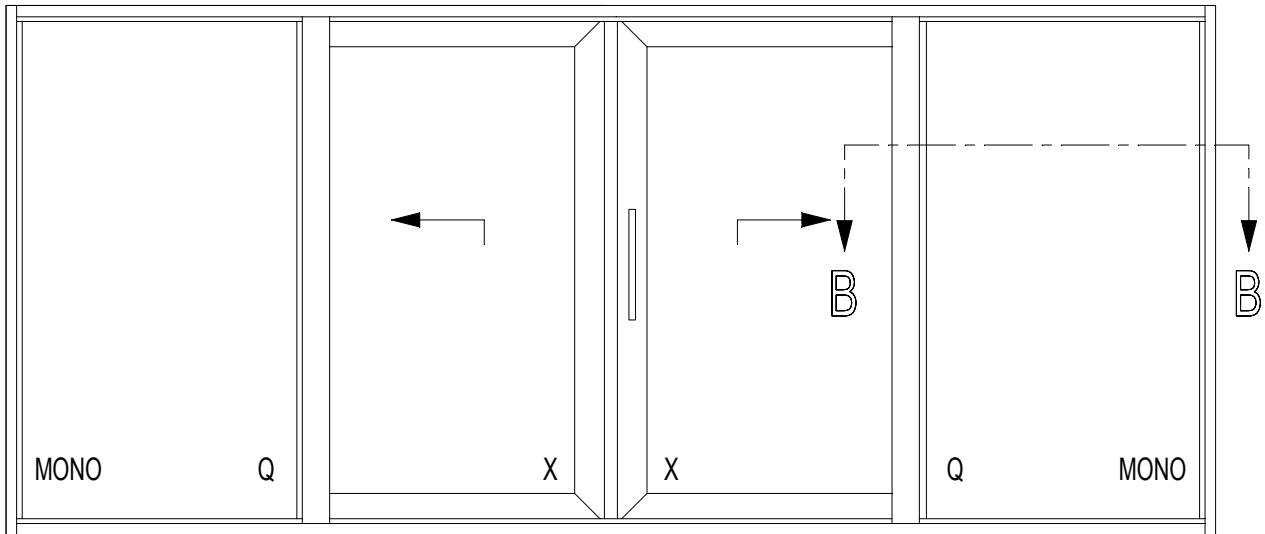

B - B

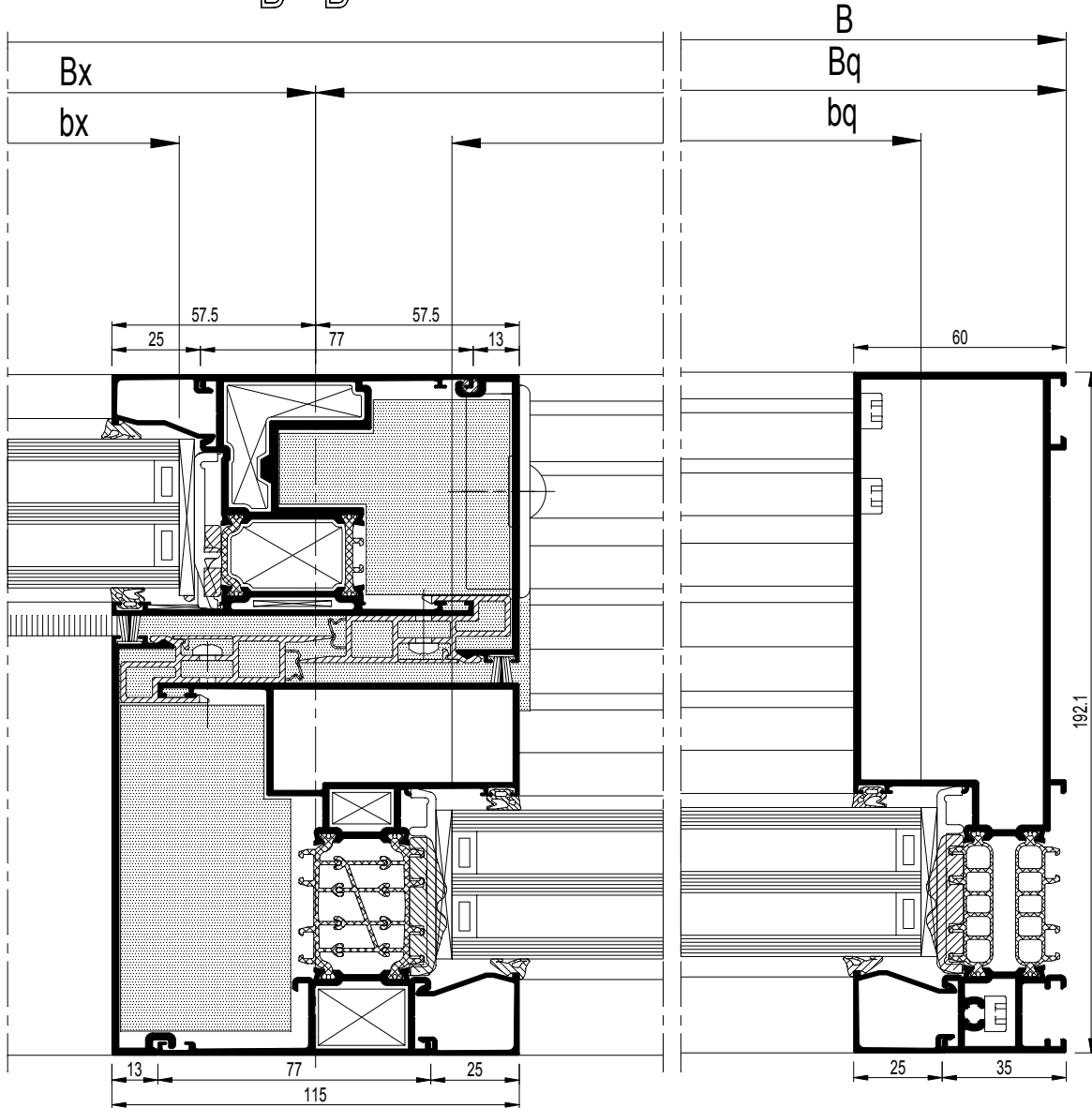

schaal - échelle
scale - Maßstab
1/2
D0083832



bx=BX-125.5
hx=H-275.5
bq=BQ-79.5
hq=H-87.5

				#	$\leftarrow L_m \rightarrow$	
	006.0321.XX			1	B-70	34.C...
	006.1301.04			1	B-120	34.C...
	006.0323.XX			1	B-70	34.C...
	006.1303.04			1	B-120	34.C...
	006.0327.XX			2	H	34.C...
	006.2340.XX			4	Bx-40.5	34.C...
				4	H-109.5	34.C...
	006.0350.XX			2	H-75.5	34.C...
	006.1342.XX			2	H-109.5	34.C...
	006.0351.XX			2	H-75.5	34.C...
	006.1341.04			4	H-109.5	34.C...
	006.0366.XX			2	Bx-115	34.C...
	103.0081.04			2	Bx-115	34.C...
	030.3608.XX			4	(Bx:2)-113.5	34.C...
				4	H-313.5	34.C...
	030.3611.XX			4	Bq-67.5	34.C...
				4	H-125.5	34.C...
	011.4631.--			1	B-120	34.C...
	006.0345.XX			1	H-109.5	34.C...
(A)	0M0.1505.XX			1	BX-622.5	34.C...
(B)	0M0.1505.XX			2	40	34.C...
				1	BX-1246.5	34.C...

(A)	VLEUGELGEWICHT POIDS DU VANTAIL WEIGHT OF THE VENT FLUEGELGEWICHT	MAX. 300KG
-----	--	------------

(B)	VLEUGELGEWICHT POIDS DU VANTAIL WEIGHT OF THE VENT FLUEGELGEWICHT	MIN. 300KG MAX. 400KG
-----	--	--------------------------

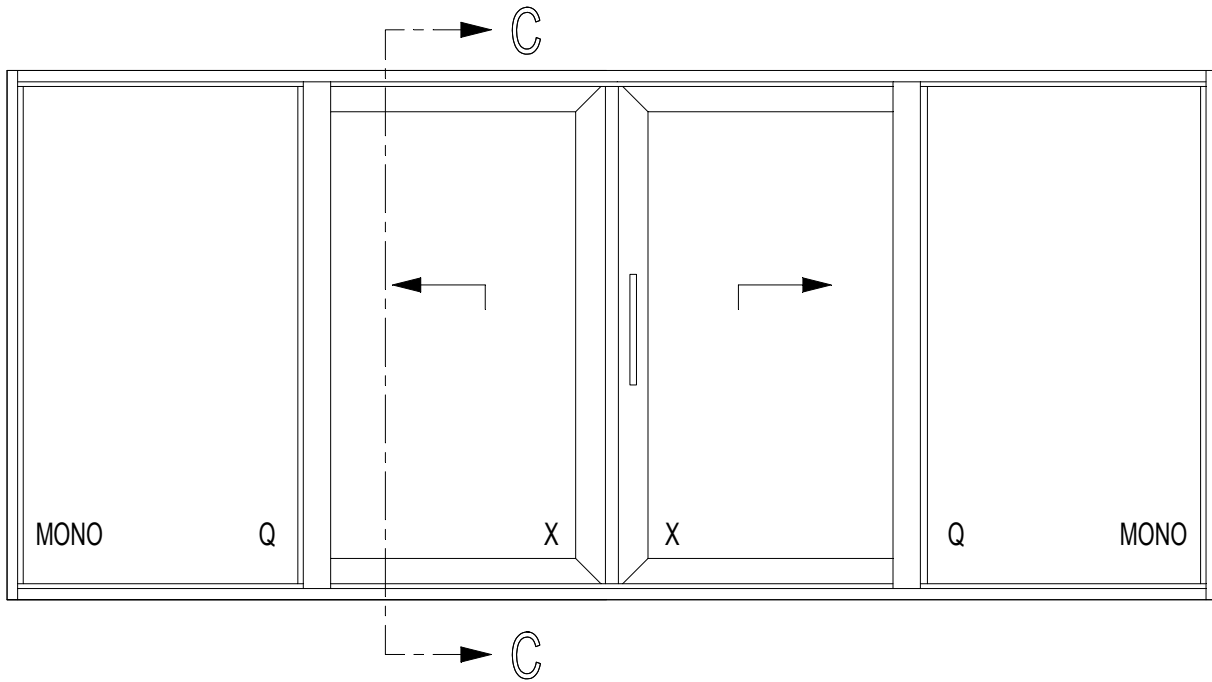

			#	
	052.5371.--		12	34.G...
	062.9393.04		2	34.G...
	068.7775.00		8	34.G...
	069.6569.04		8	34.G...
	068.7776.00		8	34.G...
	060.8723.--		16	34.G...
	060.8746.00		8	34.G...
	068.8731.00		4	34.G...
	068.8687.04		8	34.G...
	050.5153.--		8	34.G...
	068.8687.04		8	34.G...
	062.7894.--		2	34.G...
	052.8317.--		4	34.G...
	071.6554.XX		4	34.G...
(A)	062.7867.--		2	34.G...
(B)	062.7867.--		2	34.G...
	062.7903.--		2	34.G...
(*)	062.7902.ZC		2	34.G...
	062.7868.ZC		2	34.G...
	062.7864.PA		2	34.G...
	061.7038.--		2	34.G...
(A)	062.7715.XX		2	34.G...
	050.5051.--		2	34.G...
(B)	062.7715.XX		4	34.G...
	057.5721.--		4	34.G...
	050.5052.--		4	34.G...
	062.7717.04		2	34.G...
	062.8045.04		4	34.G...
	062.7871.--		1	34.G...

			#	
	062.8011.04		2	34.G...
	062.8036.04		2	34.G...
	052.5317.--		4	34.G...
	062.8013.07		1	34.G...
	052.5311.--		4	34.G...
	052.5317.--		4	34.G...
	052.5310.--		4xH(3/m)	34.G...
	052.5300.--		2xBx(3/m)	34.G...
	052.5314.--		H(3/m)	34.G...
(A)	069.8704.01		16(-250kg)	34.G...
(A)	069.8704.01		12(+250kg)	34.G...
	069.8724.04		4	34.G...
(B)	069.8704.01		12	34.G...
	069.8724.04		8	34.G...
	069.8748.01		16	34.G...
	069.8422.04		(2xBx)3/m	34.G...
	069.6830.04		min. 2	34.G...
	069.6747.04		4	34.G...
	080.9124.SY		(2xB)+(8xH)	34.G...
	080.9114.SY		(2xb)+(8xH)	34.G...
	080.9381.04		(2xB)+(2xH)	34.G...
	080.9424.04		(8xBx)+(3xH)	34.G...
	081.9241.07		(2xBx)+(6xH)	34.G...
	080.9439.04		(2xBx)+(2xH)	34.G...
	080.9625.07		(4xBx)+(4xH)	34.G...
	080.9630.07		(4xBq)+(4xH)	34.G...
	080.9629.07		B	34.G...
	084.9410.01		2	34.G...
	084.9411.01		2	34.G...

(*) Afankelijk van de hoogte
 Dépend de l'hauteur
 Depending of the height
 Von der Höhe abhängig

C - C

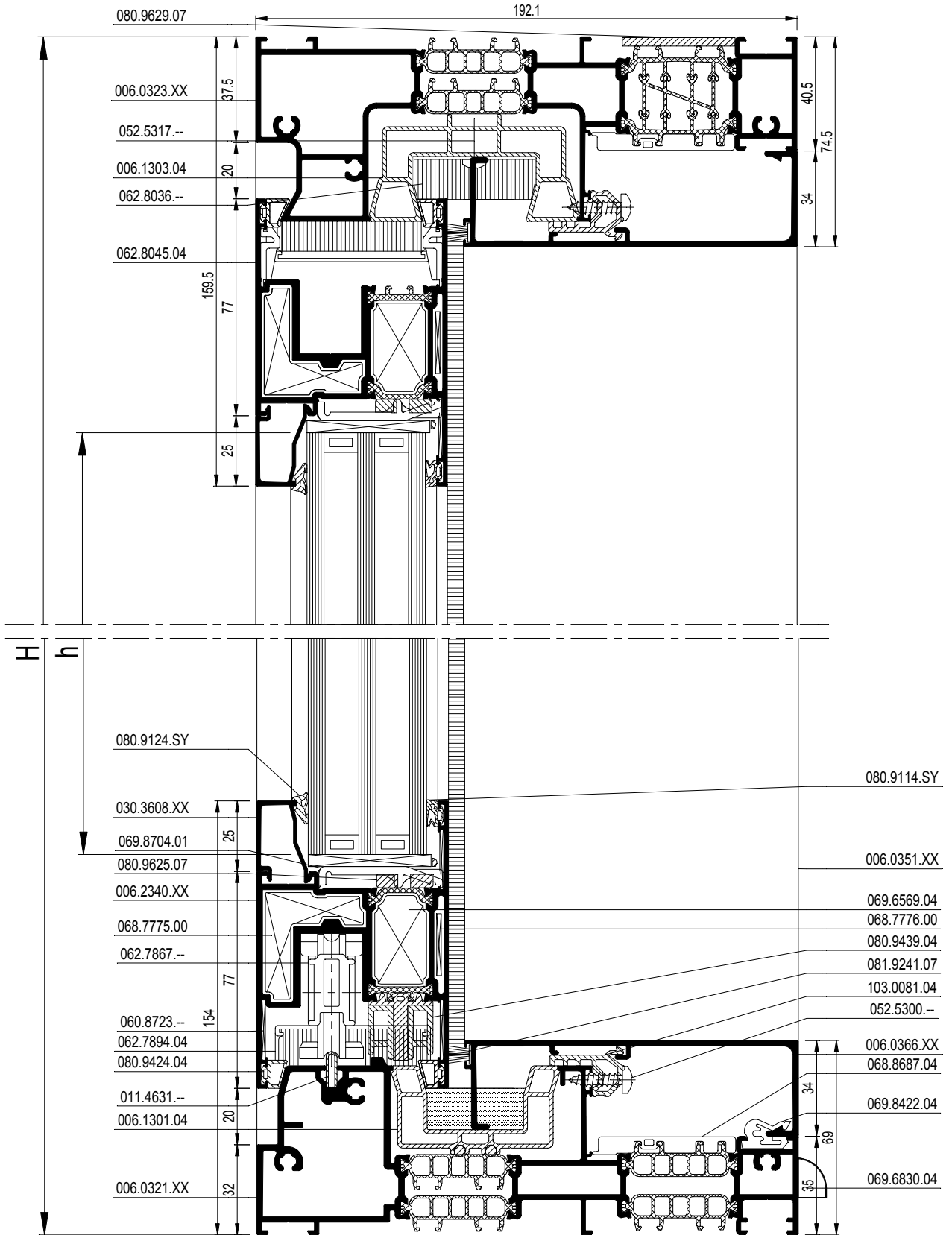

(A)

VLEUGELGEWICHT POIDS DU VANTAIL WEIGHT OF THE VENT FLUEGELGEWICHT	MAX. 300KG
--	------------

(B)

VLEUGELGEWICHT POIDS DU VANTAIL WEIGHT OF THE VENT FLUEGELGEWICHT	MIN. 300KG MAX. 400KG
--	--------------------------

schaal - échelle
 scale - Maßstab
 1/2

D0083834

VLEUGELGEWICHT POIDS DU VANTAIL WEIGHT OF THE VENT FLUEGELGEWICHT	MAX. 250KG
--	------------

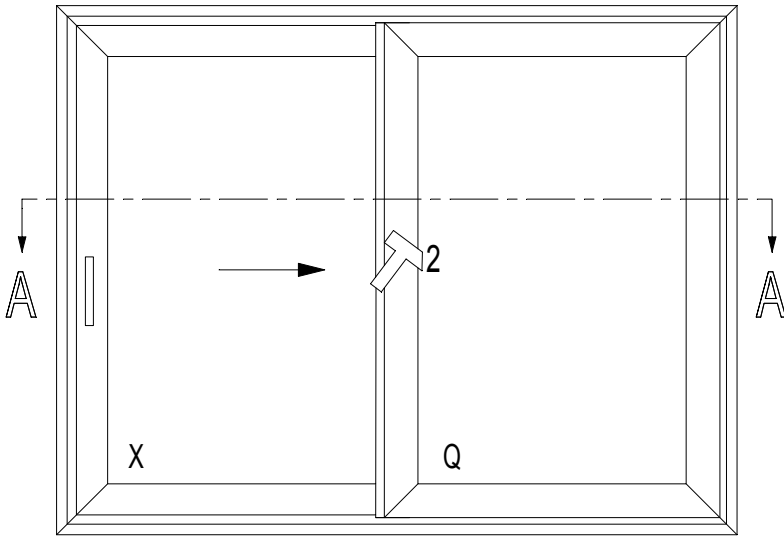

A - A

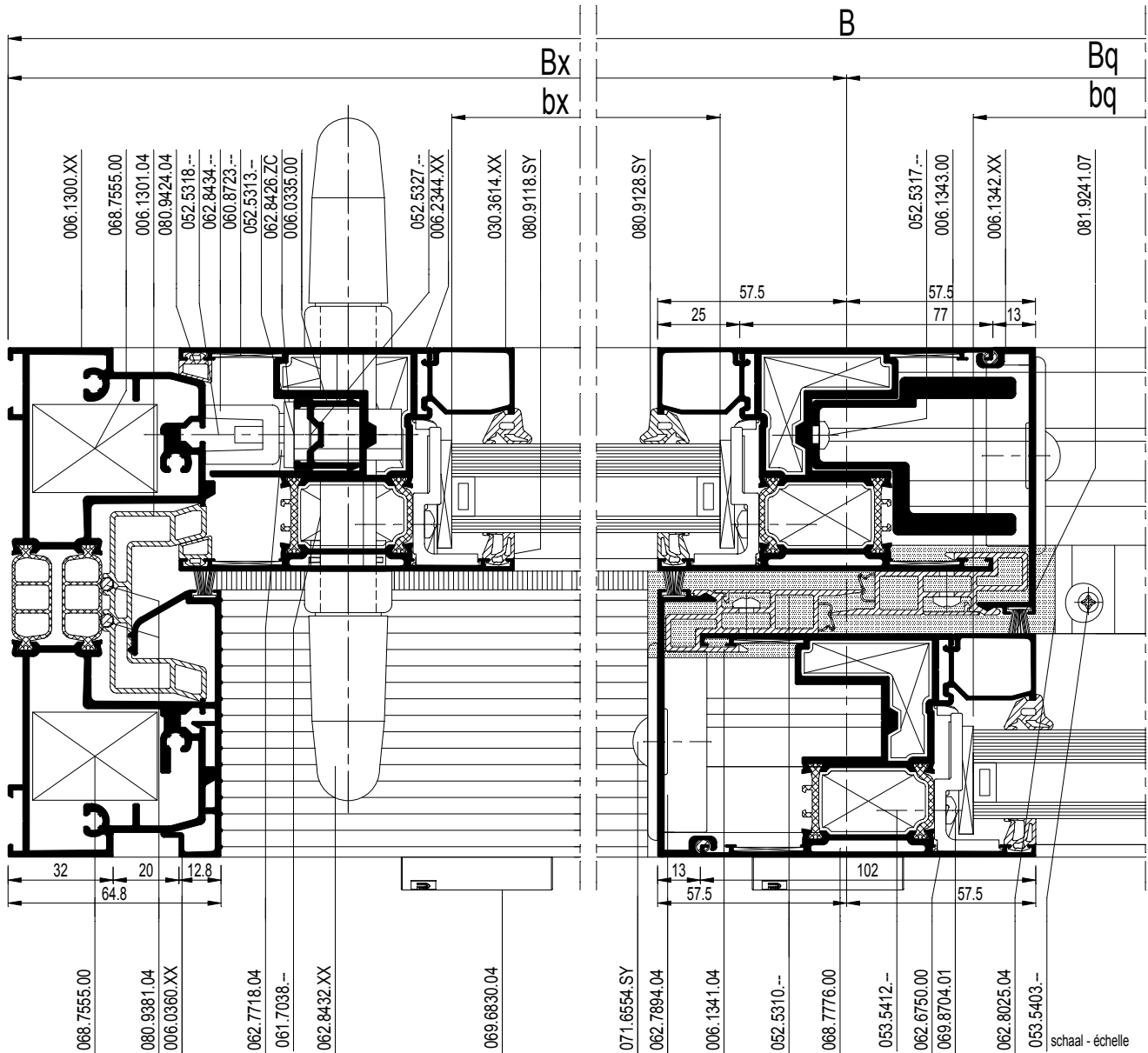

D0084701

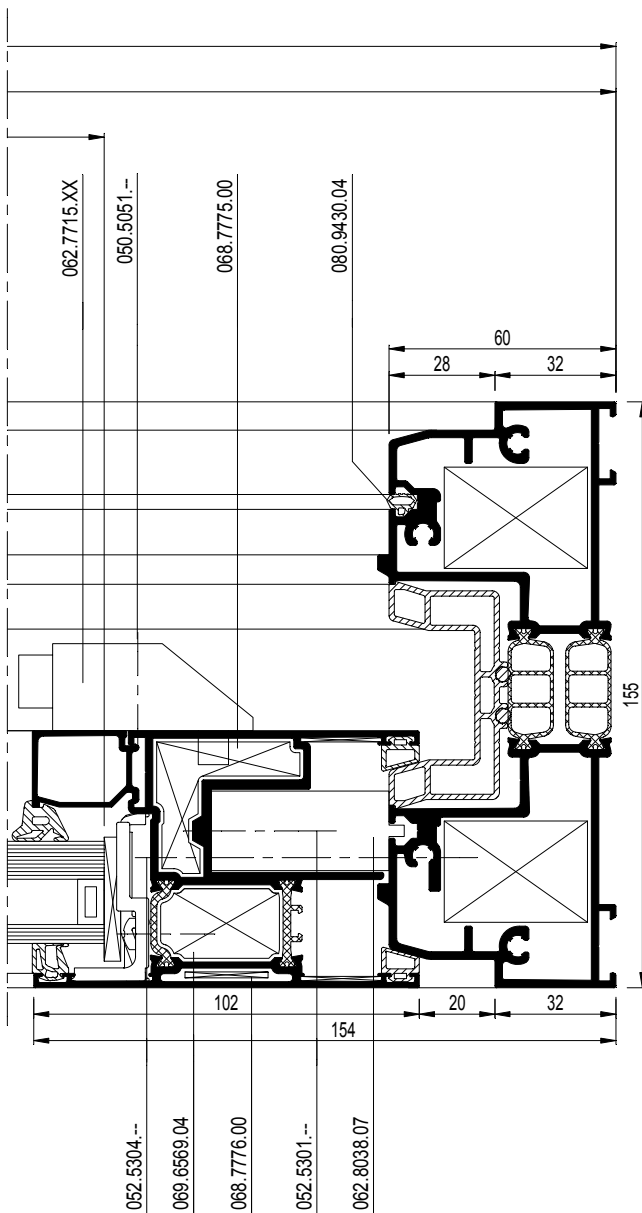

schaal - échelle
 Maßstab - scale
 1/2

D0084701

CP 155-AP

2-RAIL XQ INBRAAKWEREND
2-RAIL XQ PROTECTION ANTI-VOL
2-RAIL XQ BURGLAR PROTECTION
2-RAIL XQ EINBRUCHHEMMEND

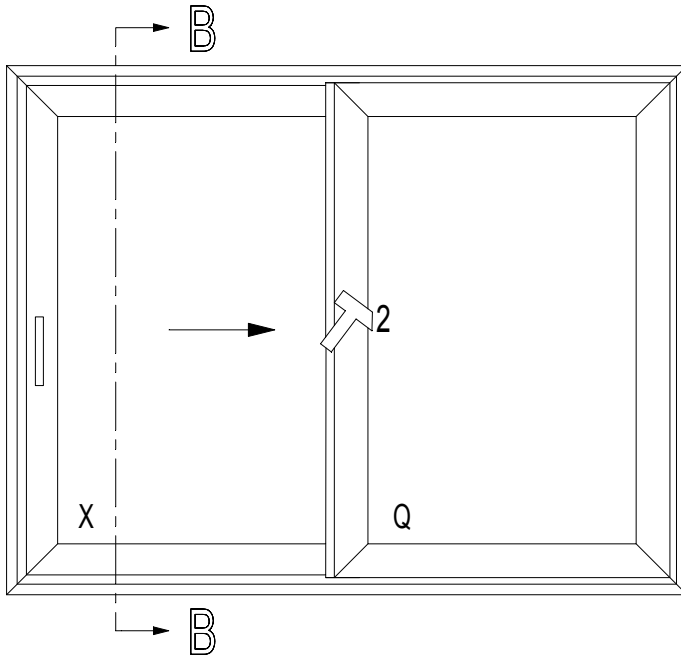

VLEUGELGEWICHT POIDS DU VANTAIL WEIGHT OF THE VENT FLUEGELGEWICHT	MAX. 250KG
--	------------

B - B

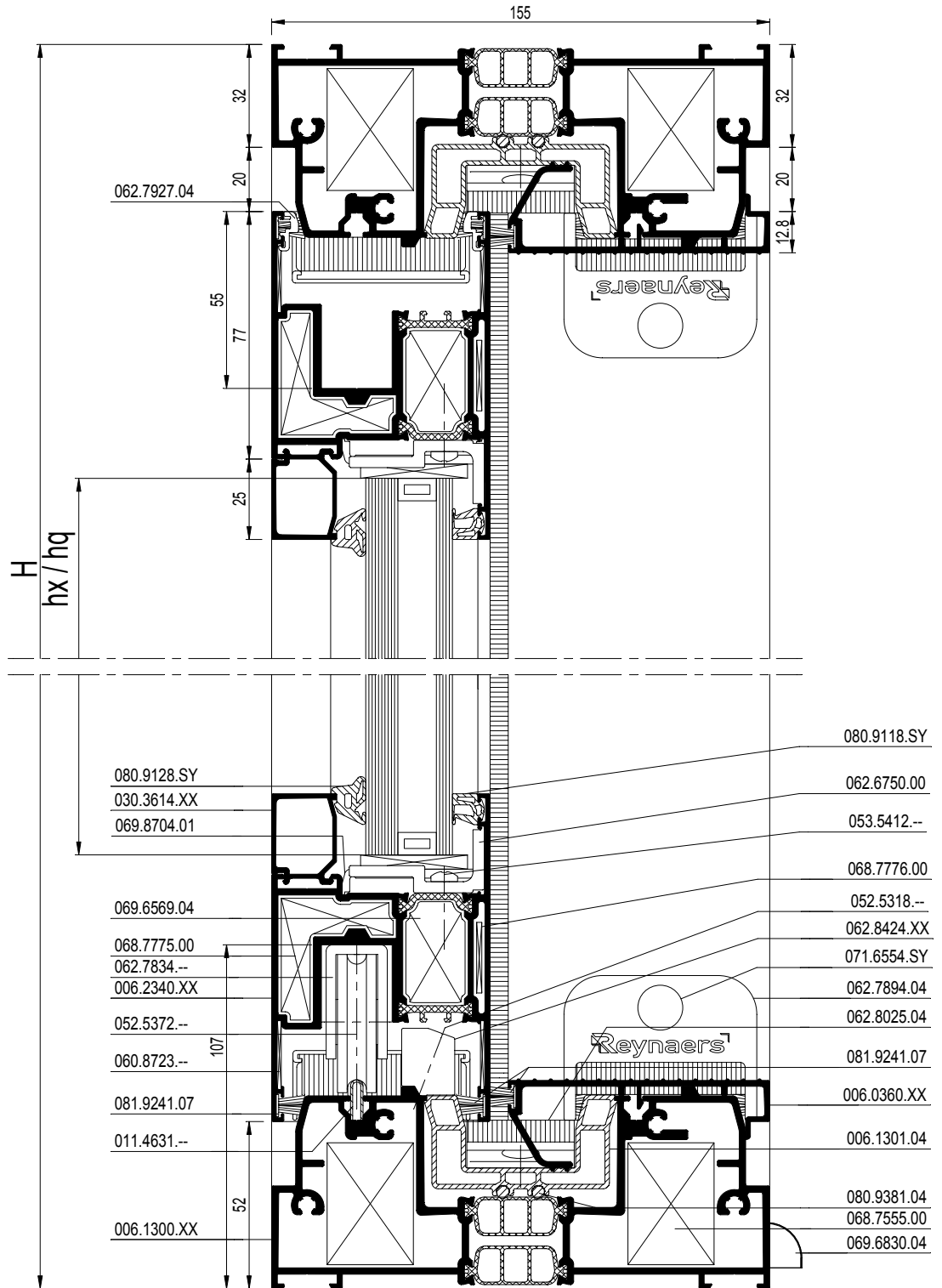

schaal - échelle
 Maßstab - scale
 1/2

D0084702

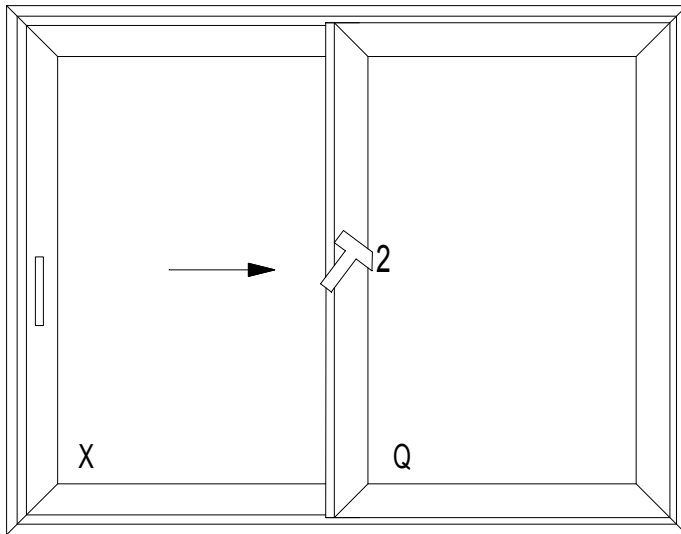

VLEUGELGEWICHT POIDS DU VANTAIL WEIGHT OF THE VENT FLUEGELGEWICHT	MAX. 250KG
--	------------

				#	$\leftarrow L_m \rightarrow$	
006.1300.XX				2	B	34.C. ...
006.1301.04				2	H	
011.4631.--				1	B-116	34.C. ...
006.2340.XX				1	Bx-7.5	34.C. ...
				1	Bq-7.5	
				2	H-104	
006.1342.XX				2	H-104	34.C. ...
006.1341.04				2	H-104	34.C. ...
006.1343.00				1	H-162	34.C. ...
006.0335.00				1	280MM	34.C. ...
					(062.8425.ZC) OF-OVER-OVER	
				1	H-214 (062.8426.ZC)	
006.0360.XX				1	Bx-97	34.C. ...
				1	Bq-97	
				1	H-75.6	
030.3614.XX				2	Bx-161.5	34.C. ...
				2	Bq-161.5	
				4	H-308	

				#	$\leftarrow L_m \rightarrow$	
006.2344.XX				1	Bx-7.5	34.C. ...
				1	Bq-7.5	
				2	H-104	

030.3650.XX				2	Bx-161.5	34.C. ...
				2	Bq-161.5	
				4	H-308	

			#	
bx = Bx-173.5	068.7555.00		8	34.G. ...
hx = H-270	068.7775.00		8	34.G. ...
bq = Bq-173.5	069.6569.04		8	34.G. ...
hq = H-270	068.7776.00		8	34.G. ...
	060.8723.--		24	34.G. ...
	062.7894.04		2	34.G. ...
	052.5317.--		4	34.G. ...
	071.6554.SY		4	34.G. ...
	062.7927.04		min. 8	34.G. ...
	062.8426.ZC		1	34.G....
	052.5313.--		13	34.G....
	062.8440.--		1	34.G....
	052.5318.--		12	34.G....
	052.5327.--		6	34.G....
	061.7130.PA		1	34.G. ...
	050.5083.--		3	34.G. ...
	061.7140.PA		1	34.G. ...
	061.7098.--		1	34.G. ...
	061.7038.--		1	34.G. ...
	062.6750.00		16	34.G. ...
	053.5412.--		48	34.G. ...
	062.8424.XX		1	34.G. ...
	052.5318.--		4	34.G. ...
	062.7718.04		1	34.G. ...
	062.7715.XX		1	34.G. ...
	050.5051.--		1	34.G. ...
	062.7834.--		2	34.G. ...
	052.5372.--		4	34.G. ...
	062.8038.07		6	34.G. ...
	052.5301.--		6	34.G. ...
	052.5304.--		6	34.G. ...
	062.8025.04		1	34.G. ...
	053.5403.--		4	34.G. ...
	052.5310.--		2xH (3/m)	34.G. ...
	052.5317.--		H (3/m)	34.G. ...
	069.8704.01		16	34.G. ...
	062.6857.04		1	34.G. ...
	069.6830.04		min. 2	34.G. ...
	080.9424.04		4xH	34.G. ...
	080.9128.SY		(2xB)+(4xH)	34.G. ...
	080.9118.SY		(2xB)+(4xH)	34.G. ...
	080.9381.04		(4xB)+(4xH)	34.G. ...
	081.9241.07		(5xB)+(3xH)	34.G. ...
	080.9430.04		1xH	34.G. ...

+ AP

062.8432.XX		1	34.G. ...
062.8433.--		1	34.G. ...

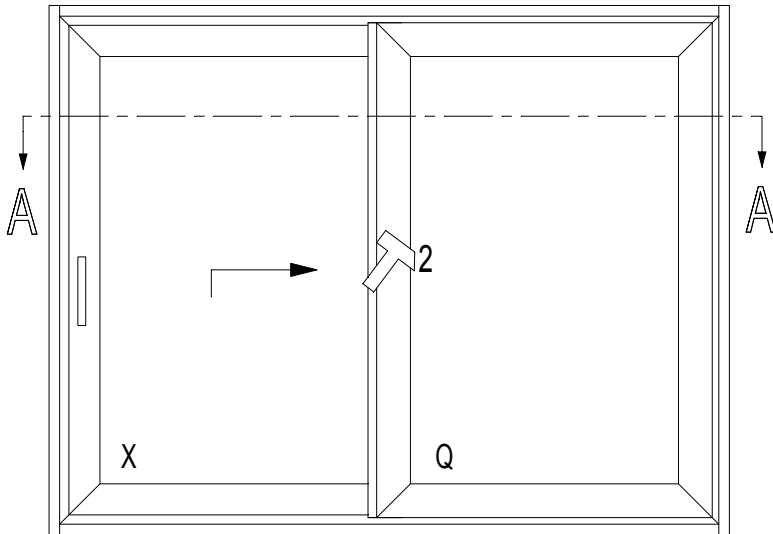

A - A

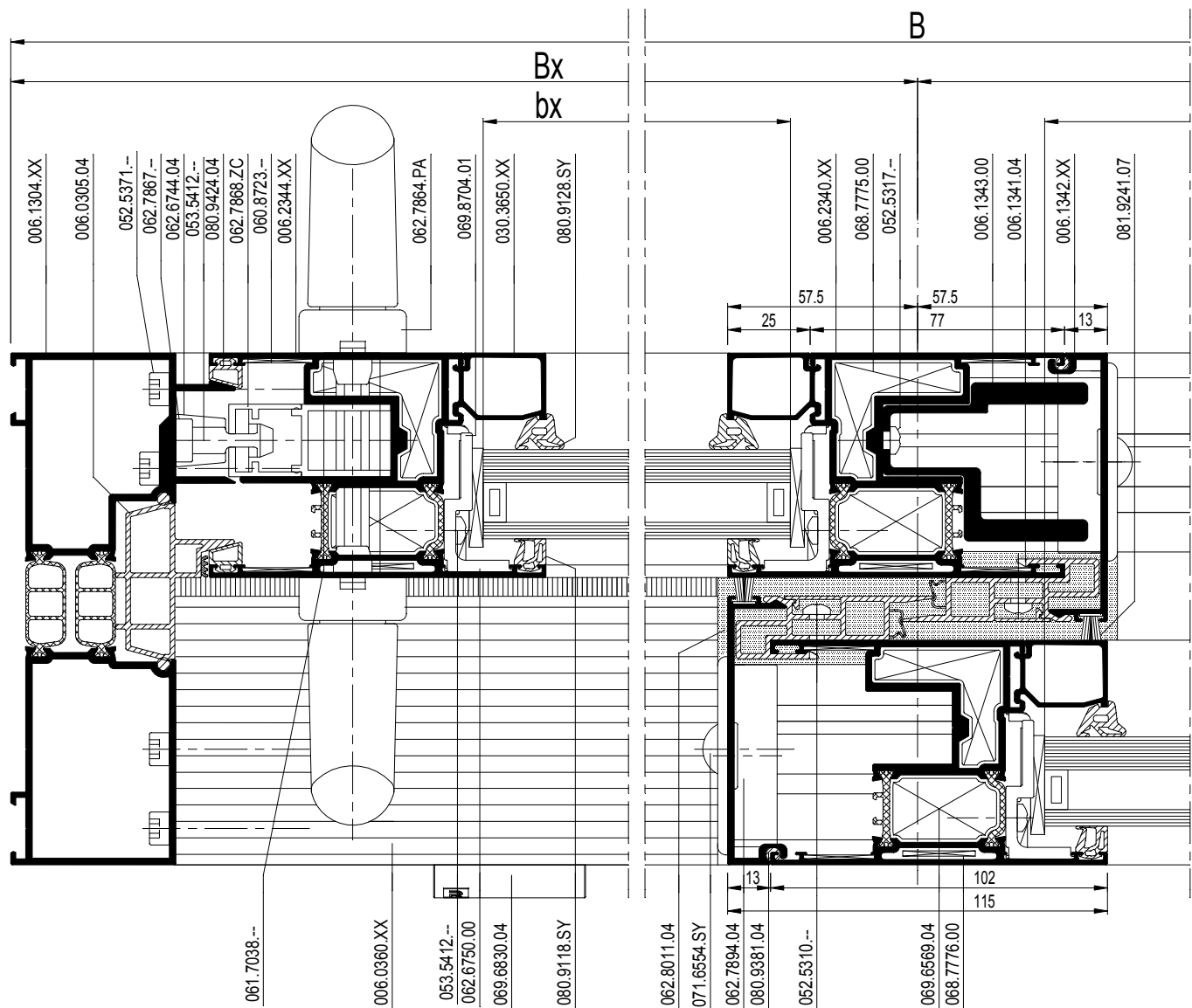

D0090900

(A)	VLEUGELGEWICHT POIDS DU VANTAIL WEIGHT OF THE VENT FLUEGELGEWICHT	MAX. 300KG
(B)	VLEUGELGEWICHT POIDS DU VANTAIL WEIGHT OF THE VENT FLUEGELGEWICHT	MIN. 300KG MAX. 400KG
	HOOGTE HAUTEUR HEIGHT HOEHE	MIN. 1780 MM

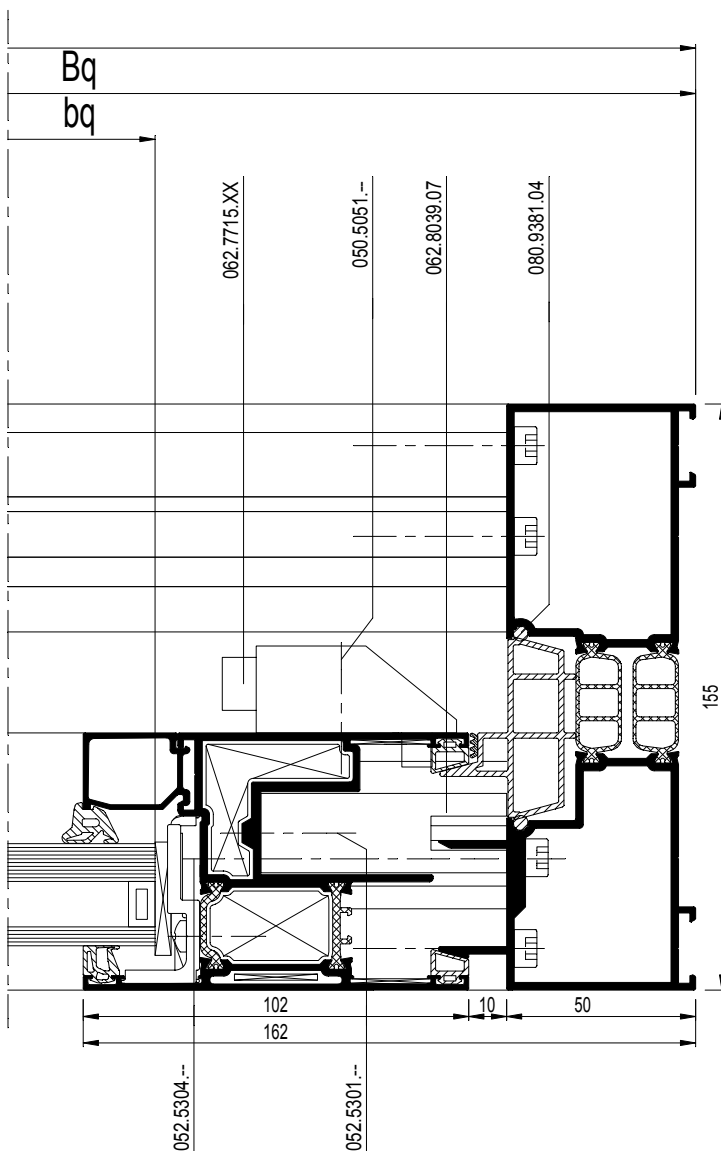

CP 155-LS/AP

2-RAIL XQ
2-RAIL XQ
2-RAIL XQ
2-RAIL XQ

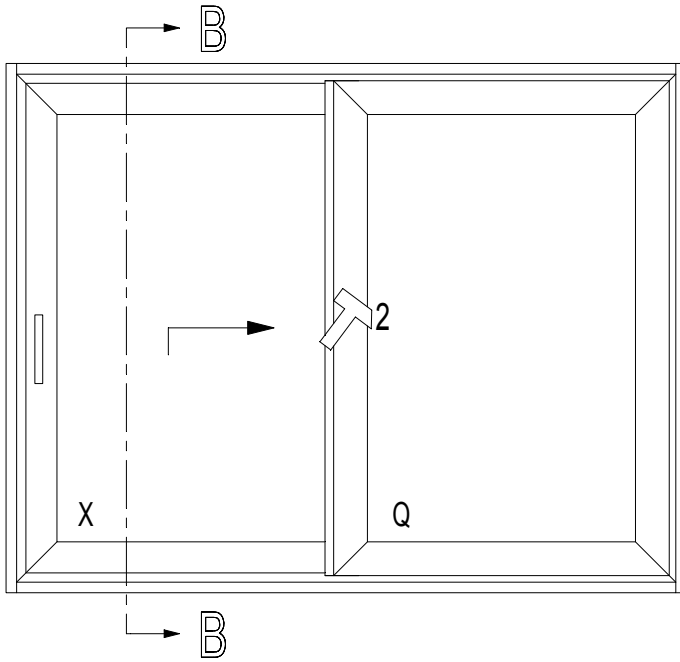

(A)	VLEUGELGEWICHT POIDS DU VANTAIL WEIGHT OF THE VENT FLUEGELGEWICHT	MAX. 300KG
(B)	VLEUGELGEWICHT POIDS DU VANTAIL WEIGHT OF THE VENT FLUEGELGEWICHT	MIN. 300KG MAX. 400KG
	HOOGTE HAUTEUR HEIGHT HOEHE	MIN. 1780 MM

schaal - échelle
scale - Maßstab
1/2

D00090906

B - B

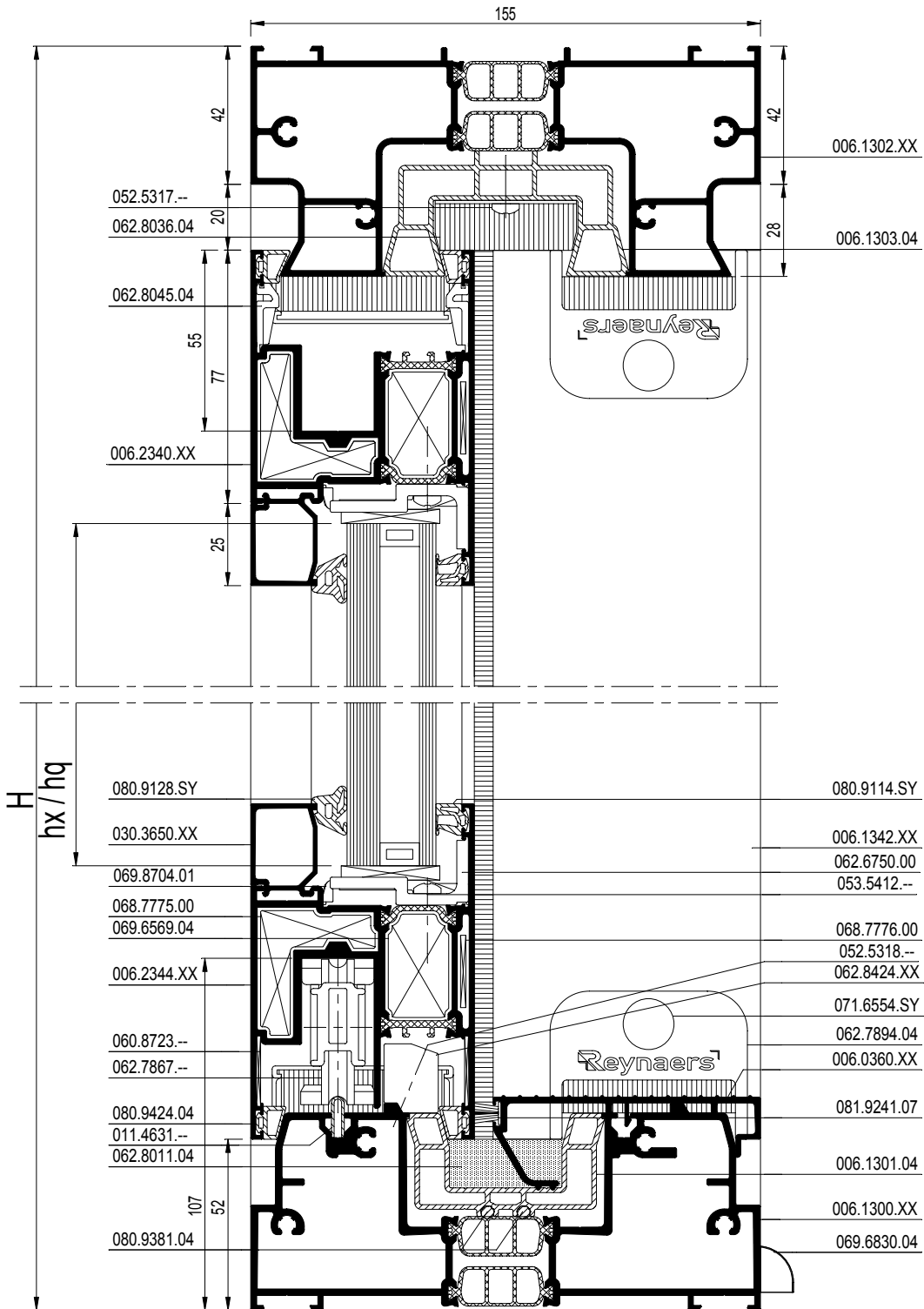

schaal - échelle
 scale - Maßstab
 1/2

D00090906

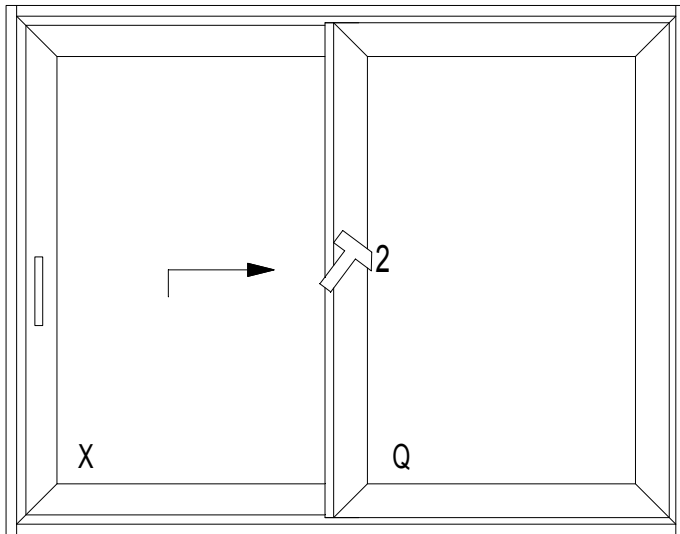

HOOGTE HAUTEUR HEIGHT HOEHE	MIN. 1780 MM
--------------------------------------	--------------

(A) VLEUGELGEWICHT POIDS DU VANTAIL WEIGHT OF THE VENT FLUEGELGEWICHT	MAX. 300KG
--	------------

(B) VLEUGELGEWICHT POIDS DU VANTAIL WEIGHT OF THE VENT FLUEGELGEWICHT	MIN. 300KG MAX. 400KG
--	--------------------------

			#	$\leftarrow L_m$	
006.1300.XX 006.1301.04			1	B-100	34.C. ...
006.1302.XX 006.1303.04			1	B-100	34.C. ...
008.1306.XX			2	H	34.C. ...
006.0305.04			2	H-150	34.C. ...
011.4631.--			1	B-100	34.C. ...
006.2340.XX			1	Bx-15.5	34.C. ...
			1	Bq-15.5	
			2	H-114	
006.1342.XX			2	H-114	34.C. ...
006.1341.04			2	H-114	34.C. ...
006.1343.00			1	H-172	34.C. ...
030.3614.XX			2	Bx-169.5	34.C. ...
			2	Bq-169.5	
			4	H-318	
006.0360.XX			1	Bx-110.5	34.C. ...
(A) 0M0.1505.XX			1	Bx-678.5	34.C. ...
(B) 0M0.1505.XX			2	40	34.C. ...
			1	Bx-1302.5	34.C. ...

006.1304.XX			2	H	34.C. ...
-------------	--	--	---	---	-----------

006.2344.XX			1	Bx-15.5	34.C. ...
			1	Bq-15.5	
			2	H-114	

030.3650.XX			2	Bx-161.5	34.C. ...
			2	Bq-161.5	
			4	H-308	

		#	
bx = Bx-181.5			
hx = H-280			
bq = Bq-181.5			
hq = H-280			

	#	
052.5371.--	16	34.G.
068.7775.00	8	34.G.
069.6569.04	8	34.G.
068.7776.00	8	34.G.
060.8723.--	24	34.G.
062.7894.04	2	34.G.
052.5317.--	4	34.G.
071.6554.SY	4	34.G.
062.8045.04	2	34.G.
(*) 062.7902.ZC <small>OF-OU-OR-ODER</small>	1	34.G.
062.7868.ZC	1	34.G.
062.6744.04	2	34.G.
053.5412.--	2	34.G.
062.7864.PA	1	34.G.
061.7038.--	1	34.G.
062.6750.00	16	34.G.
053.5412.--	48	34.G.
062.8424.XX	1	34.G.
052.5318.--	4	34.G.
(A) 062.7715.XX	1	34.G.
050.5051.--	1	34.G.
(B) 062.7715.XX	2	34.G.
050.5051.--	2	34.G.
057.5721.--	2	34.G.
(A) 062.7867.--	1	34.G.
062.7867.--	1	34.G.
(B) 062.7903.--	1	34.G.
062.8038.07	3	34.G.
052.5301.--	3	34.G.
052.5304.--	3	34.G.
062.8039.07	3	34.G.
052.5301.--	3	34.G.
052.5304.--	3	34.G.
062.8011.04	1	34.G.
062.8036.04	1	34.G.
052.5317.--	2	34.G.

	#	
(**) 062.9372.04 <small>OF-OU-OR-ODER</small>	2	34.G.
062.9375.04	2	34.G.
062.9396.04	2	34.G.
052.5310.--	2xH (3/m)	34.G.
052.5317.--	H (3/m)	34.G.
(A) 069.8704.01	16 (-250KG)	34.G.
(A) 069.8704.01	12 (+250KG)	34.G.
069.8724.04	4	34.G.
(B) 069.8704.01	12	34.G.
069.8724.04	8	34.G.
069.6830.04	min. 2	34.G.
062.6857.04	1	34.G.
080.9124.SY	(2xB)+(4xH)	34.G.
080.9114.SY	(2xB)+(4xH)	34.G.
080.9381.04	(2xB)+(6xH)	34.G.
080.9424.04	(4xB)+(4xH)	34.G.
081.9241.07	(2xH)+(Bx)	34.G.

VARIANT HI

080.9439.04		(1xB)+(3xH)	34.G.
080.9625.07		(2xB)+(4xH)	34.G.

(*) Afhankelijk van de hoogte
Dépend de l'hauteur
Dependent of the height
Von der Höhe abhängig

(**) Afhankelijk van de positie van de primaire vleugel
Dépend de la position de ouvrante principale
depending on the position of the primary vent
abhängig von der Position des primären Fluegel

CP 155-LS/AP

2-RAIL QXXQ
2-RAIL QXXQ
2-RAIL QXXQ
2-RAIL QXXQ



F



Montagetekeningen
Fabrication et montage
Assembly drawings
Montagezeichnungen

CP 155

ONTWATERING TYPE XQ XO XQX
DRAINAGE TYPE XQ XO XQX
DRAINAGE TYPE XQ XO XQX
ENTWAESSERUNG TYP XQ XO XQX



TYPE XQ
 TYPE XO

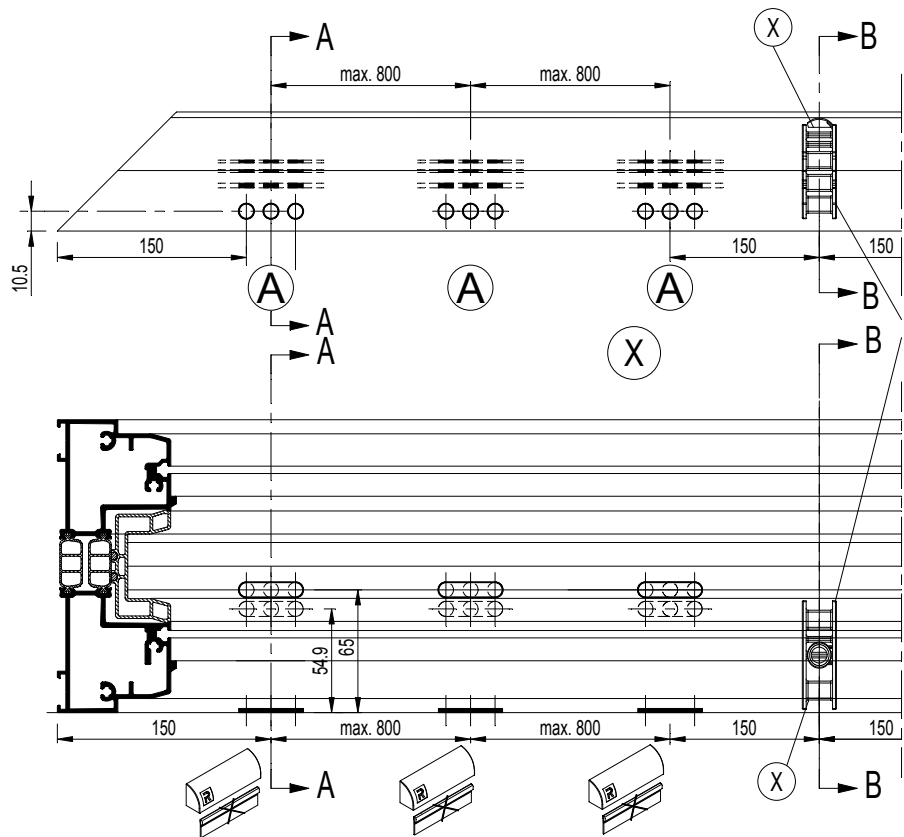

TYPE XQX

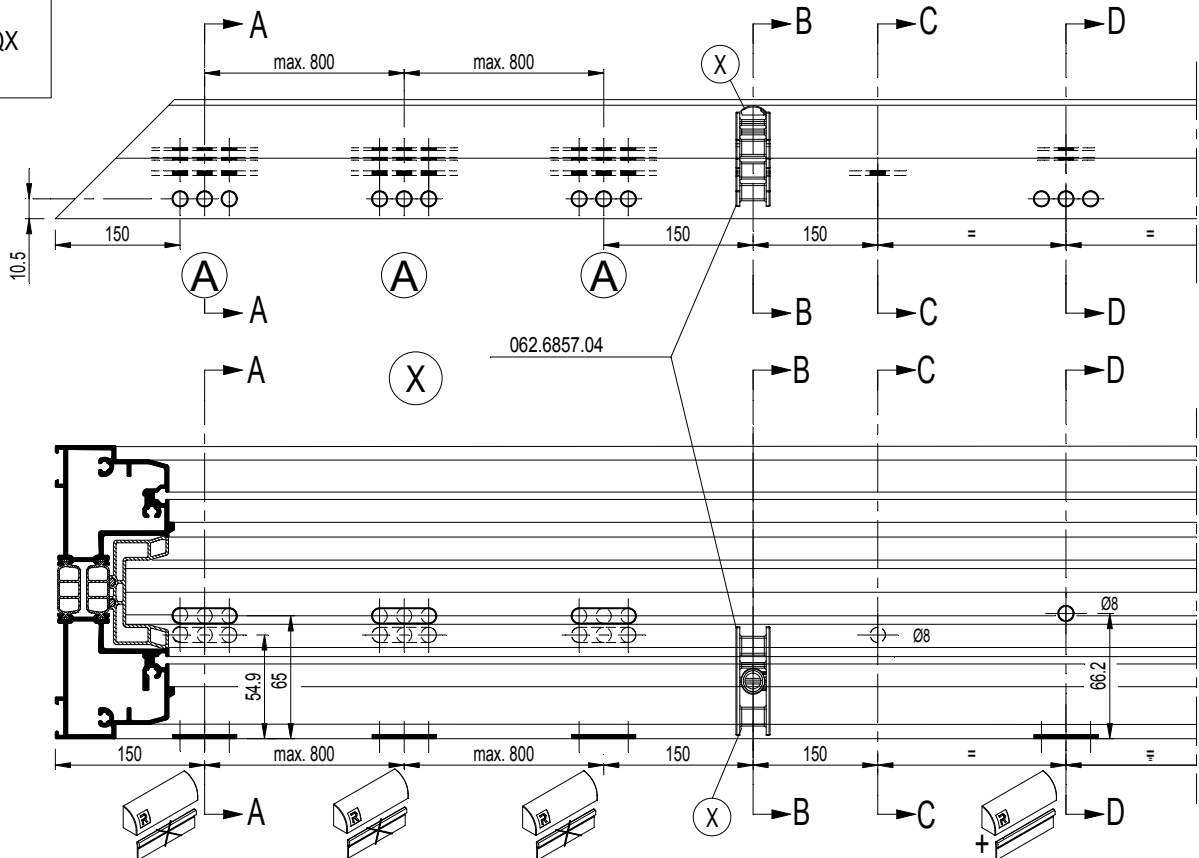

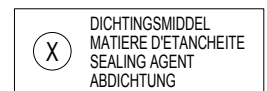
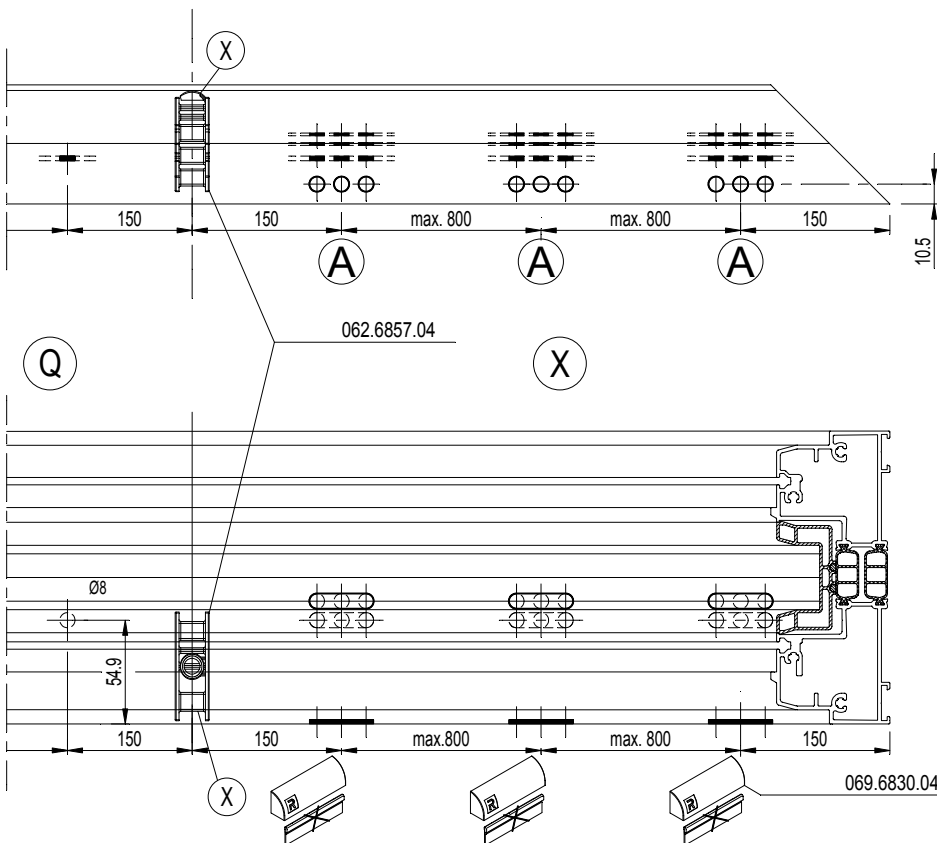
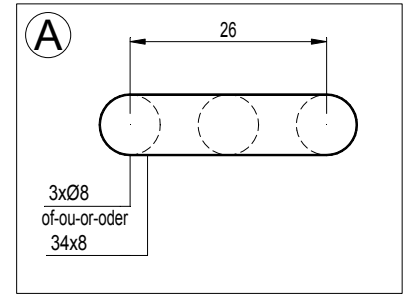
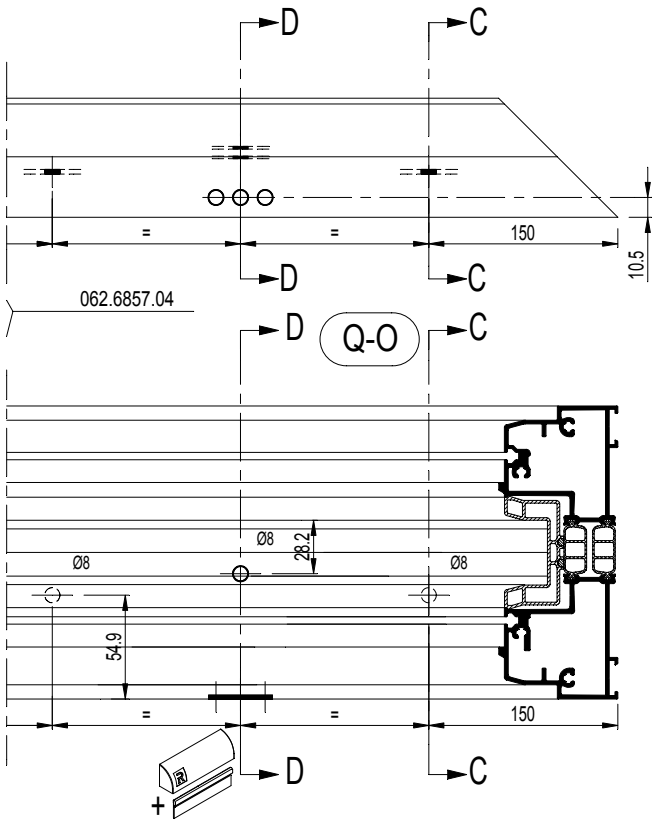

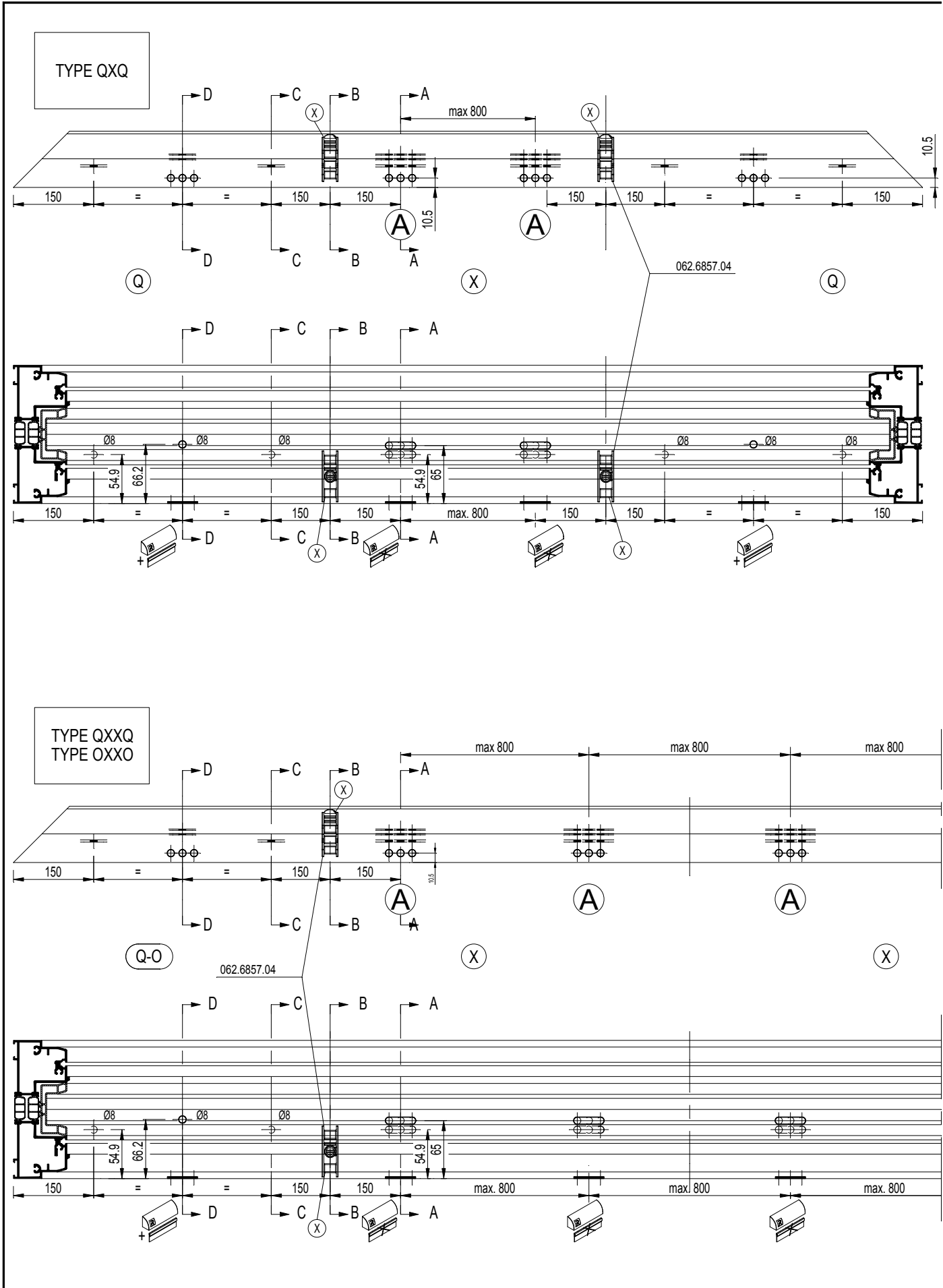

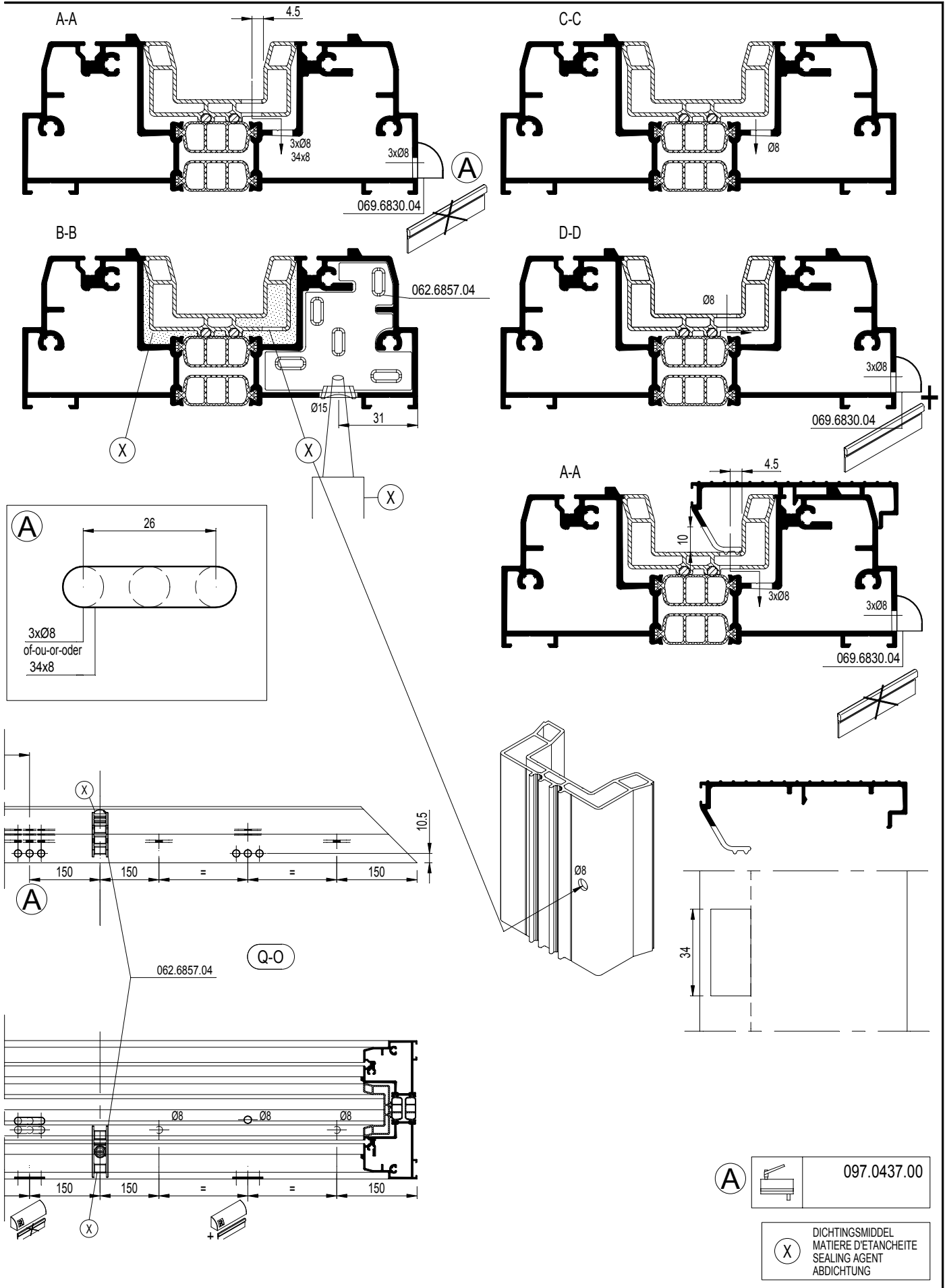

TYPE XQ
 TYPE XX

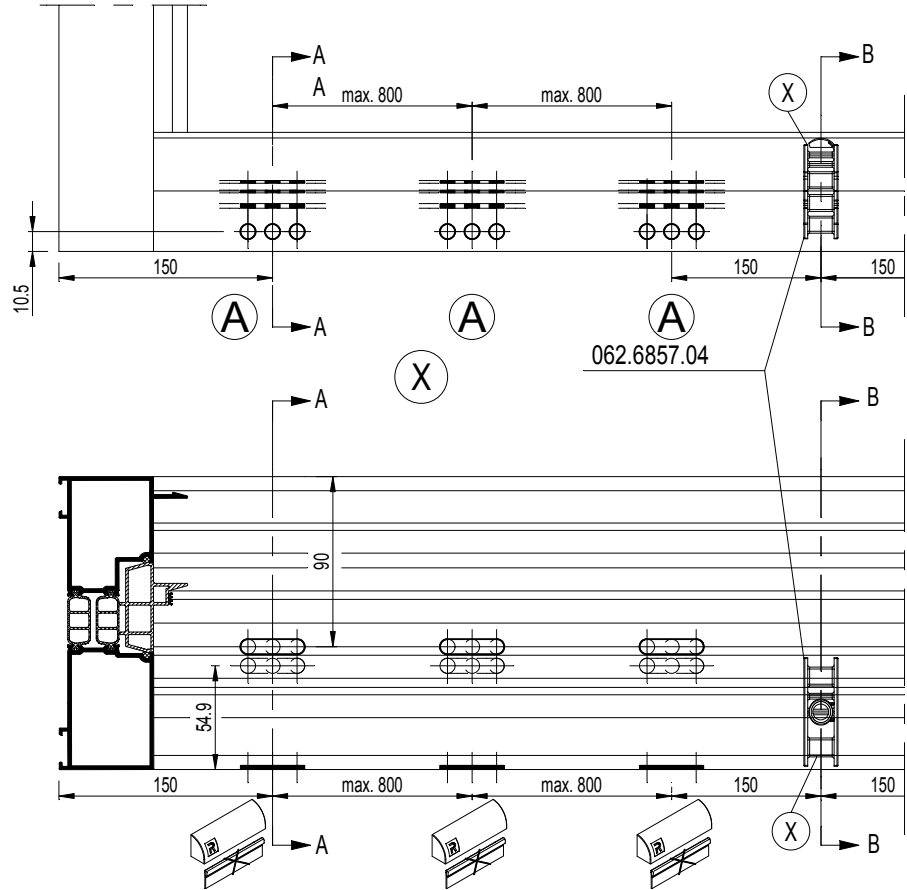

TYPE XQX

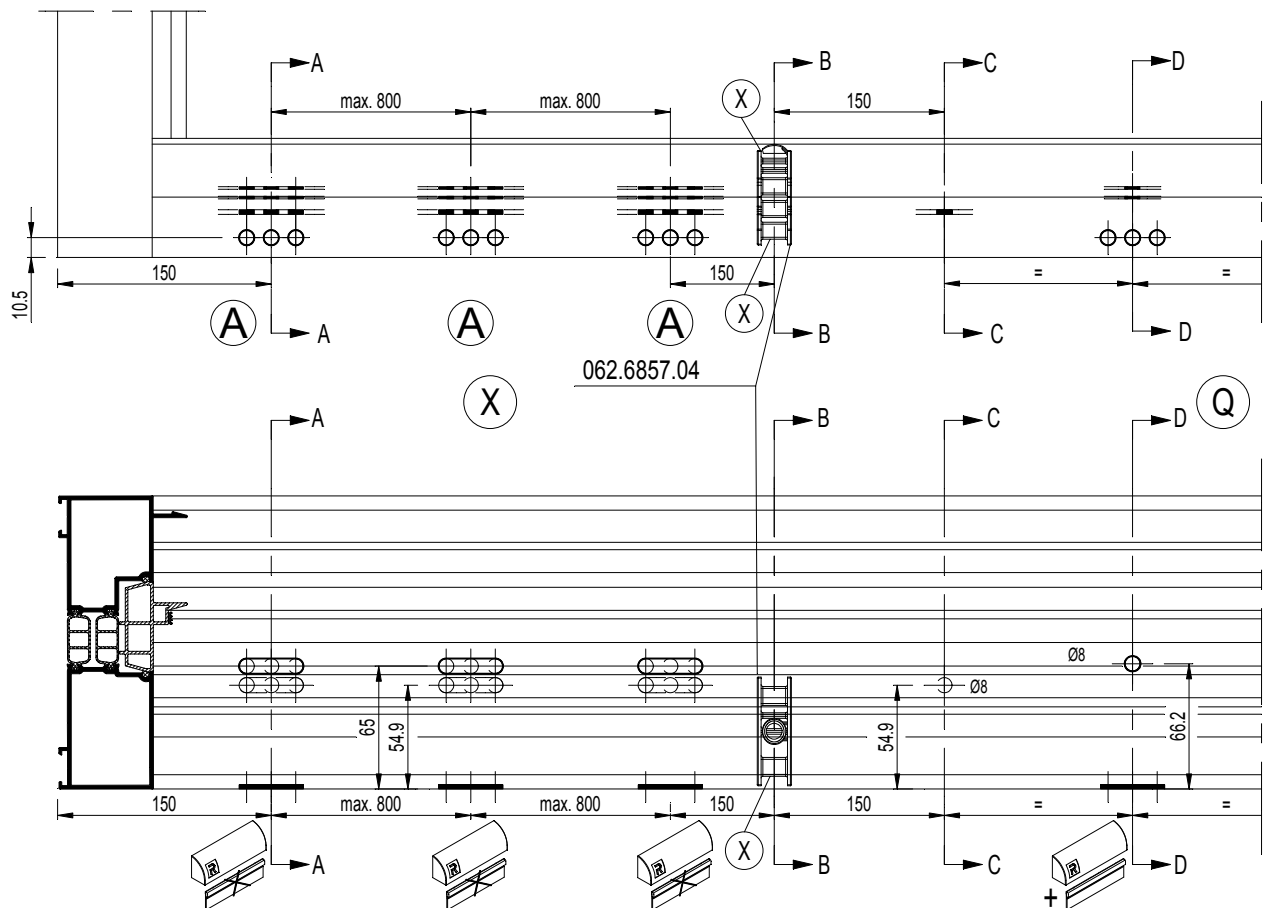

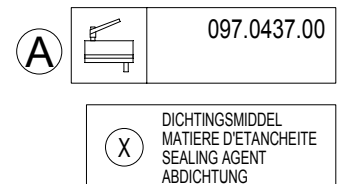
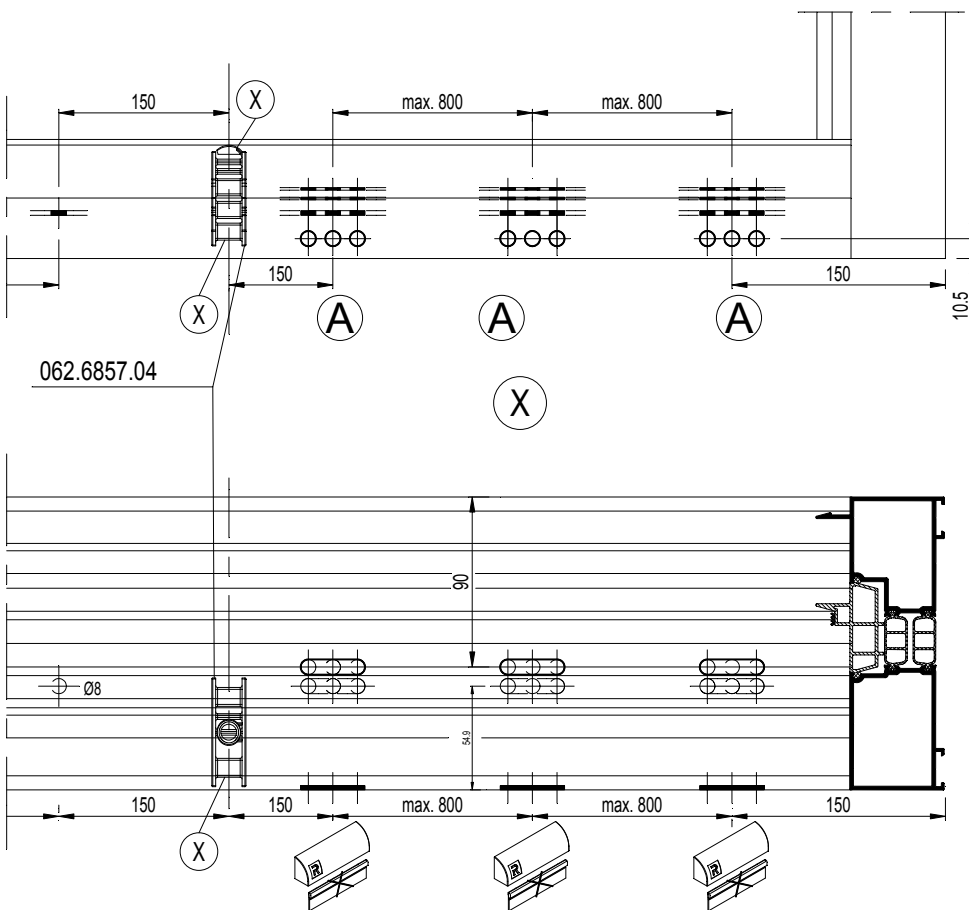
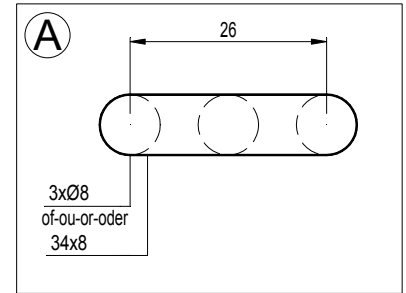
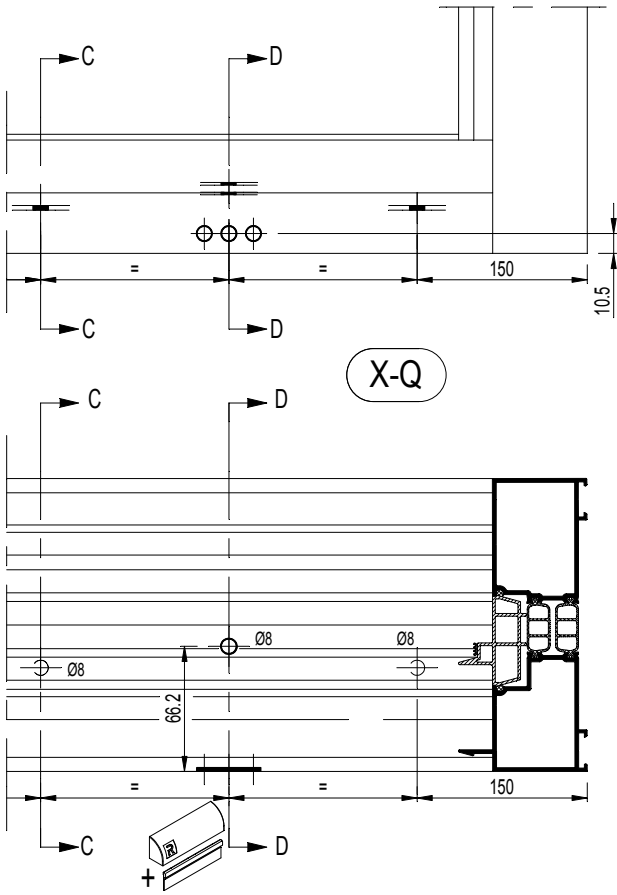

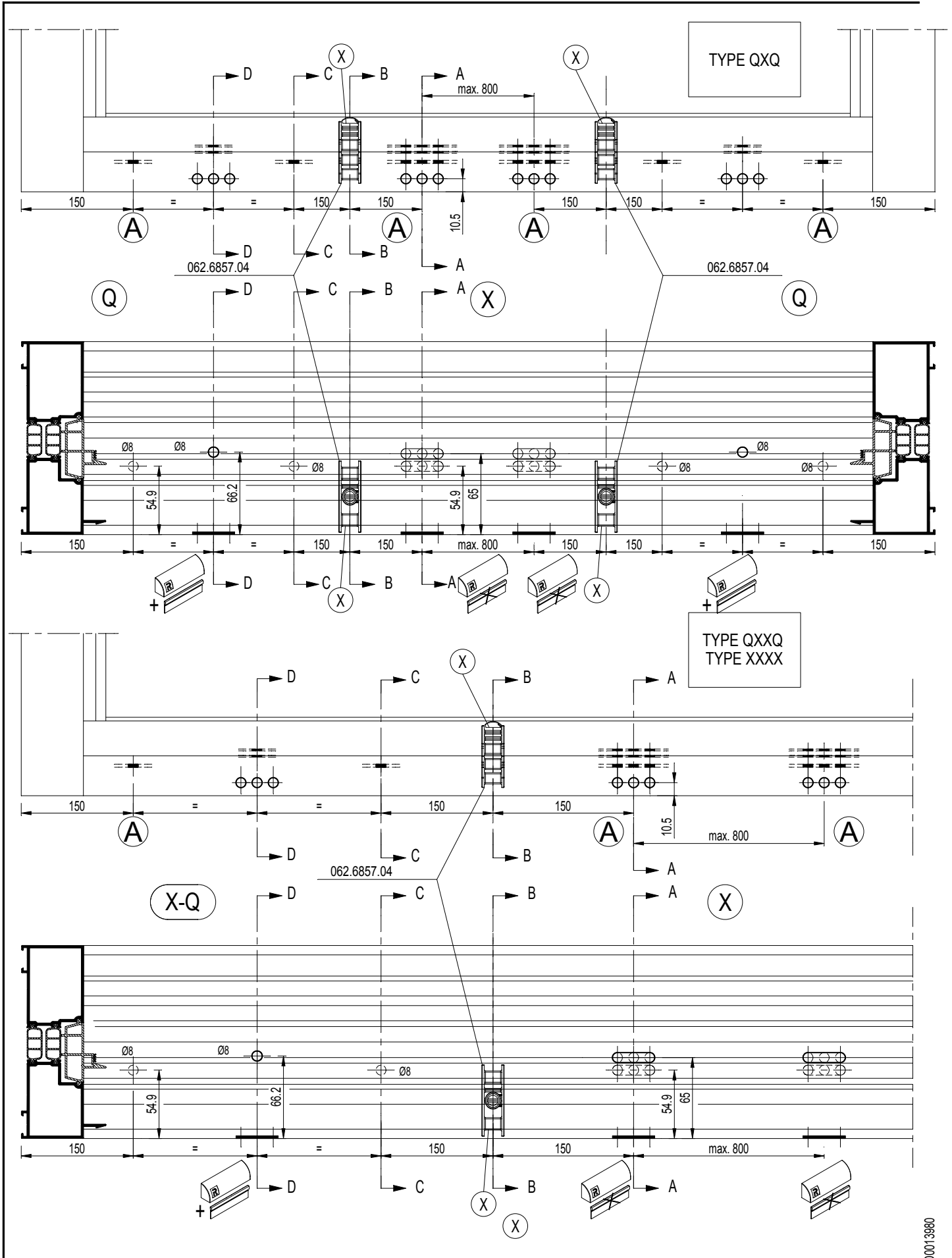

CP 155-LS

ONTWATERING TYPE QXQ QXXQ OXXO
 DRAINAGE TYPE QXQ QXXQ OXXO
 DRAINAGE TYPE QXQ QXXQ OXXO
 ENTWASSERUNG TYP QXQ QXXQ OXXO

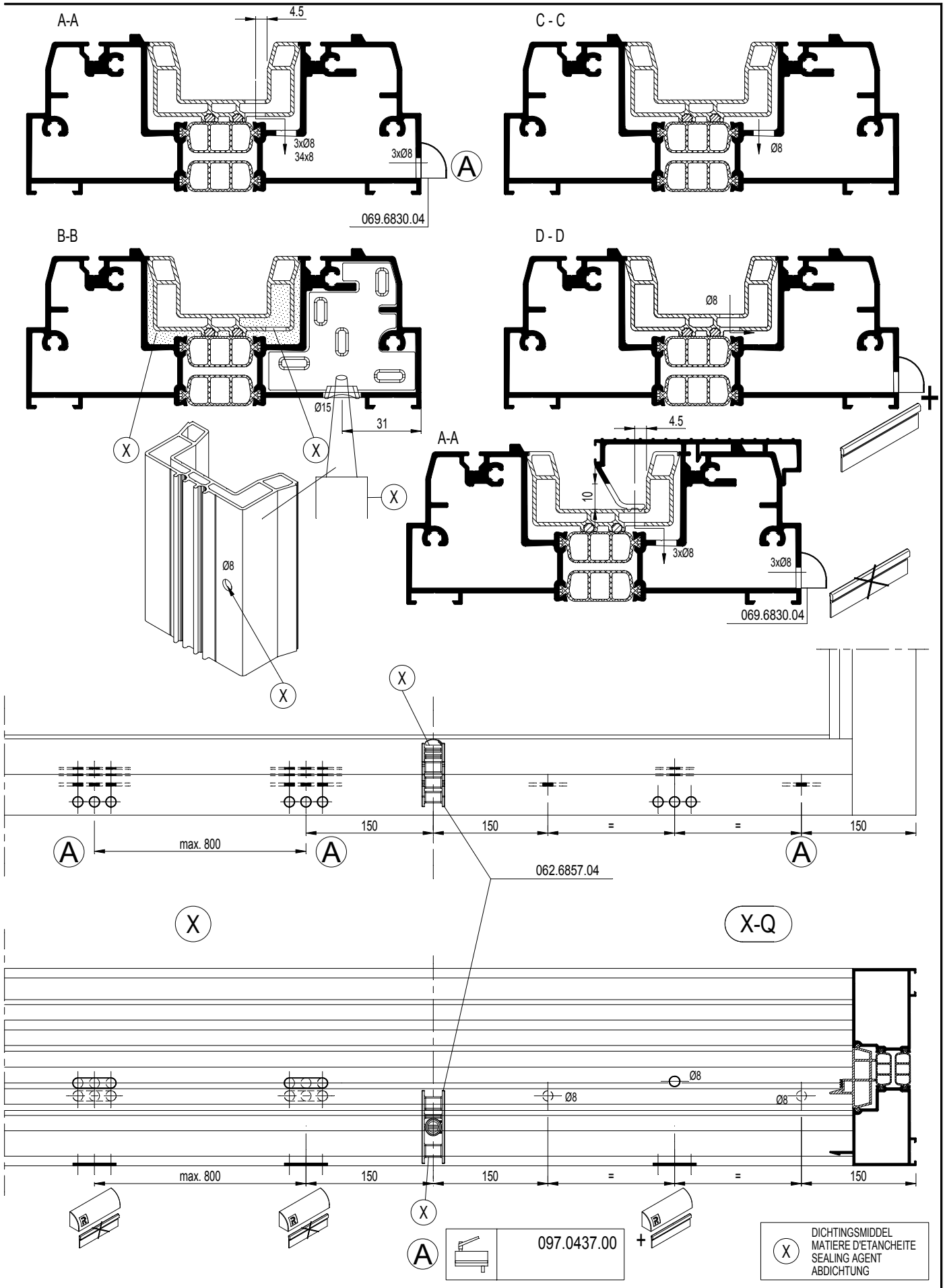

DECOMPRESSIE IN VAST RAAM MONORAIL
 DECOMPRESSION DANS CHASSIS FIXE MONORAIL
 DECOMPRESSION IN FIXED WINDOW MONORAIL
 DEKOMPRESSION IN DER FESTVERGLASUNG MONORAIL

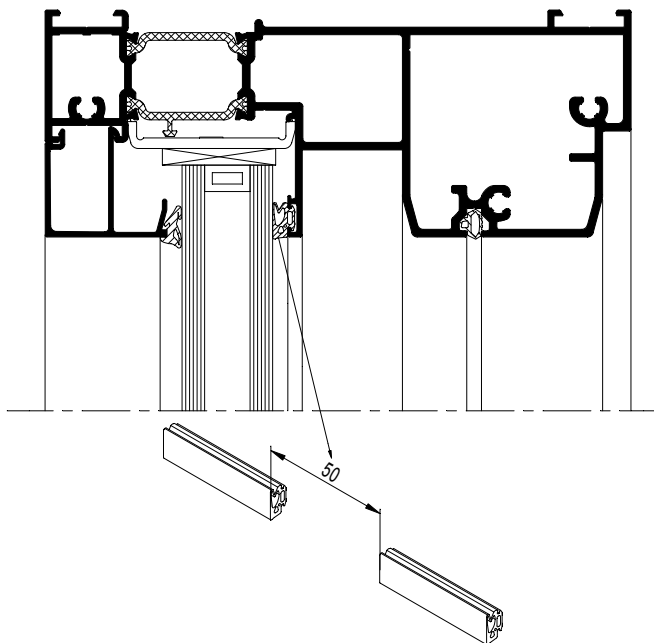
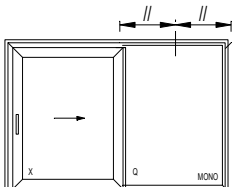

TYPE XQ

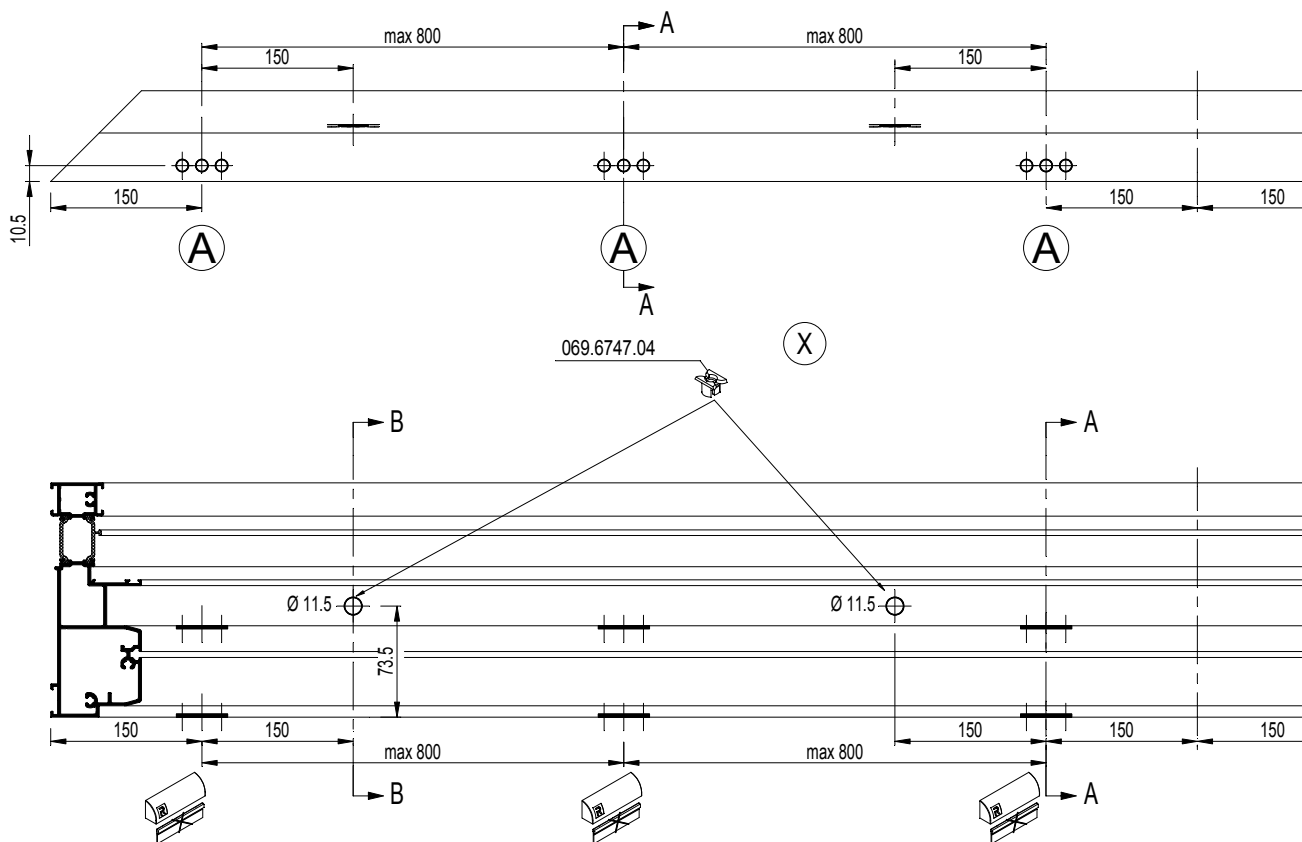

A - A

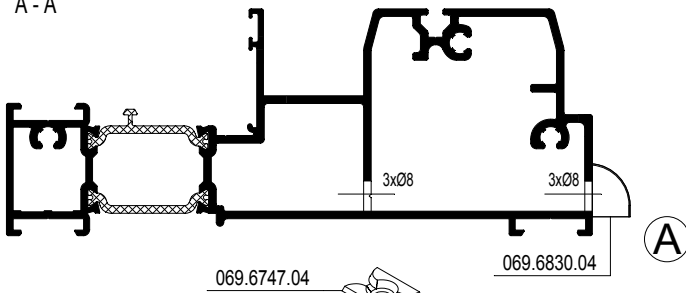

C - C

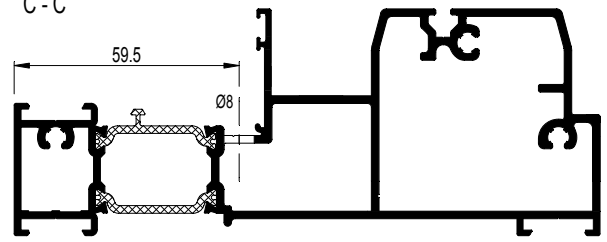

B - B

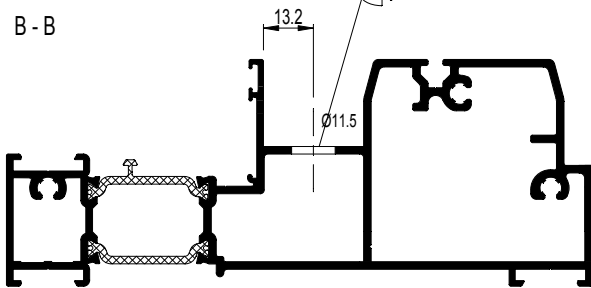

D - D

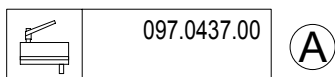
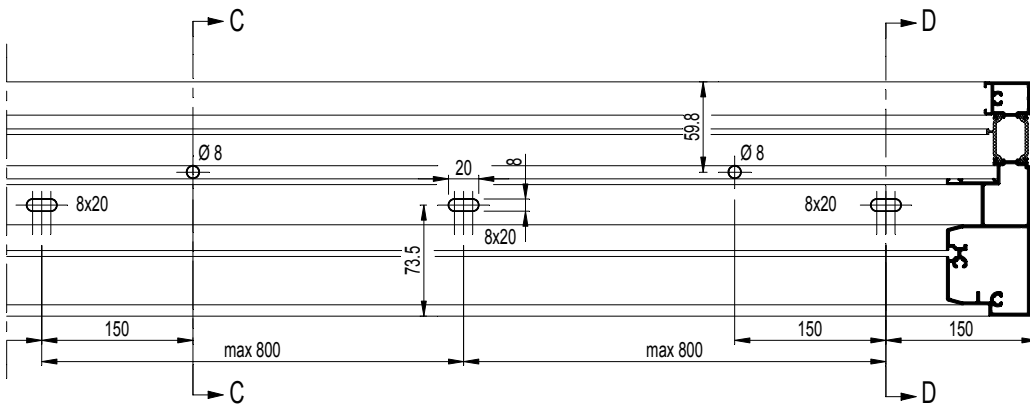
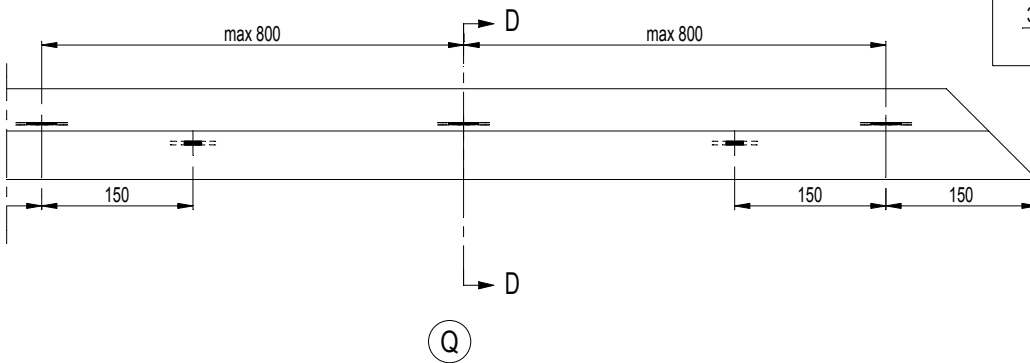
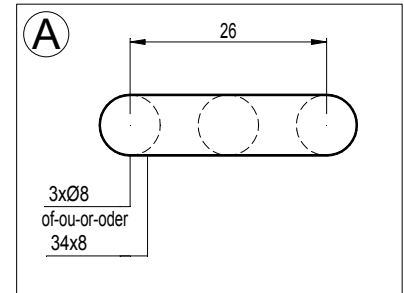
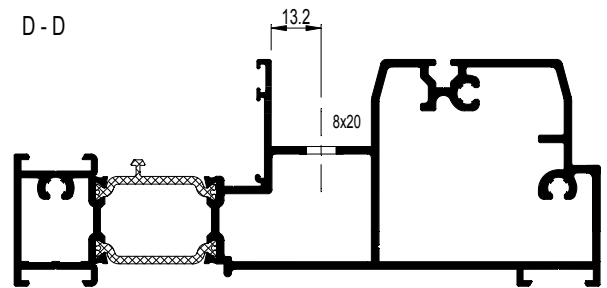

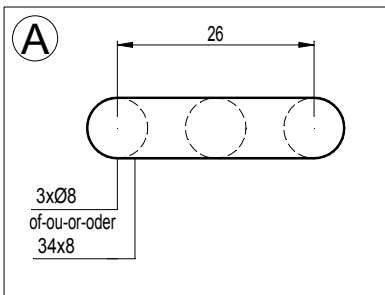

TYPE XQX

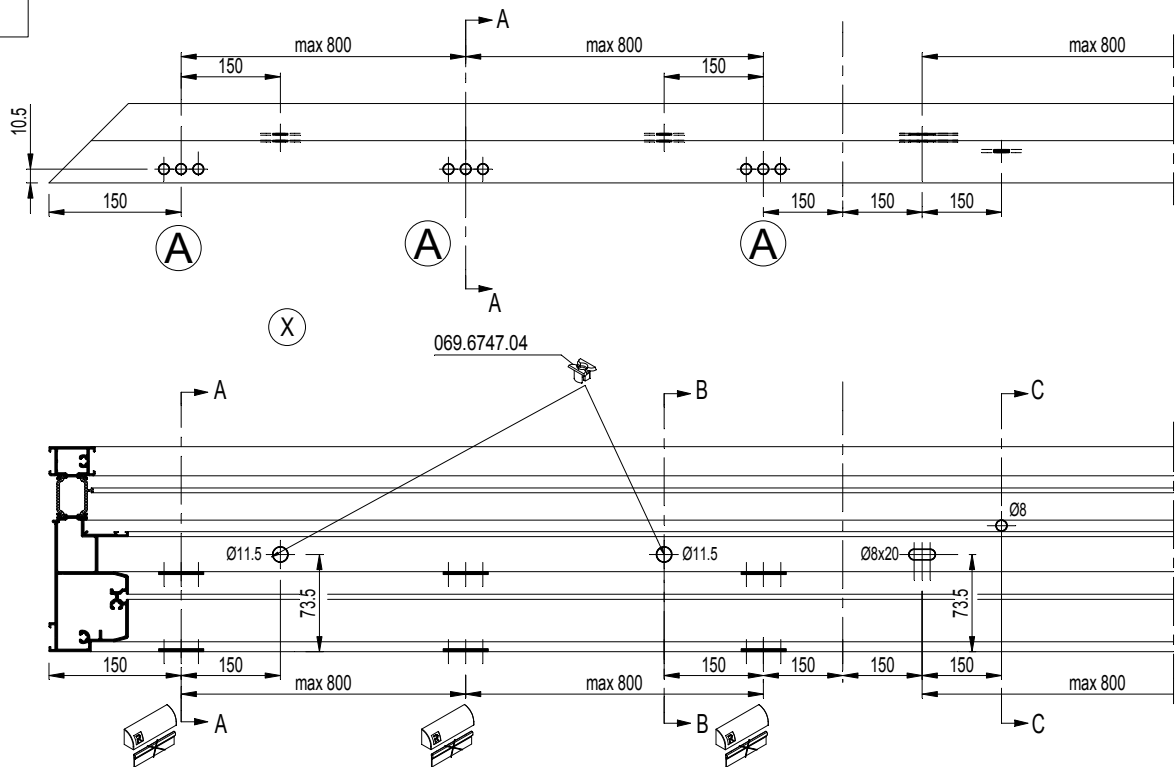

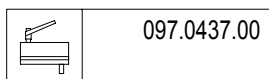
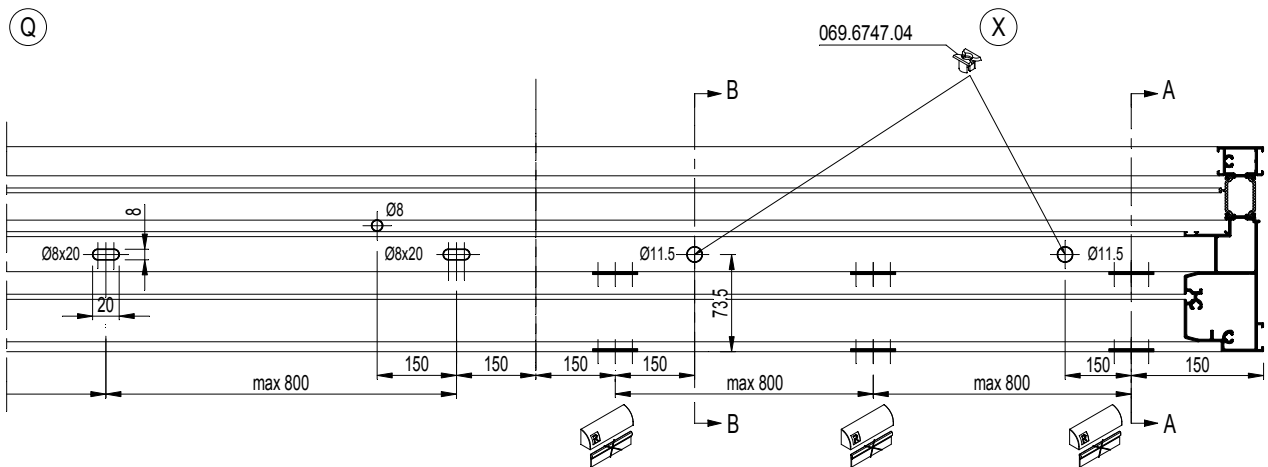
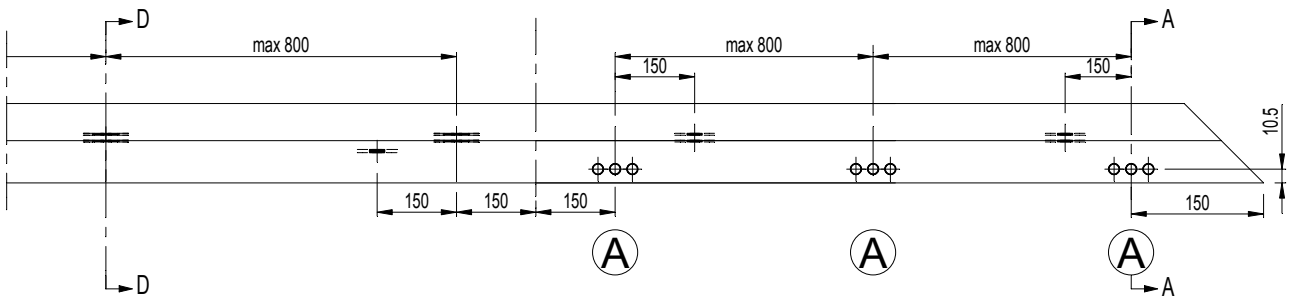
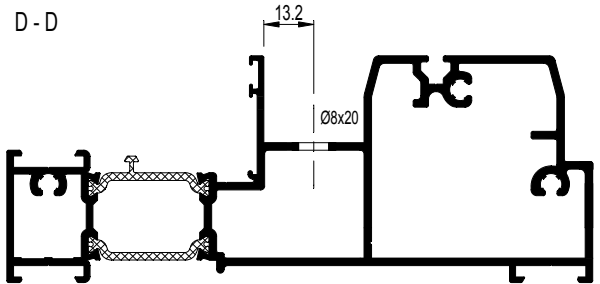
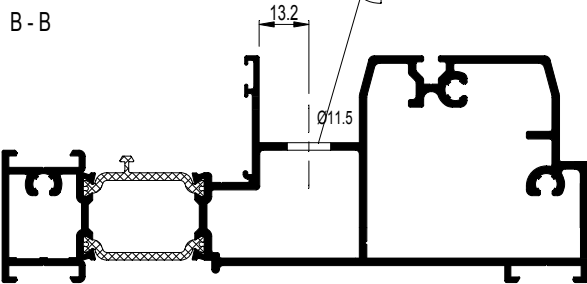
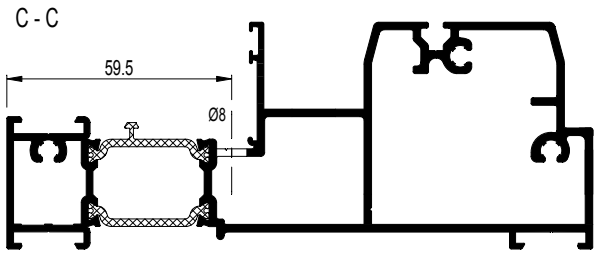
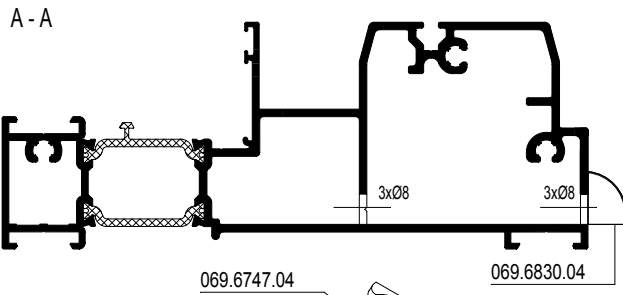

(A)

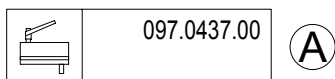
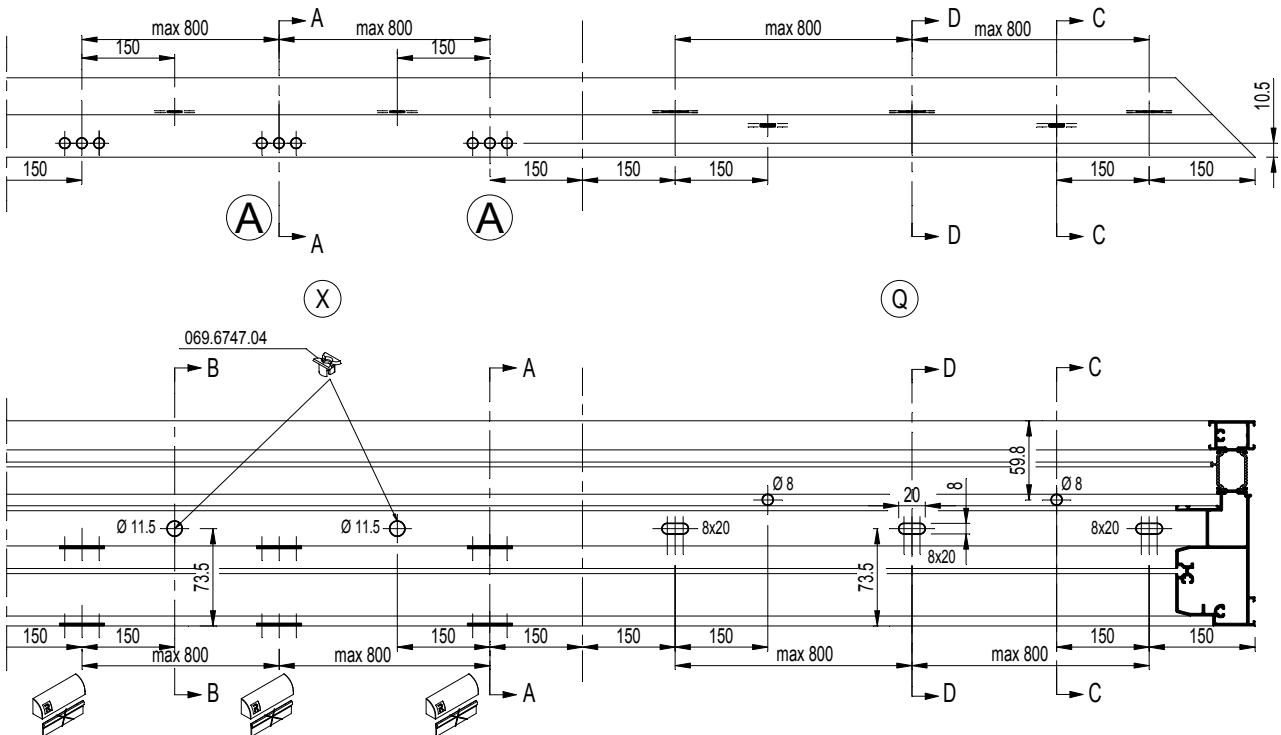
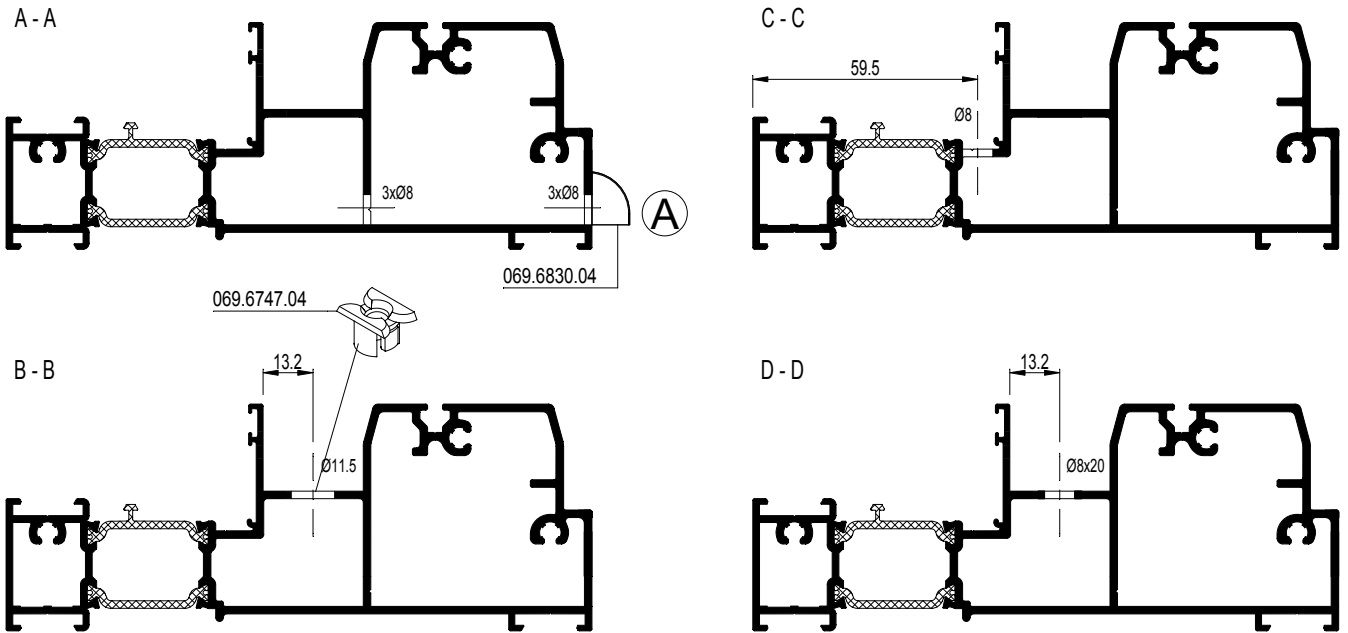

DECOMPRESSIE IN VAST RAAM MONORAIL
 DECOMPRESSION DANS CHASSIS FIXE MONORAIL
 DECOMPRESSION IN FIXED WINDOW MONORAIL
 DEKOMPRESSIE IN DER FESTVERGLASUNG MONORAIL

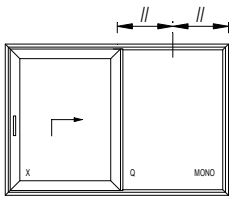
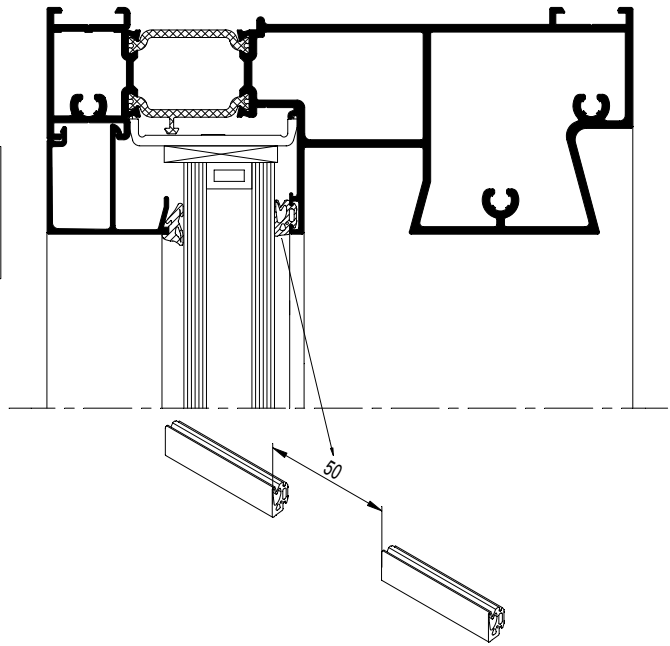

TYPE XQ

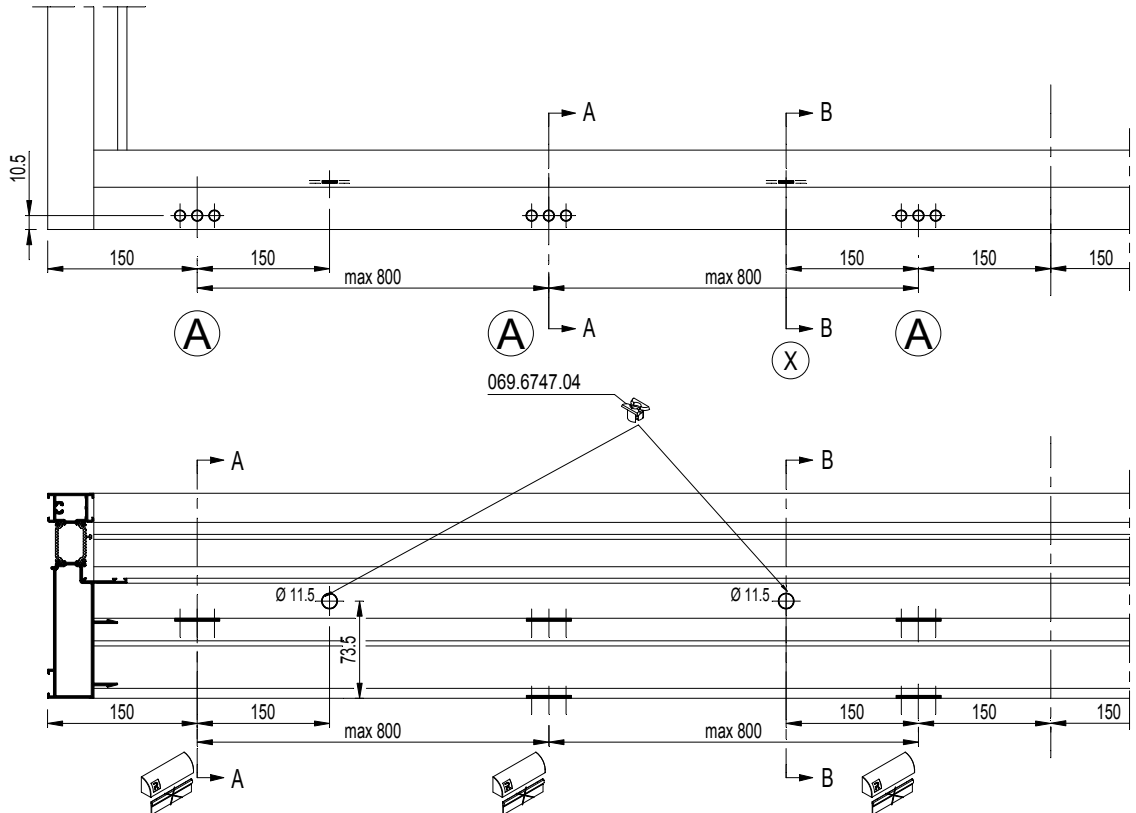

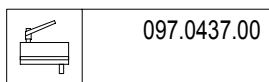
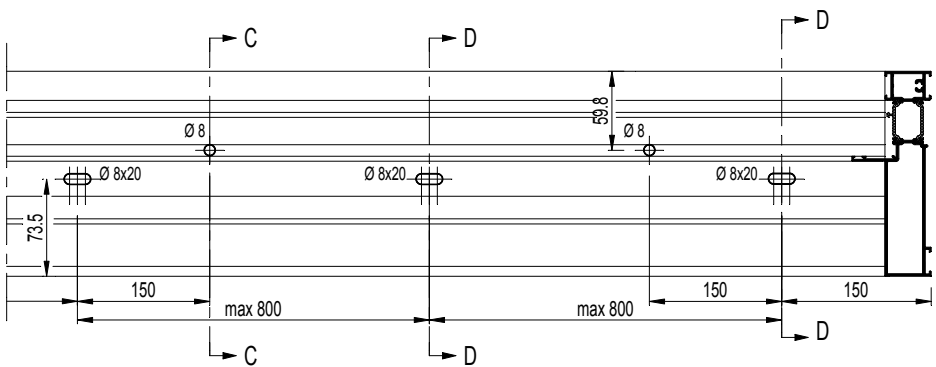
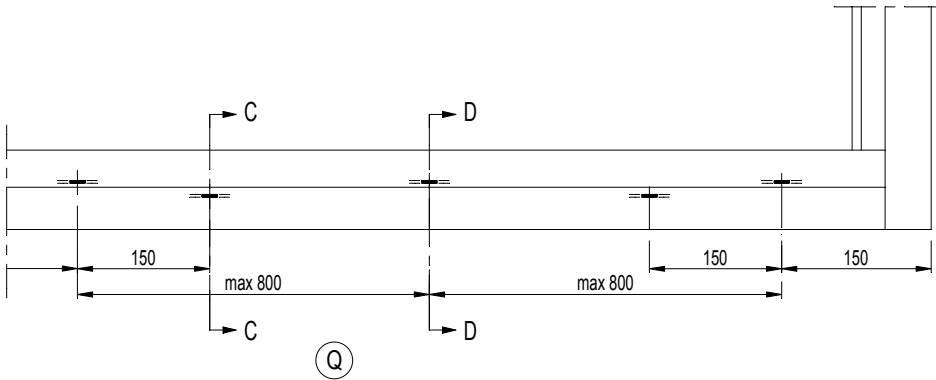
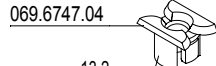
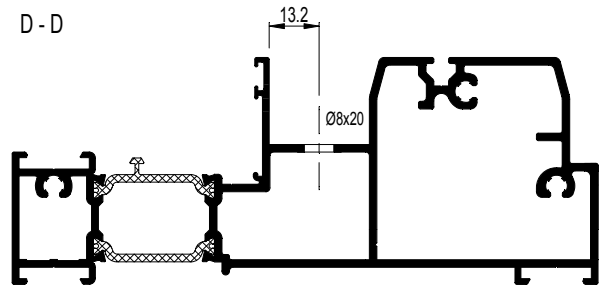
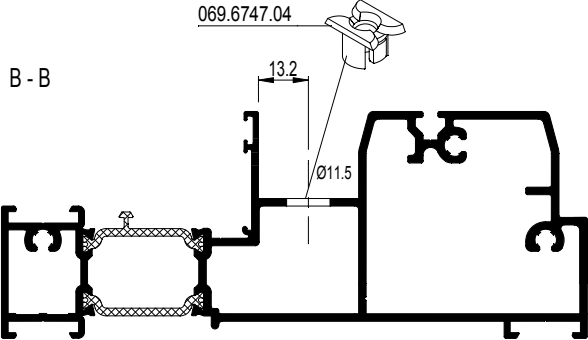
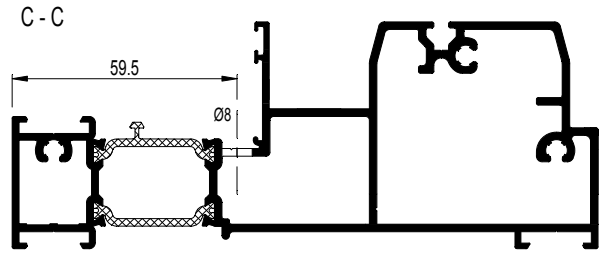
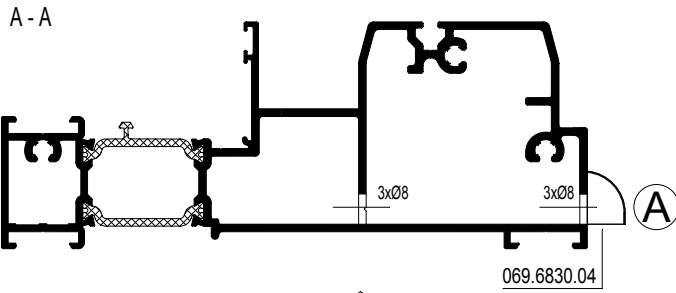

(A)

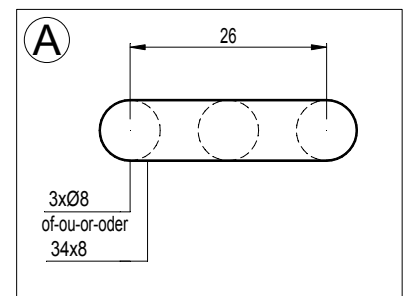

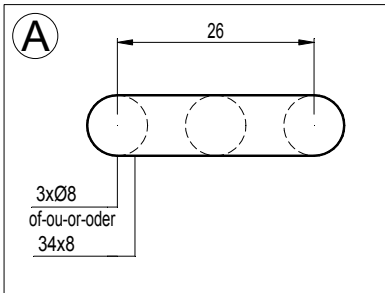

TYPE XQX

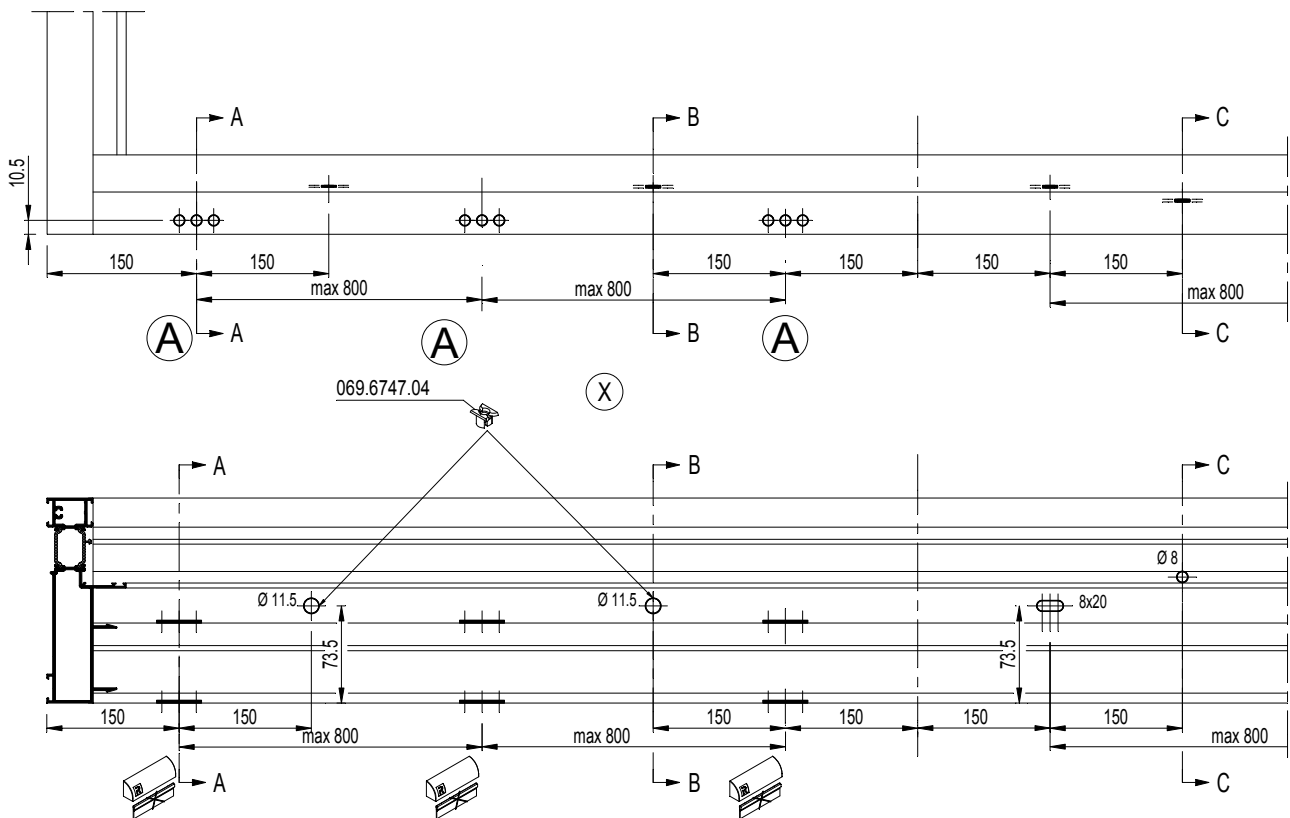

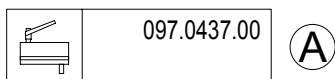
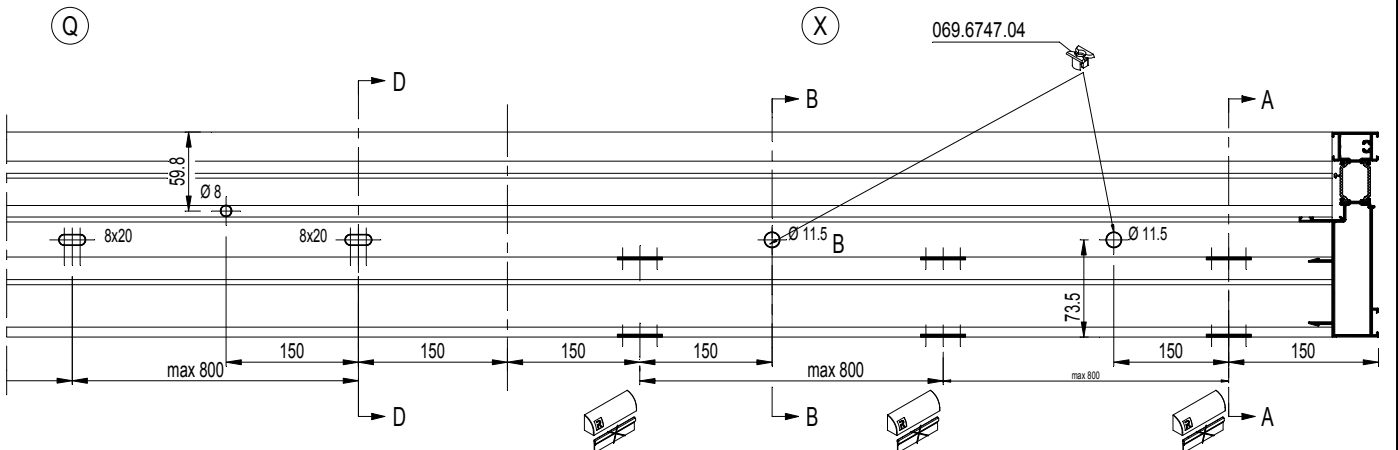
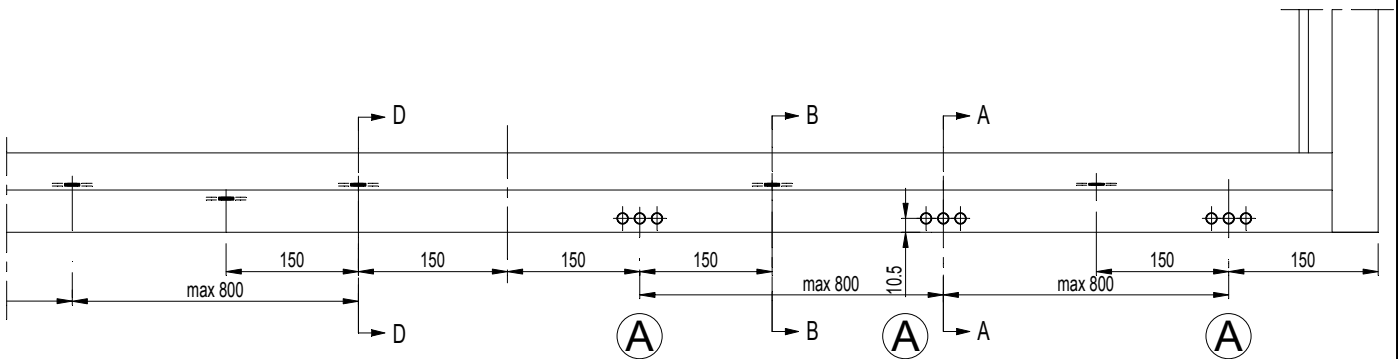
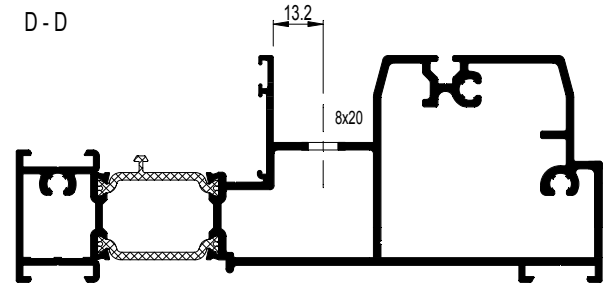
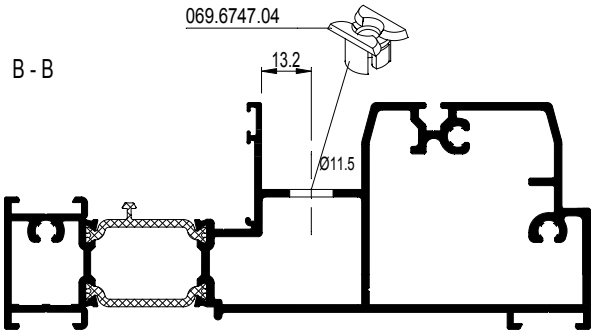
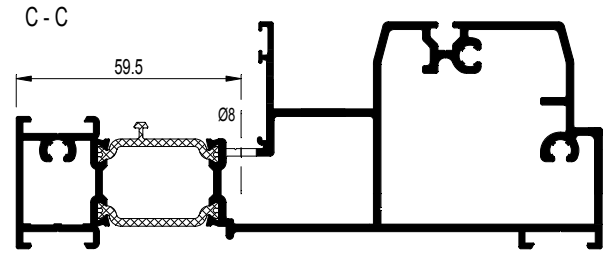
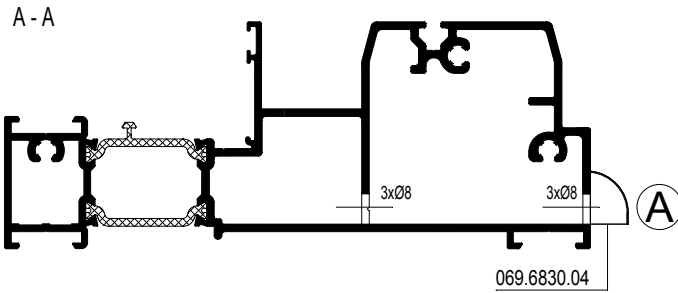

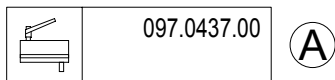
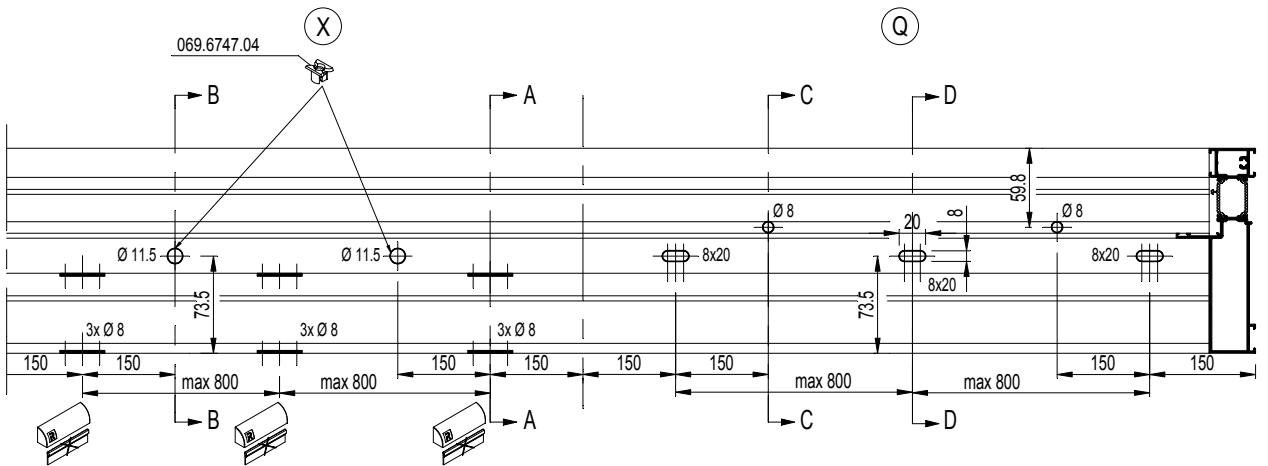
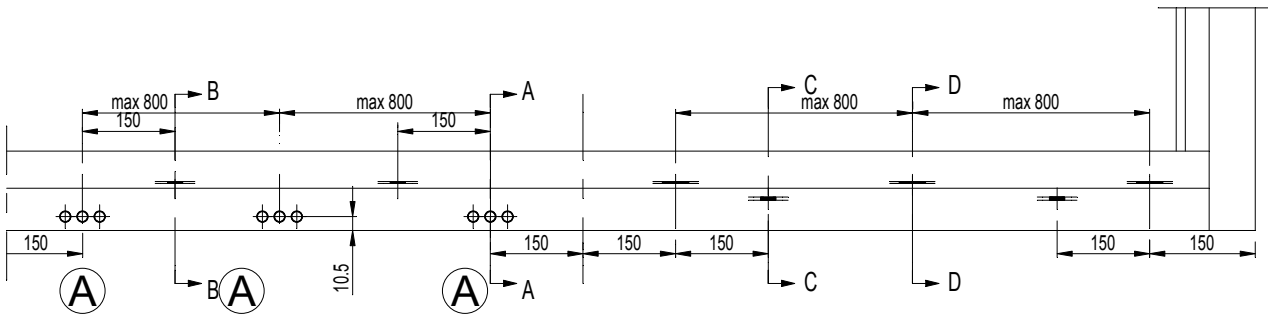
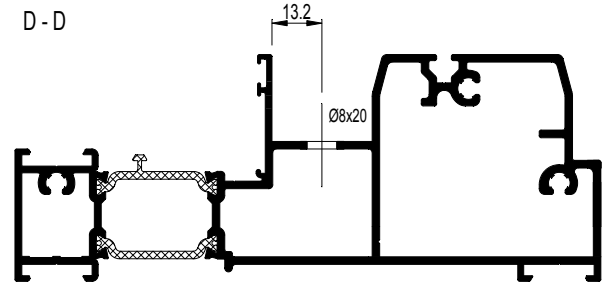
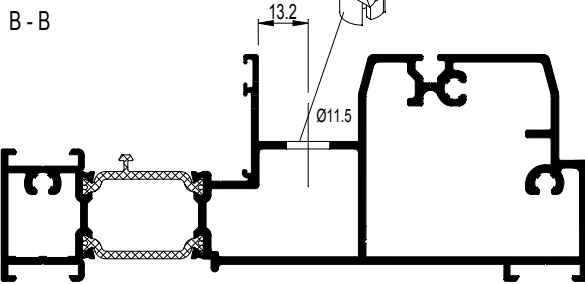
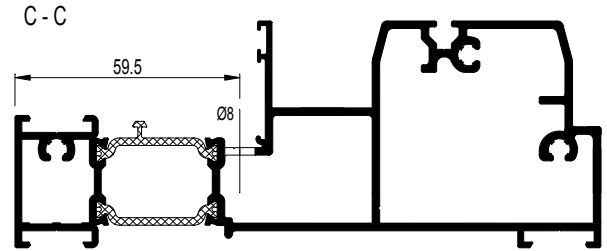
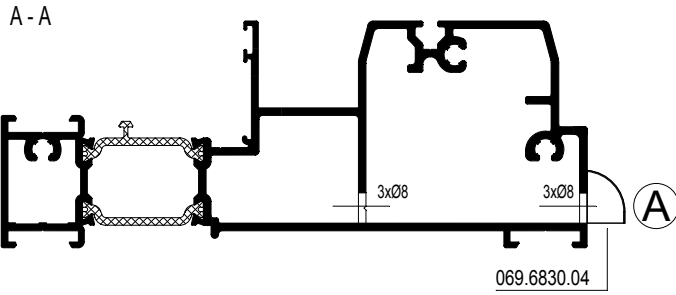

TYPE XXX
 TYPE XXQ

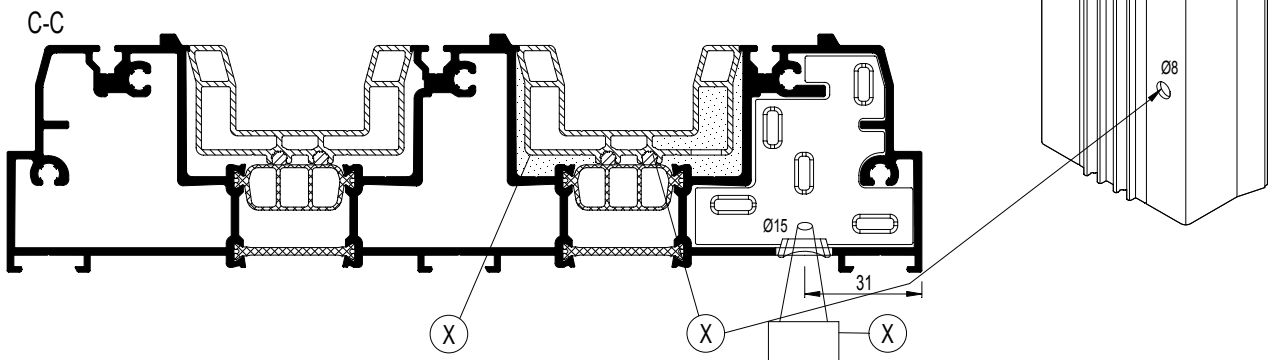
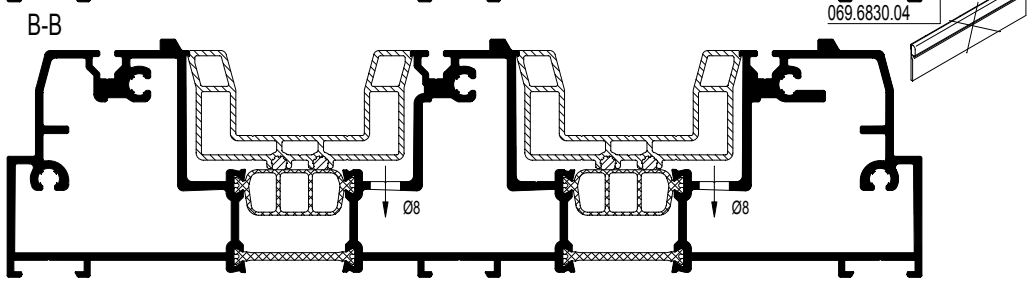
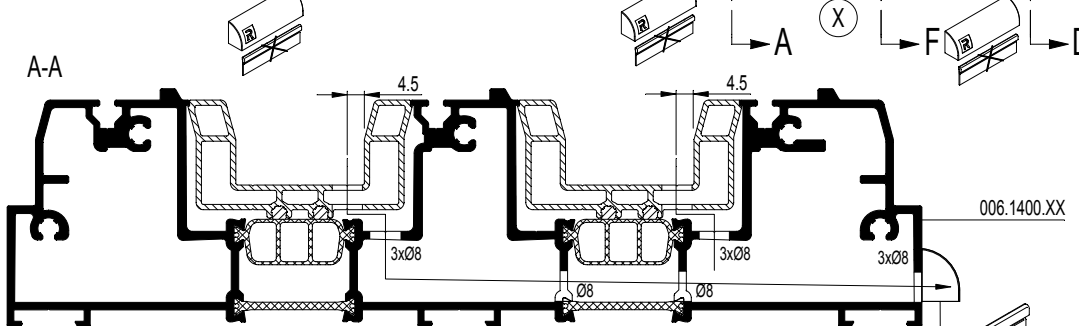
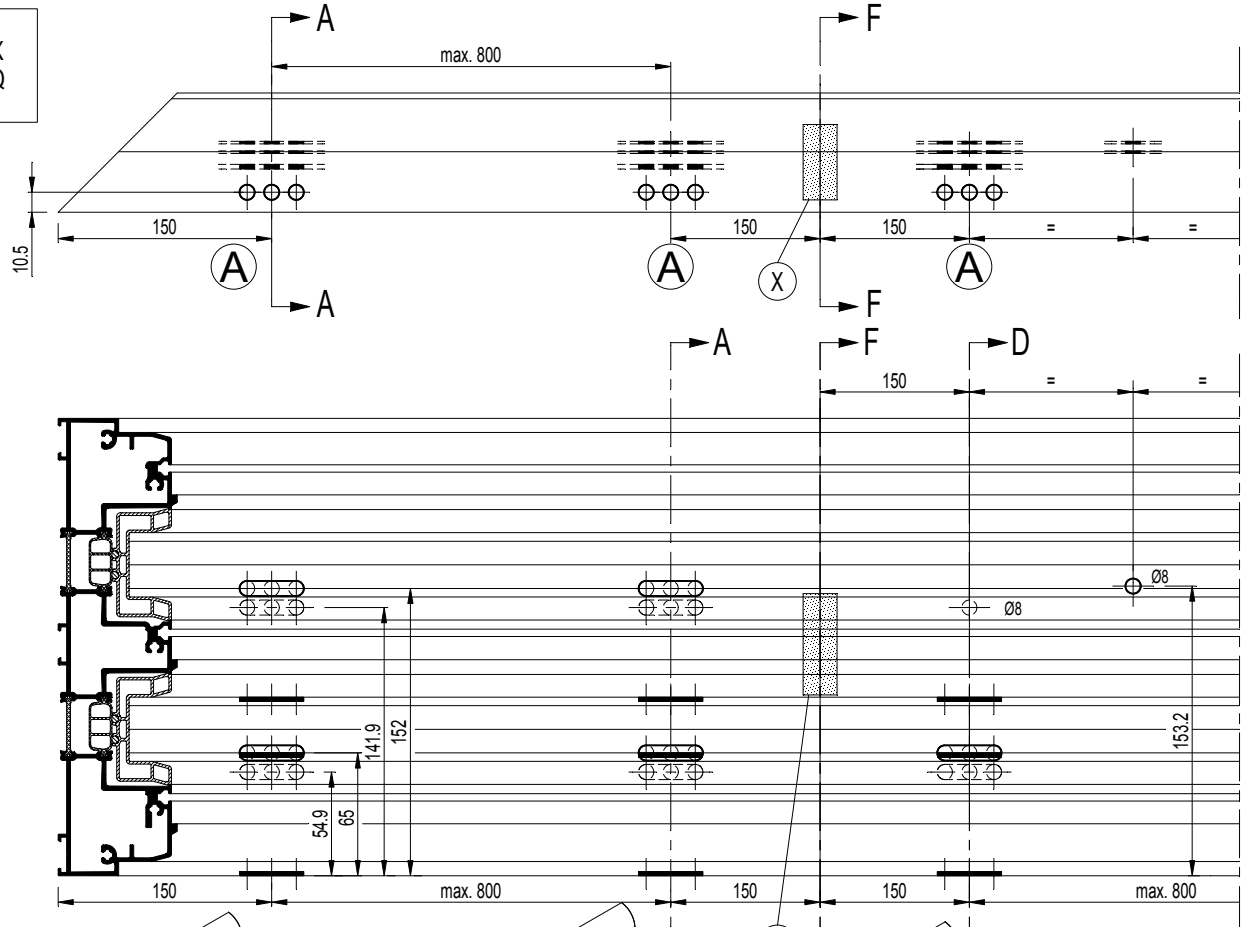

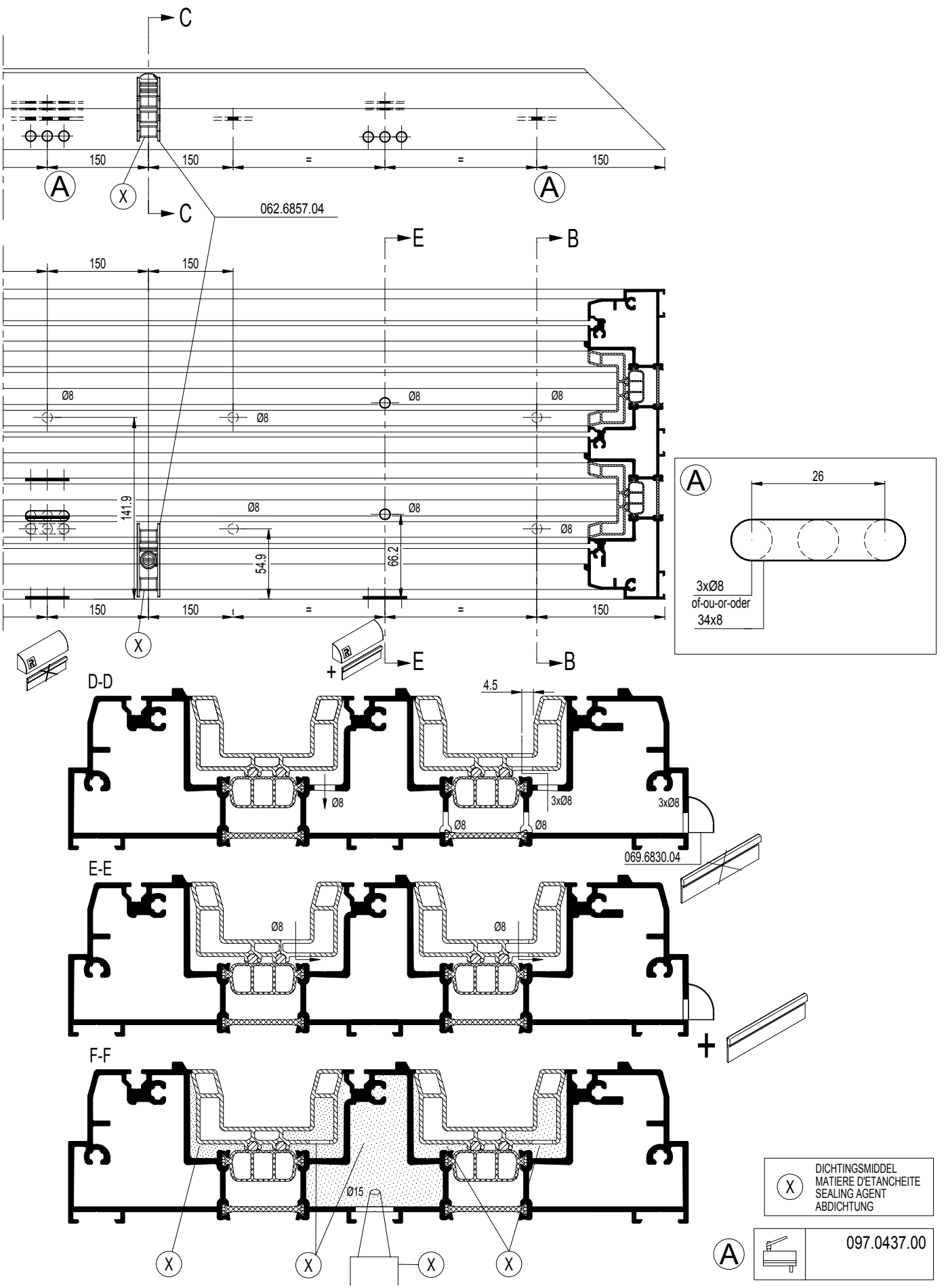

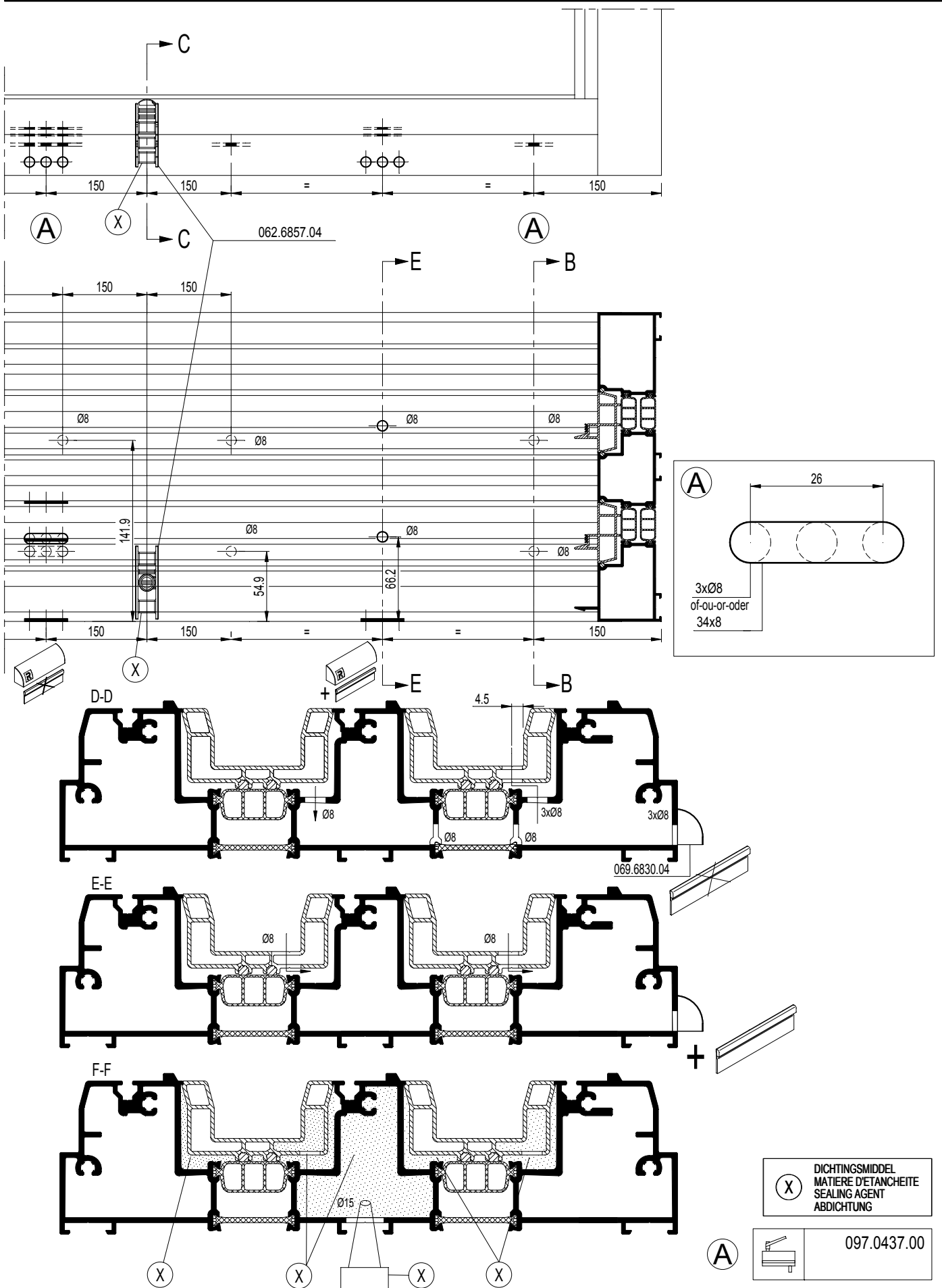

CP 155-LS/HI MINERGIE LABEL

ONTWATERING MONORAIL TYPE XQ
DRAINAGE MONORAIL TYPE XQ
DRAINAGE MONORAIL TYPE XQ
ENTWAESSERUNG MONORAIL TYP XQ

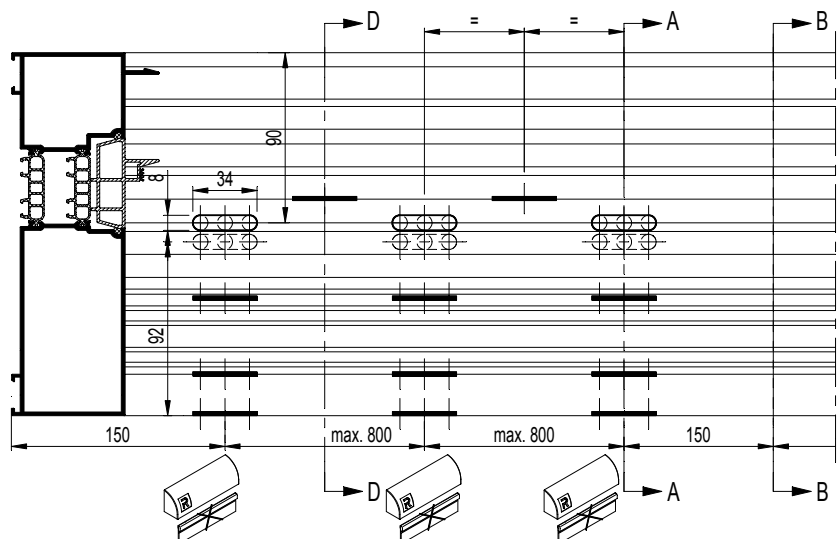
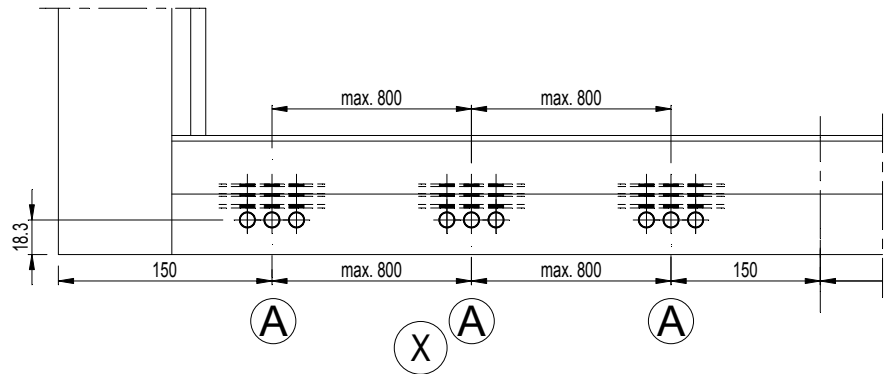
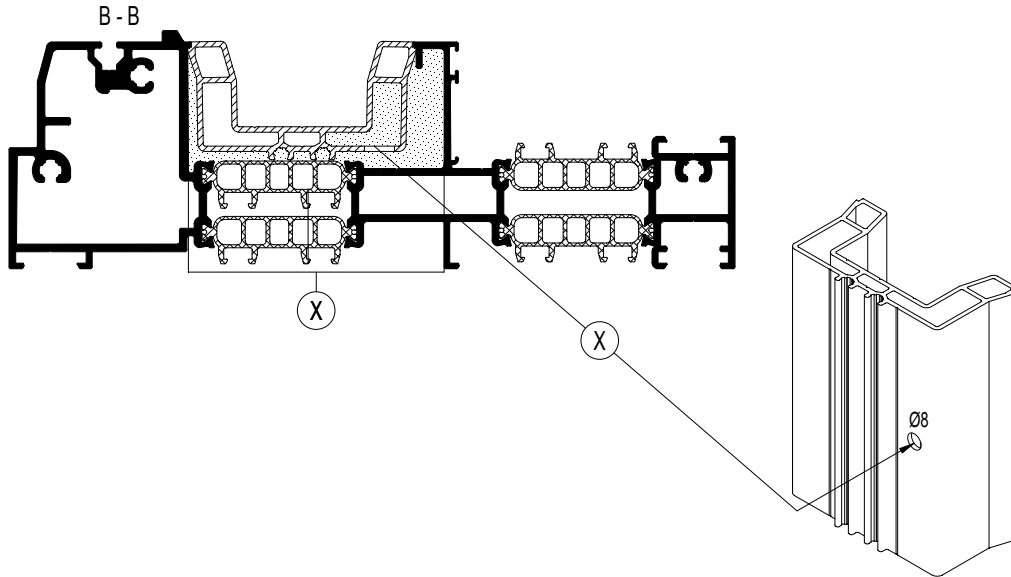
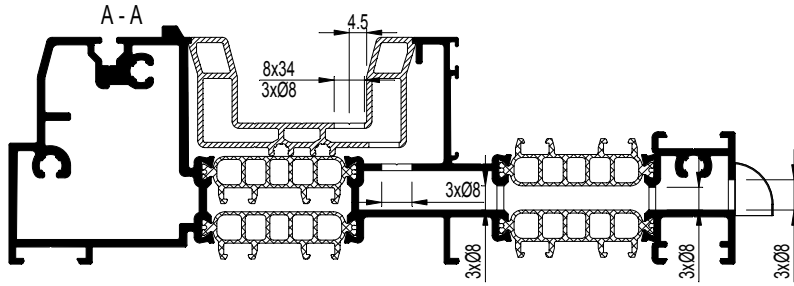

CP 155-LS/HI MINERGIE LABEL

ONTWATERING MONORAIL TYPE XQ
DRAINAGE MONORAIL TYPE XQ
DRAINAGE MONORAIL TYPE XQ
ENTWAESSERUNG MONORAIL TYP XQ

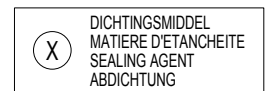
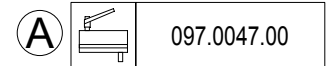
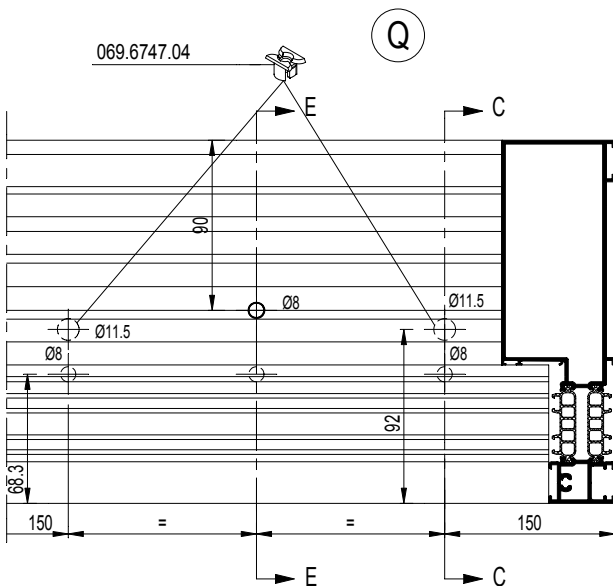
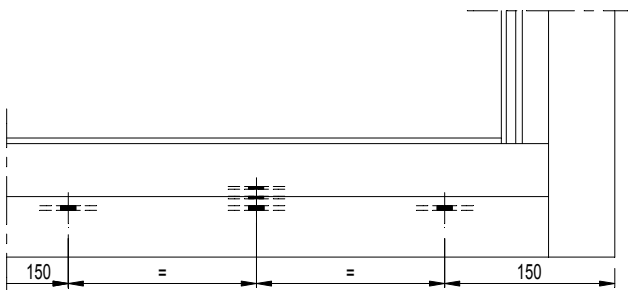
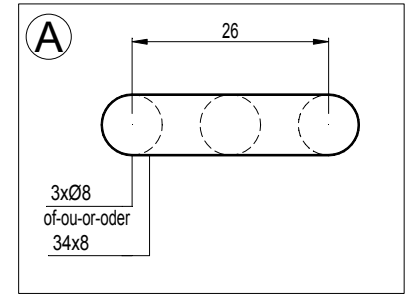
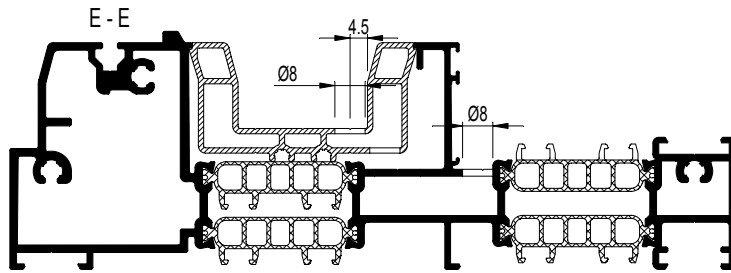
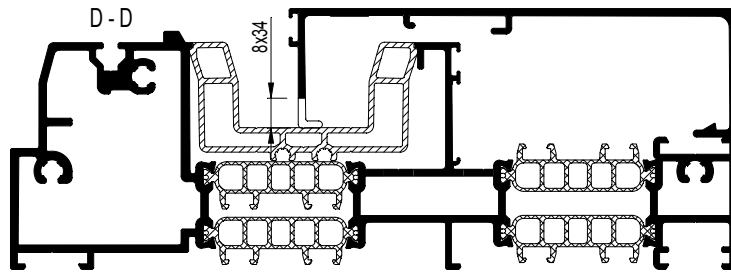
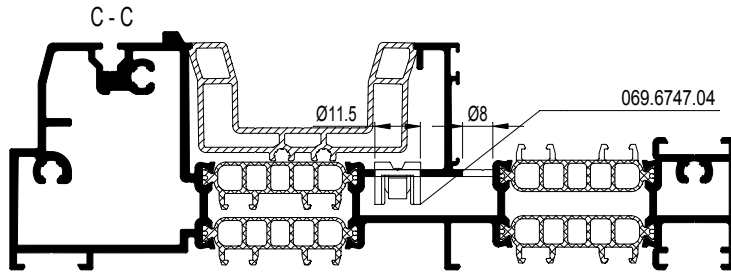

CP 155-LS/HI MINERGIE LABEL

ONTWATERING MONORAIL TYPE XQX QXQ
DRAINAGE MONORAIL TYPE XQX QXQ
DRAINAGE MONORAIL TYPE XQX QXQ
ENTWAESSERUNG MONORAIL TYP XQX QXQ

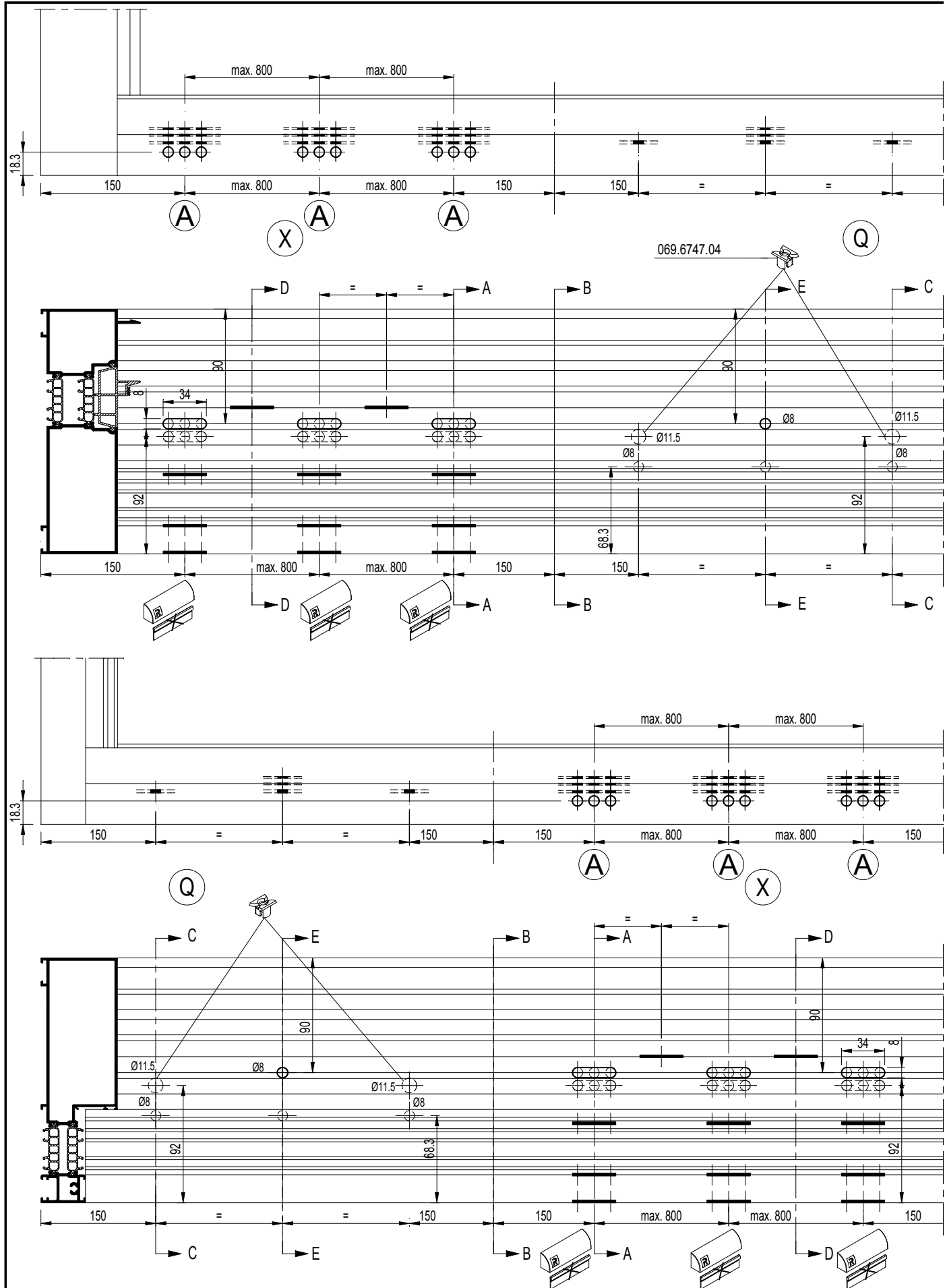

CP 155-LS/HI MINERGIE LABEL

ONTWATERING MONORAIL TYPE QXQ QXQ
 DRAINAGE MONORAIL TYPE QXQ QXQ
 DRAINAGE MONORAIL TYPE QXQ QXQ
 ENTWÄSSERUNG MONORAIL TYP QXQ QXQ

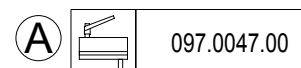
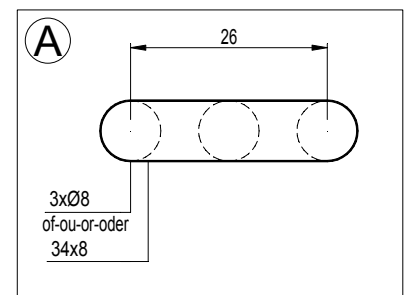
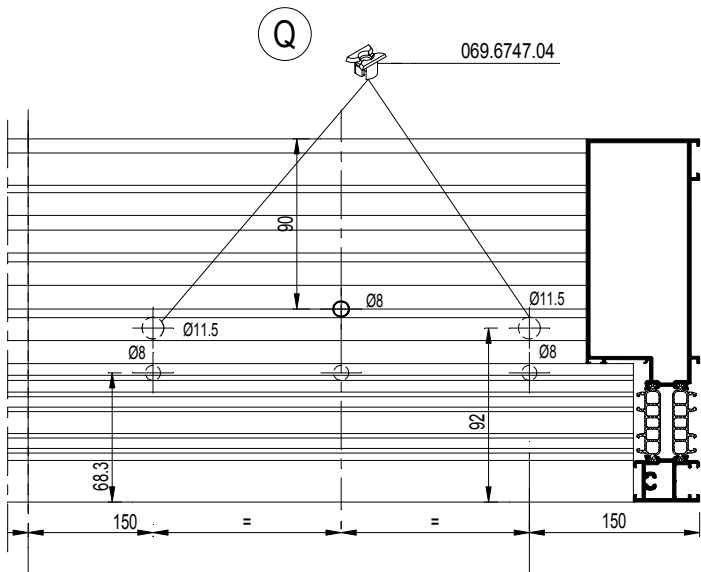
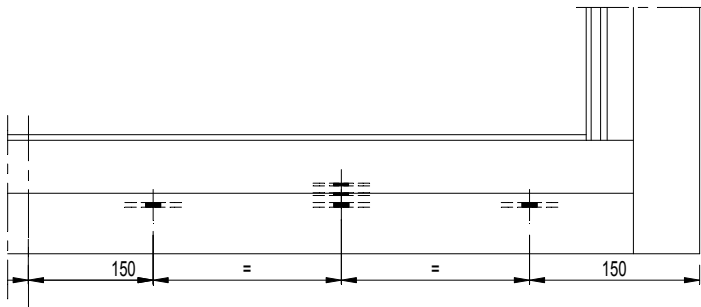
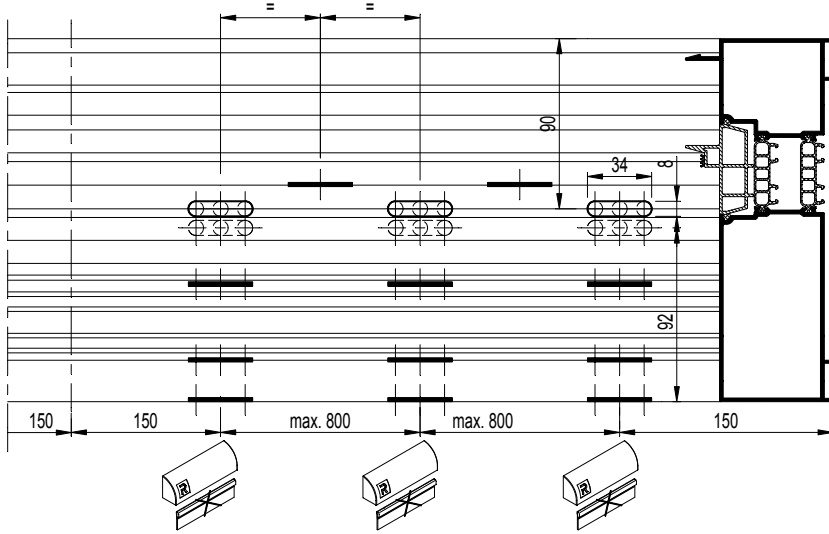
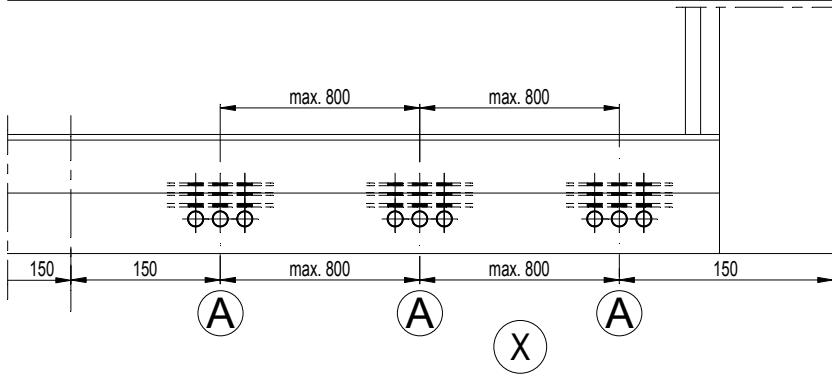

CP 155-LS/HI MINERGIE LABEL

ONTWATERING MONORAIL TYPE QXXQ
DRAINAGE MONORAIL TYPE QXXQ
DRAINAGE MONORAIL TYPE QXXQ
ENTWAESSERUNG MONORAIL TYP QXXQ

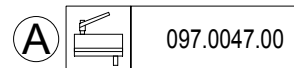
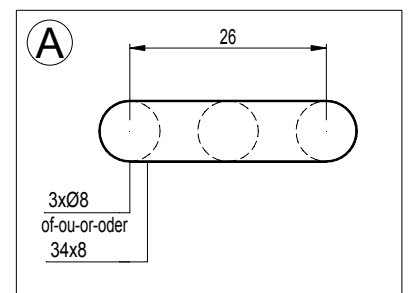
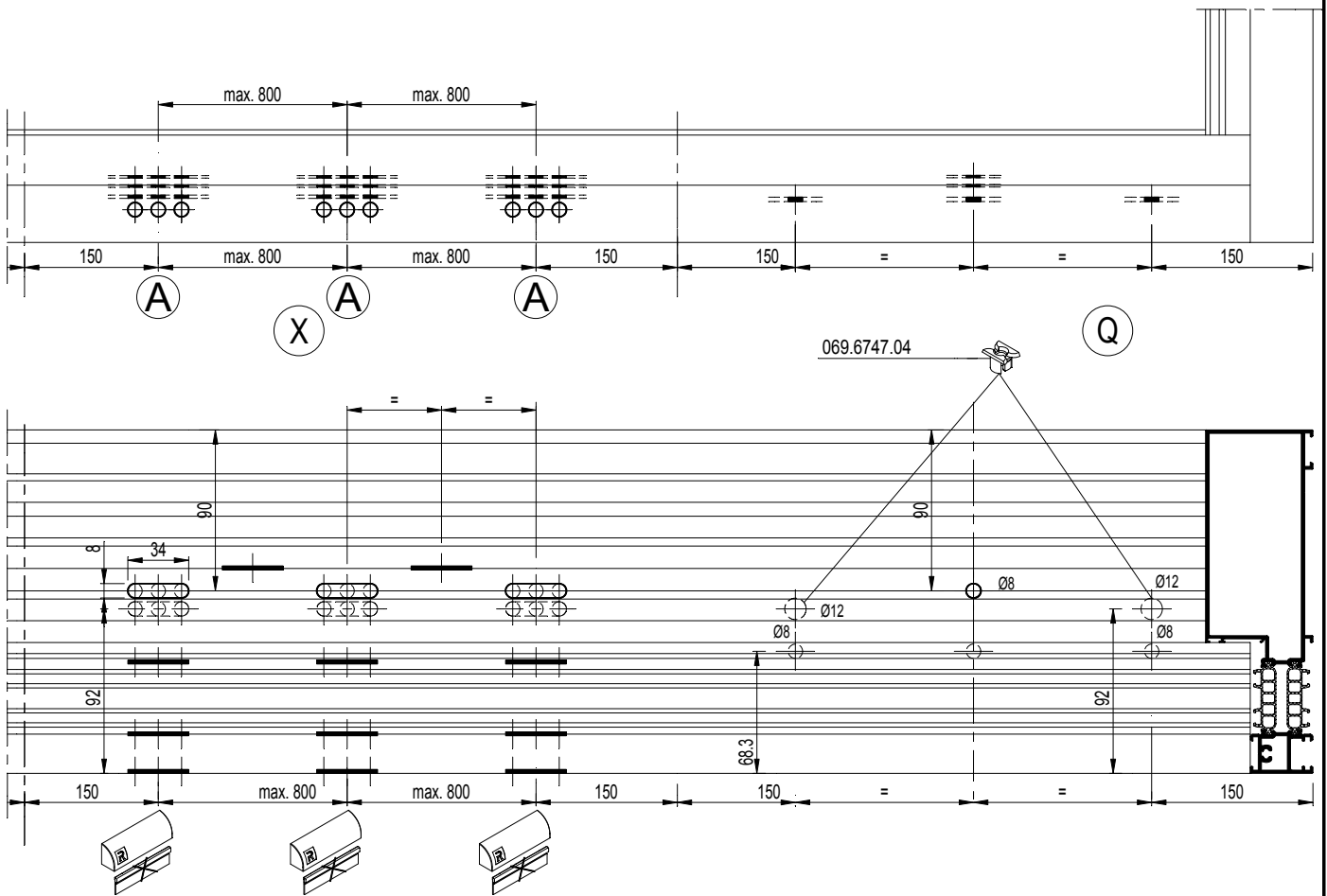

TYPE XQ

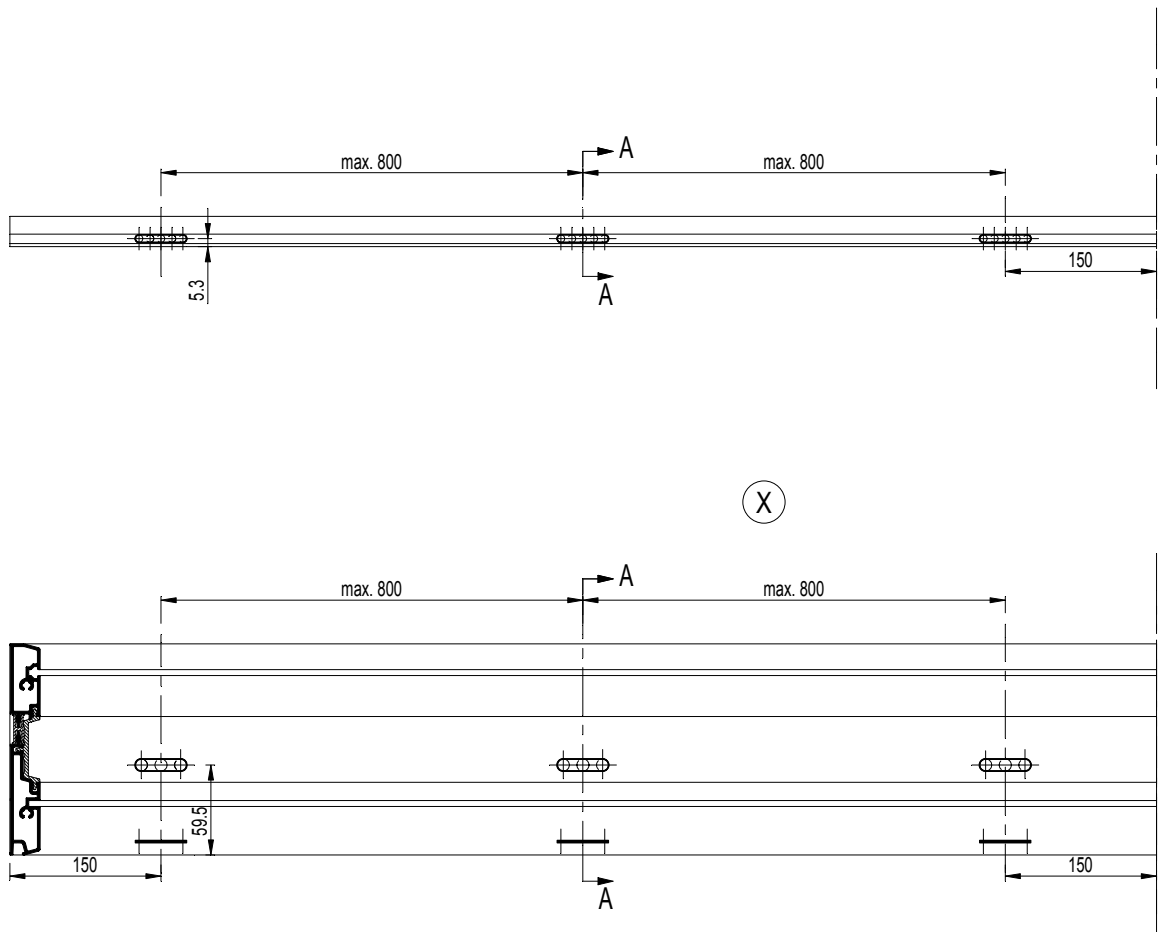
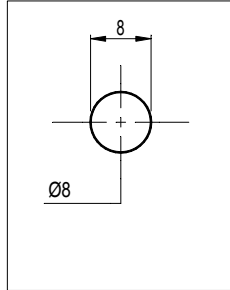
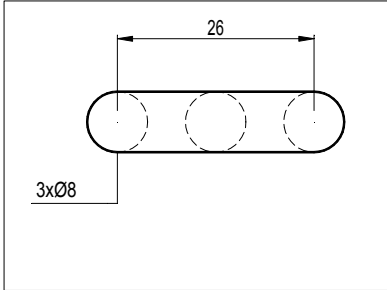

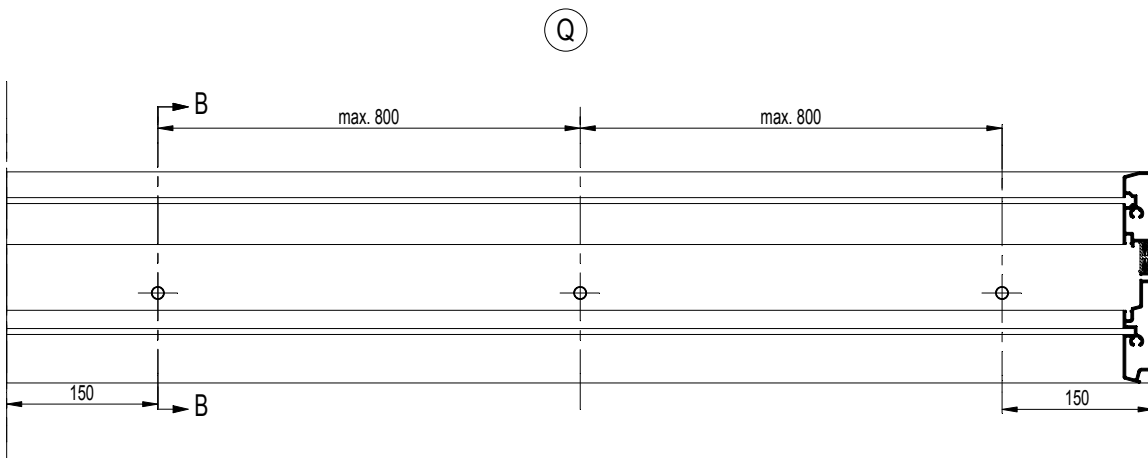
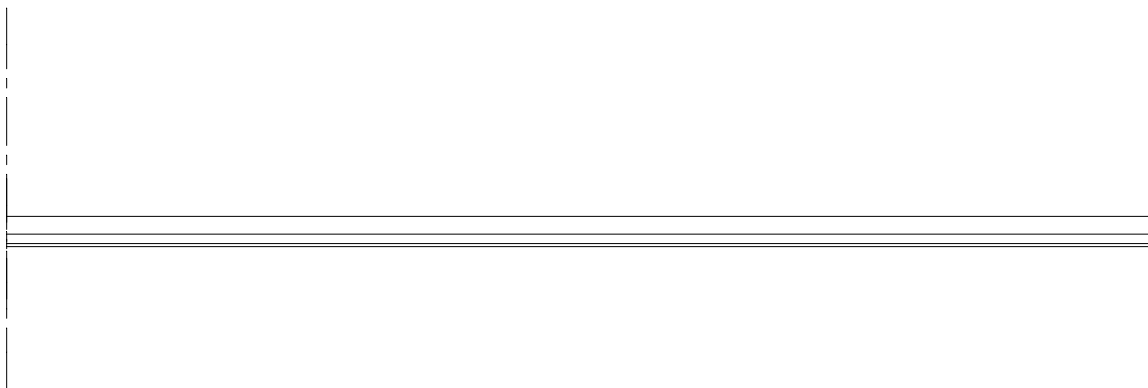
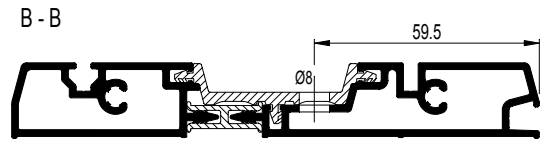
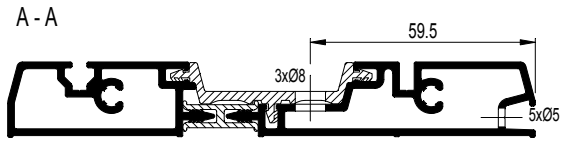

CP 155-HI CP 155-LS/HI

DECOMPRESSIE VLEUGELS
DECOMPRESSION OUVRANTS
DECOMPRESSION VENTS
DEKOMPRESSIÖN FLÜGELN



DECOMPRESSIE Ø5 IN DE VLEUGELS
DECOMPRESSION Ø5 DANS LES OUVRANTS
DECOMPRESSION Ø5 IN THE VENTS
DEKOMPRESSIÖN Ø5 IN DEN FLÜGELN

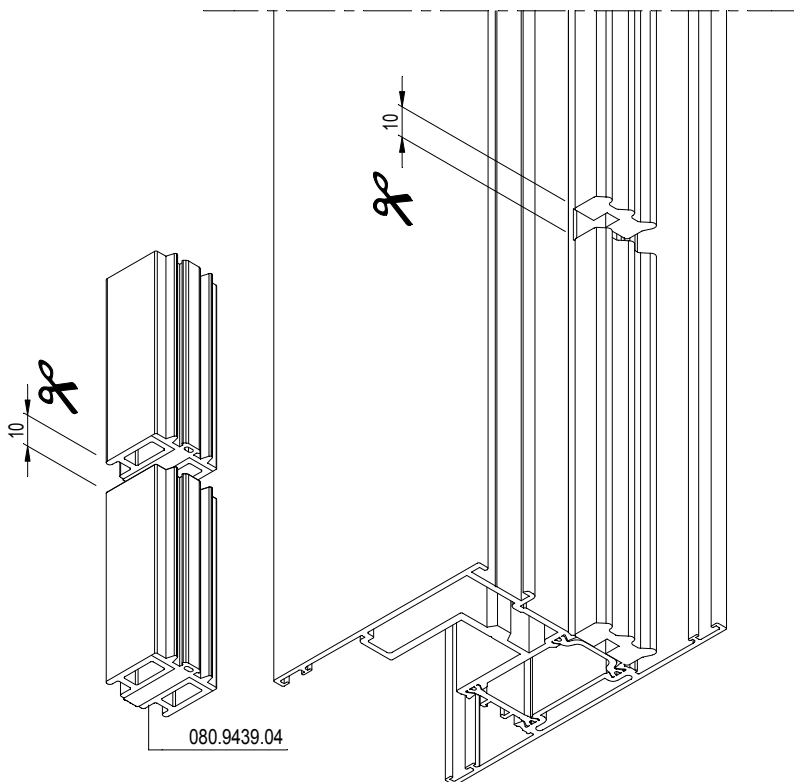
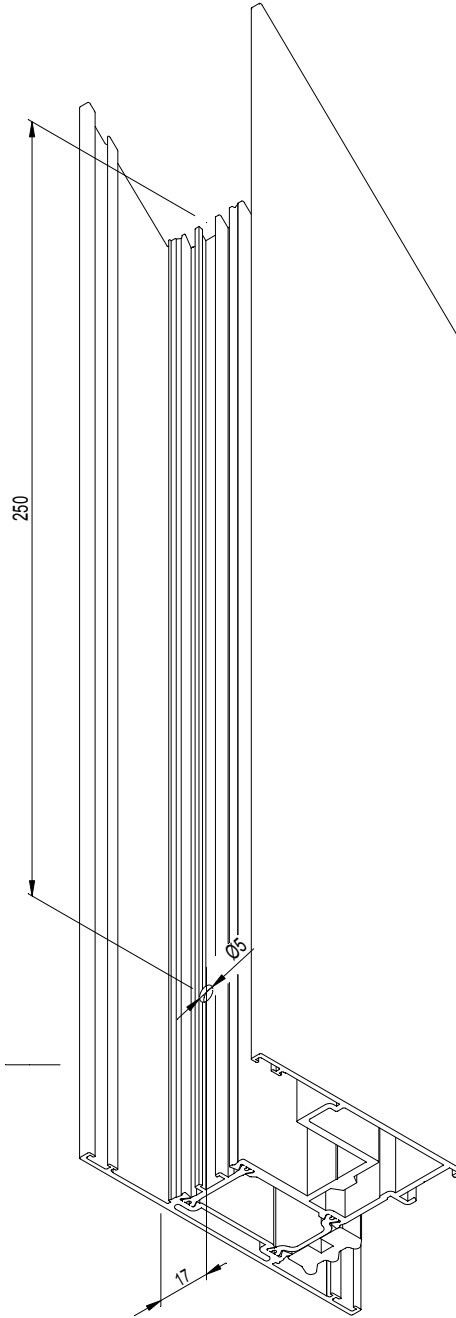
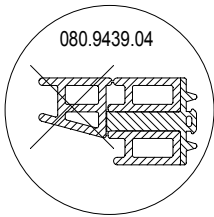
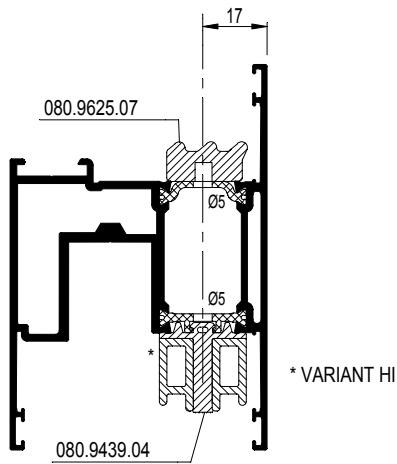
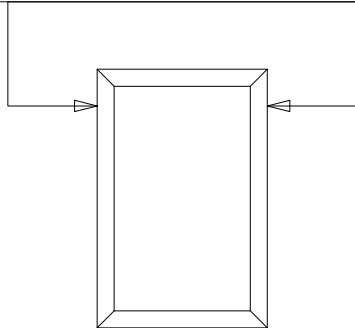

CP 155-HI CP 155-LS/HI

ONTWATERING VLEUGEL
DRAINAGE OUVRANT
DRAINING Ø8 IN THE VENTS
ENTWÄSSERUNG FLÜGEL

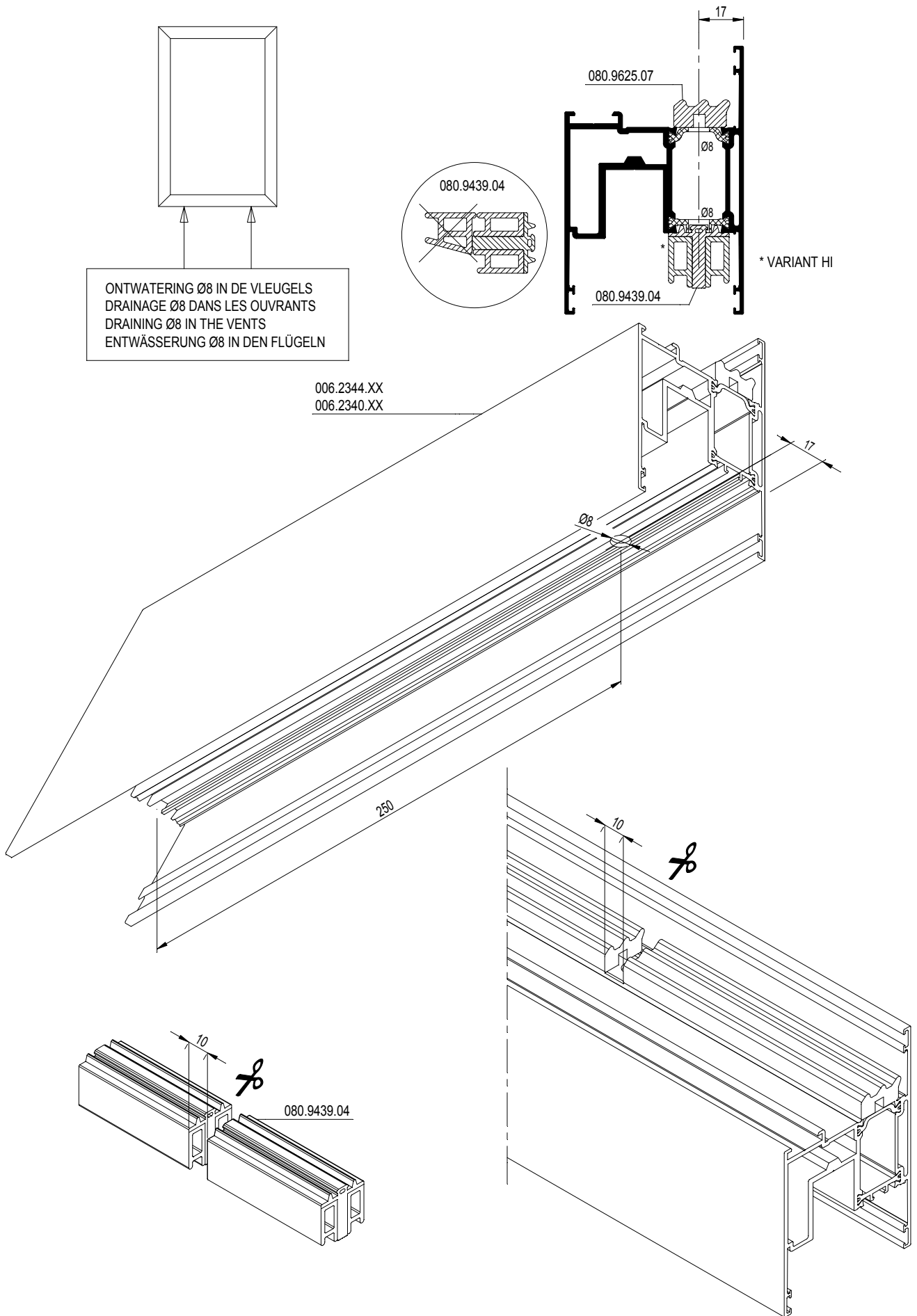

095.H800.00

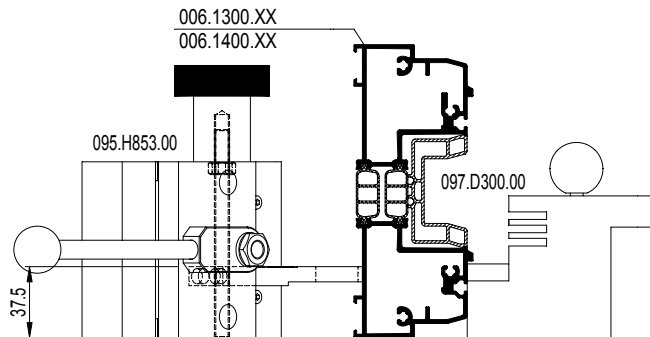
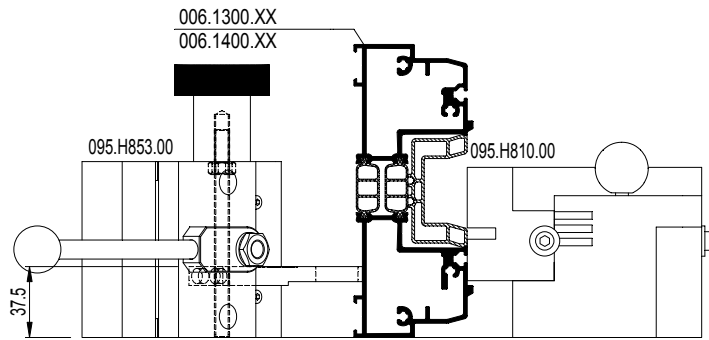

095.B500.00

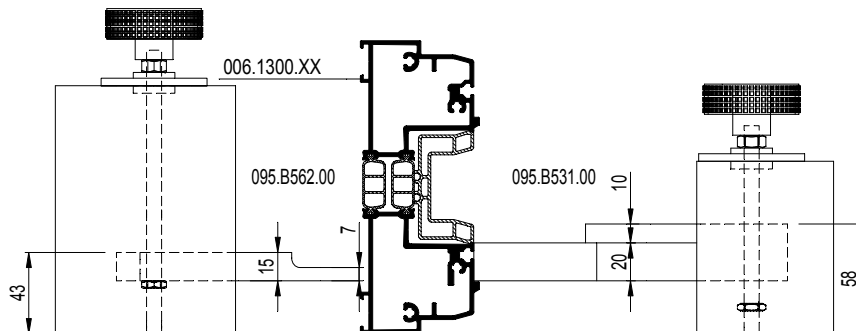
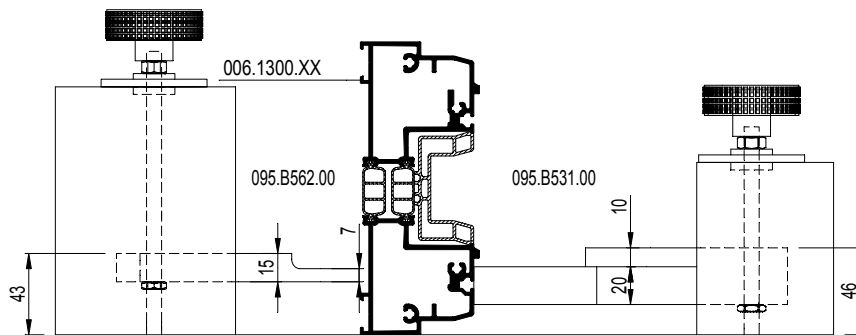

Pershoeken

VOLGORDE

1. Correct zagen
2. Ontbramen (indien noodzakelijk)
3. Stof en zaagresten verwijderen
4. Ontvetten met Reynafinish 60, art. nr. 086.9210.--
5. Reynaprotector aanbrengen, art. nr. 086.9208.-- + 086.9225.--
6. Verlijmen in de profielkamer door middel van reynaseal duo, art. nr. 084.9080.--
7. Verbinding tot stand brengen en persen
8. Zichtvlakken reinigen met Reynafinish 60 art.nr. 086.9210.--

Equerres à sertir

ORDRE

1. Tronçonnage correct
2. Ebavurage (si nécessaire)
3. Enlèvement de poussières et de copeaux de sciage
4. Dégraissage avec Reynafinish 60, art. nr. 086.9210.--
5. Application de Reynaprotector, art. nr. 086.9208.-- + 086.9225.--
6. Encollage dans la chambre du profilé au moyen de reynaseal duo, art. n° 084.9080.--
7. Assemblage et sertissage
8. Nettoyage des surfaces visibles au moyen de Reynafinish 60 art.nr. 086.9210.--

Crimp corner cleats

SEQUENCE

1. Correct sawing
2. Deburring (if necessary)
3. Removing dust and saw-dust
4. Degreasing with Reynafinish 60, art. nr. 086.9210.--
5. Applying Reynaprotector, art. nr. 086.9208.-- + 086.9225.--
6. Glueing in the profile chamber by means of reynaseal duo, art. no. 084.9080.--
7. Assembly and crimping
8. Cleaning visible surfaces by means of Reynafinish 60 art.nr. 086.9210.--

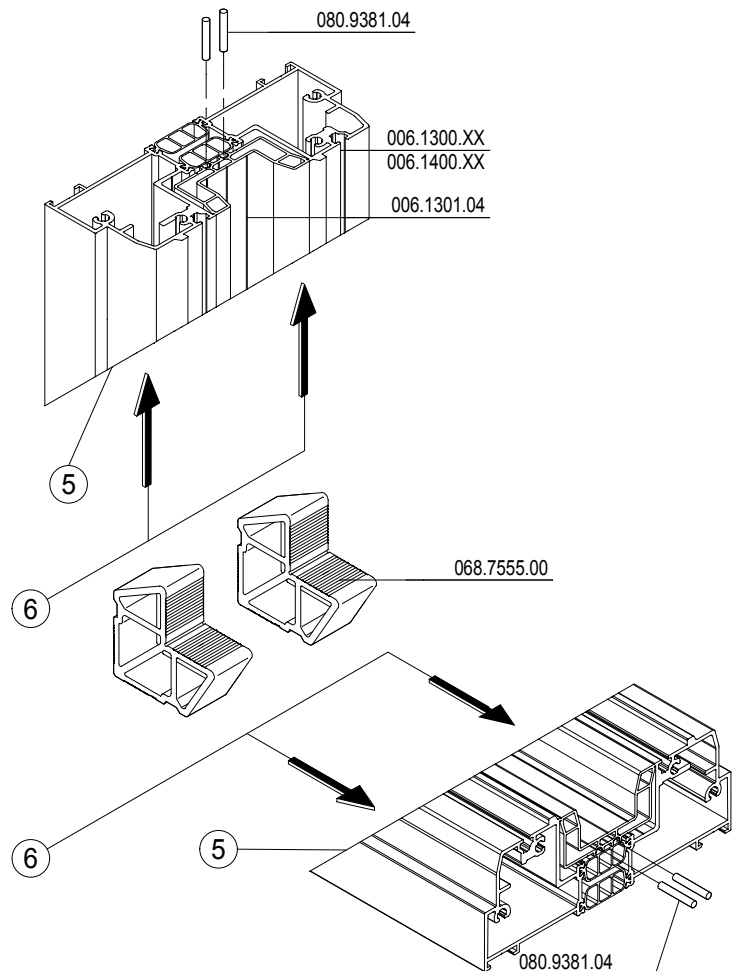

Presseckwinkel

REIHENFOLGE

1. Zuschneiden
2. Entgraten (falls erforderlich)
3. Staub und Sägereste entfernen
4. Entfetten mit Reynafinish 60, art. nr. 086.9210.--
5. Reynaprotector aufbringen, Art. Nr. 086.9208.-- + 086.9225.--
6. Klebereinsatz in die Eckwinkelkammer mit reynaseal duo, Art. nr. 084.9080.--
7. Verbinden und verpressen
8. Die Sichtseiten säubern mit Reynafinish 60 art.nr. 086.9210.--

MONTAGEVOLGORDE	1	2	3	.
L'ORDRE DE MONTAGE				
THE ORDER OF ASSEMBLY				
MONTAGEREIHENFOLGE				

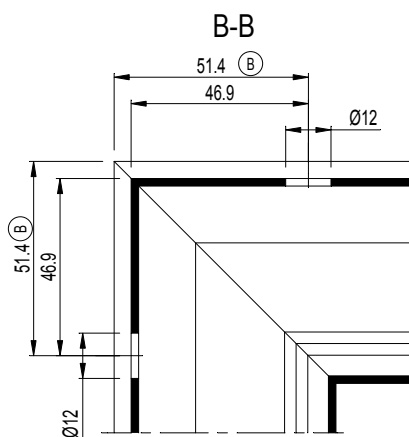
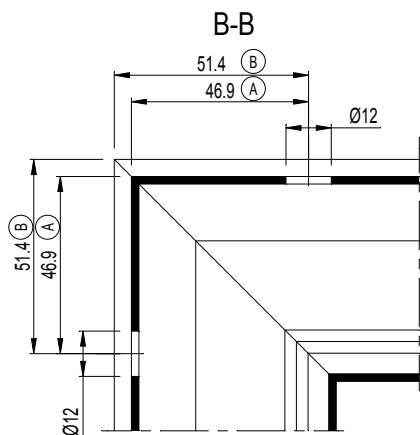
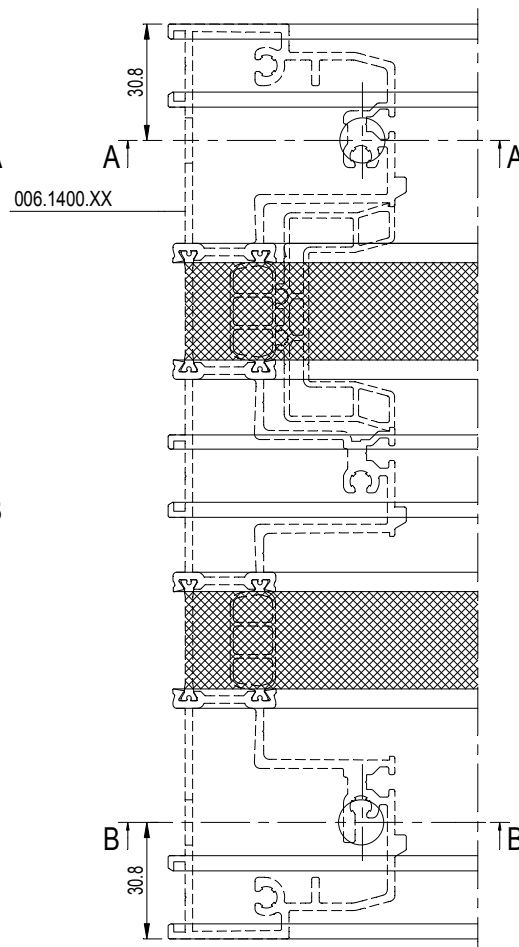
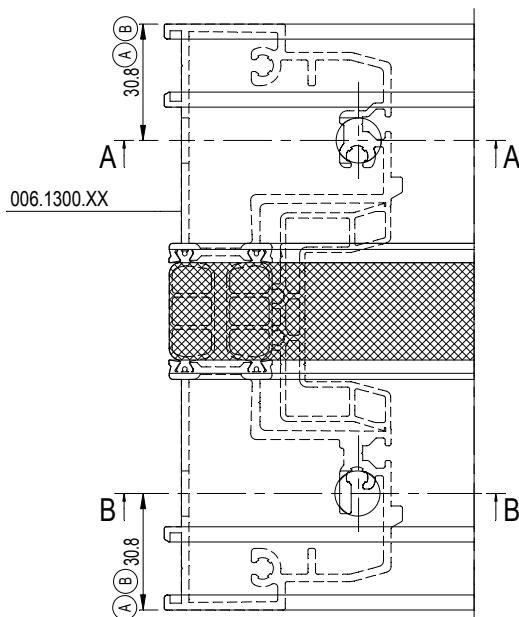
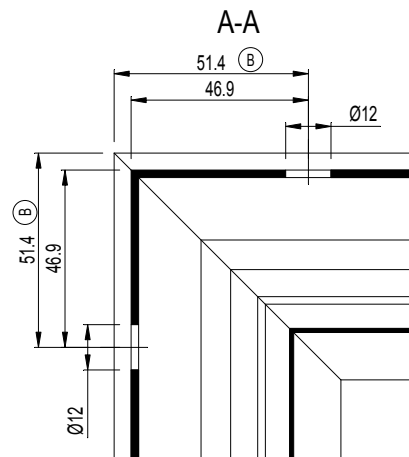
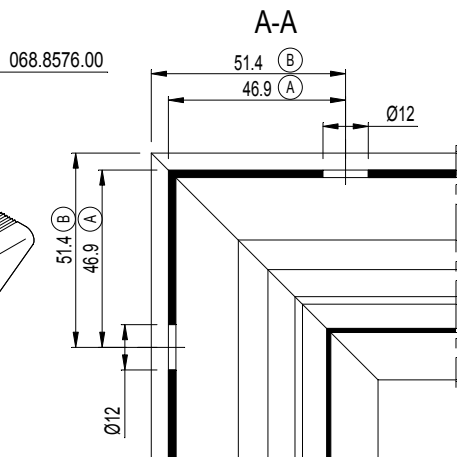
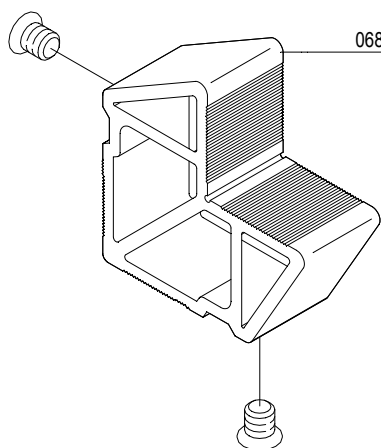

(A)		097.0440.00
(B)		SBZ 122 SBZ 140

Schroefhoeken

VOLGORDE

1. Correct zagen
2. Ontbramen (indien noodzakelijk)
3. Stof en zaagresten verwijderen
4. Ontvetten met Reynafinish 60, art. nr. 086.9210.--
5. Reynaprotector aanbrengen, art. nr. 086.9208.-- + 086.9225.--
6. Verlijmen in de profielkamer door middel van reynaseal duo, art. nr. 084.9080.--
7. Verbinding tot stand brengen en schroeven
8. Zichtvlakken reinigen met Reynafinish 60 art.nr. 086.9210.--

Equerres à blocage

ORDRE

1. Tronçonnage correct
2. Ebavurage (si nécessaire)
3. Enlèvement de poussières et de copeaux de sciage
4. Dégraissage avec Reynafinish 60, art. nr. 086.9210.--
5. Application de Reynaprotector, art. nr. 086.9208.-- + 086.9225.--
6. Encollage dans la chambre du profilé au moyen de reynaseal duo, art. n° 084.9080.--
7. Assemblage et vissage
8. Nettoyage des surfaces visibles au moyen de Reynafinish 60 art.nr. 086.9210.--

Screw corner cleats

SEQUENCE

1. Correct sawing
2. Deburring (if necessary)
3. Removing dust and saw-dust
4. Degreasing with Reynafinish 60, art. nr. 086.9210.--
5. Applying Reynaprotector, art. nr 086.9208.-- + 086.9225.--
6. Glueing in the profile chamber by means of reynaprotector, art. no. 084.9080.--
7. Assembly and screwing
8. Cleaning visible surfaces by means of Reynafinish 60 art.nr. 086.9210.--

Schraubeckwinkel

REIHENFOLGE

1. Zuschneiden
2. Entgraten (falls erforderlich)
3. Staub und Sägereste entfernen
4. Entfetten mit Reynafinish 60, art. nr. 086.9210.--
5. Reynaprotector aufbringen, Art. Nr. 086.9208.-- + 086.9225.--
6. Klebereinsatz in die Eckwinkelkammer mit Zweikomponentenkleber, Art. nr. 084.9080.--
7. Verbinden und verschrauben
8. Die Sichtseiten säubern mit Reynafinish 60 art.nr. 086.9210.--

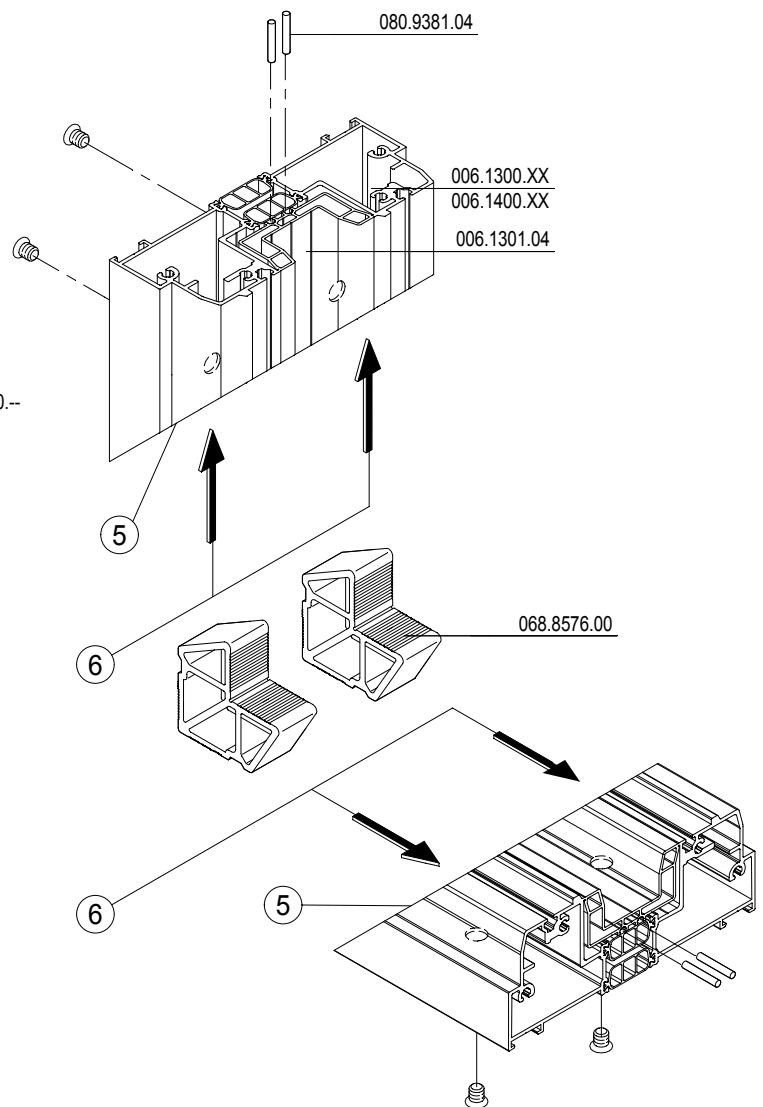

MONTAGEVOLGORDE
L'ORDRE DE MONTAGE
THE ORDER OF ASSEMBLY
MONTAGEREIHENFOLGE

1	2	3	.
---	---	---	---

095.H800.00

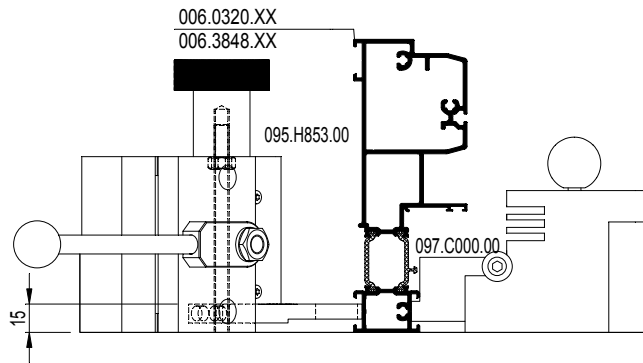
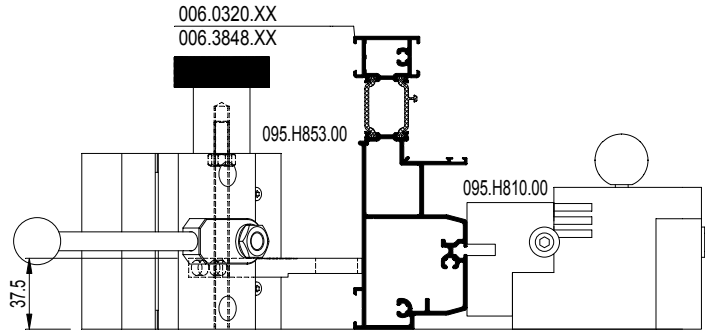

095.B500.00

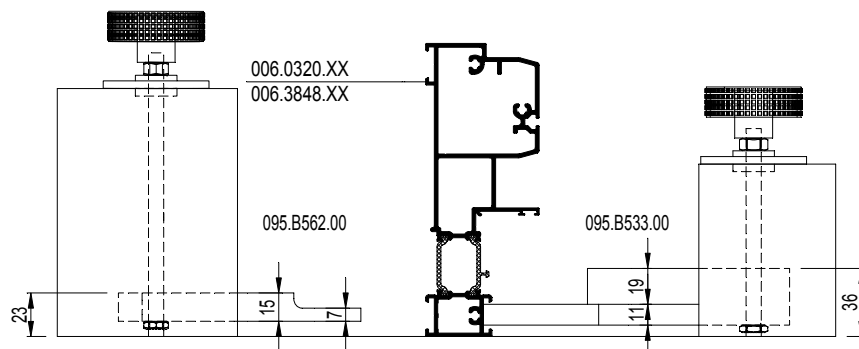
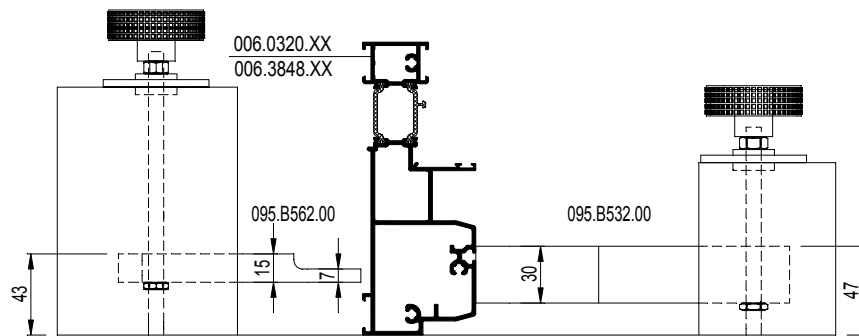

D0013953

Pershoeken

VOLGORDE

1. Correct zagen
2. Ontbramen (indien noodzakelijk)
3. Stof en zaagresten verwijderen
4. Ontvetten met Reynafinish 60, art. nr. 086.9210.--
5. Reynaprotector aanbrengen, art. nr. 086.9208.-- + 086.9225.--
6. Verlijmen: - in de profielkamer
 - op de plaats waar de steunhoek komt
 door middel van reynaseal duo, art. nr. 084.9080.--
7. Verbinding tot stand brengen en persen
8. Zichtvlakken reinigen met Reynafinish 60 art.nr. 086.9210.--

Equerres à sertir

ORDRE

1. Tronçonnage correct
2. Ebavurage (si nécessaire)
3. Enlèvement de poussières et de copeaux de sciage
4. Dégraissage avec Reynafinish 60, art. nr. 086.9210.--
5. Application de Reynaprotector, art. nr. 086.9208.-- + 086.9225.--
6. Encollage: - dans la rainure destinée à la cale de feuillure
 - dans la rainure destinée à la cale de feuillure
 au moyen de reynaseal duo, art. n° 084.9080.--
7. Assemblage et sertissage
8. Nettoyage des surfaces visibles au moyen de Reynafinish 60 art.nr. 086.9210.--

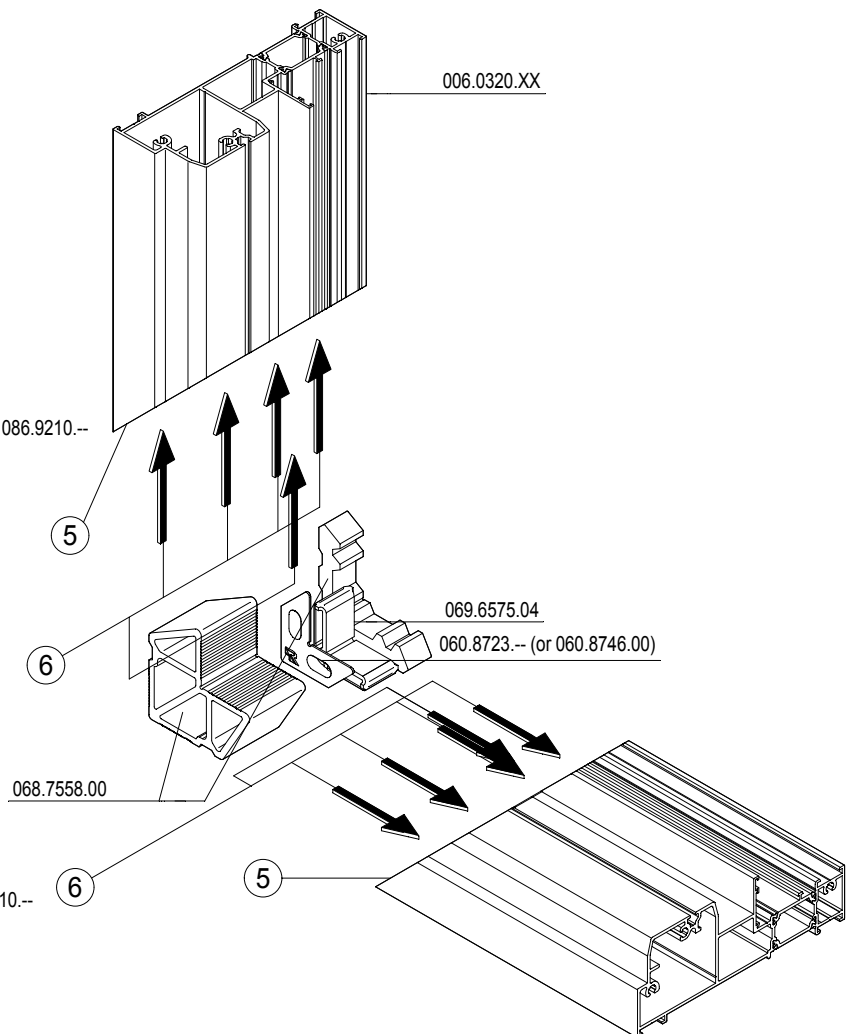

Crimp corner cleats

SEQUENCE

1. Correct sawing
2. Deburring (if necessary)
3. Removing dust and saw-dust
4. Degreasing with Reynafinish 60, art. nr. 086.9210.--
5. Applying Reynaprotector, art. nr. 086.9208.-- + 086.9225.--
6. Gluing: - in the profile chamber
 - in the area where the rebate support will be inserted
 by means of reynaseal duo, art. no. 084.9080.--
7. Assembly and crimping
8. Cleaning visible surfaces by means of Reynafinish 60 art.nr. 086.9210.--

Presseckwinkel

REIHENFOLGE

1. Zuschneiden
2. Entgraten (falls erforderlich)
3. Staub und Sägereste entfernen
4. Entfetten mit Reynafinish 60, art. nr. 086.9210.--
5. Reynaprotector aufbringen, Art. Nr. 086.9208.-- + 086.9225.--
6. Klebereinsatz: - in die Eckwinkelkammer
 - im Bereich des Glasanschlagwinkels
 mit reynaseal duo, Art. nr. 084.9080.--
7. Verbinden und verpressen
8. Die Sichtseiten säubern mit Reynafinish 60 art.nr. 086.9210.--

MONTAGEVOLGORDE
 L'ORDRE DE MONTAGE
 THE ORDER OF ASSEMBLY
 MONTAGEREIHENFOLGE

1	2	3	.
---	---	---	---

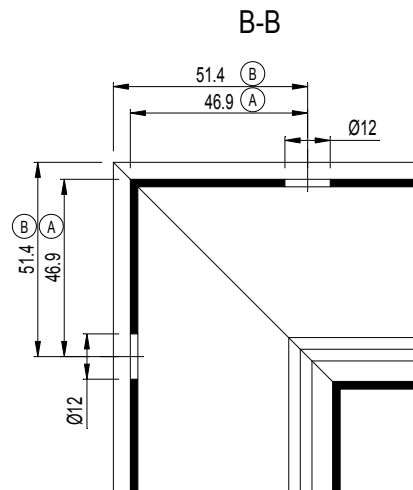
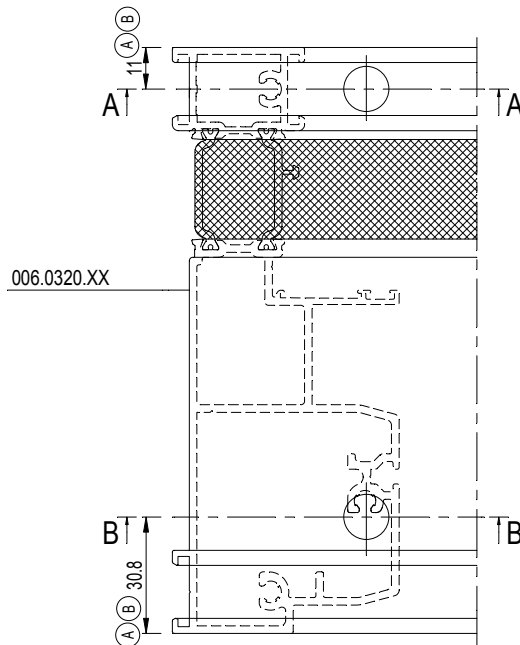
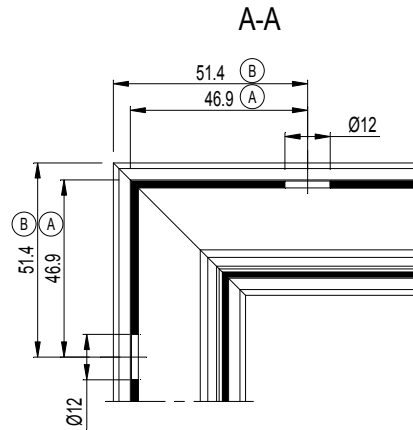
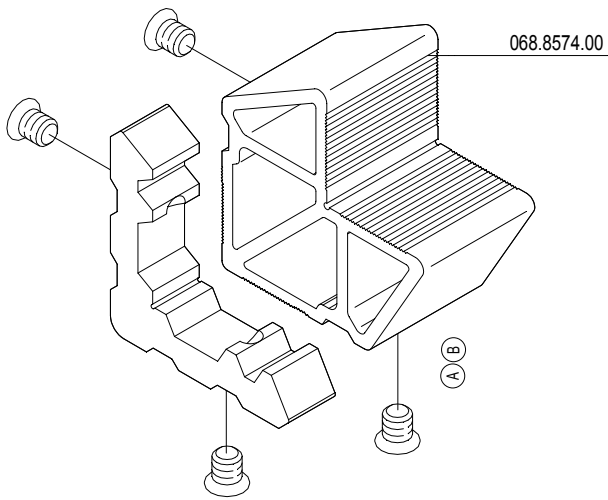

(A)		097.0440.00
(B)		SBZ 122 SBZ 140

Schroefhoeken

VOLGORDE

1. Correct zagen
2. Ontbramen (indien noodzakelijk)
3. Stof en zaagresten verwijderen
4. Ontvetten met Reynafinish 60, art. nr. 086.9210.--
5. Reynaprotector aanbrengen, art. nr. 086.9208.-- + 086.9225.--
6. Verlijmen: - in de profielkamer
 - op de plaats waar de steunhoek komt
 door middel van reynaseal duo, art. nr. 084.9080.--
7. Verbinding tot stand brengen en schroeven
8. Zichtvlakken reinigen met Reynafinish 60 art.nr. 086.9210.--

Equerres à blocage

ORDRE

1. Tronçonnage correct
2. Ebavurage (si nécessaire)
3. Enlèvement de poussières et de copeaux de sciage
4. Dégraissage avec Reynafinish 60, art. nr. 086.9210.--
5. Application de Reynaprotector, art. nr. 086.9208.-- + 086.9225.--
6. Encollage: - dans la chambre du profilé
 - dans la rainure destinée à la cale de feuillure
 au moyen de colle bicomposants, art. n° 084.9080.--
7. Nettoyage des surfaces visibles au moyen de Reynafinish 60 art.nr. 086.9210.--
8. Assemblage et vissage

Screw corner cleats

SEQUENCE

1. Correct sawing
2. Deburring (if necessary)
3. Removing dust and saw-dust
4. Degreasing with Reynafinish 60, art. nr. 086.9210.--
5. Applying Reynaprotector, art. nr 086.9208.-- + 086.9225.--
6. Glueing: - in the profile chamber
 - in the area where the rebate support will be inserted
 by means of glue for corner connections, art. no. 084.9080.--
7. Assembly and screwing
8. Cleaning visible surfaces by means of Reynafinish 60 art.nr. 086.9210.--

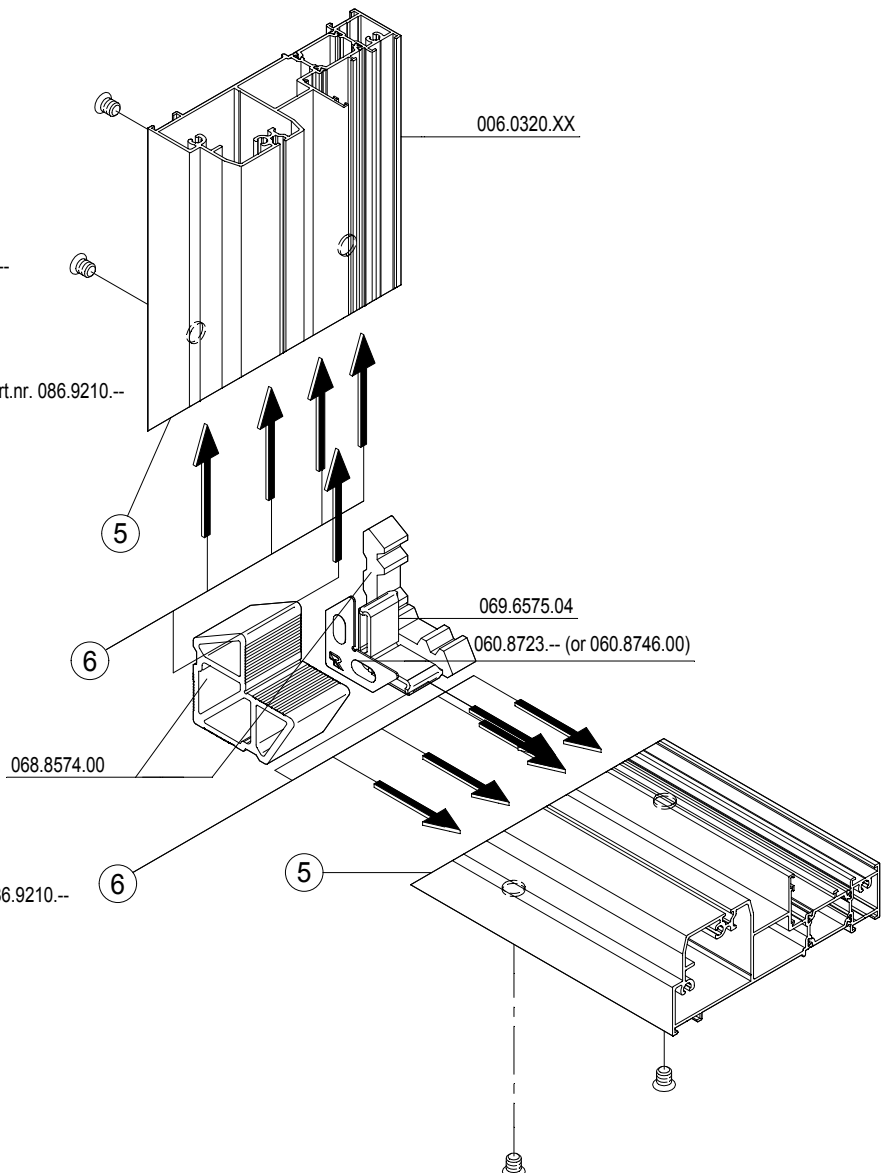

Schraubeckwinkel

REIHENFOLGE

1. Zuschneiden
2. Entgraten (falls erforderlich)
3. Staub und Sägereste entfernen
4. Entfetten mit Reynafinish 60, art. nr. 086.9210.--
5. Reynaprotector aufbringen, Art. Nr. 086.9208.-- + 086.9225.--
6. Klebereinsatz: - in die Eckwinkelkammer
 - im Bereich des Glasanschlagwinkels
 mit Zweikomponentenkleber, Art. nr. 084.9080.--
7. Verbinden und verschrauben
8. Die Sichtseiten säubern mit Reynafinish 60 art.nr. 086.9210.--

MONTAGEVOLGORDE				
L'ORDRE DE MONTAGE				
THE ORDER OF ASSEMBLY				
MONTAGEREIHENFOLGE	1	2	3	.

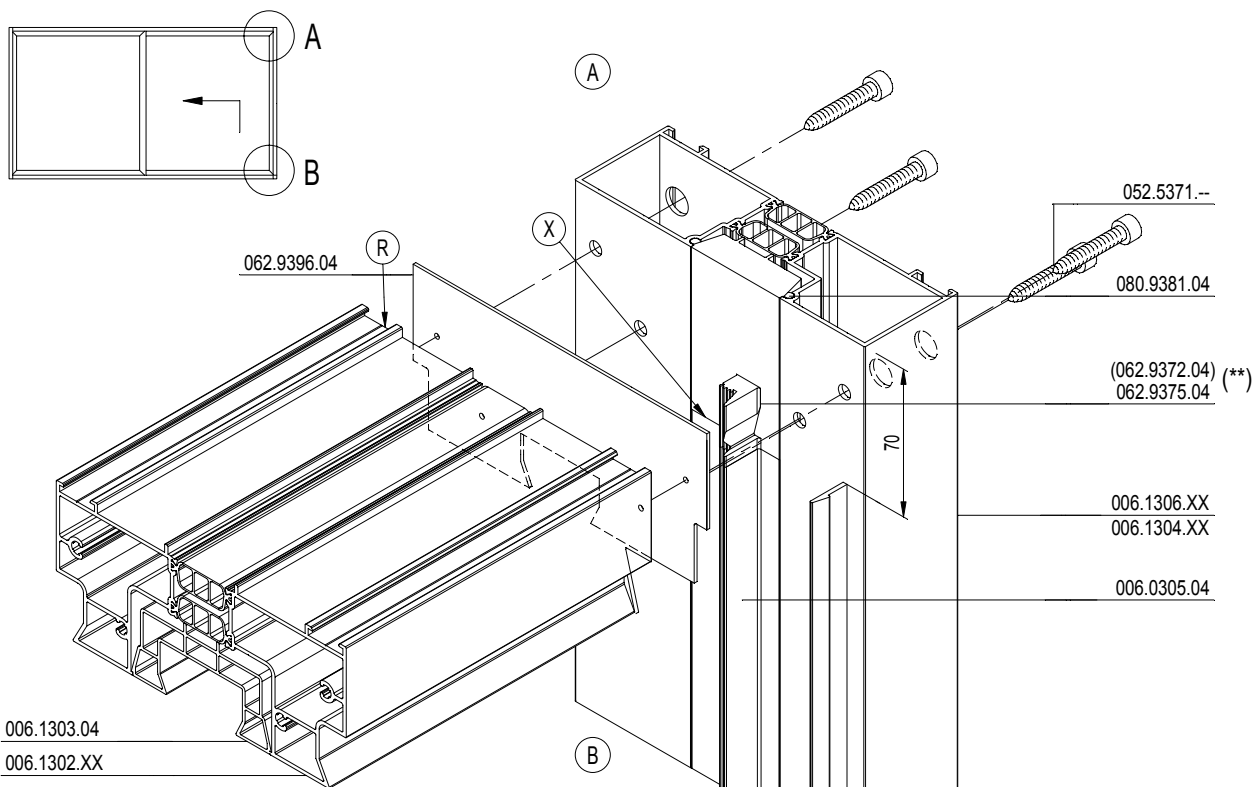

006.1303.04
 006.1302.XX

052.5371.--

080.9381.04

(062.9372.04) (**)
 062.9375.04

006.1306.XX
 006.1304.XX

006.0305.04

Afhankelijk van de positie van de primaire vleugel
 (***) Dépend de la position de ouvrante principale
 depending on the position of the primary vent
 abhängig von der Position des primären Flügel

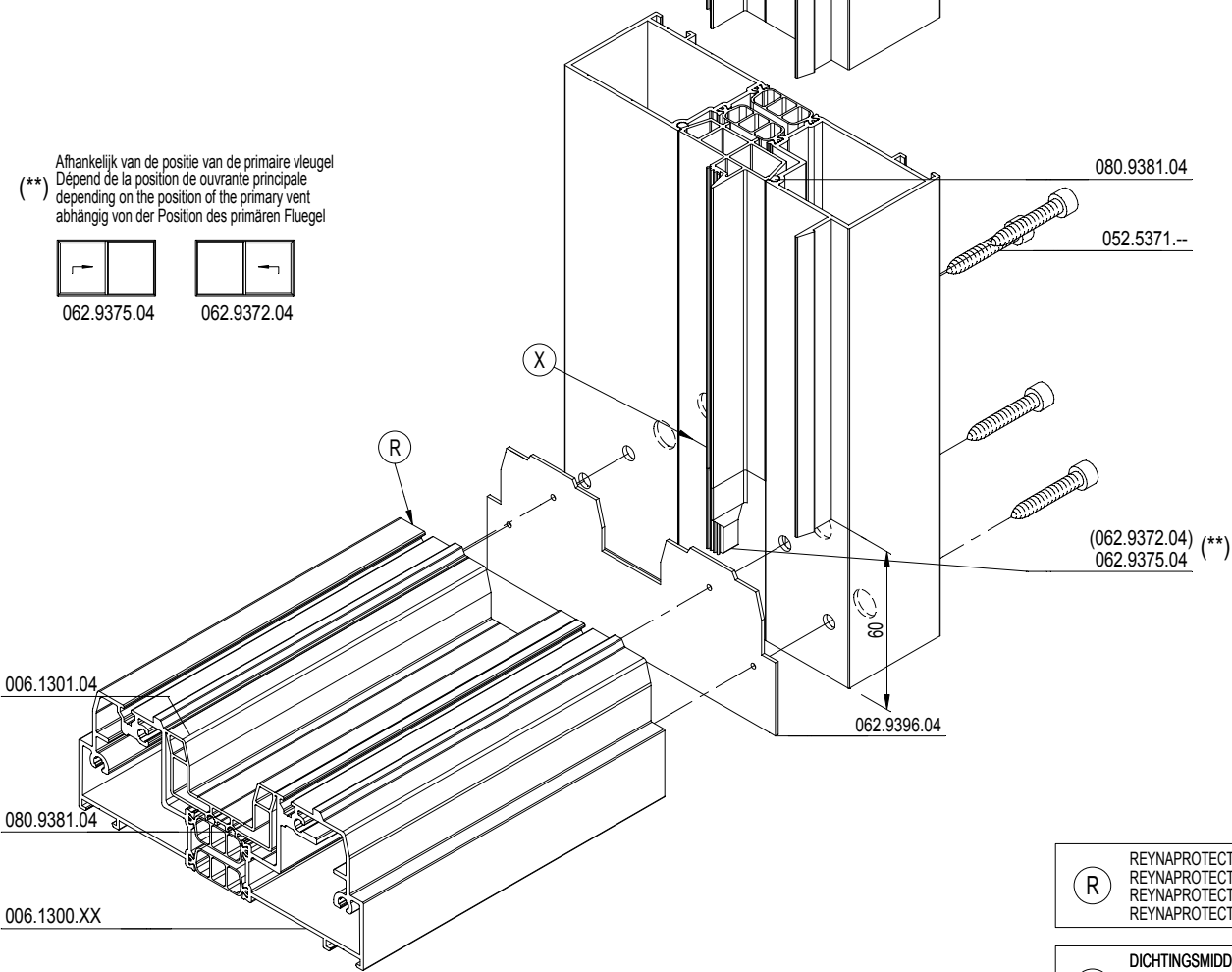
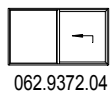
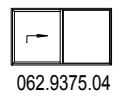

080.9381.04

052.5371.--

(062.9372.04) (**)
 062.9375.04

062.9396.04

006.1301.04

080.9381.04

006.1300.XX

(R) REYNAPROTECTOR
 REYNAPROTECTOR
 REYNAPROTECTOR
 REYNAPROTECTOR

(X) DICHTINGSMIDDEL
 MATIERE D'ETANCHEITE
 SEALING AGENT
 ABDICHTUNG

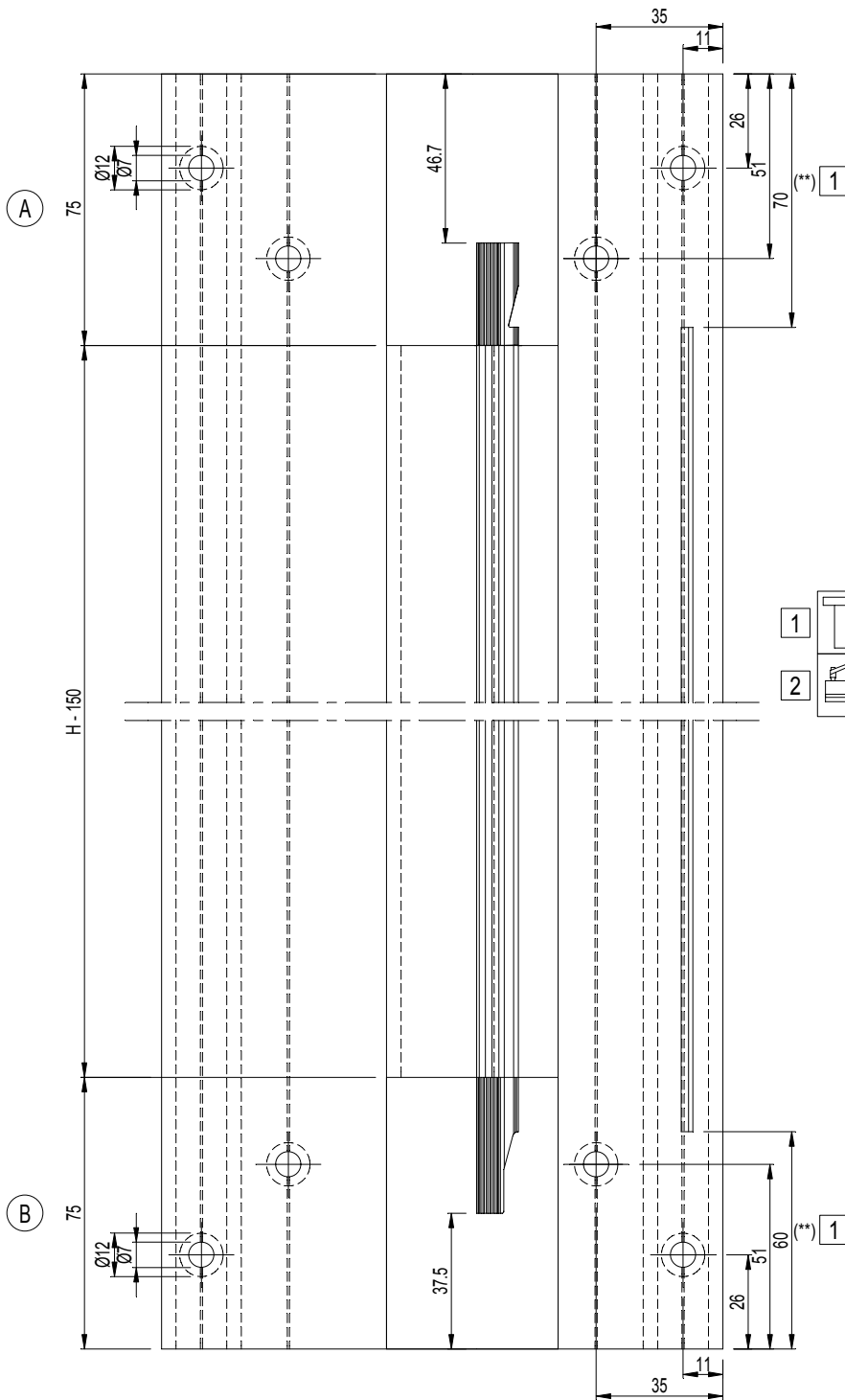

1		097.0183.00		097.L700.00 (**)
2		097.0014.00		(*)(Ø7)

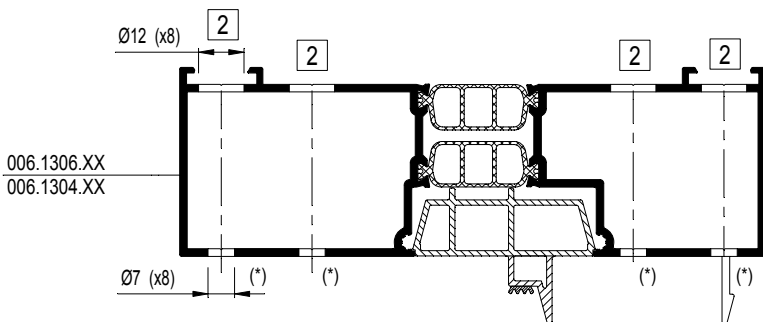

MONTAGEVOLGORDE L'ORDRE DE MONTAGE THE ORDER OF ASSEMBLY MONTAGEREIHENFOLGE	1	2	3	.
--	---	---	---	---

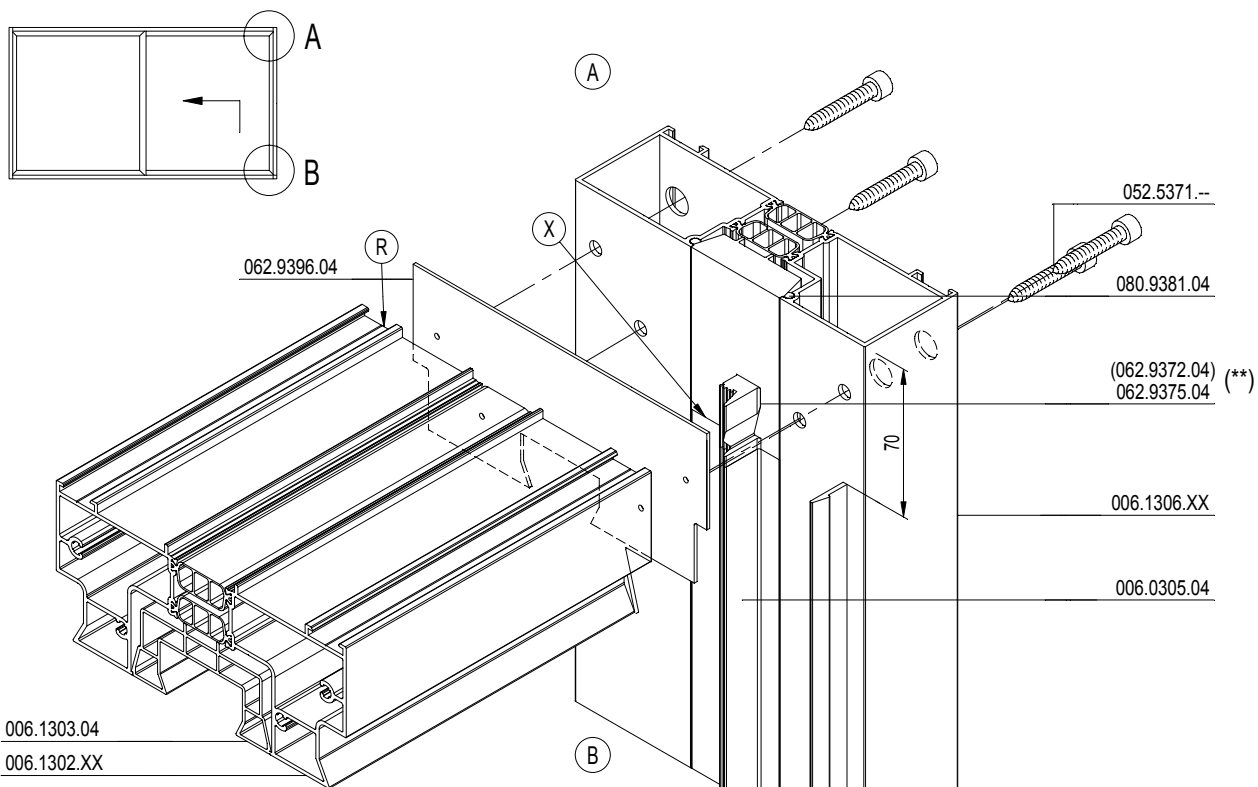

(**) Afhankelijk van de positie van de primaire vleugel
 Dépend de la position de ouvrante principale
 depending on the position of the primary vent
 abhängig von der Position des primären Flügels

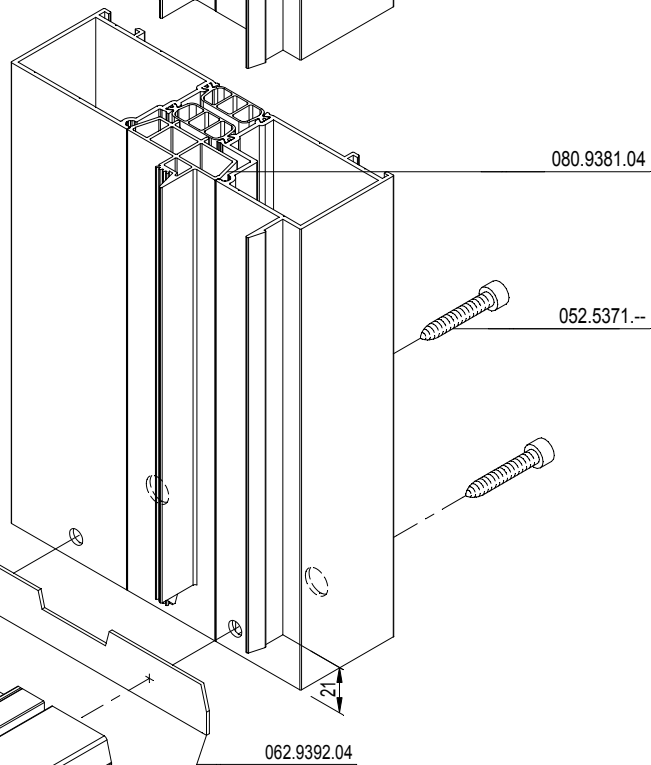
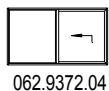
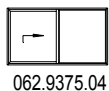

- 006.0317.XX
- 007.0767.01
- 080.9441.04
- 006.0318.XX

(R) REYNAPROTECTOR
 REYNAPROTECTOR
 REYNAPROTECTOR
 REYNAPROTECTOR

(X) DICHTINGSMIDDEL
 MATIERE D'ETANCHEITE
 SEALING AGENT
 ABDICHTUNG

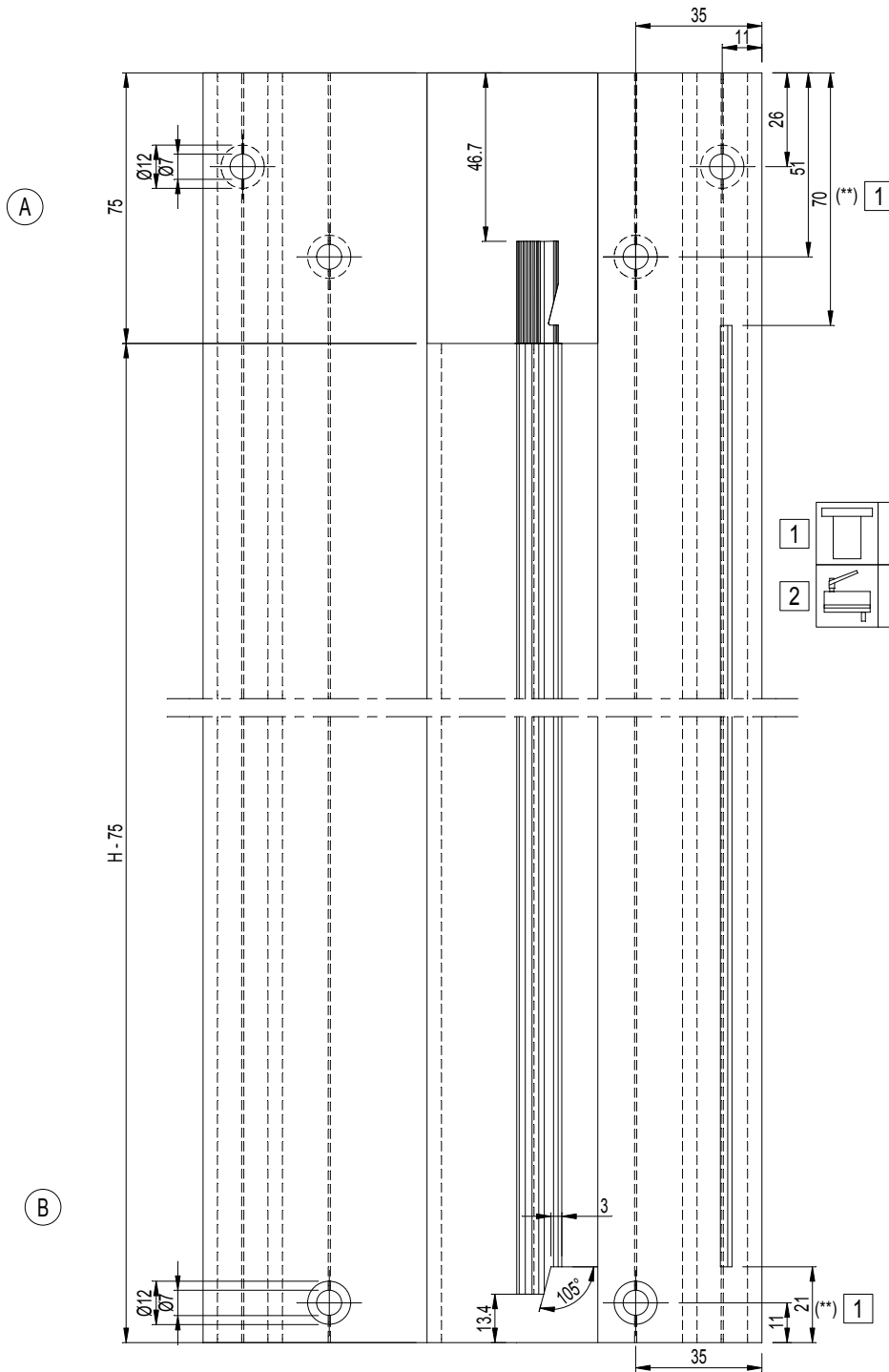

1		097.0183.00		097.L700.00 (**)
2		097.0014.00		(*)(Ø7)

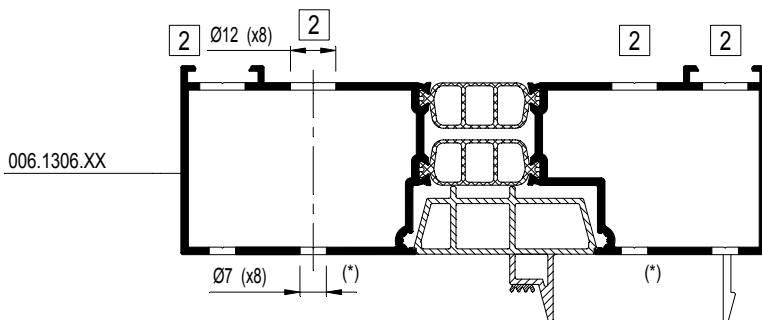

MONTAGEVOLGORDE L'ORDRE DE MONTAGE THE ORDER OF ASSEMBLY MONTAGEREIHENFOLGE	1	2	3	.
--	---	---	---	---

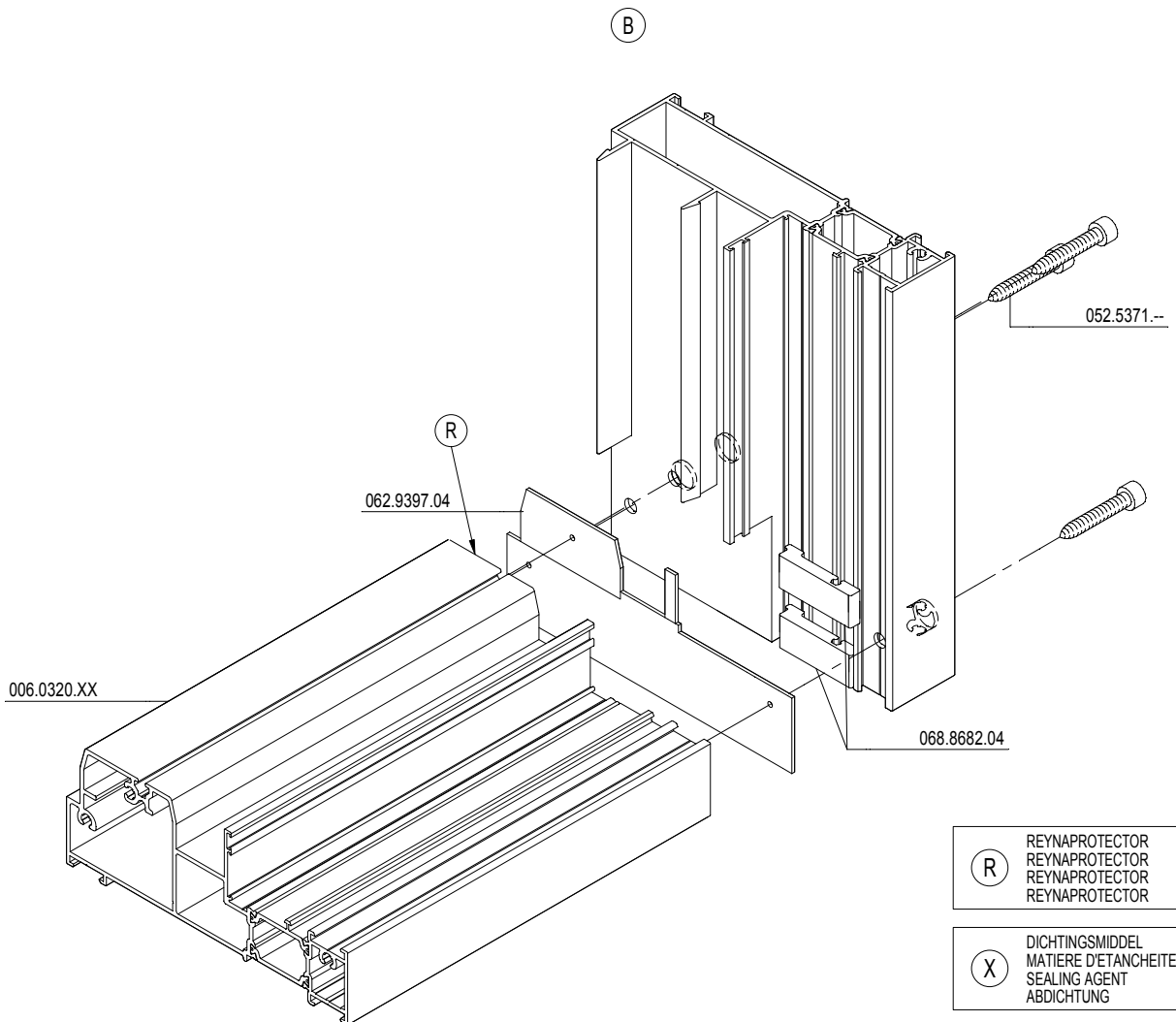
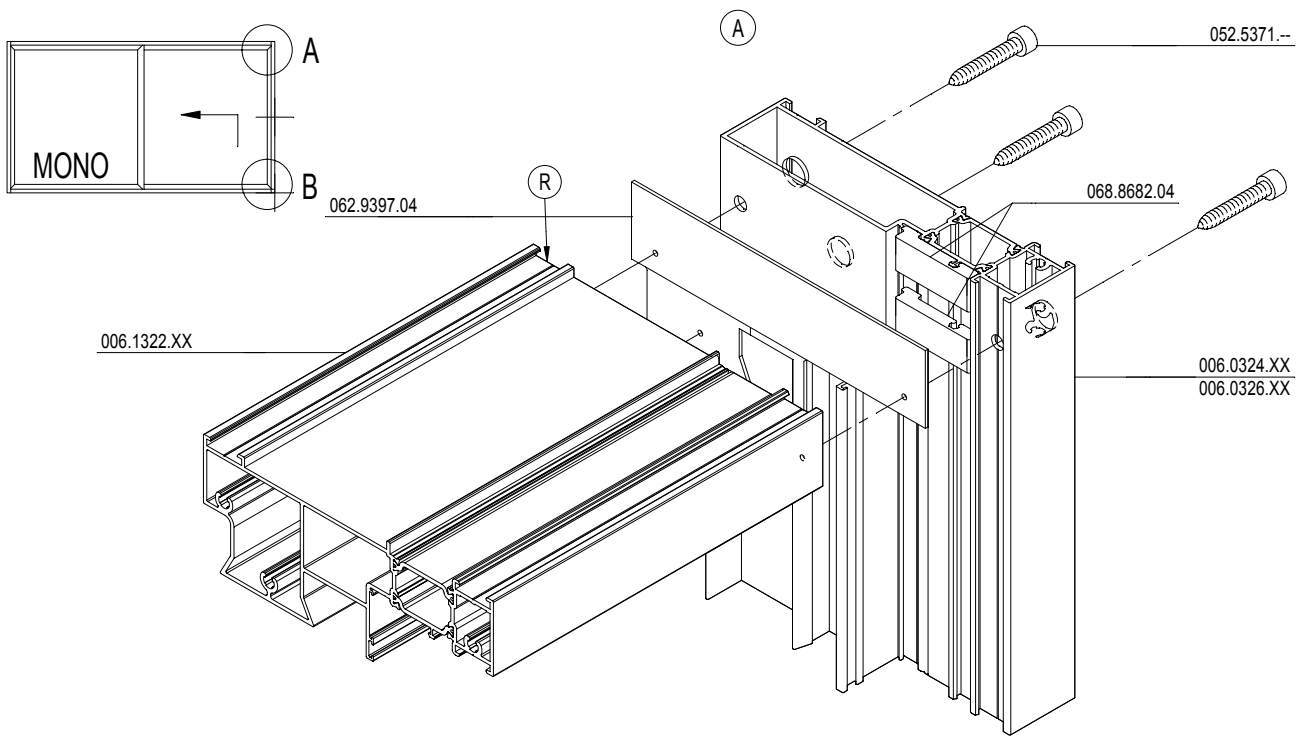

D0013956

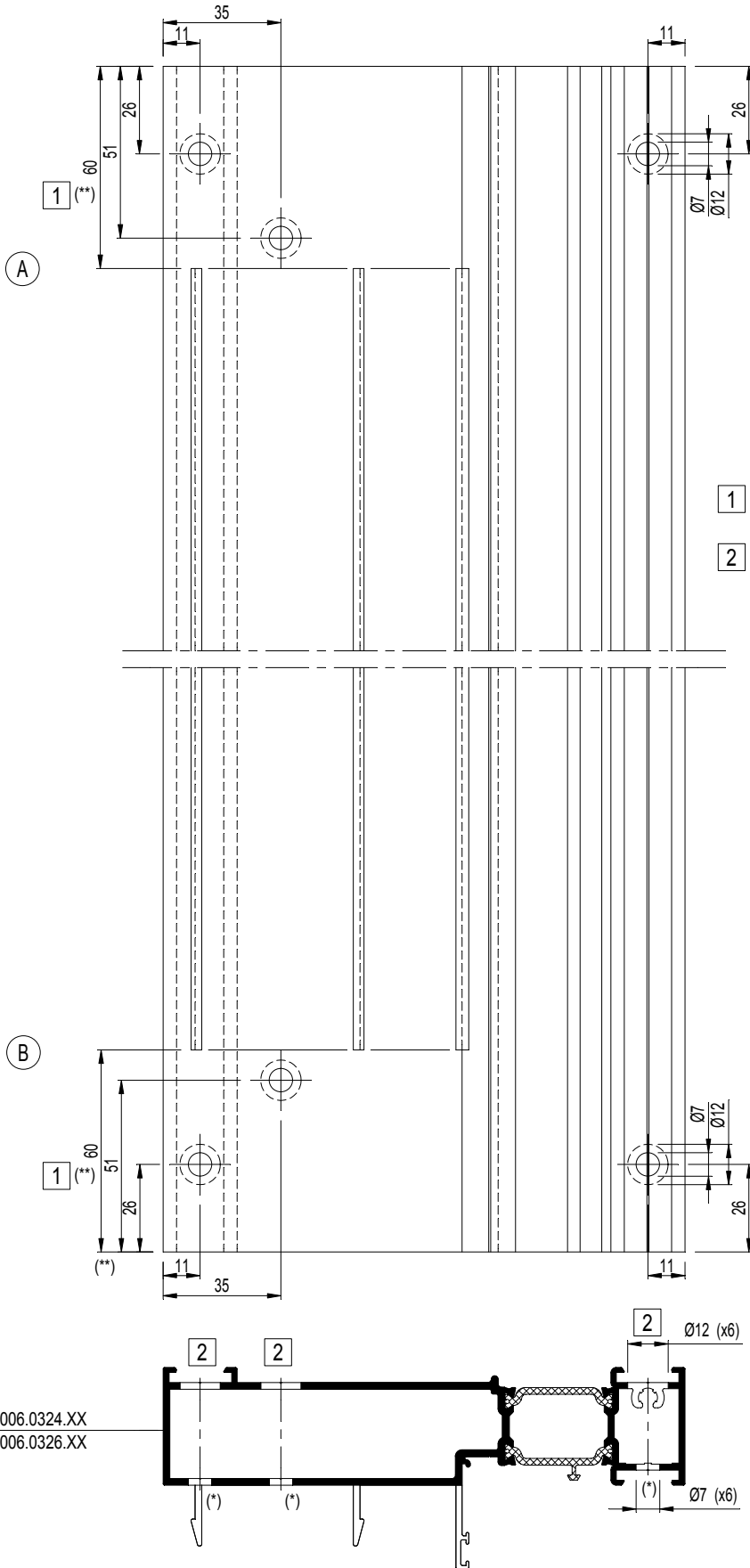

1		097.0183.00		097.L700.00 (**)
2		097.0014.00		(*)(Ø7)

MONTAGEVOLGORDE L'ORDRE DE MONTAGE THE ORDER OF ASSEMBLY MONTAGEREIHENFOLGE	1	2	3	.
--	---	---	---	---

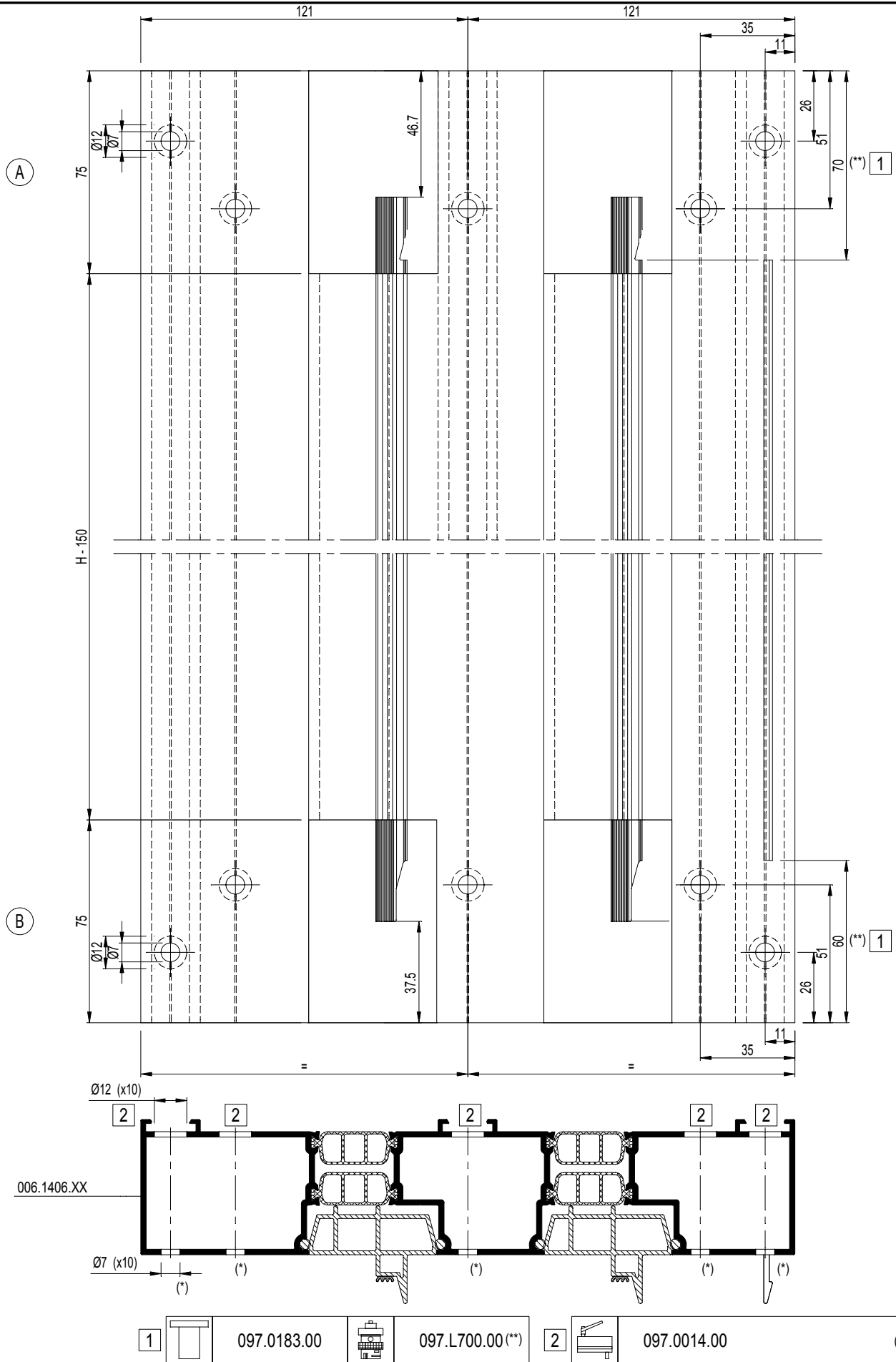

1		097.0183.00		097.L700.00 (**)	2		097.0014.00	(*) ($\varnothing 7$)
---	--	-------------	--	------------------	---	--	-------------	-------------------------

CP 155-LS/HI MINERGIE LABEL

MONTAGE BUITENKADER
ASSEMBLAGE DORMANT
ASSEMBLY OUTER FRAME
MONTAGE BLENDRAHMEN

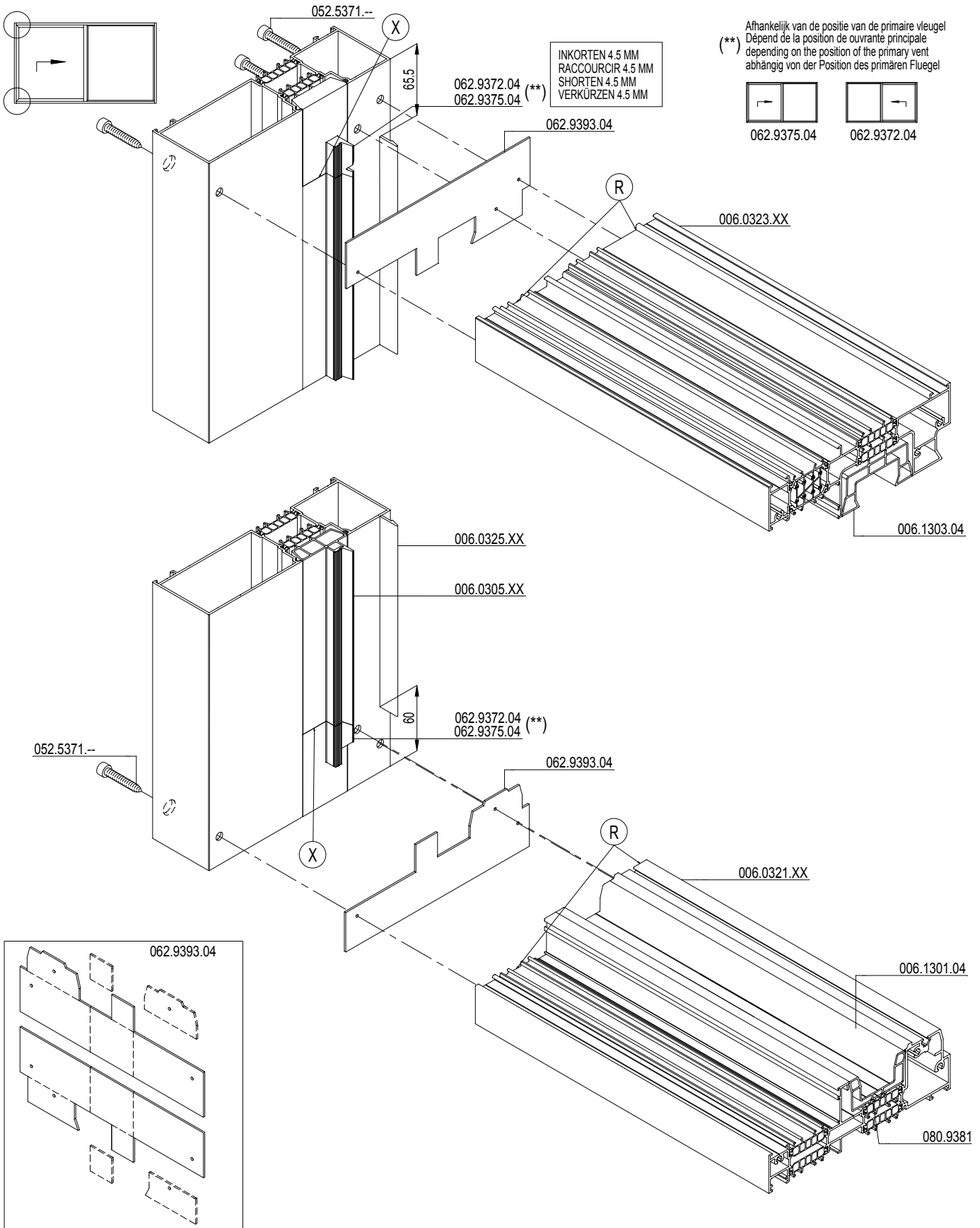

(X) DICHTINGSMIDDEL
MATIERE D'ETANCHEITE
SEALING AGENT
ABDICHTUNG

(R) REYNAPROTECTOR
REYNAPROTECTOR
REYNAPROTECTOR
REYNAPROTECTOR

CP 155-LS/HI MINERGIE LABEL

MONTAGE BUITENKADER
ASSEMBLAGE DORMANT
ASSEMBLY OUTER FRAME
MONTAGE BLENDRAHMEN

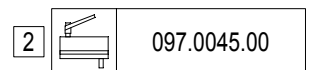
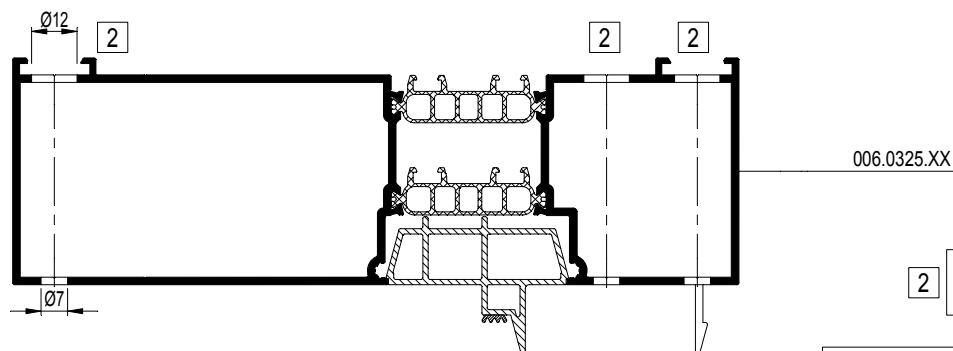
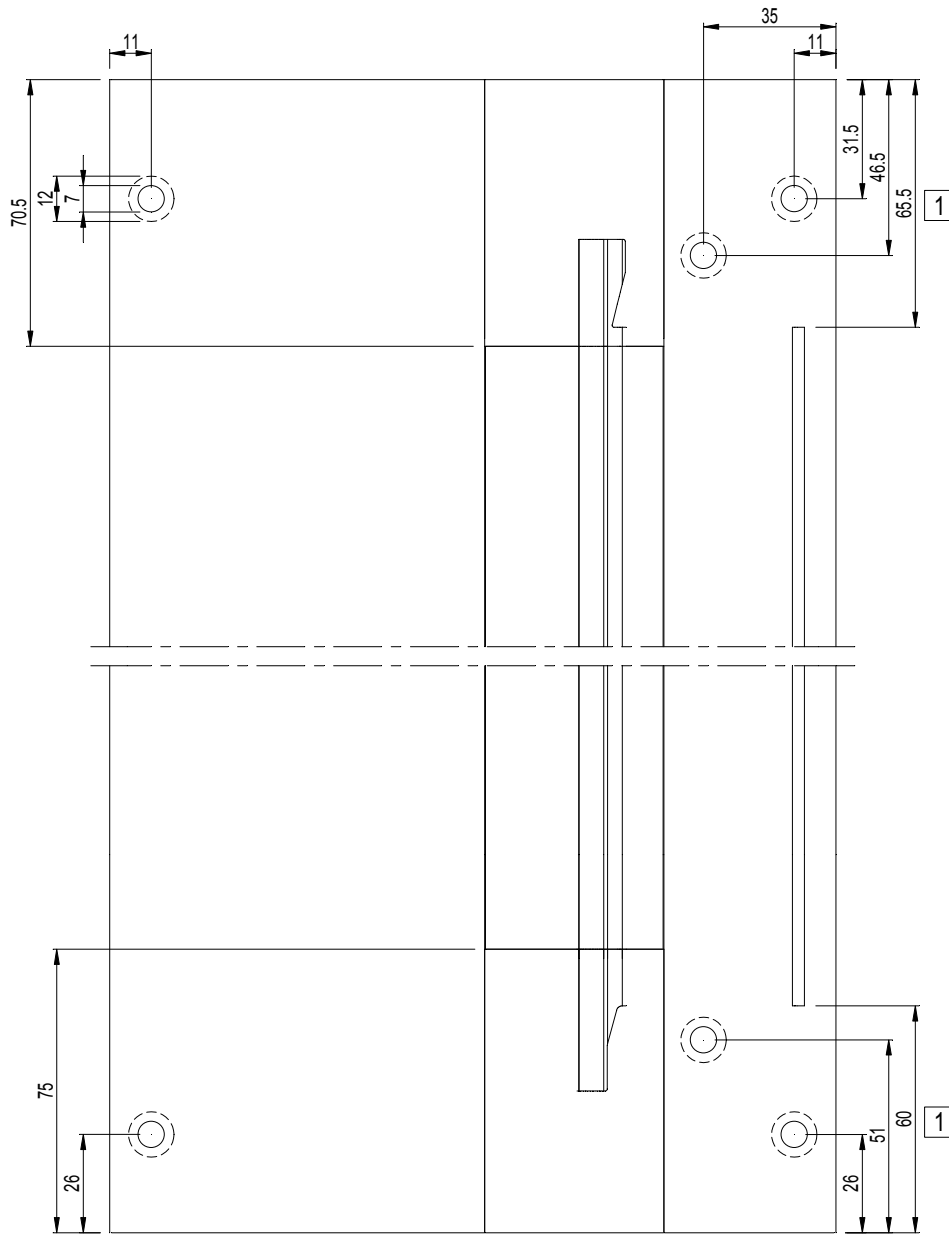

MONTAGEVOLGORDE L'ORDRE DE MONTAGE THE ORDER OF ASSEMBLY MONTAGEREIHENFOLGE	1	2	3	.
--	---	---	---	---

CP 155-LS/HI MINERGIE LABEL

MONTAGE BUITENKADER
ASSEMBLAGE DORMANT
ASSEMBLY OUTER FRAME
MONTAGE BLENDRAHMEN

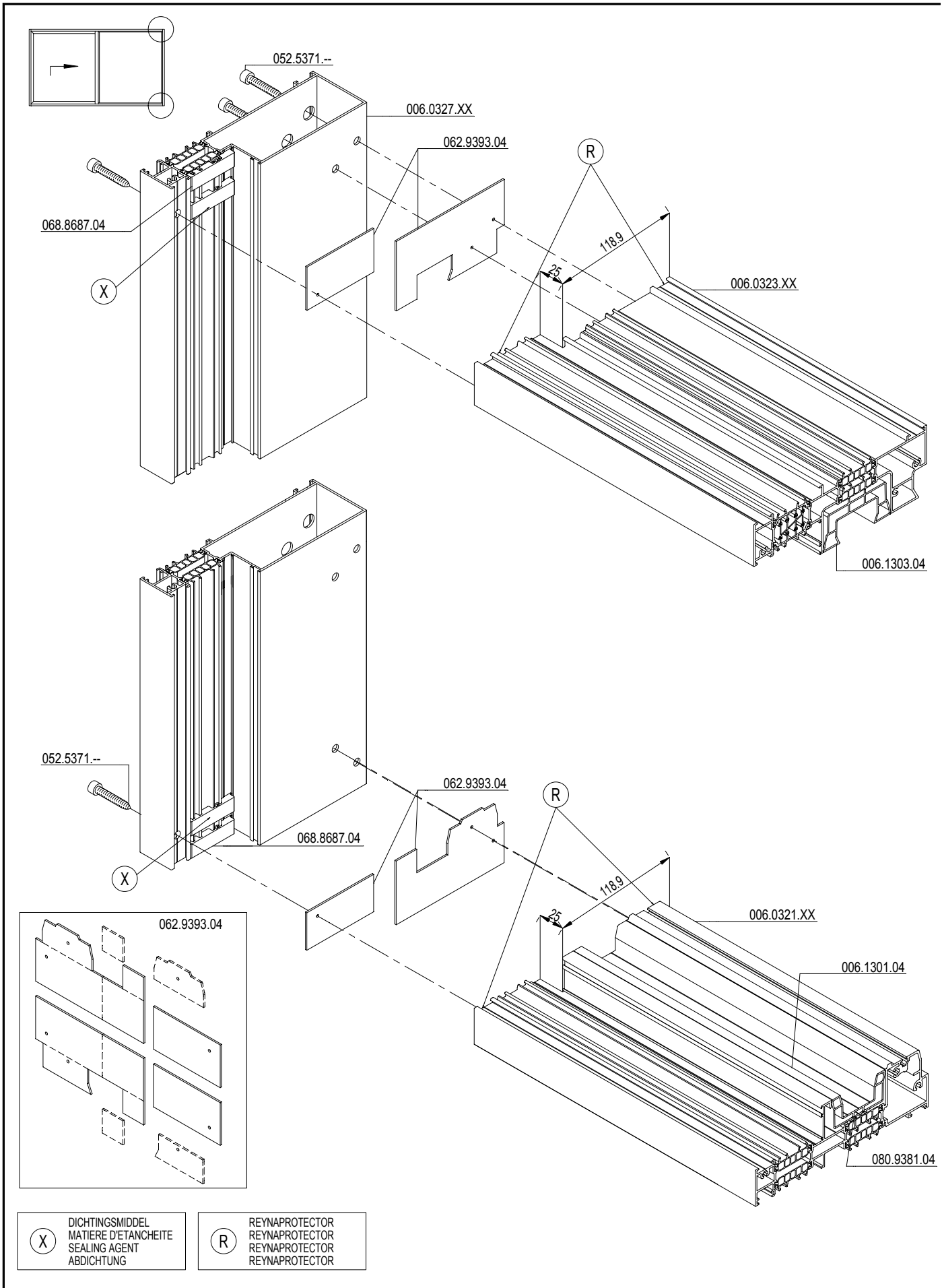

(X) DICHTINGSMIDDEL
MATIERE D'ETANCHEITE
SEALING AGENT
ABDICHTUNG

(R) REYNAPROTECTOR
REYNAPROTECTOR
REYNAPROTECTOR
REYNAPROTECTOR

CP 155-LS/HI MINERGIE LABEL

MONTAGE BUITENKADER
ASSEMBLAGE DORMANT
ASSEMBLY OUTER FRAME
MONTAGE BLENDRAHMEN

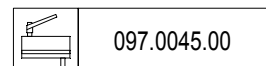
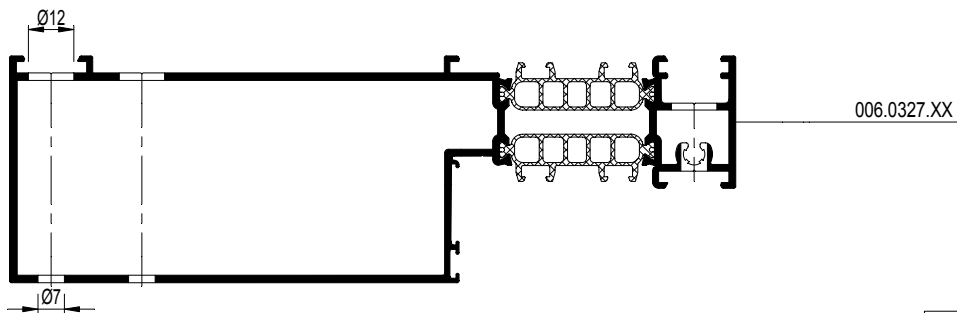
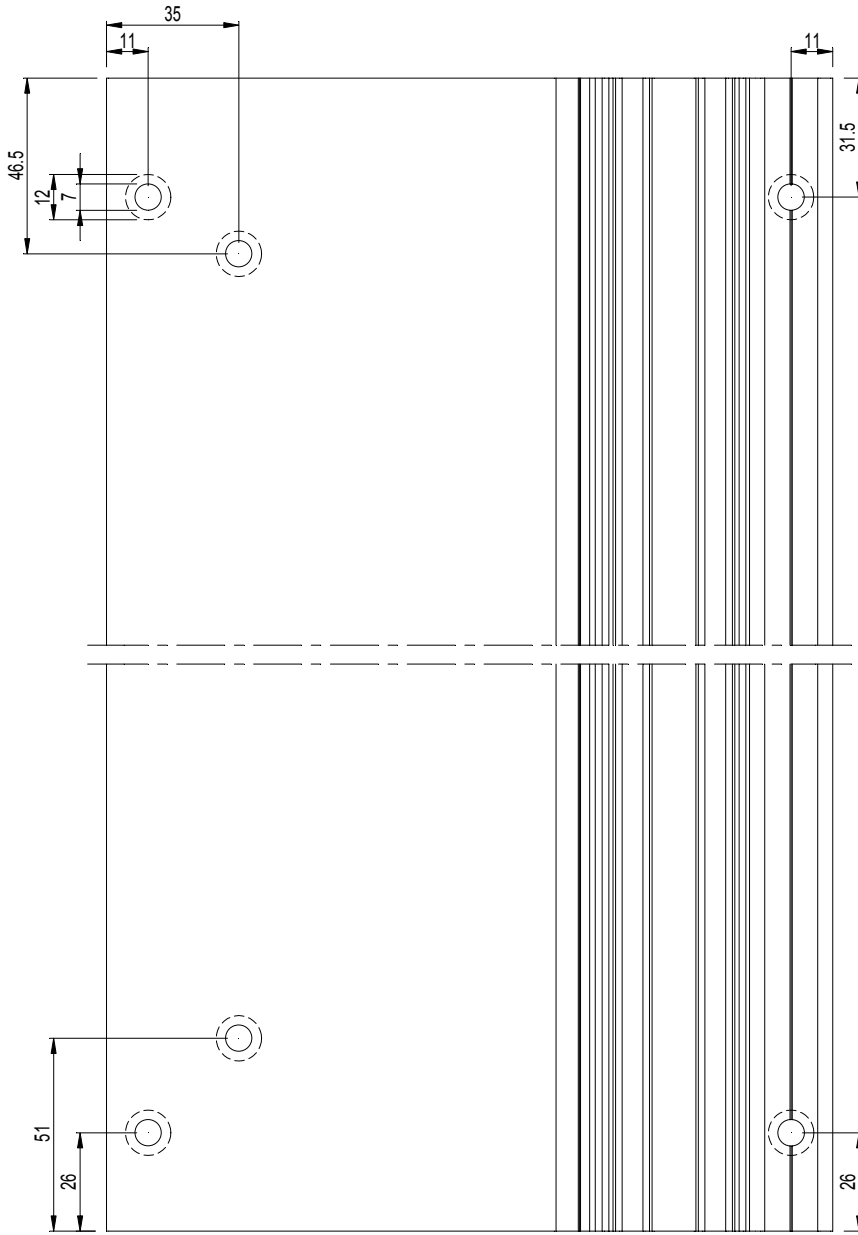

095.H800.00

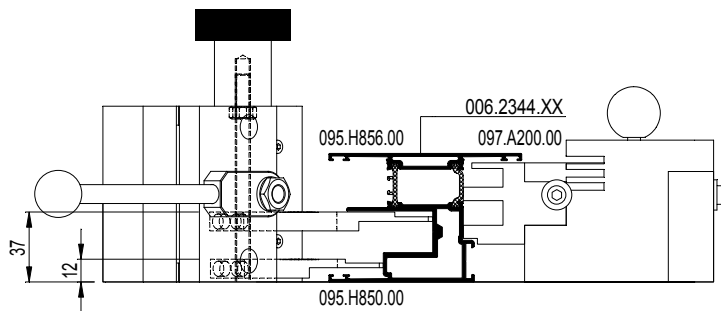
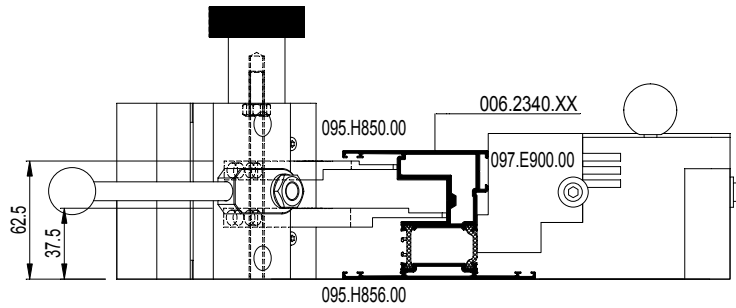

095.B500.00

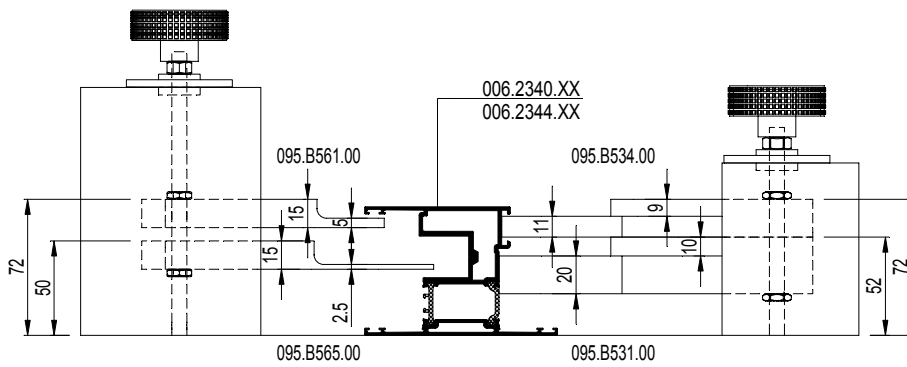

VOLGORDE

1. Correct zagen
2. Ontbramen (indien noodzakelijk)
3. Stof en zaagresten verwijderen
4. Ontvetten met Reynafinish 60, art. nr. 086.9210.--
5. Reynaprotector aanbrengen, art. nr. 086.9208.-- + 086.9225.--
6. Verlijmen: - in de profielkamer
- op de plaats waar de steunhoek komt door middel van reynaseal duo, art. nr. 084.9080.--
7. Verbinding tot stand brengen en persen
8. Zichtvlakken reinigen met Reynafinish 60 art.nr. 086.9210.--

Equerres à sertir

ORDRE

1. Tronçonnage correct
2. Ebavurage (si nécessaire)
3. Enlèvement de poussières et de copeaux de sciage
4. Dégraissage avec Reynafinish 60, art. nr. 086.9210.--
5. Application de Reynaprotector, art. nr. 086.9208.-- + 086.9225.--
6. Encollage: - dans la chambre du profilé
- dans la rainure destinée à la cale de feuillure au moyen de reynaseal duo, art. n° 084.9080.--
7. Assemblage et sertissage
8. Nettoyage des surfaces visibles au moyen de Reynafinish 60 art.nr. 086.9210.--

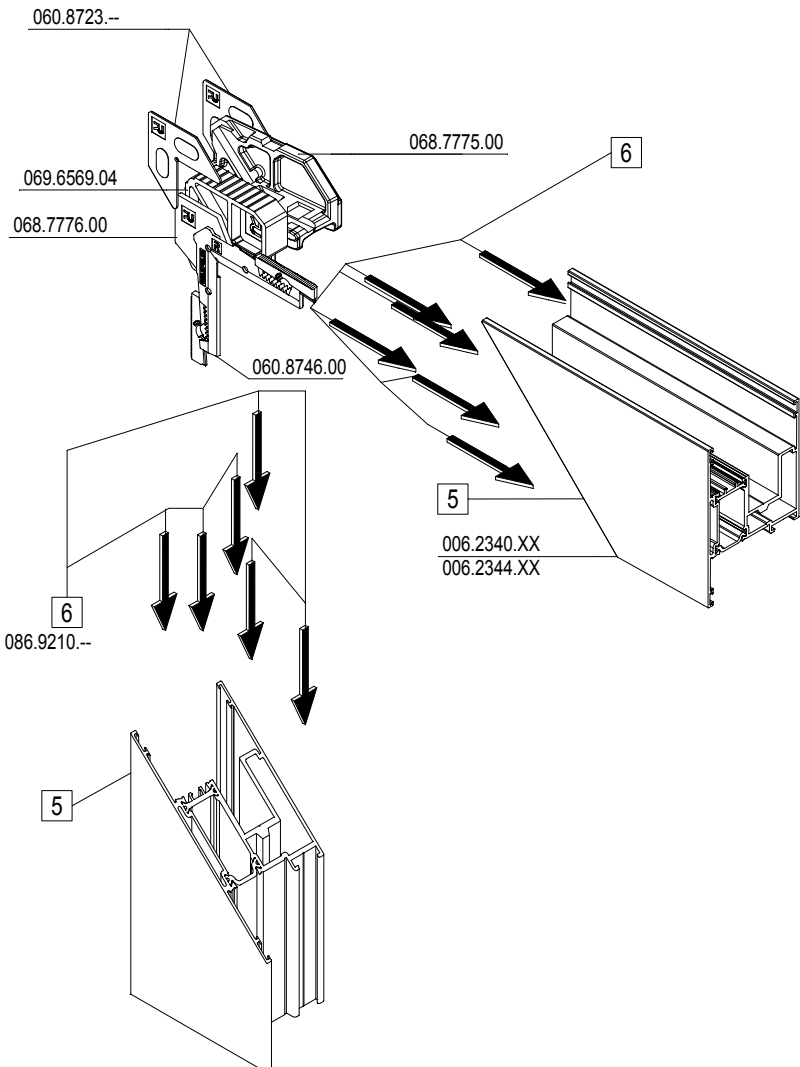

Crimp corner cleats

SEQUENCE

1. Correct sawing
2. Deburring (if necessary)
3. Removing dust and saw-dust
4. Degreasing with Reynafinish 60, art. nr. 086.9210.--
5. Applying Reynaprotector, art. nr. 086.9208.-- + 086.9225.--
6. Glueing: - in the profile chamber
- in the area where the rebate support will be inserted by means of reynaseal duo, art. no. 084.9080.--
7. Assembly and crimping
8. Cleaning visible surfaces by means of Reynafinish 60 art.nr. 086.9210.--

Presseckwinkel

REIHENFOLGE

1. Zuschneiden
2. Entgraten (falls erforderlich)
3. Staub und Sägereste entfernen
4. Entfetten mit Reynafinish 60, art. nr. 086.9210.--
5. Reynaprotector aufbringen, Art. Nr. 086.9208.-- +086.9225.--
6. Klebereinsatz: - in die Eckwinkelkammer
- im Bereich des Glasanschlagwinkels mit reynaseal duo, Art. nr. 084.9080.--
7. Verbinden und verpressen
8. Die Sichtseiten säubern mit Reynafinish 60 art.nr. 086.9210.--

MONTAGEVOLGORDE
L'ORDRE DE MONTAGE
THE ORDER OF ASSEMBLY
MONTAGEREIHENFOLGE

1 2 3 .

CP 155 CP 155-LS

SCHROEFHOEKVERBINDING VLEUGEL
 ASSEMBLAGE EQUERRE OUVRANT
 SCREW CORNER CONNECTION VENT
 SCHRAUBECKWINKELVERBINDUNG FLUEGEL

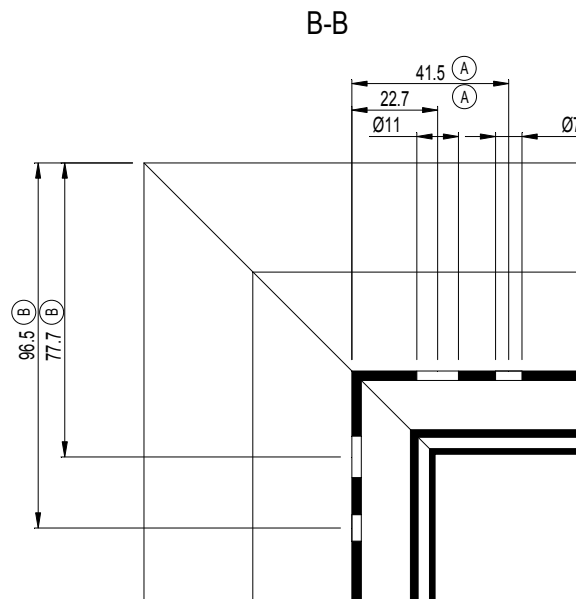
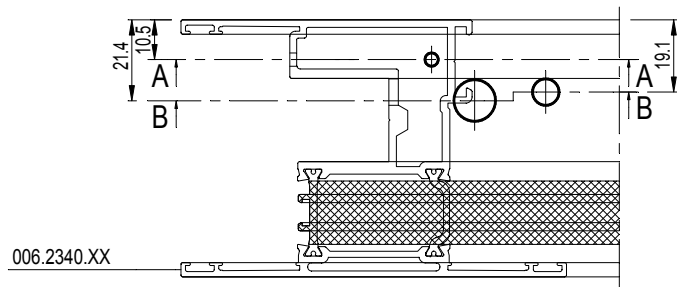
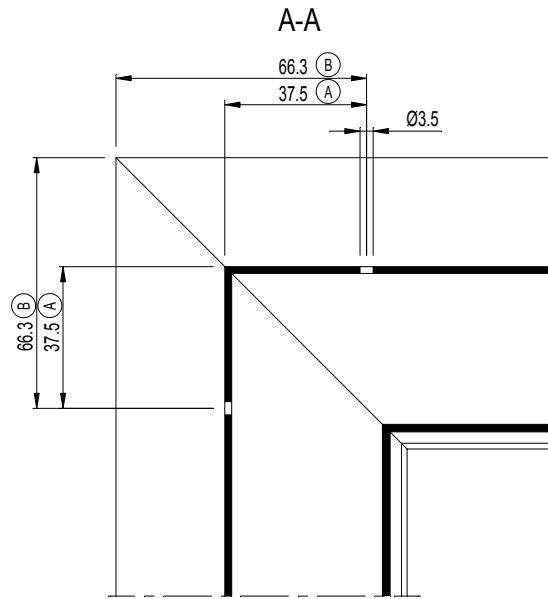
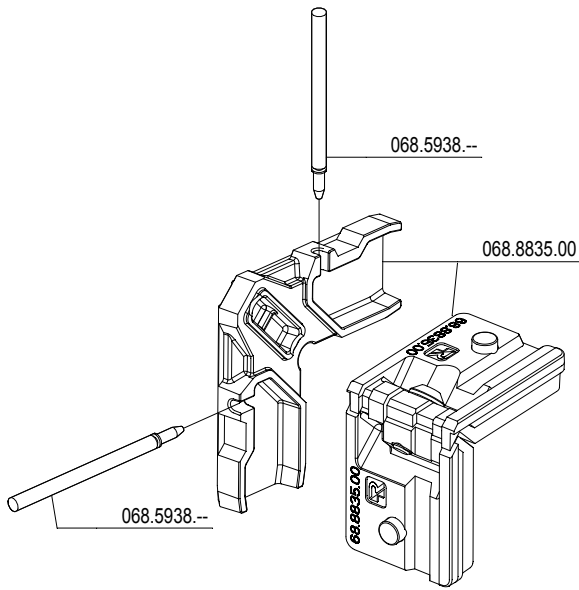

(A)		097.0441.00
(B)		SBZ 122 SBZ 140

CP 155-AP CP 155-LS/AP

SCHROEFHOEKVERBINDING VLEUGEL
ASSEMBLAGE EQUERRE OUVRANT
SCREW CORNER CONNECTION VENT
SCHRAUBECKWINKELVERBINDUNG FLUEGEL

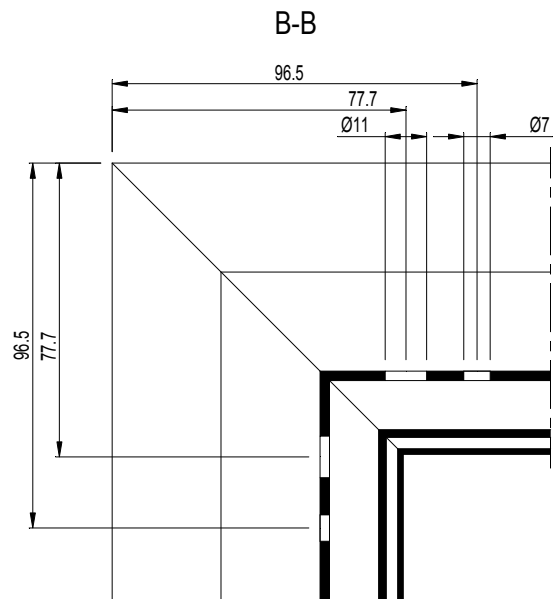
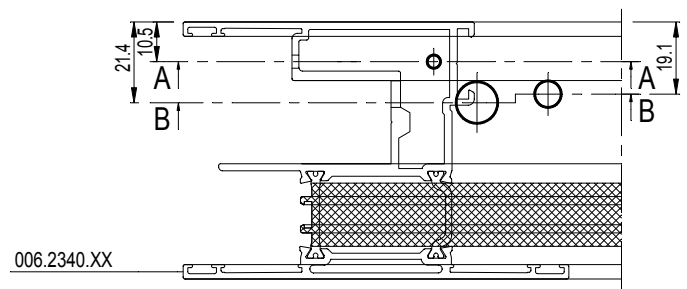
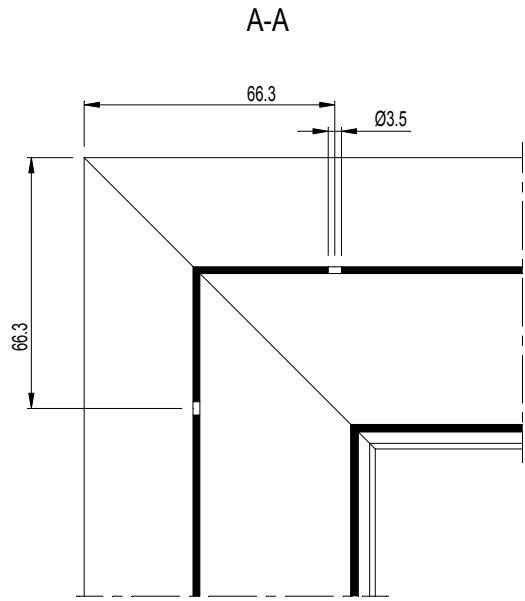
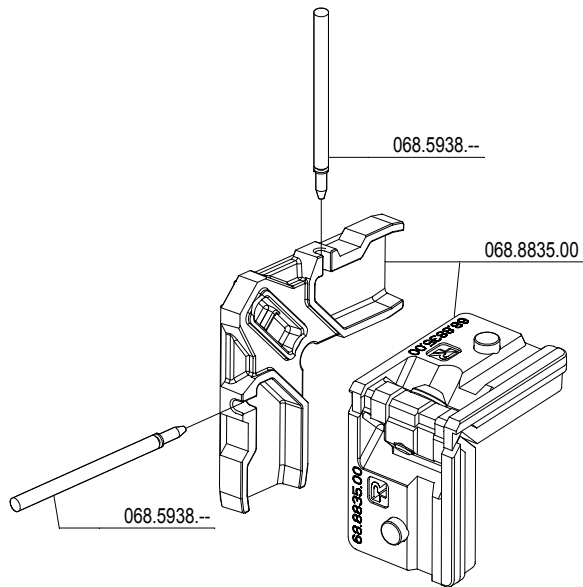

	SBZ 122
	SBZ 140

CP 155
CP 155-LS

T-VERBINDINGEN
RACCORDEMENTS-T
T-CONNECTIONS
T-VERBINDUNGEN



T-verbindingen

VOLGORDE

1. Correct zagen
2. Ontbramen (indien noodzakelijk)
3. Stof en zaagresten verwijderen
4. Ontvetten met Reynafinish 60, art. nr. 086.9210.--
5. Reynaprotector aanbrengen, art. nr. 086.9208.-- + 086.9225.--
6. Verbinding tot stand brengen
7. Zichtvlakken reinigen met Reynafinish 60 art.nr. 086.9210.--

Assemblages T

ORDRE

1. Tronçonnage, poinçonnage ou forage correct
2. Ebavurage (si nécessaire)
3. Enlèvement de poussières et de copeaux de sciage
4. Dégraissage avec Reynafinish 60, art. nr. 086.9210.--
5. Application de Reynaprotector, art. nr. 086.9208.-- + 086.9225.--
6. Assemblage
7. Nettoyage des surfaces visibles au moyen de Reynafinish 60 art.nr. 086.9210.--

T-brackets

SEQUENCE

1. 1. Correct sawing, punching or drilling
2. Deburring (if necessary)
3. Removing dust and saw-dust
4. Degreasing with Reynafinish 60, art. nr. 086.9210.--
5. Applying Reynaprotector, art. nr 086.9208.-- + 086.9225.--
6. Making the connection
7. Cleaning visible surfaces by means of Reynafinish 60 art.nr. 086.9210.--

T-Verbinder

REIHENFOLGE

1. Zuschneiden, stanzen oder bohren
2. Entgraten (falls erforderlich)
3. Staub und Sägereste entfernen
4. Entfetten mit Reynafinish 60, art. nr. 086.9210.--
5. Reynaprotector aufbringen, Art. Nr. 086.9209.-- + 086.9225.--
6. Verbinden
7. Die Sichtseiten säubern mit Reynafinish 60 art.nr. 086.9210.--

CP 155 CP 155-LS

T-VERBINDER MET SCHROEF EN/OF NAGEL
JONCTION-T AVEC VIS ET/OU CHEVILLE
T-BRACKET WITH SCREW AND/OR DRIVE PIN
T-VERBINDER MIT SCHRAUBE UND/ODER STIFT



	095.C700.00		095.C600.00	008.3120.XX 008.3123.XX
			097.X000.00	008.3114.XX
			097.X100.00	008.3824.XX
			097.X300.00	0K8.3824.XX
	095.C500.00		097.0410.00	
			095.C600.00	008.3113.XX
			097.O900.00	
			097.P000.00	
			097.X300.00	
			097.0410.00	
			097.0010.00	068.5920.--

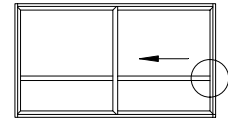

	Max. draaggewicht 170kg Poids de portée maximale 170kg Maximal bearing weight 170kg Maximales Traggewicht 170kg	068.8730.00 068.8731.00 068.8732.00 068.8733.00
	Max. draaggewicht 250kg Poids de portée maximale 250kg Maximal bearing weight 250kg Maximales Traggewicht 250kg	068.8734.00

MONTAGEVOLGORDE
L'ORDRE DE MONTAGE
THE ORDER OF ASSEMBLY
MONTAGEREIHENFOLGE

1 2 3 .

(R) REYNAPROTECTOR
REYNAPROTECTOR
REYNAPROTECTOR
REYNAPROTECTOR

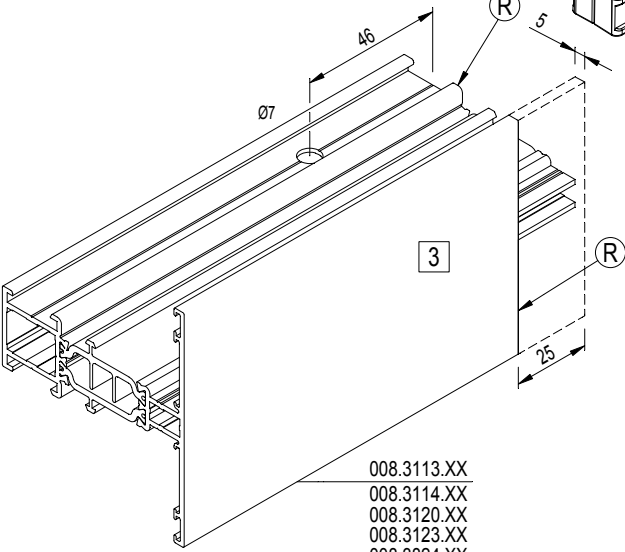
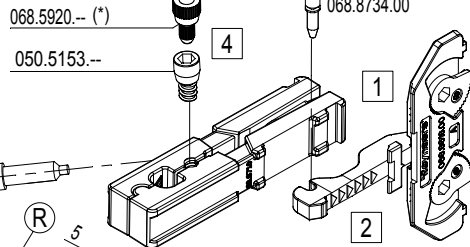

006.2340.XX
006.2344.XX

008.3113.XX
008.3114.XX
008.3120.XX
008.3123.XX
008.3824.XX
0K8.3824.XX

006.2344.XX
006.2340.XX

068.8730.00
068.8731.00
068.8732.00
068.8733.00
068.8734.00

008.3113.XX
008.3114.XX
008.3120.XX
008.3123.XX
008.3824.XX
0K8.3824.XX

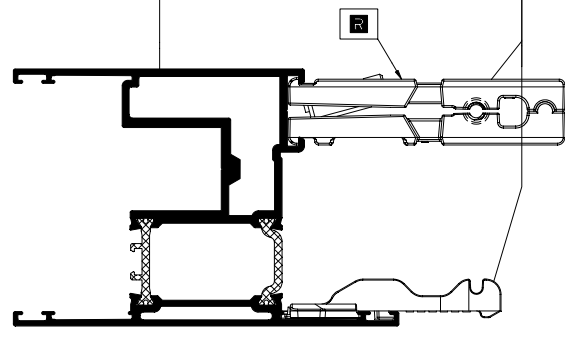
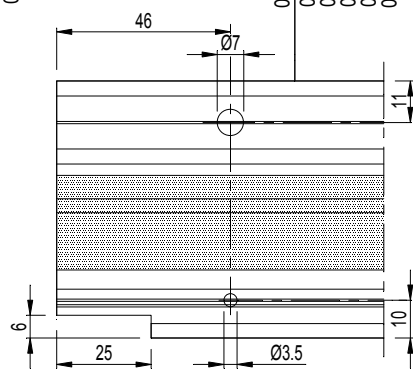

CP 155 CP 155-LS

T-VERBINDER MET SCHROEF EN/OF NAGEL
JONCTION-T AVEC VIS ET/OU CHEVILLE
T-BRACKET WITH SCREW AND/OR DRIVE PIN
T-VERBINDER MIT SCHRAUBE UND/ODER STIFT



	095.C700.00		095.C600.00	008.3120.XX
			097.X000.00	008.3123.XX
			097.X100.00	008.3114.XX
	095.C500.00		097.X300.00	008.3824.XX
			097.X300.00	0K8.3824.XX
			097.0410.00	
			097.0010.00	068.5920.--

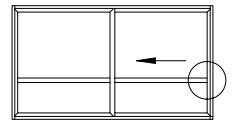

	Max. draaggewicht 170kg Poids de portée maximale 170kg Maximal bearing weight 170kg Maximales Traggewicht 170kg	068.8730.00 068.8731.00 068.8732.00 068.8733.00
	Max. draaggewicht 250 kg Poids de portée maximale 250 kg Maximal bearing weight 250 kg Maximales Traggewicht 250 kg	068.8734.00

MONTAGEVOLGORDE
L'ORDRE DE MONTAGE
THE ORDER OF ASSEMBLY
MONTAGEREIHENFOLGE

1 2 3 .

REYNAPROTECTOR
REYNAPROTECTOR
REYNAPROTECTOR
REYNAPROTECTOR

068.5920.-- (*)

050.5153.--

5

068.8740.00
068.8741.00
068.8742.00
068.8743.00

1

2

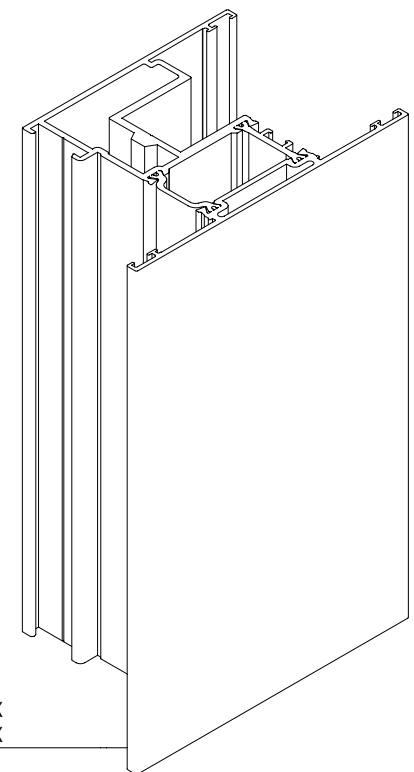
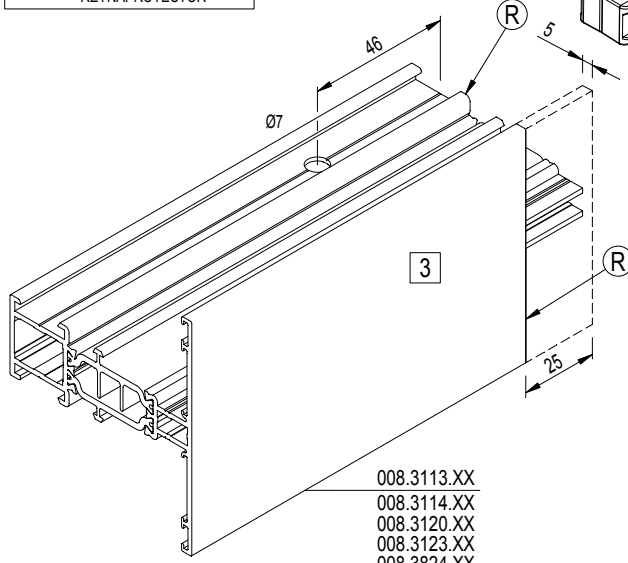

006.2340.XX
006.2344.XX

008.3113.XX
008.3114.XX
008.3120.XX
008.3123.XX
008.3824.XX
0K8.3824.XX

006.2344.XX
006.2340.XX

068.8740.00
068.8741.00
068.8742.00
068.8743.00

008.3113.XX
008.3114.XX
008.3120.XX
008.3123.XX
008.3824.XX
0K8.3824.XX

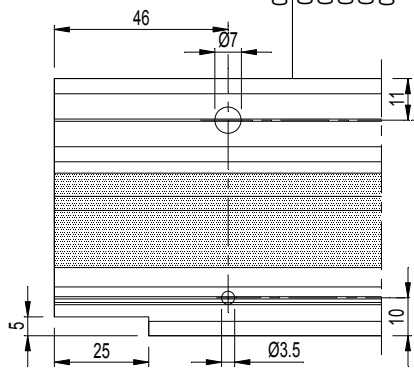
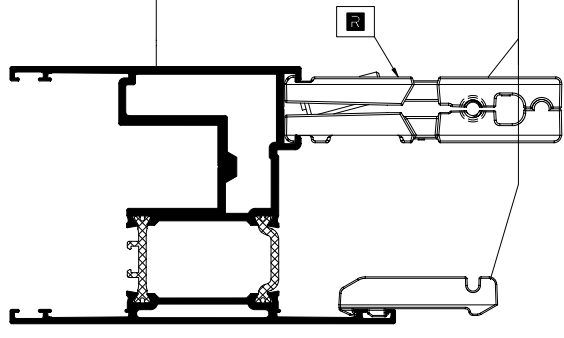

CP 155 CP 155-LS

T-VERBINDING MONORAIL
RACCORDEMENT-T MONORAIL
T-CONNECTION MONORAIL
T-VERBINDUNG MONORAIL

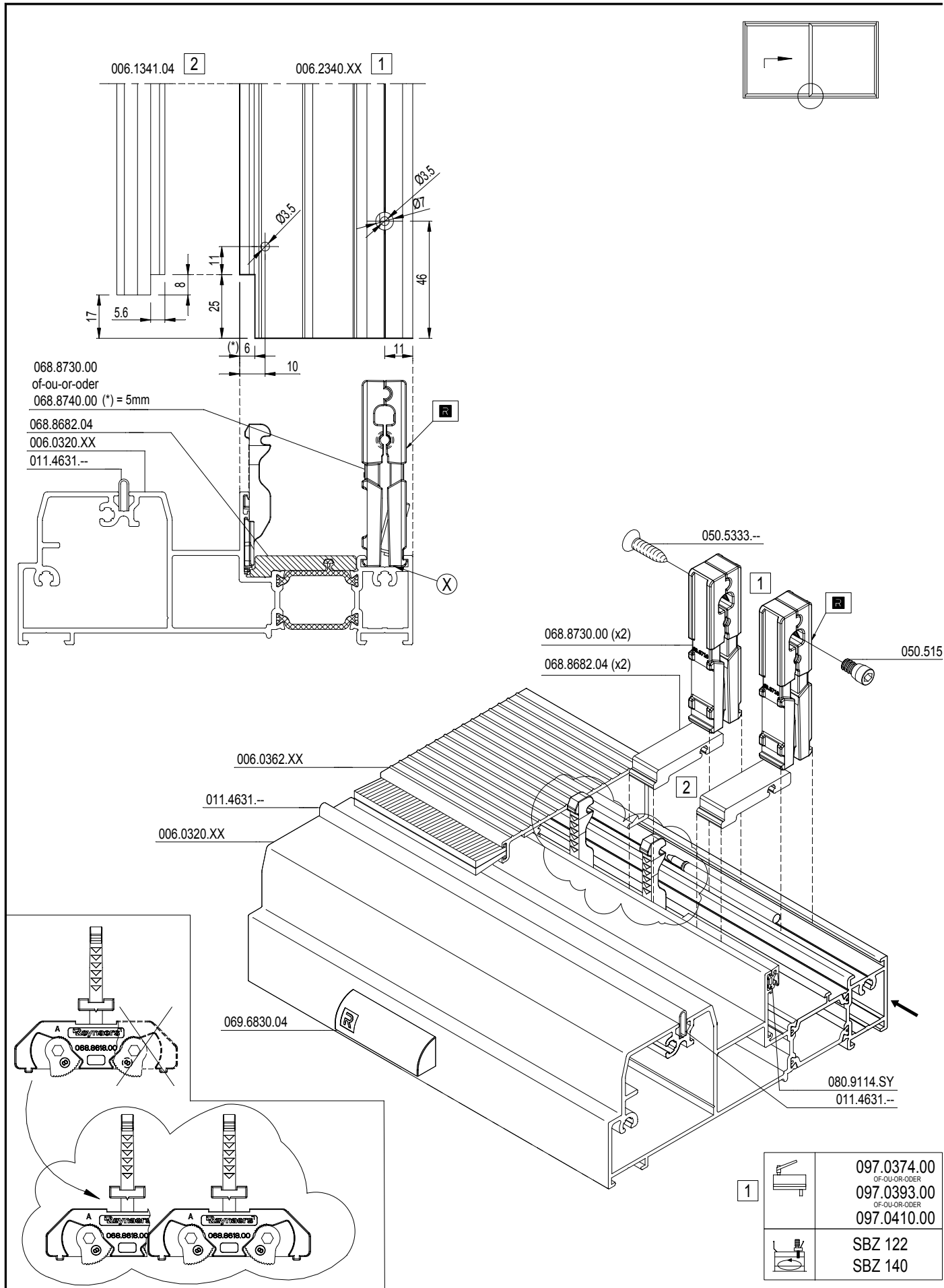

CP 155 CP 155-LS

T-VERBINDING MONORAIL
RACCORDEMENT-T MONORAIL
T-CONNECTION MONORAIL
T-VERBINDUNG MONORAIL

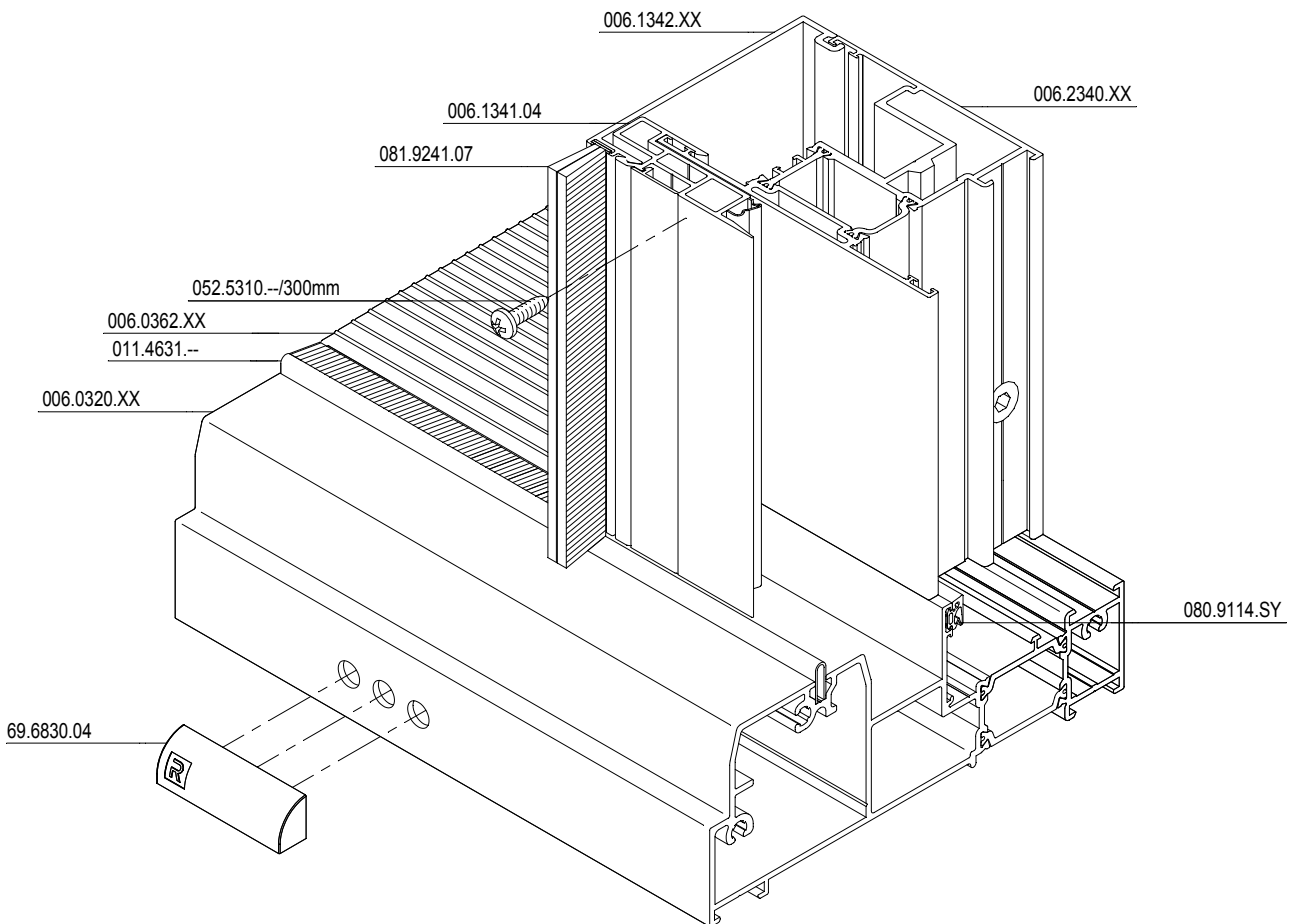
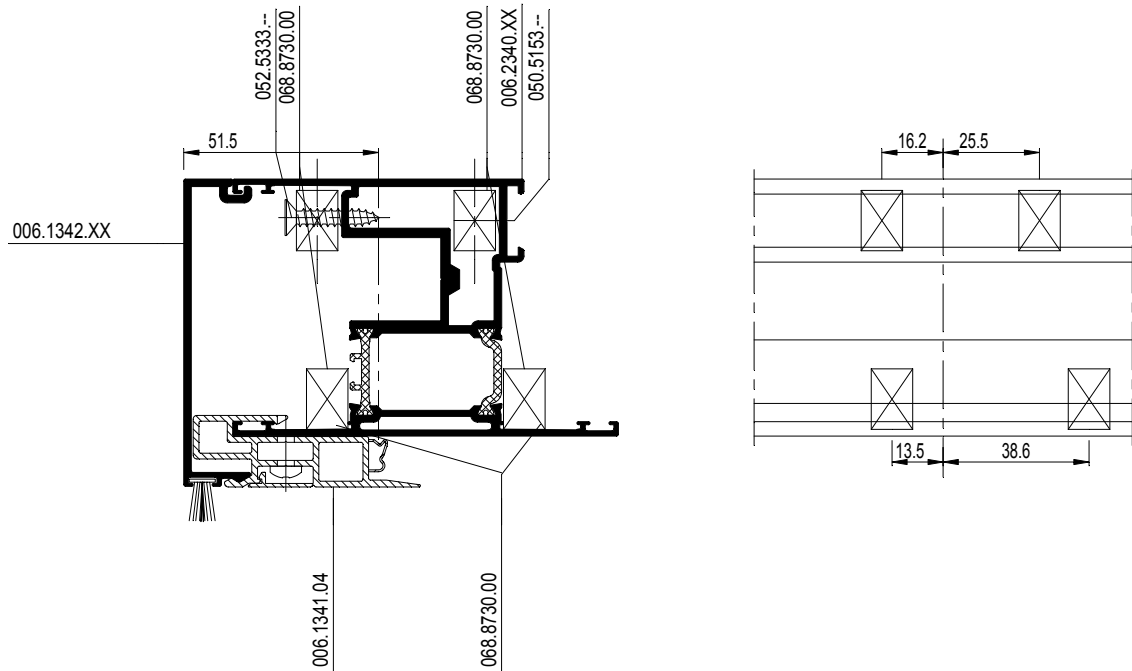

MONTAGEVOLGORDE
L'ORDRE DE MONTAGE
THE ORDER OF ASSEMBLY
MONTAGEREIHENFOLGE

1	2	3	.
---	---	---	---

(X) DICHTINGSMIDDEL
MATIERE D'ETANCHEITE
SEALING AGENT
ABDICHTUNG

CP 155 CP 155-LS

T-VERBINDING MONORAIL
RACCORDEMENT-T MONORAIL
T-CONNECTION MONORAIL
T-VERBINDUNG MONORAIL

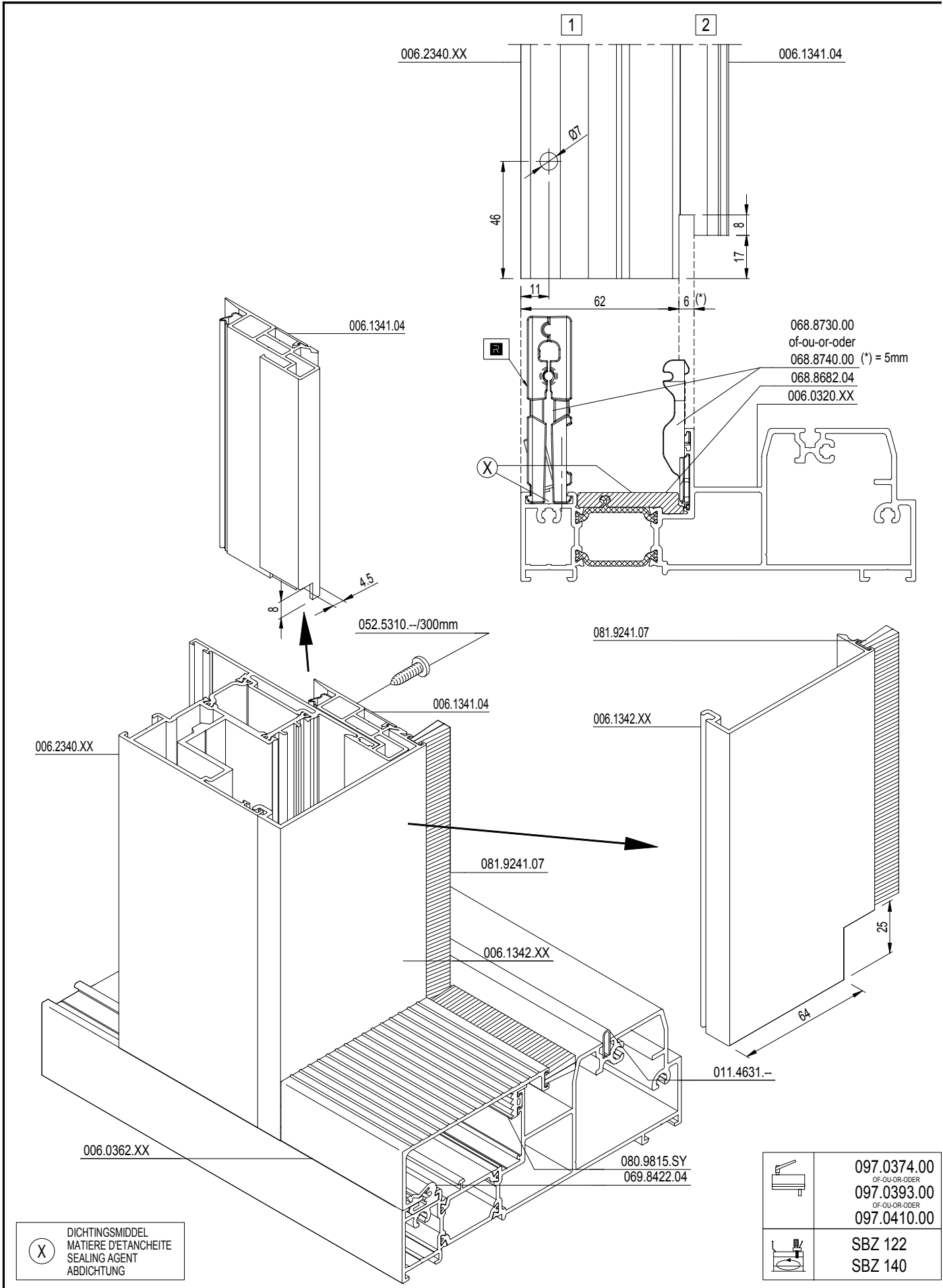

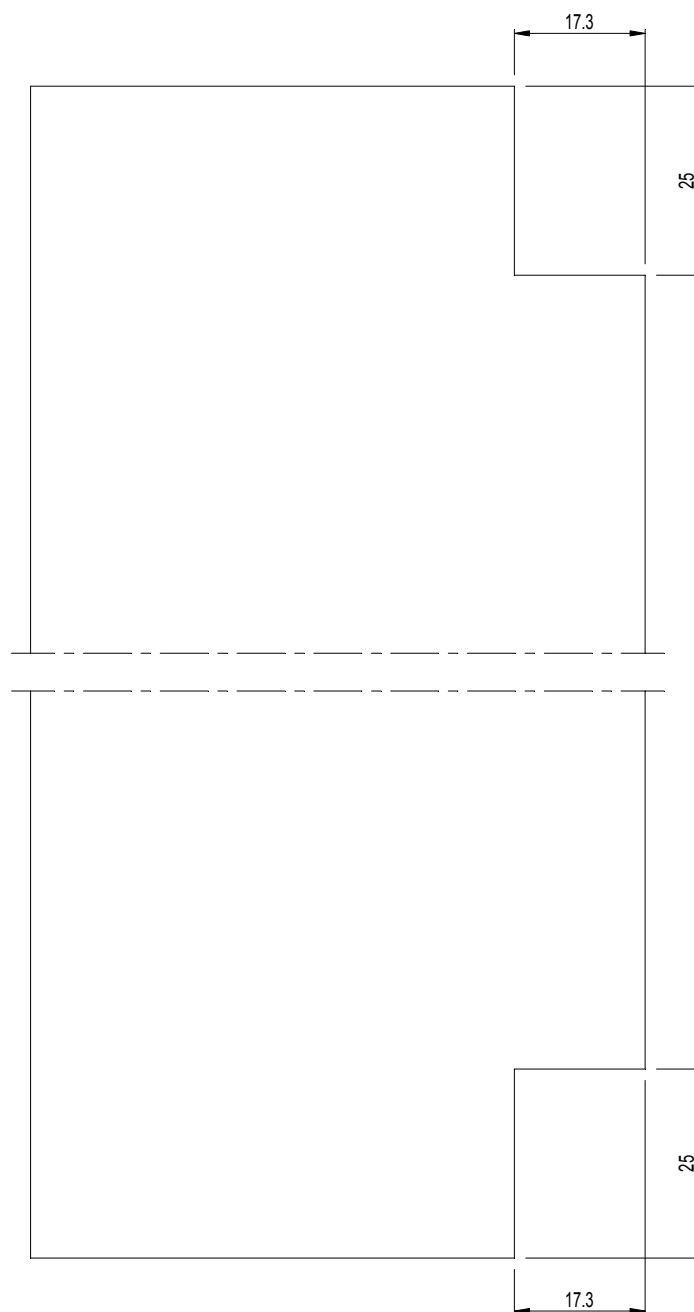
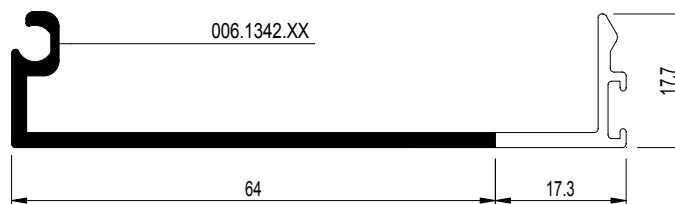

CP 155-LS/HI MINERGIE LABEL

T-VERBINDING MONORAIL
RACCORDMENT-T MONORAIL
T-CONNECTION MONORAIL
T-VERBINDUNG MONORAIL

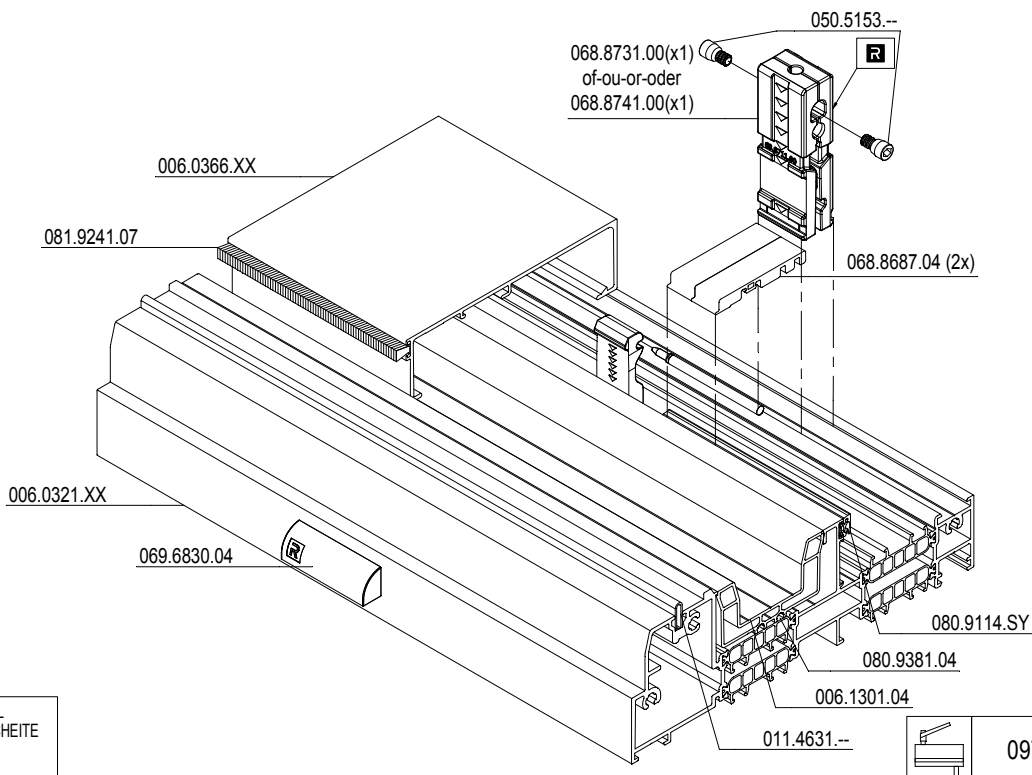
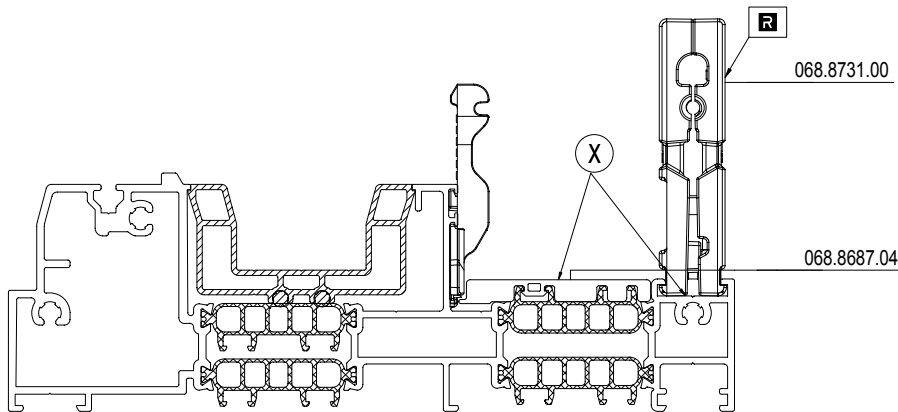
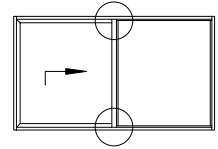
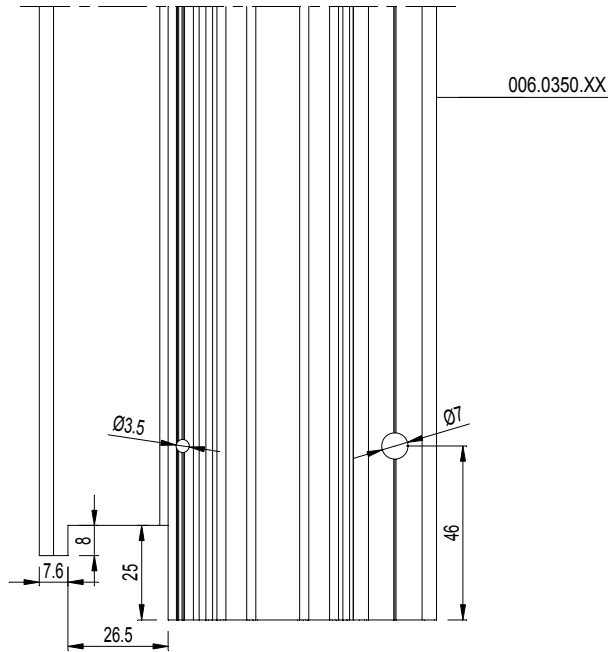

(X) DICHTINGSMIDDEL
MATIERE D'ETANCHEITE
SEALING AGENT
ABDICHTUNG



097.0664.00

D0084305

CP 155-LS/Hi MINERGIE LABEL

T-VERBINDING MONORAIL
RACCORDEMENT-T MONORAIL
T-CONNECTION MONORAIL
T-VERBINDUNG MONORAIL

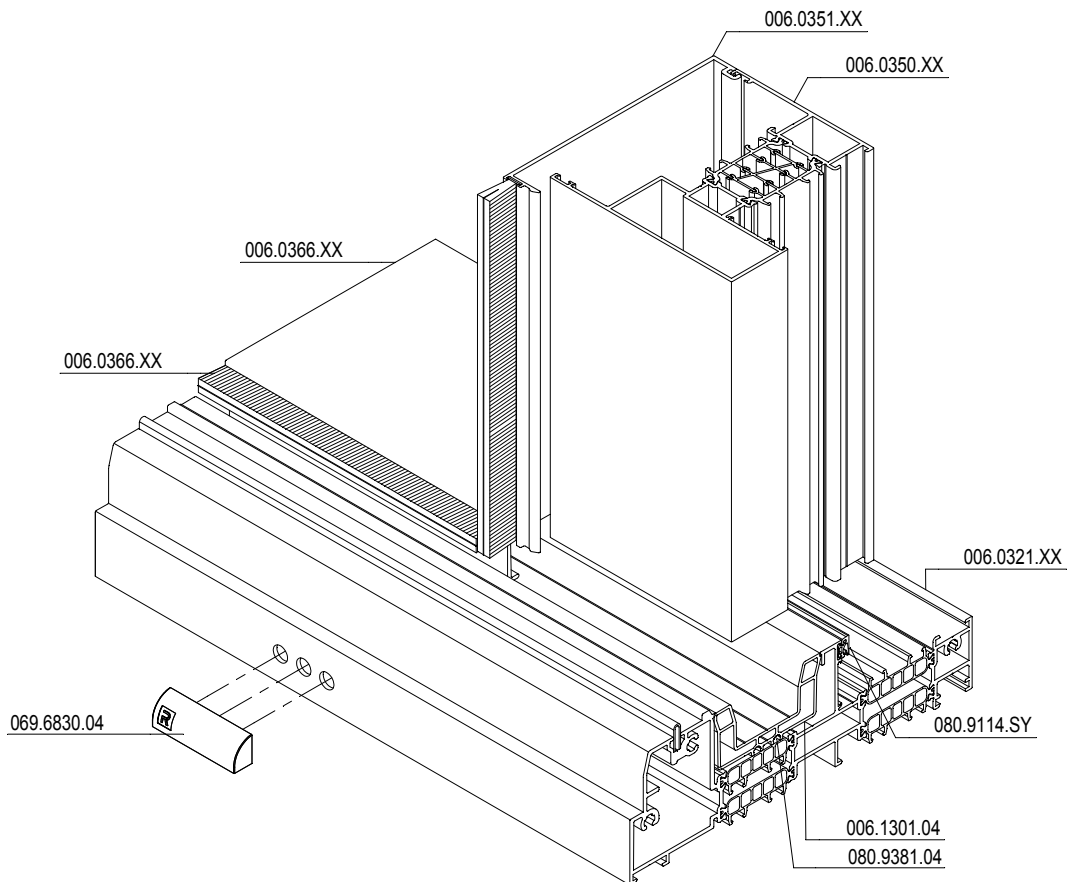
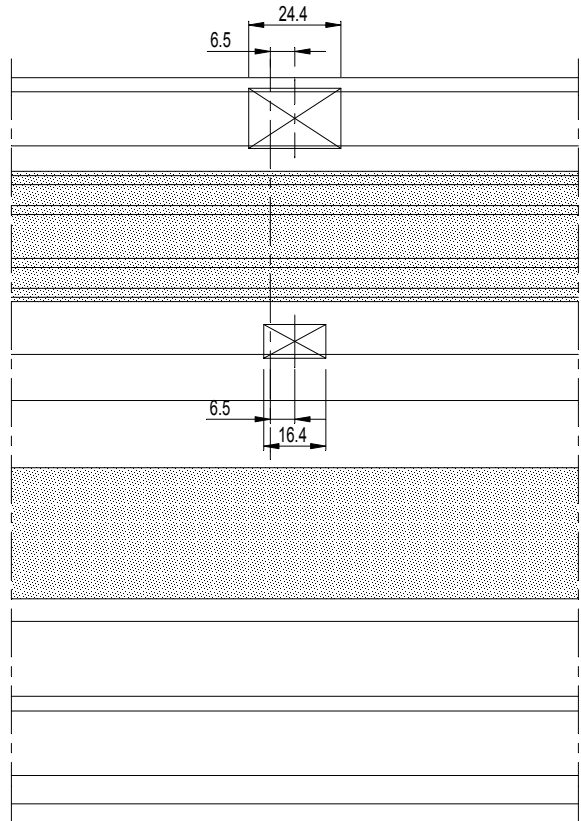
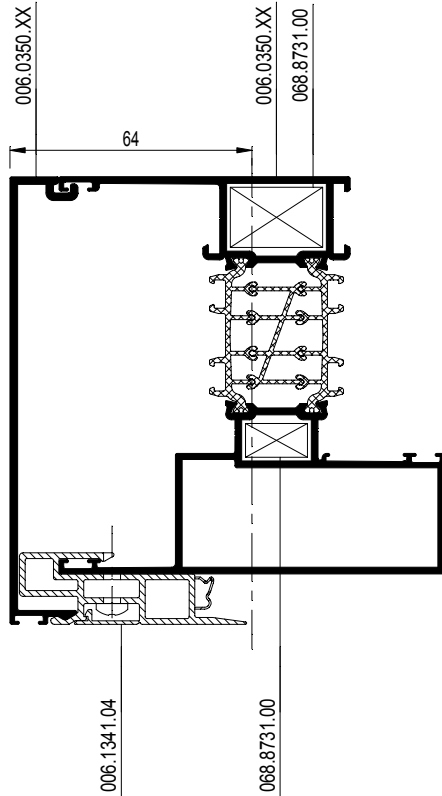

CP 155-LS/HI MINERGIE LABEL

T-VERBINDING MONORAIL
RACCORDMENT-T MONORAIL
T-CONNECTION MONORAIL
T-VERBINDUNG MONORAIL



CP 155-LS/HI MINERGIE LABEL

T-VERBINDING MONORAIL
RACCORDEMENT-T MONORAIL
T-CONNECTION MONORAIL
T-VERBINDUNG MONORAIL

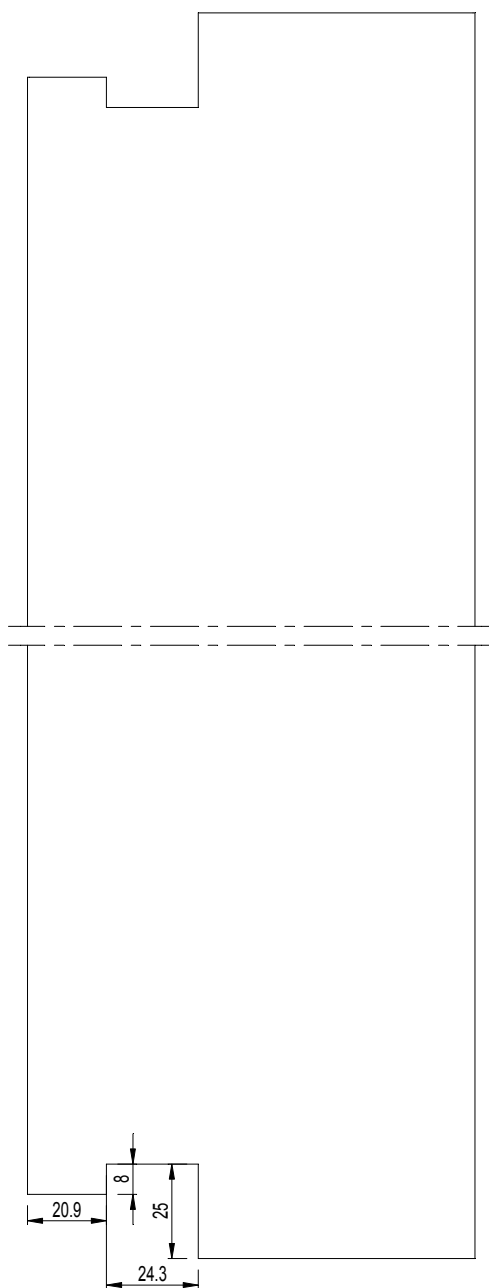

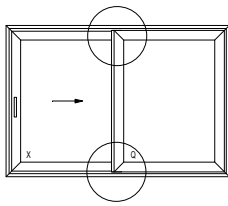

006.1300.XX

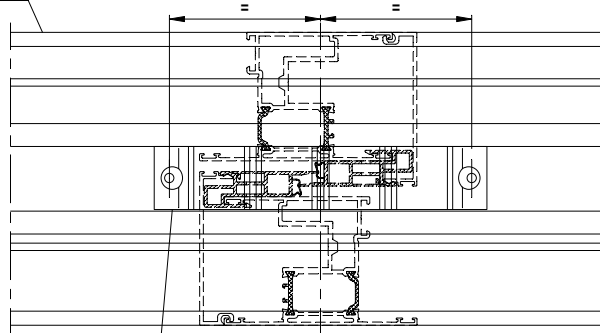

062.8025.04

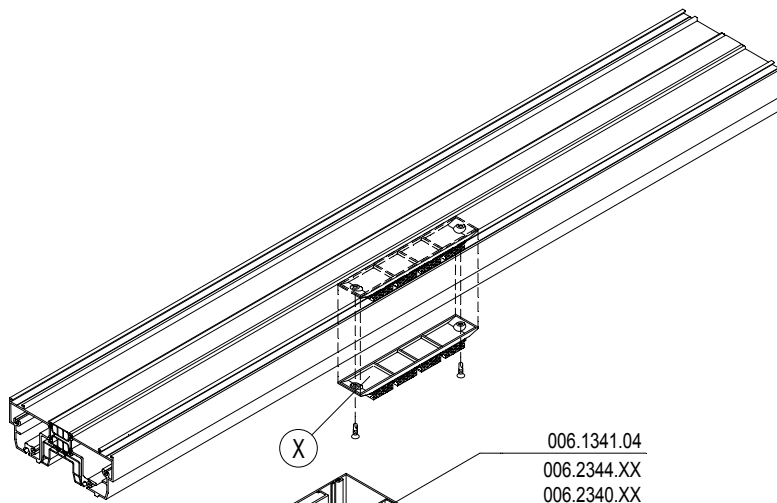

(X)

006.1341.04
 006.2344.XX
 006.2340.XX

006.1342.XX

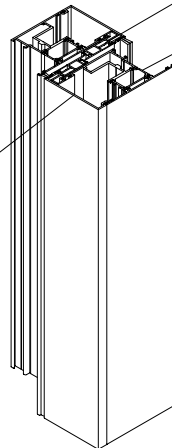

053.5403.--
 062.8025.04

(X)

006.1300.XX

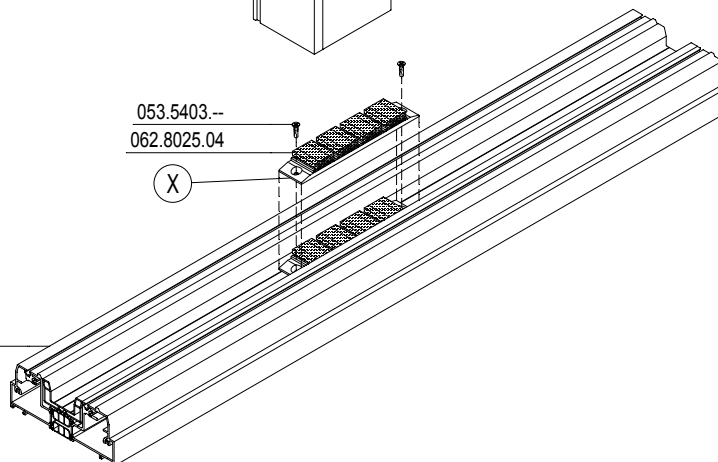

(X) DICHTINGSMIDDEL
 MATIERE D'ETANCHEITE
 SEALING AGENT
 ABDICHTUNG

D0075233

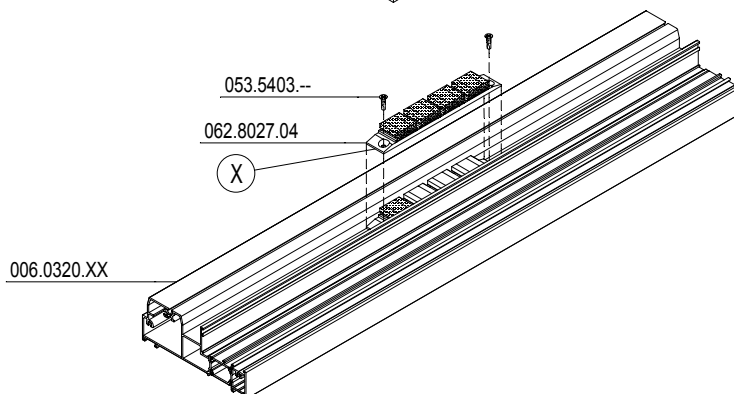
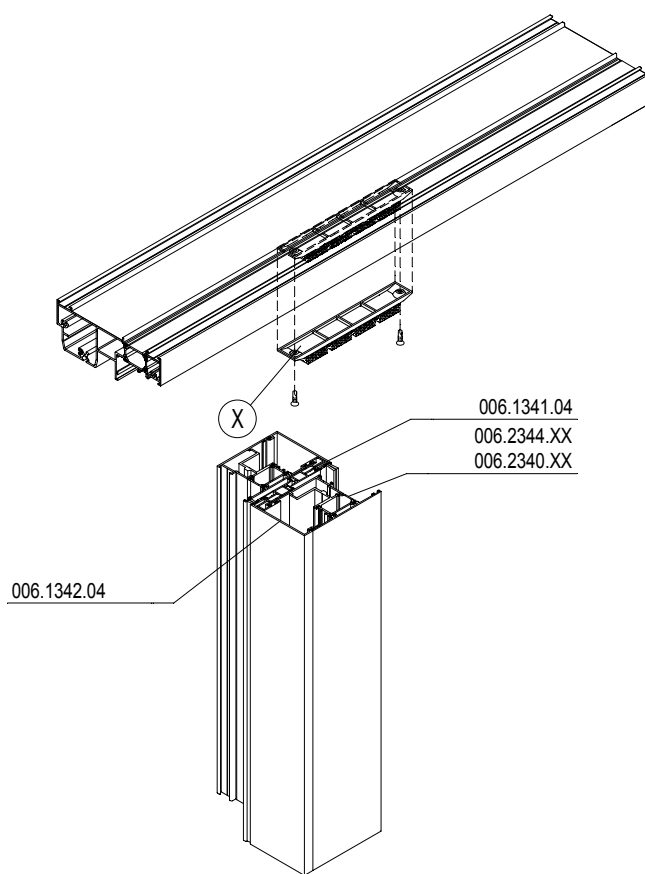
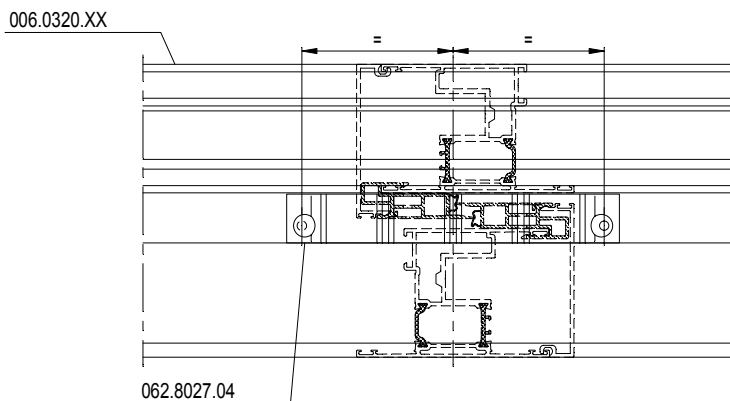
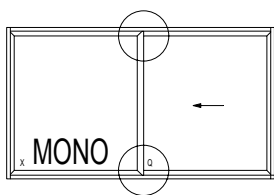

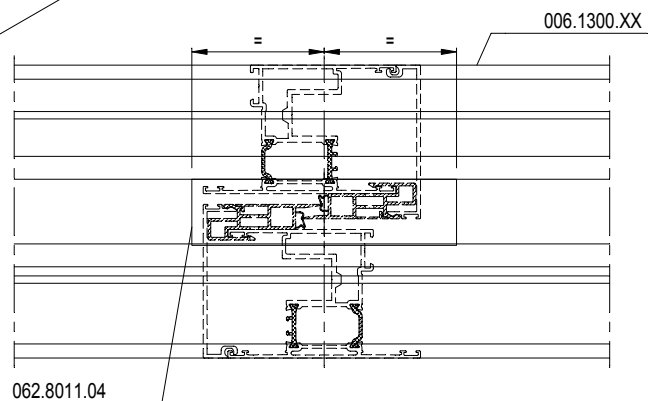
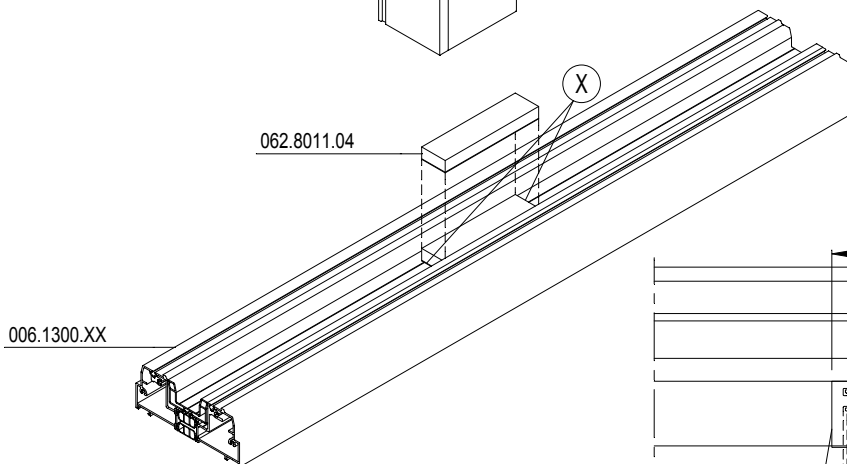
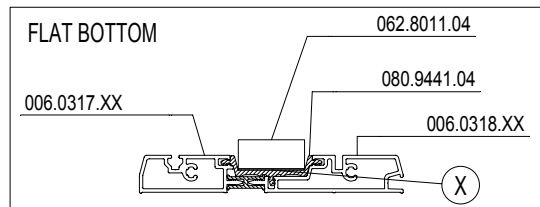
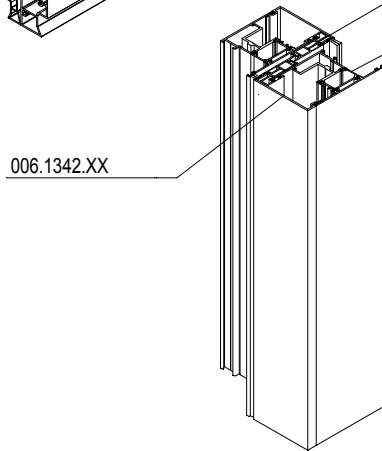
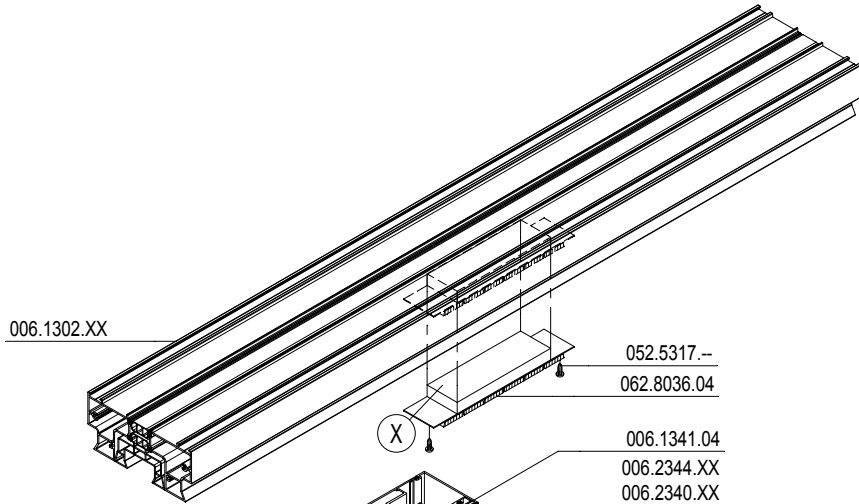
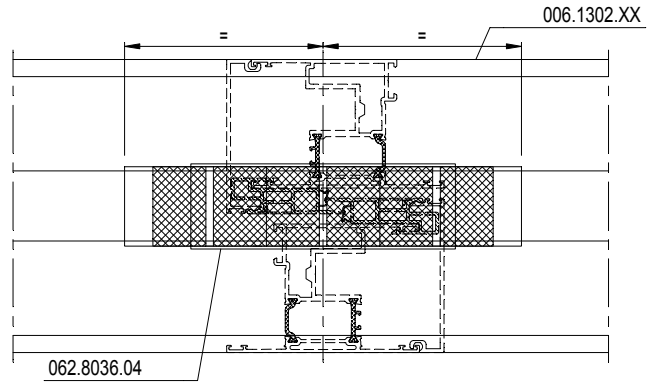
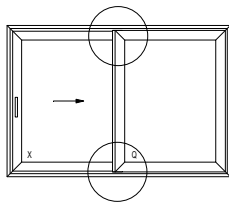

(X) DICHTINGSMIDDEL
 MATIERE D'ETANCHEITE
 SEALING AGENT
 ABDICHTUNG

CP 155-LS

MONTAGE AFDICHTING MET BORSTEL MONORAIL
MONTAGE FERMETURE AVEC BROSE MONORAIL
ASSEMBLY CLOSER WITH BRUSH MONORAIL
MONTAGE ABDICHTUNG MIT BUERSTE MONORAIL

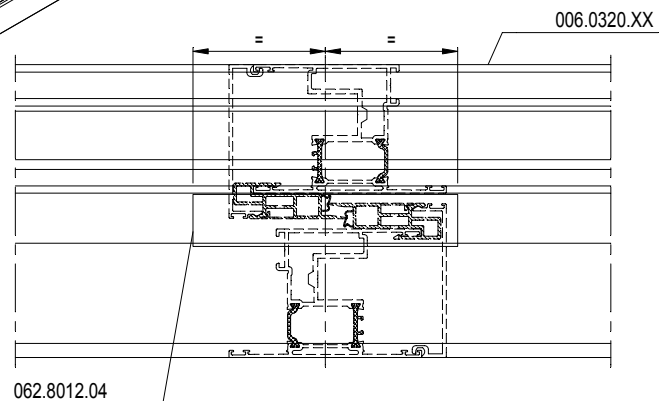
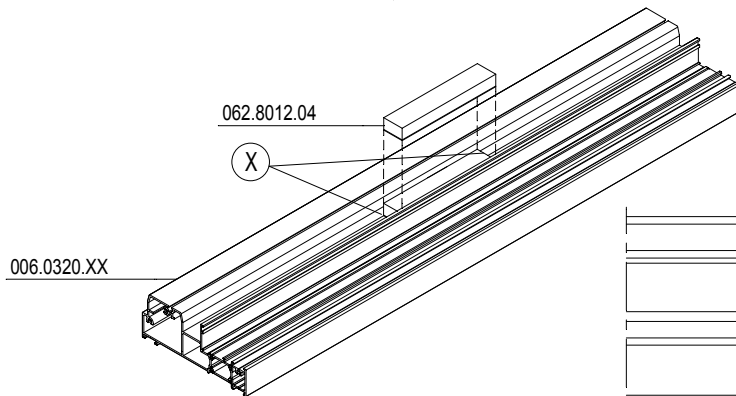
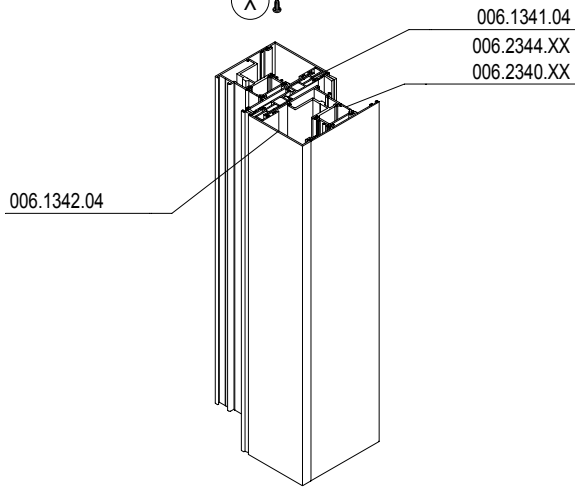
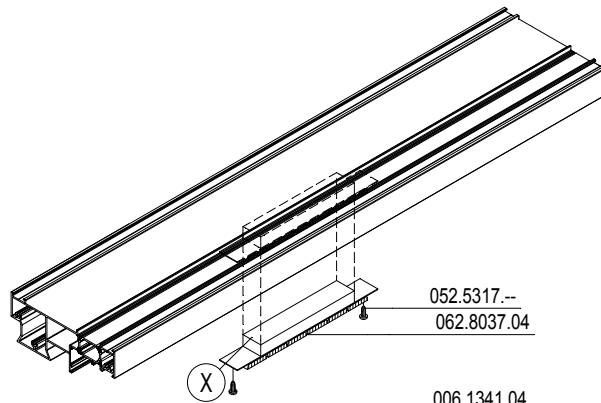
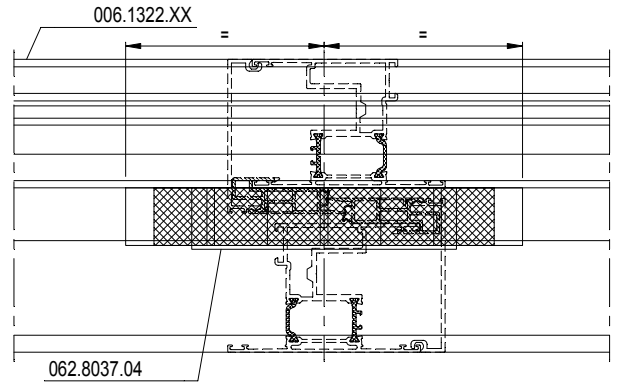
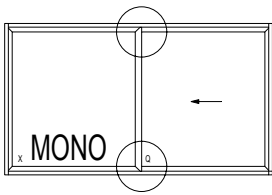

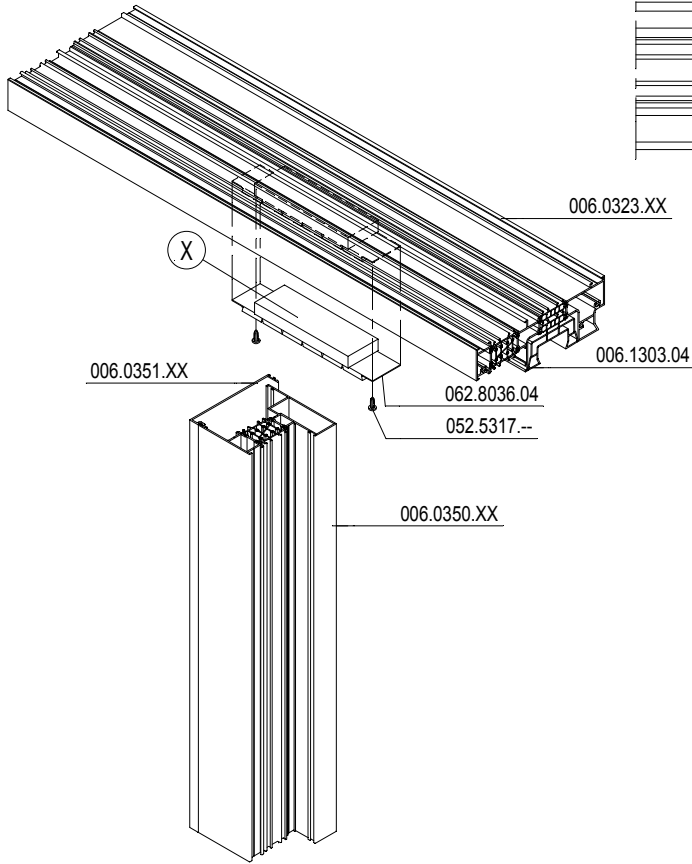
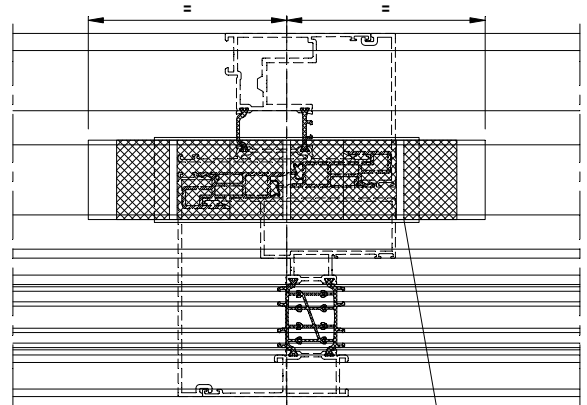
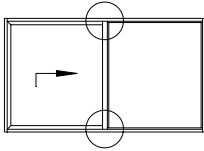

062.8036.04

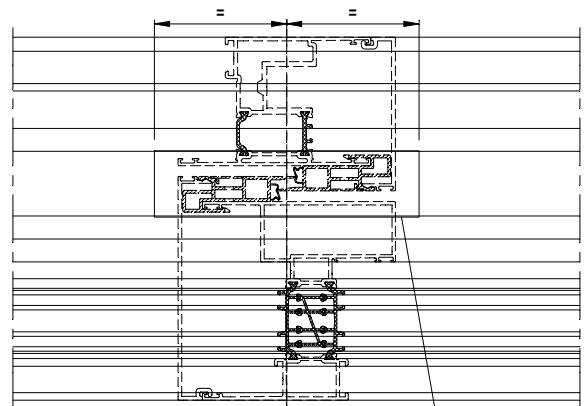
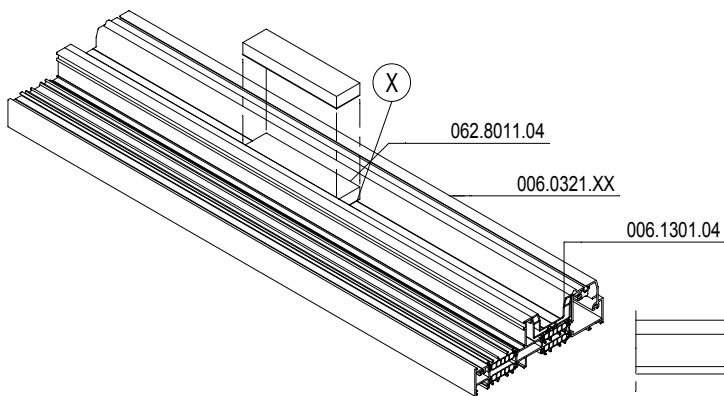

062.8011.04

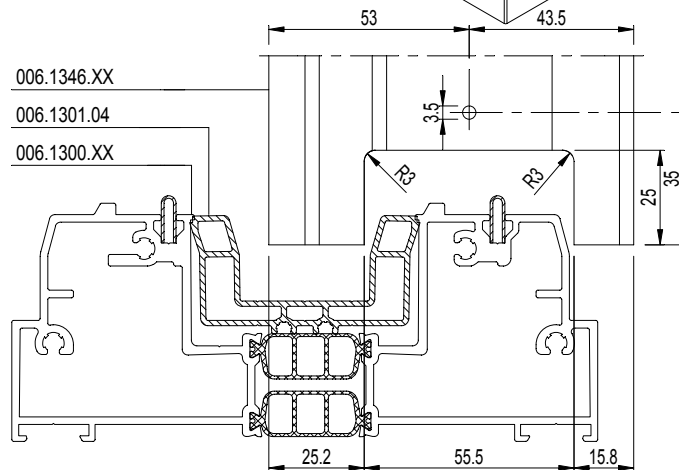
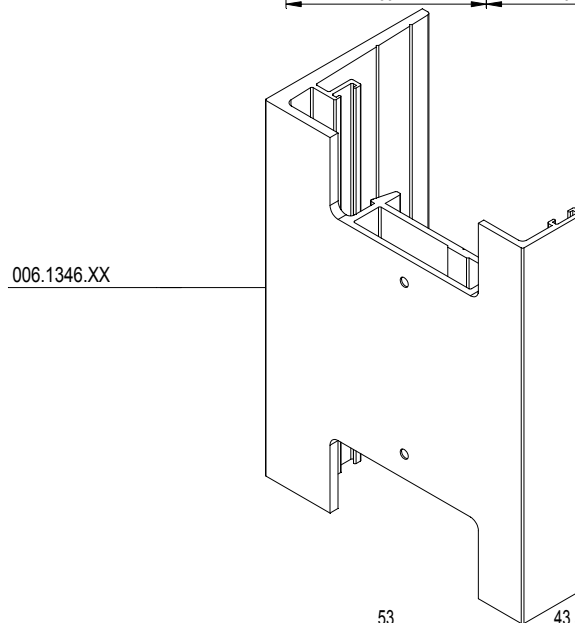
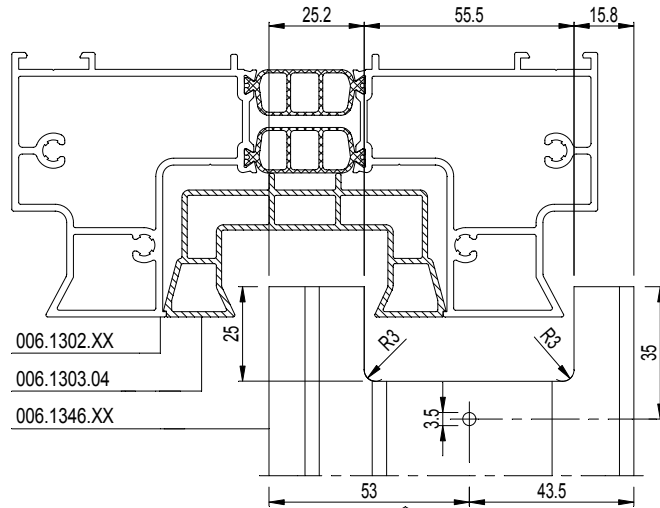
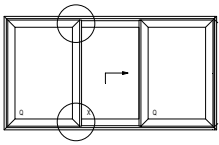

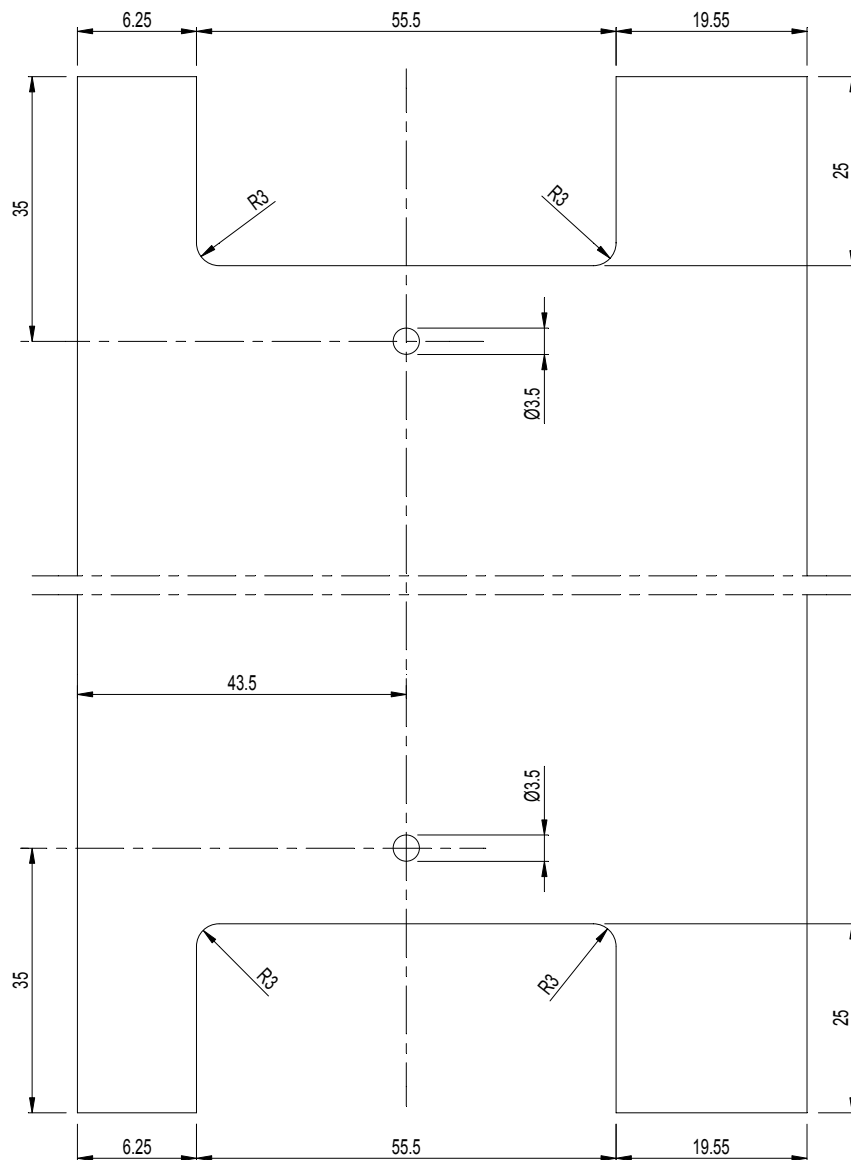
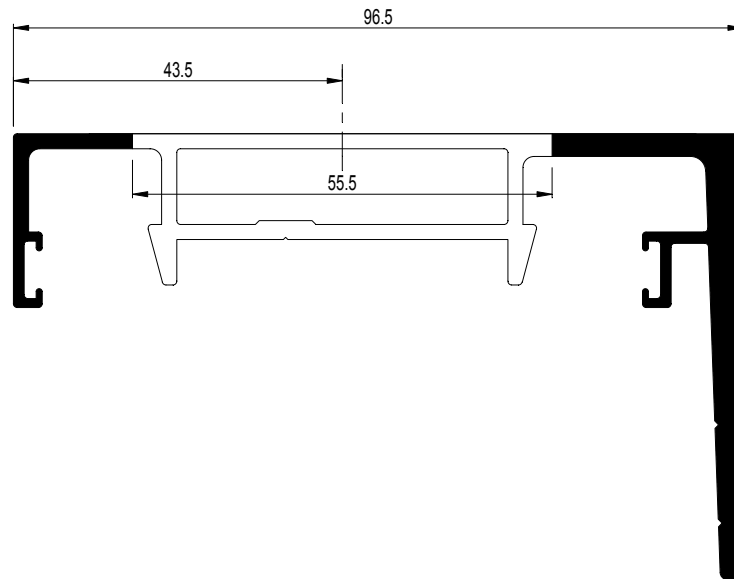

CP 155 CP 155-LS

MONTAGE SCHUIFVLEUGEL
MONTAGE VANTAIL COULISSANT
ASSEMBLY SLIDING VENT
MONTAGE SCHIEBEFLUEGEL

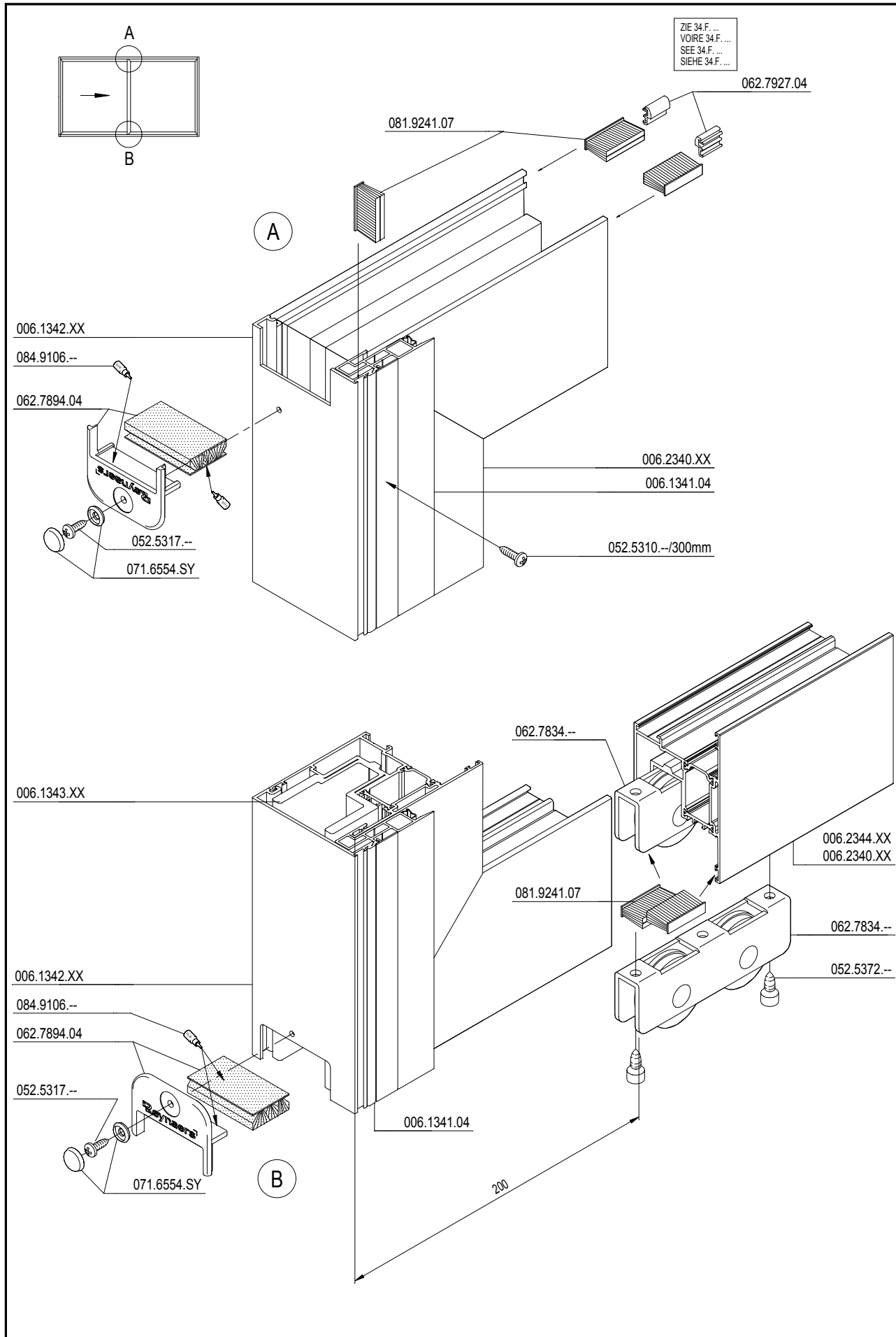

CP 155 CP 155-LS

MONTAGE SCHUIFVLEUGEL
MONTAGE VANTAIL COULISSANT
ASSEMBLY SLIDING VENT
MONTAGE SCHIEBEFLUEGEL



	095.C500.00		095.C600.00	
			097.U300.00	1
			097.U400.00	2
	095.C700.00		097.U300.00	1
			097.U400.00	2

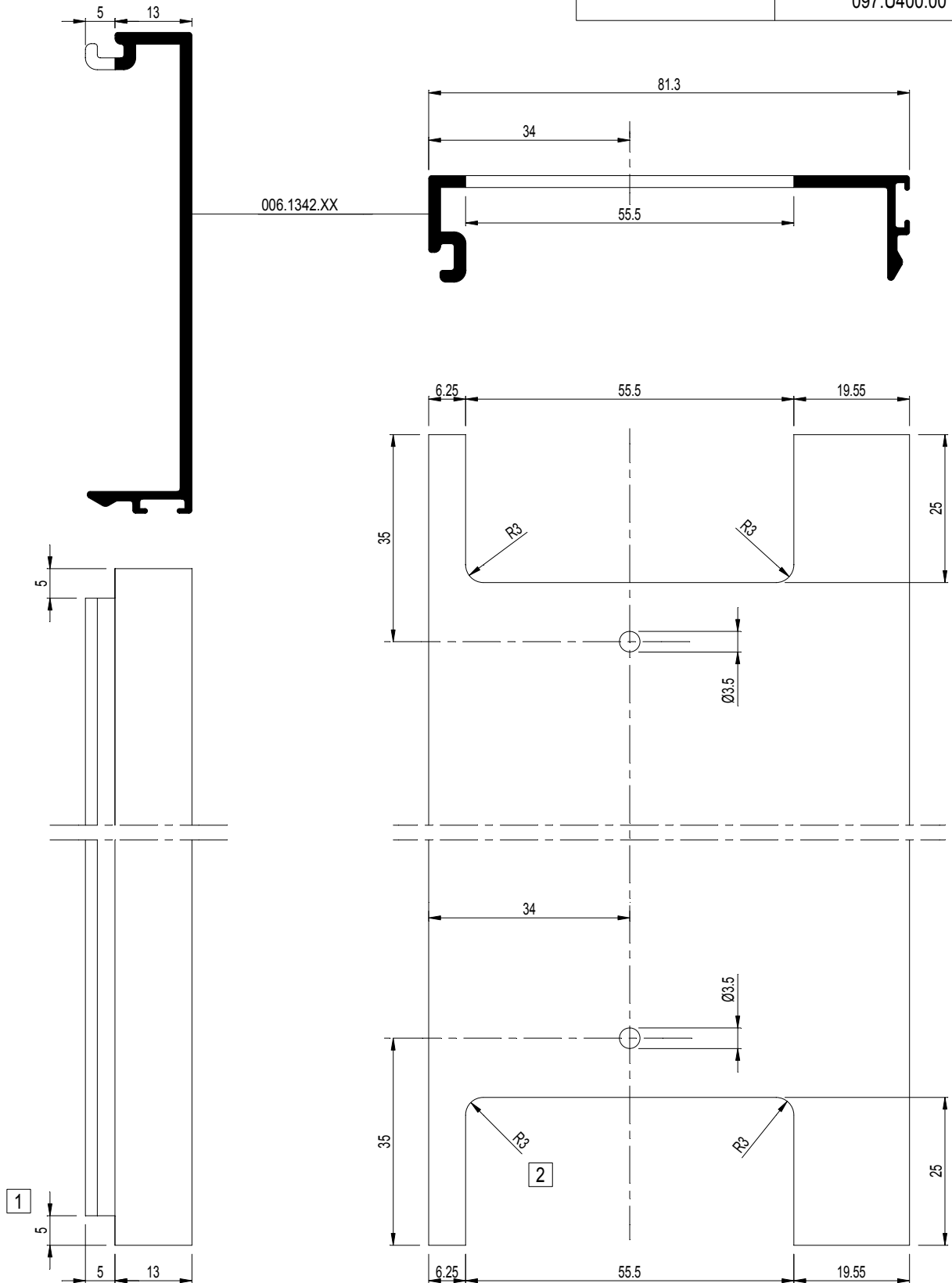

2-RAIL QXXQ

2-RAIL OXXO

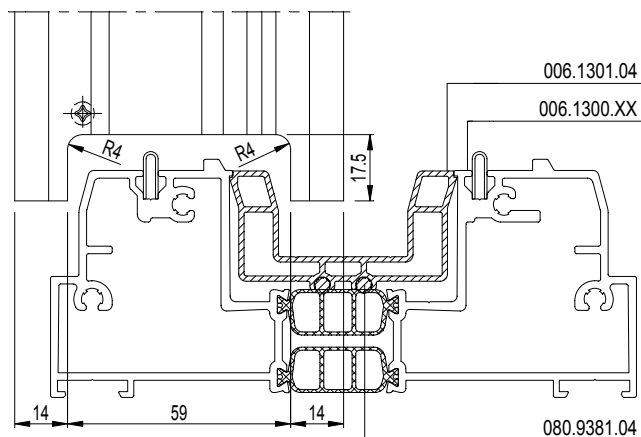
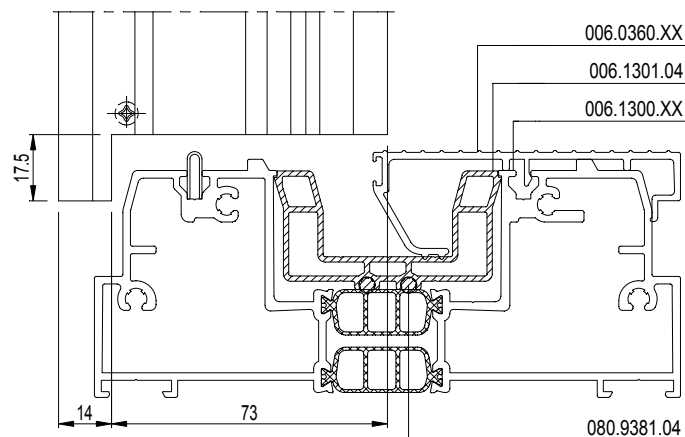
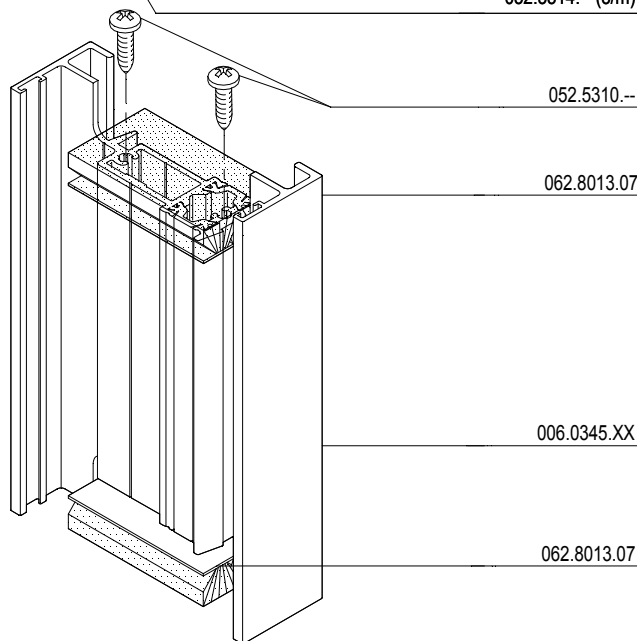
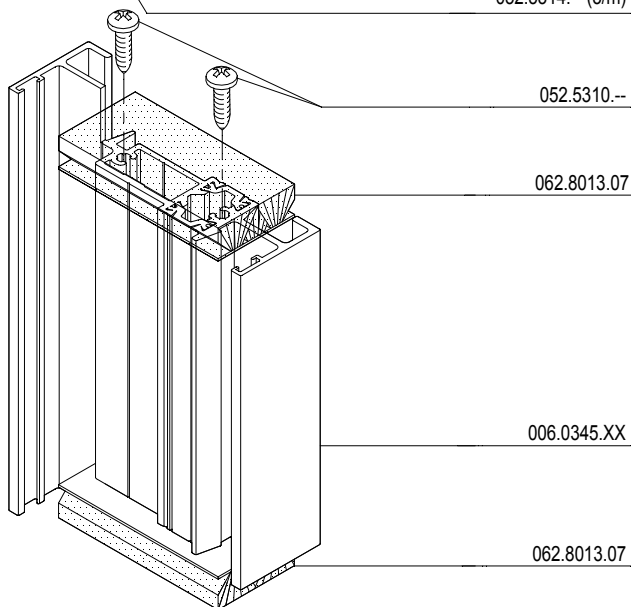
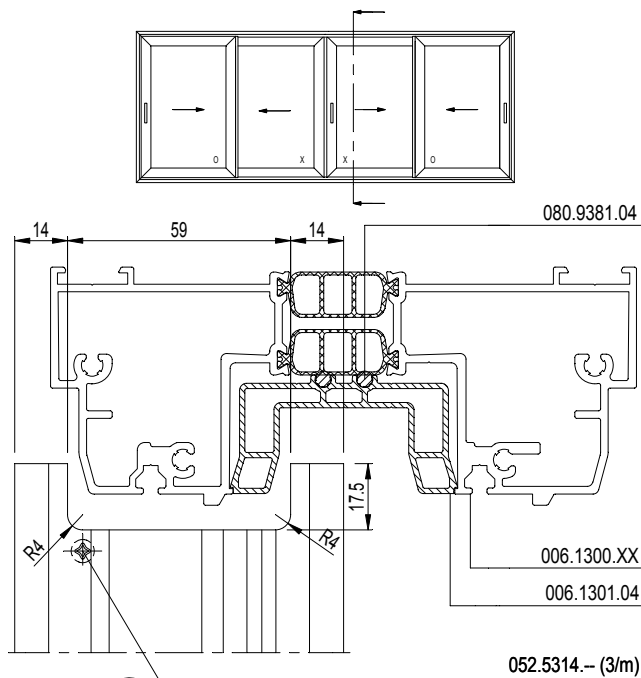
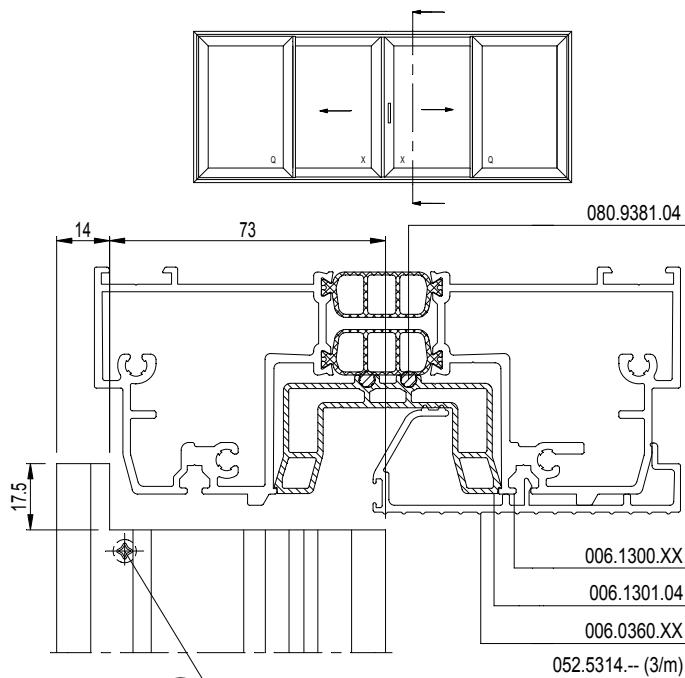

MONORAIL QXXQ

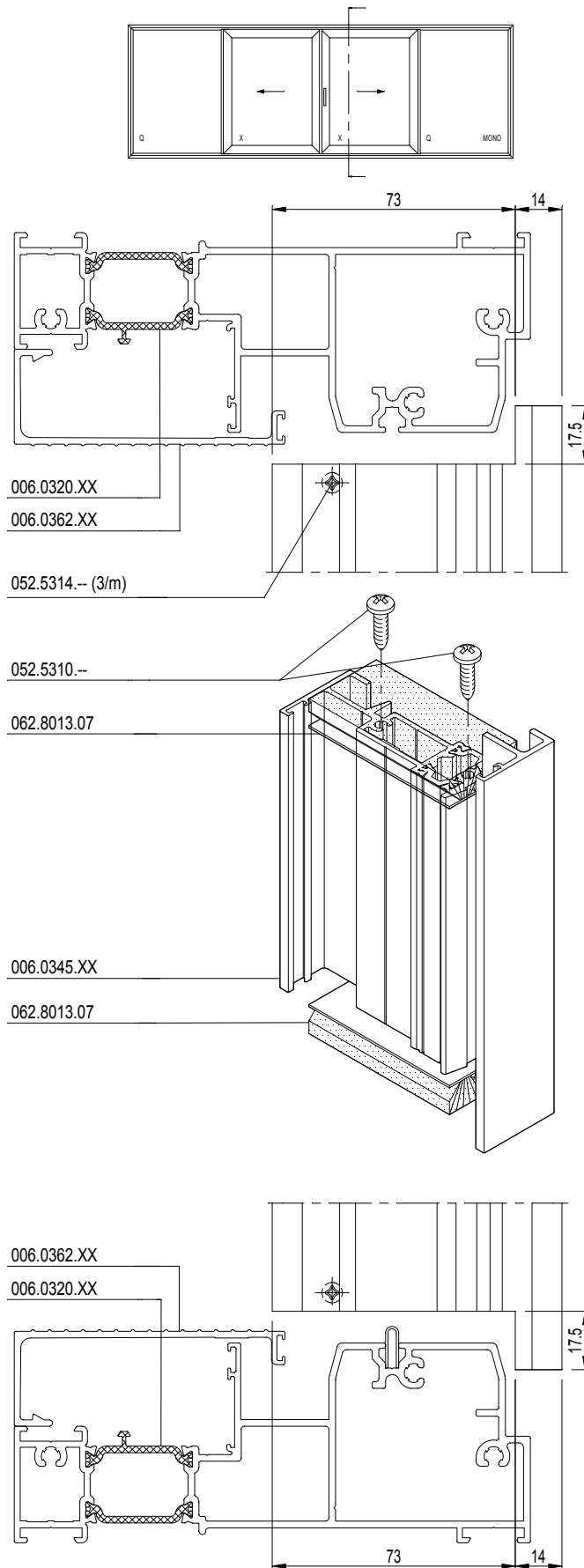

2-RAIL QXXQ

2-RAIL XXXX

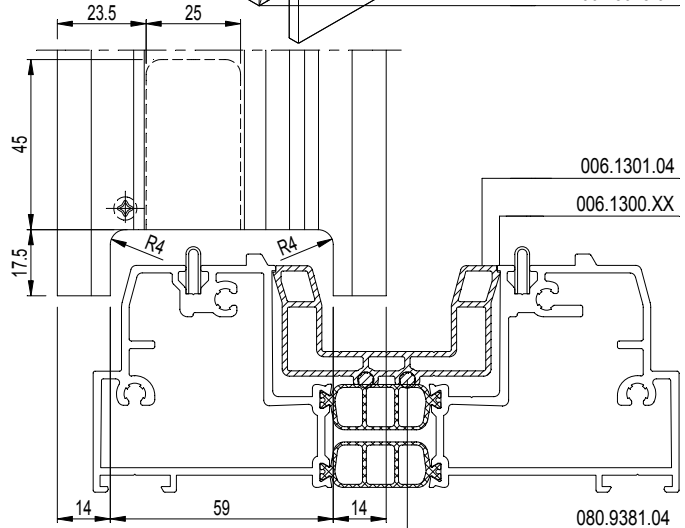
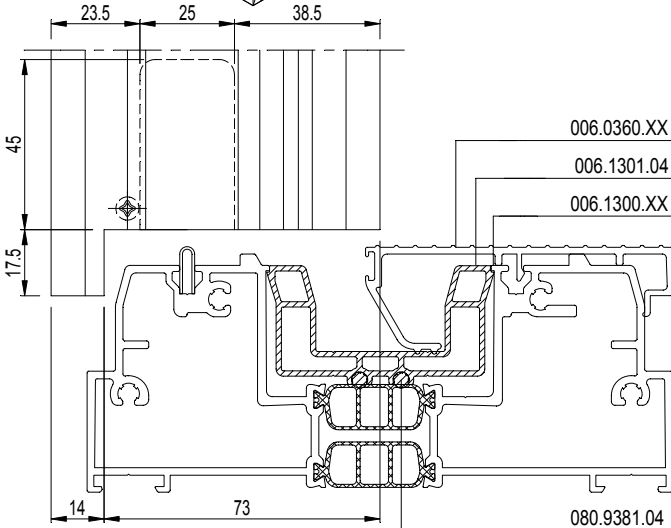
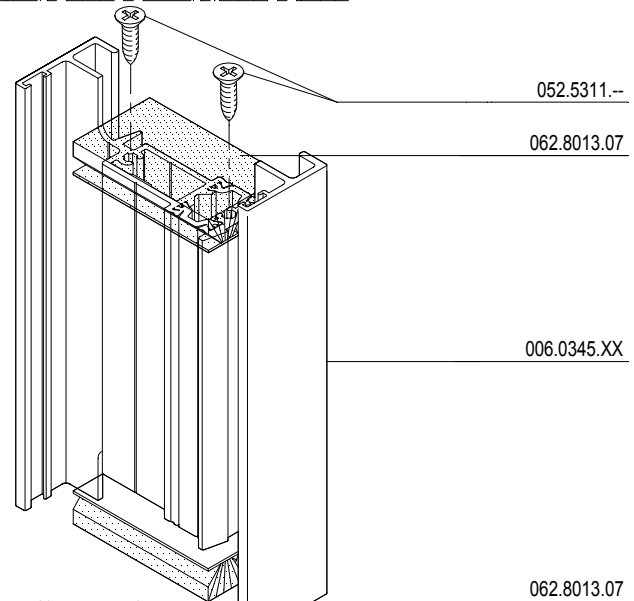
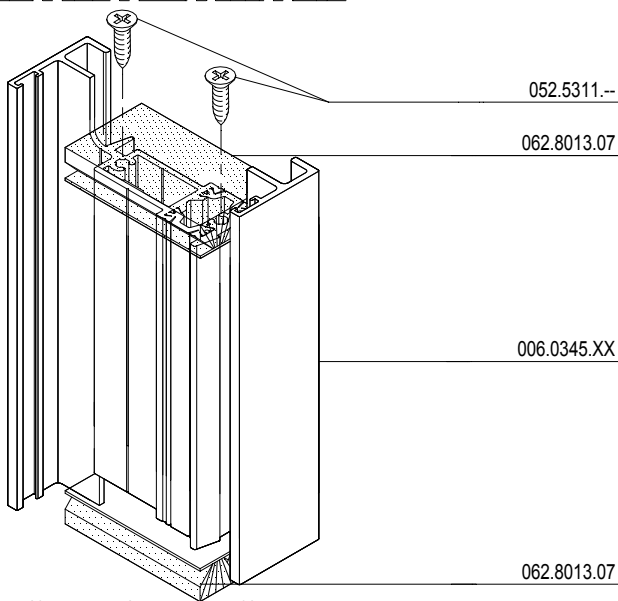
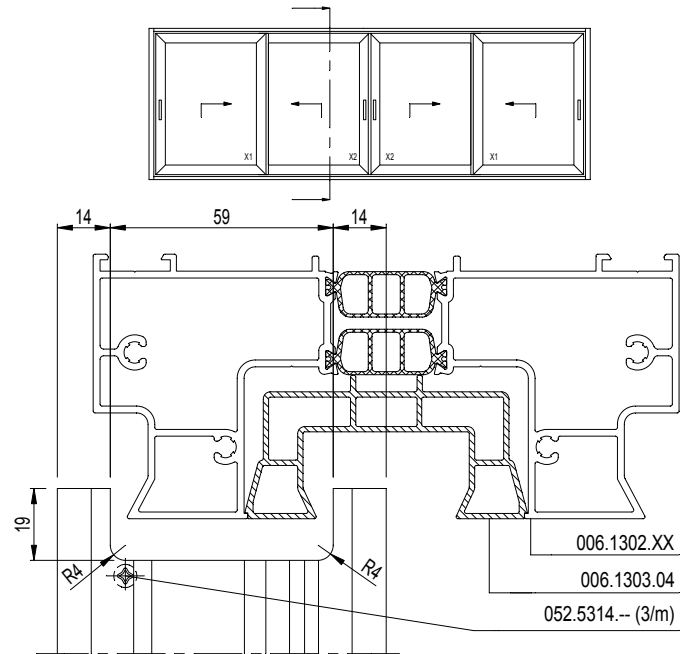
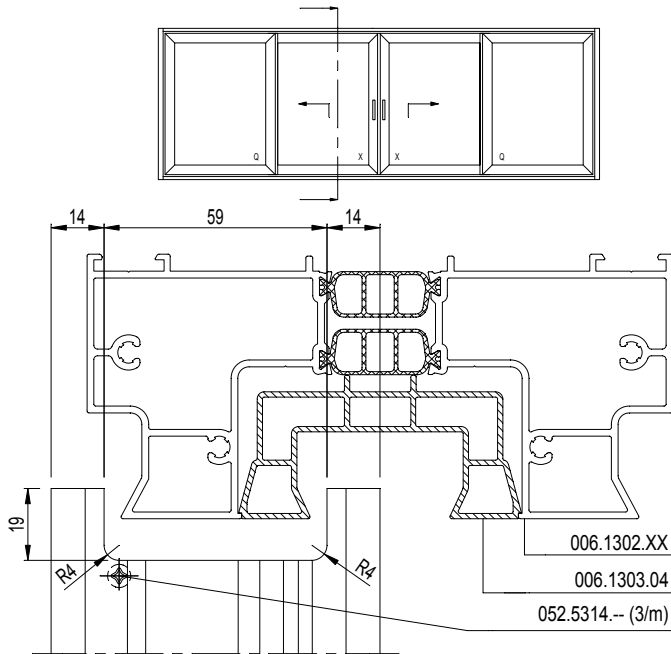

D0013973

MONORAIL QXXQ

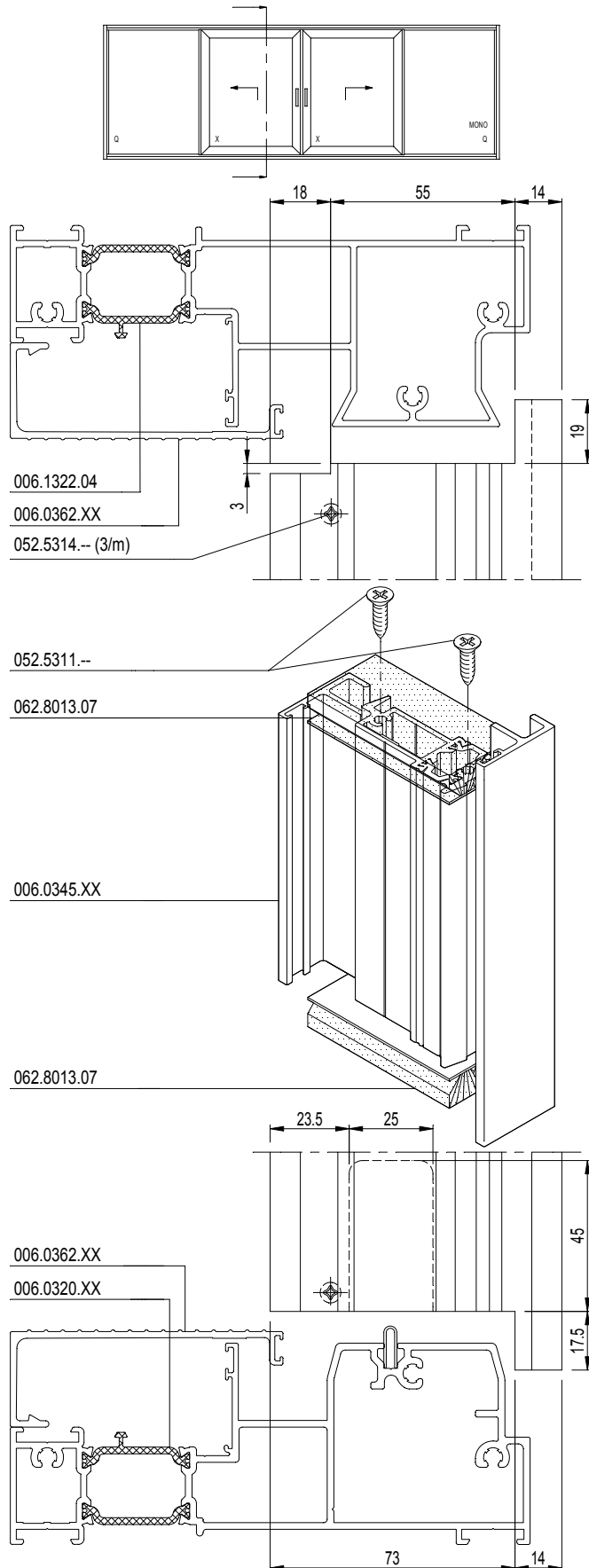

CP 155-LS/HI MINERGIE LABEL

BEWERKEN MIDDENSTIJL 4-SLAG MONORAIL
USINER LIAISON CENTRALE 4 VANTAUX MONORAIL
PROCESSING MEETING STILE 4 DOOR MONORAIL
BEARBEITEN STULPPROFIL TUERFLUEGEL MONORAIL



CP 155-LS/HI MINERGIE LABEL

BEWERKEN MIDDENSTIJL 4-SLAG MONORAIL
USINER LIAISON CENTRALE 4 VANTAUX MONORAIL
PROCESSING MEETING STILE 4 DOOR MONORAIL
BEARBEITEN STULPPROFIL TUERFLUEGEL MONORAIL



MONORAIL QXXQ

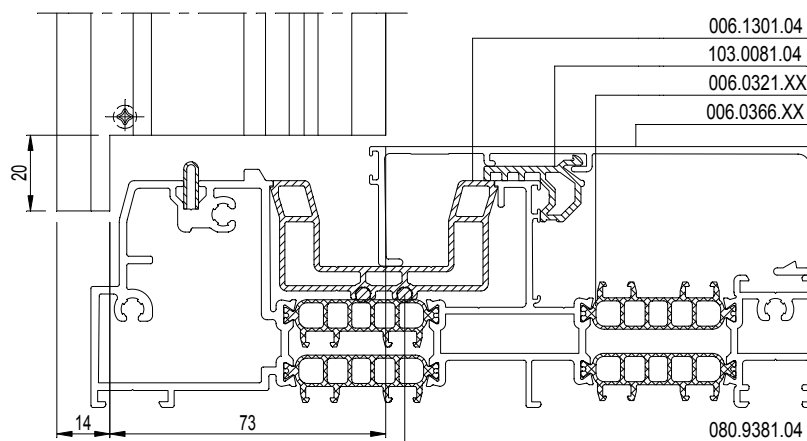
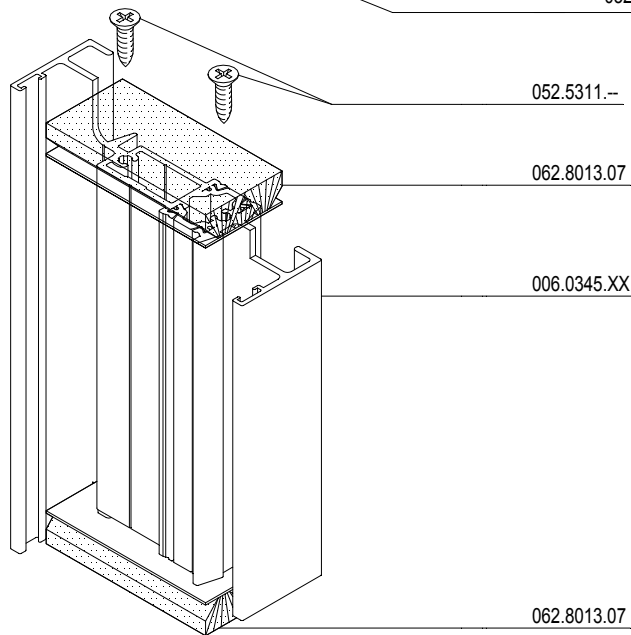
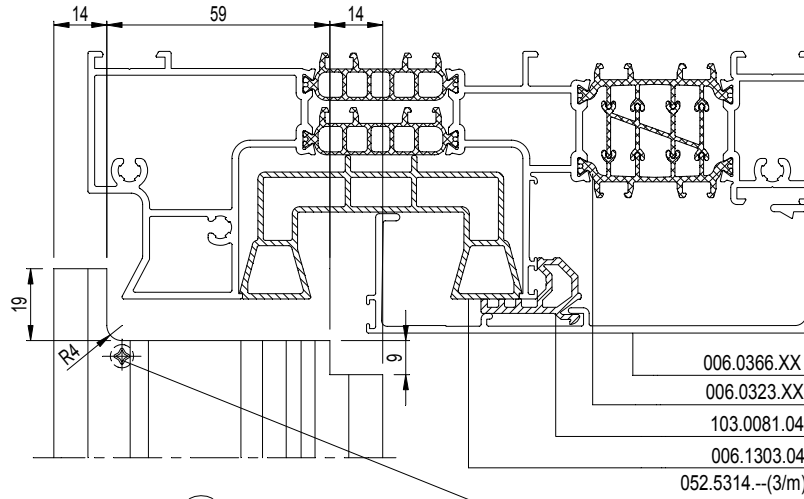
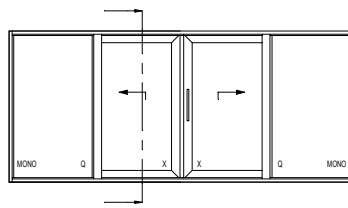

MONORAIL XQ - XQX

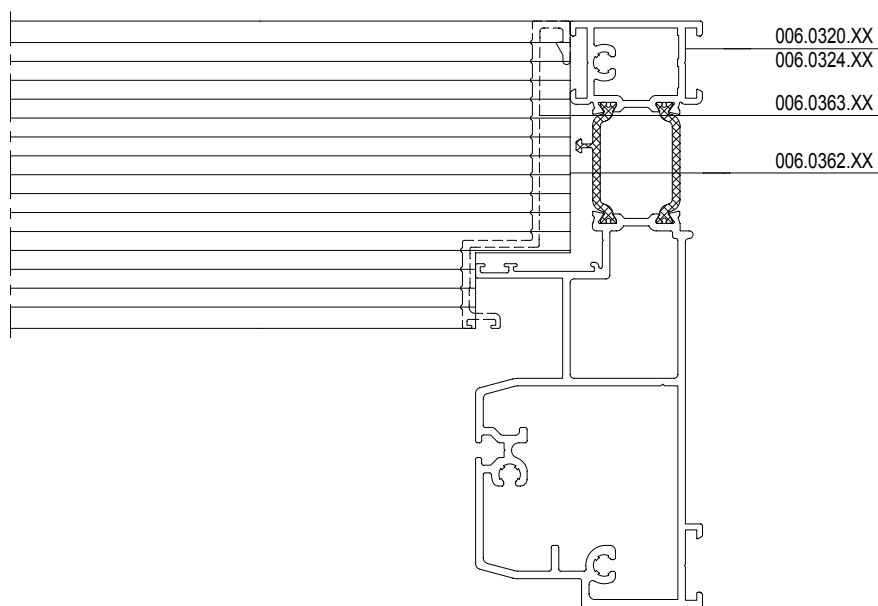
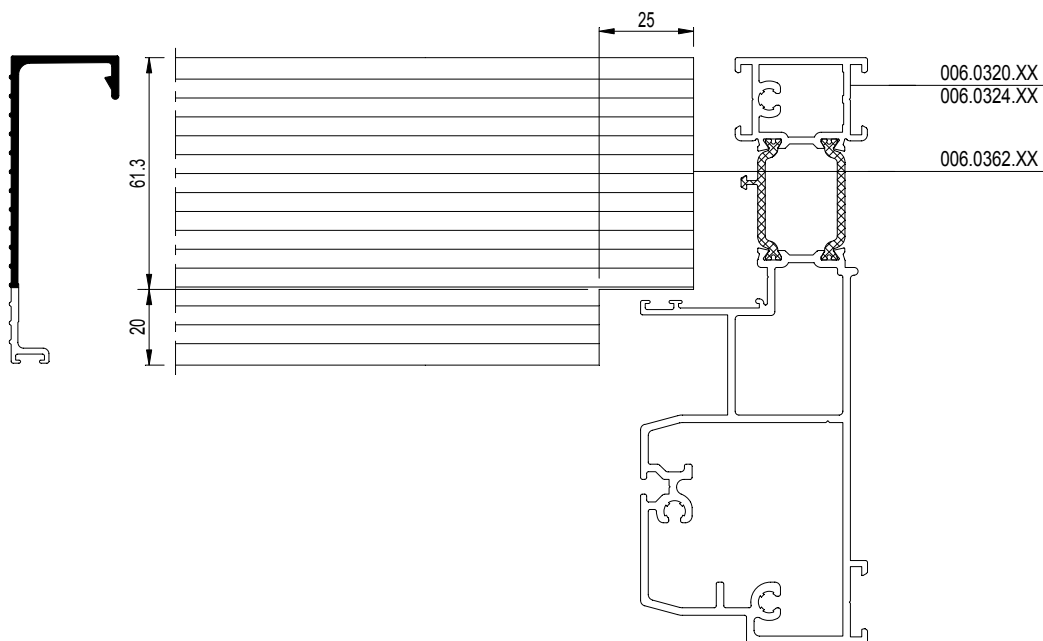
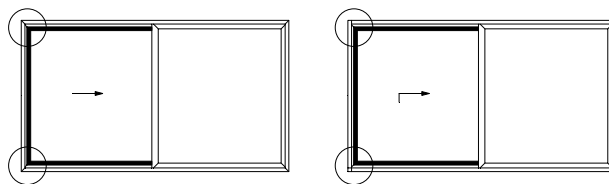

CP 155-LS/Hi MINERGIE LABEL

UITWERKING VLOERPROFIEL MONORAIL
RAINURE PROFILE DE SEUIL MONORAIL
RECESS BOTTOM PROFILE MONORAIL
AUSSPARUNG BODENPROFIL MONORAIL



MONORAIL XQ - XQX - QXQ - QXXQ

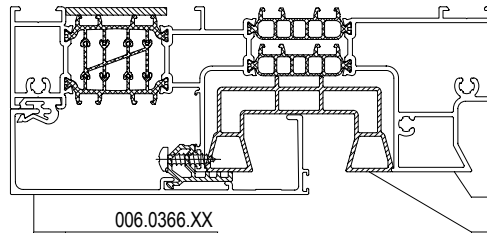
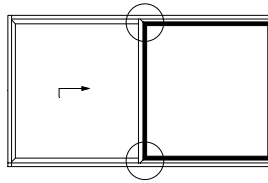

006.0323.XX
006.1303.04

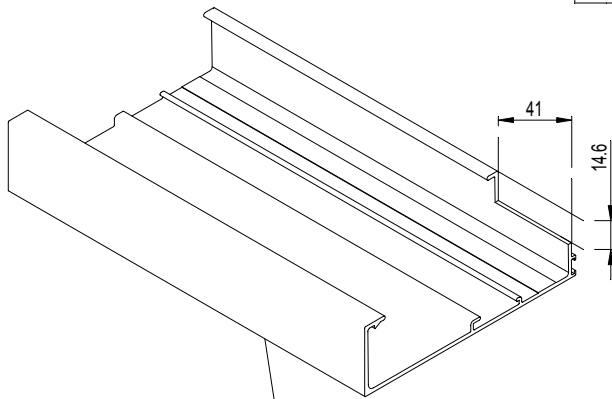

006.0366.XX

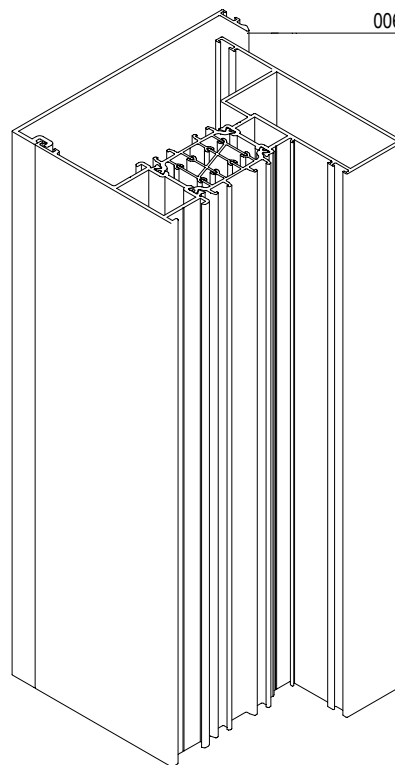

006.0351.XX

006.0350.XX

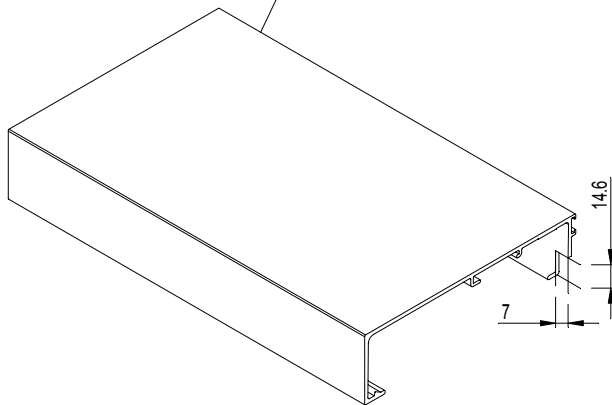

14.6
7

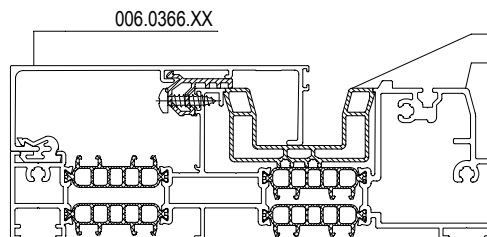

006.0366.XX

006.1301.04
006.0321.XX

MONTAGEVOLGORDE
 L'ORDRE DE MONTAGE
 THE ORDER OF ASSEMBLY
 MONTAGEREIHENFOLGE

1	2	3	.
---	---	---	---

* ZONDER CILINDER
 * SANS CYLINDRE
 * WITHOUT CYLINDER
 * OHNE ZYLINDER

KRUKHOOGTE
 HAUTEUR DE BEQUILLE
 HEIGHT OF HANDLE
 HANDGRIFFHOEHE

1050 mm

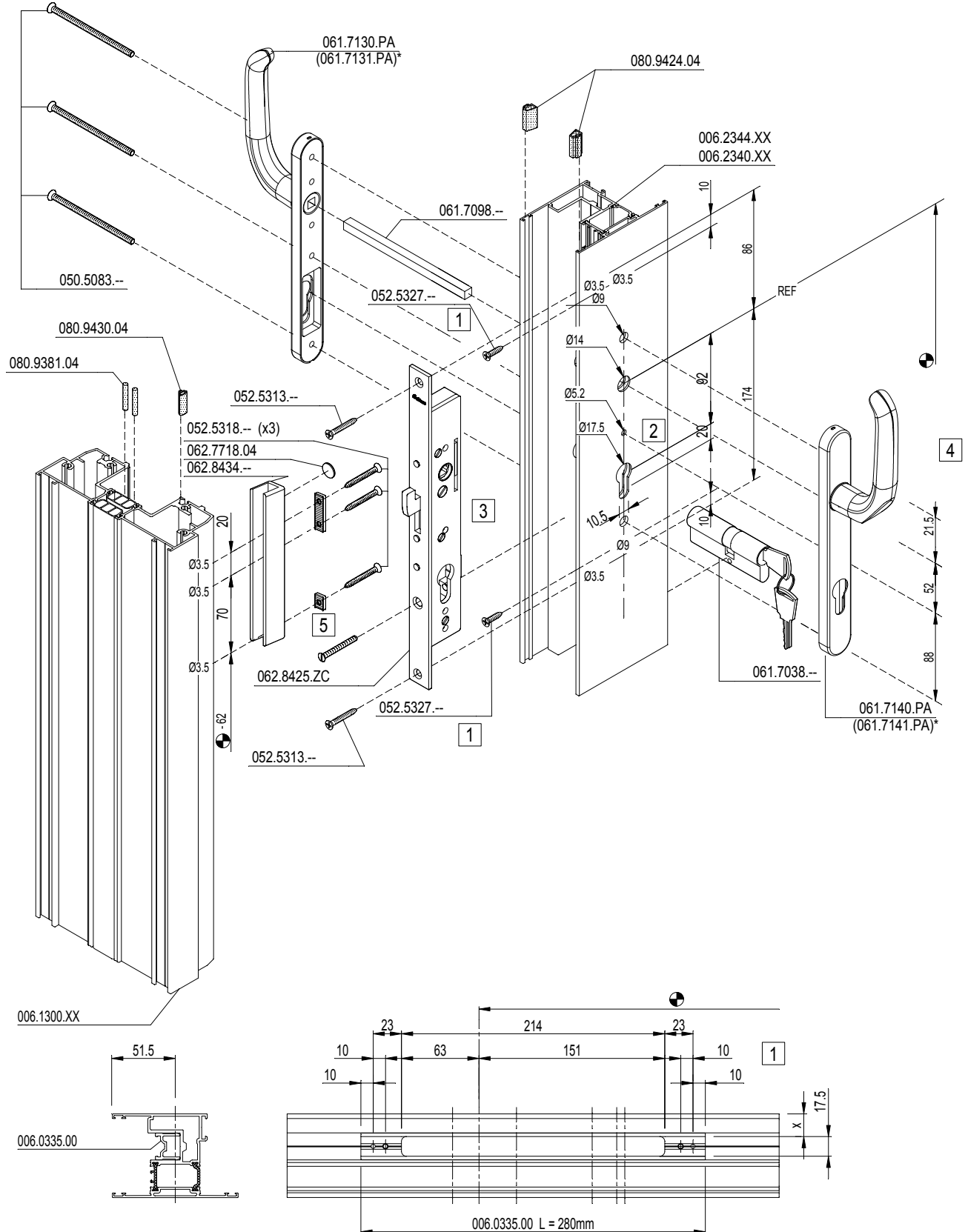
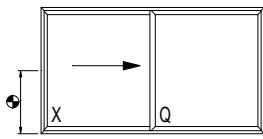

KRUKHOOGTE
 HAUTEUR DE BEQUILLE
 HEIGHT OF HANDLE
 HANDGRIFFHOEHE **1050 mm**

- * ZONDER CILINDER
- * SANS CYLINDRE
- * WITHOUT CYLINDER
- * OHNE ZYLINDER

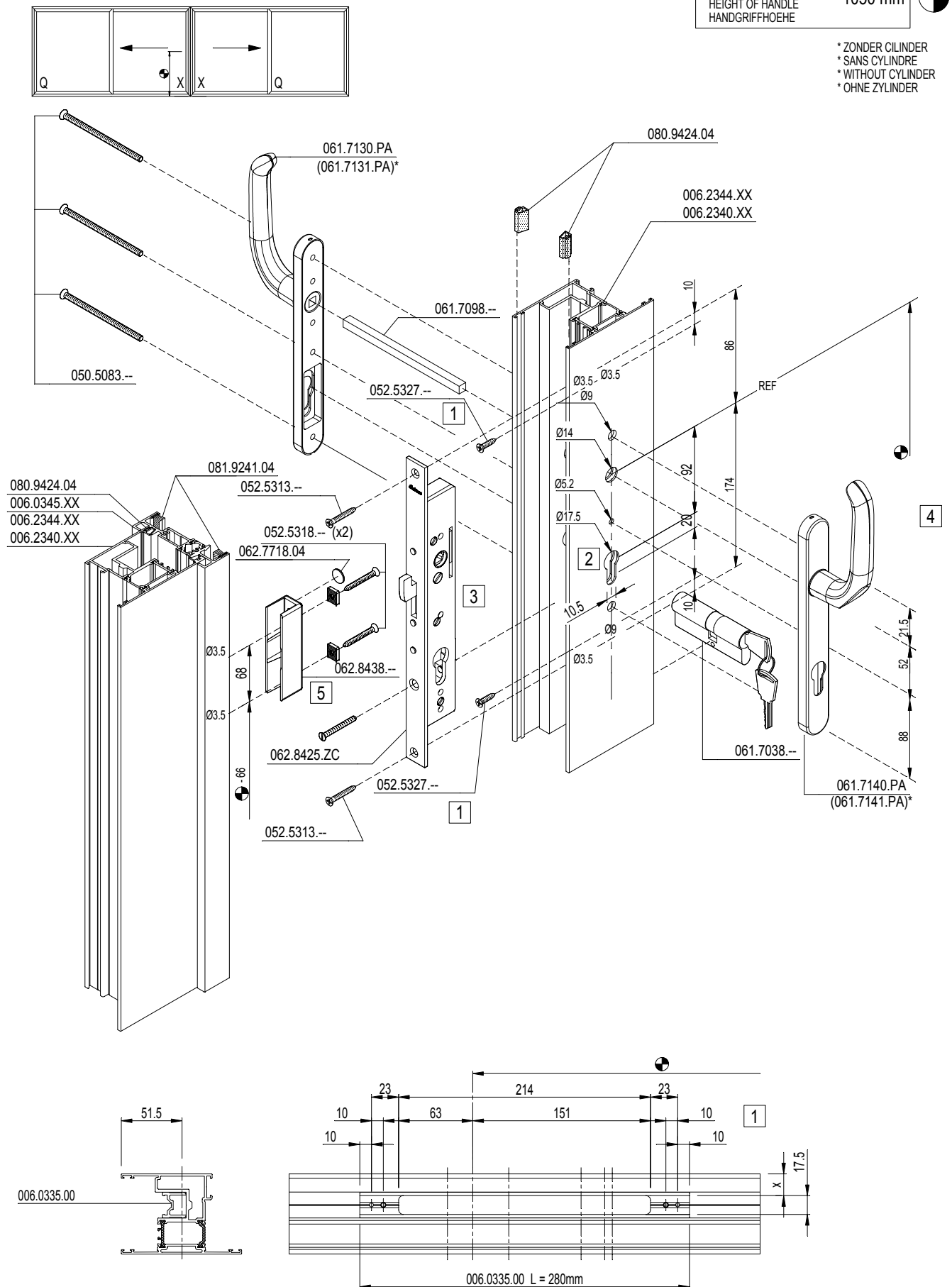

A - A

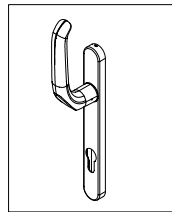
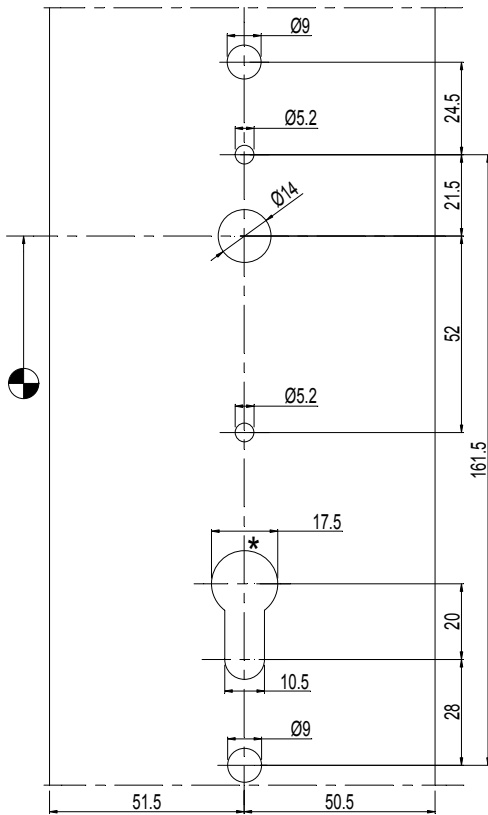

DEURKROK
 BEQUILLE
 DOOR HANDLE
 TUERDRUECKER

061.7130.PA
 *061.7131.PA
 061.7140.PA
 *061.7141.PA

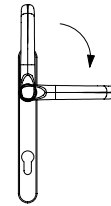

B - B

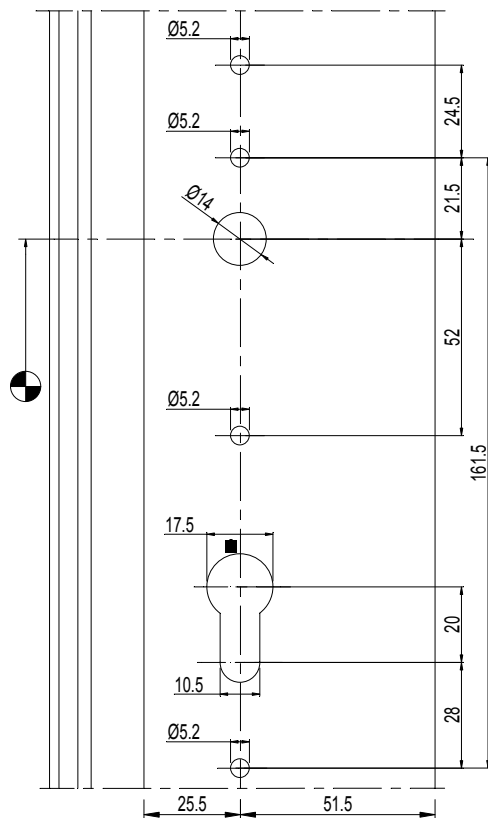

B
↓

↑
A

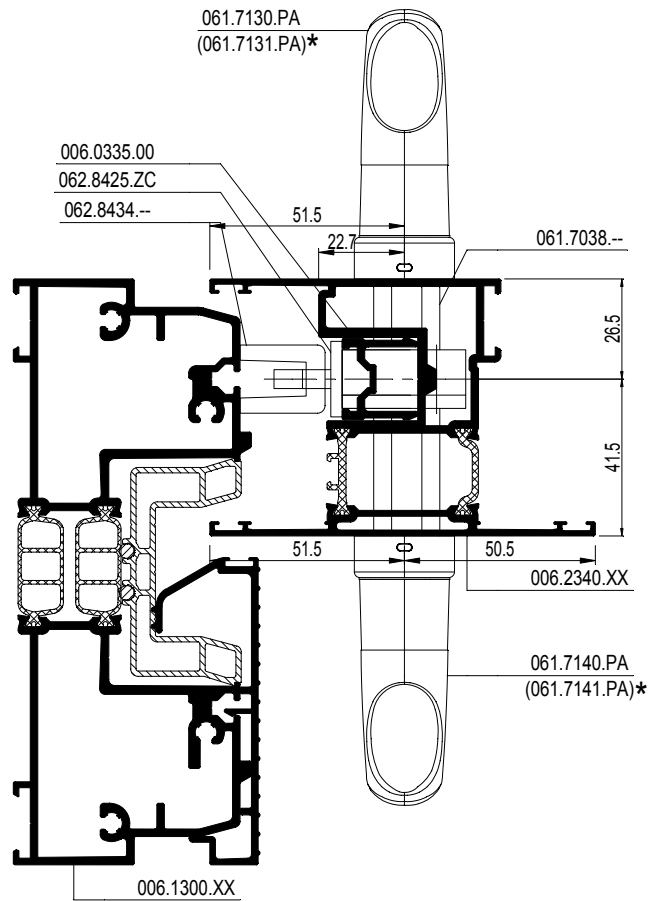

B
↓

↑
A

KROKHOOGTE
 HAUTEUR DE BEQUILLE
 HEIGHT OF HANDLE
 HANDGRIFFHOEHE

1050 mm



* ZONDER CILINDER
 * SANS CYLINDRE
 * WITHOUT CYLINDER
 * OHNE ZYLINDER

A - A

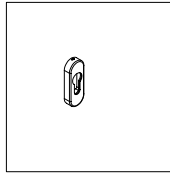
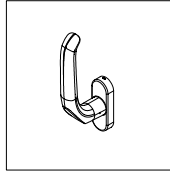
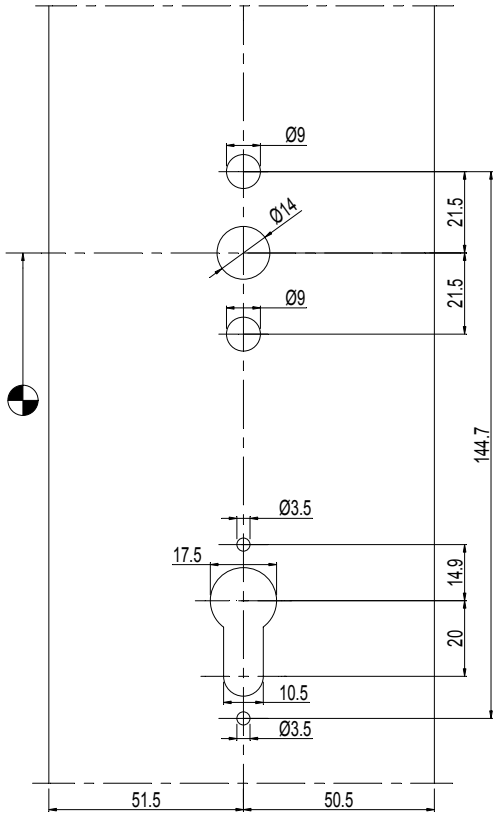

DEURKRUK
 BEQUILLE
 DOOR HANDLE
 TUERDRUECKER

061.7132.PA
 061.7142.PA
 061.6992.PA

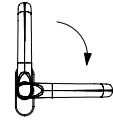

B - B

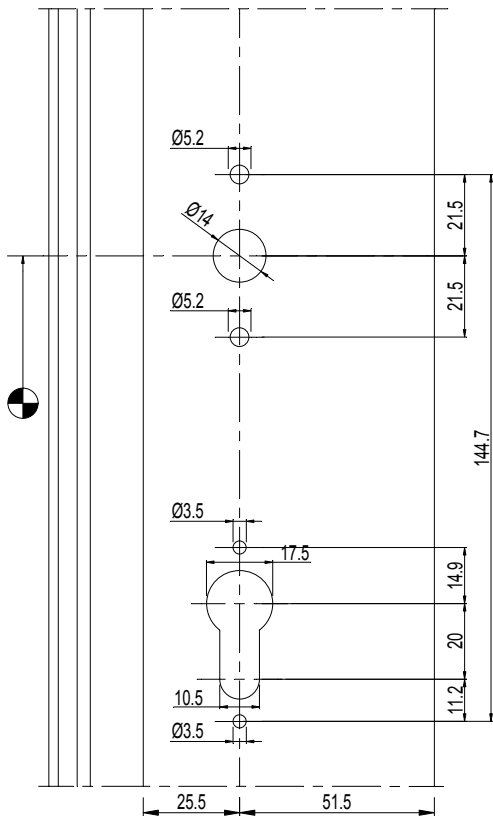

B

A

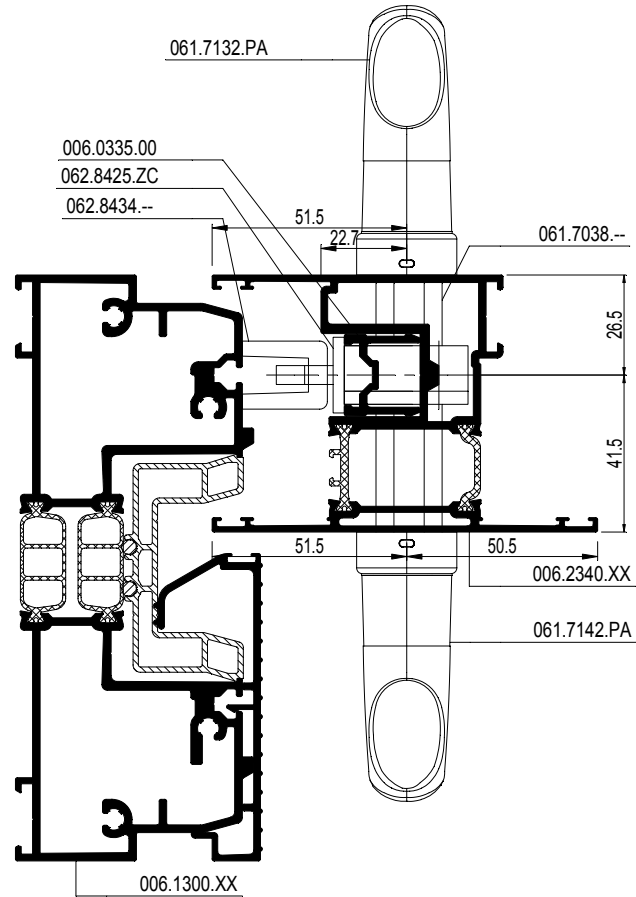

B

A

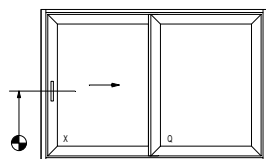

Referentiemaat
 Dimension de référence
 Reference dimension
 Referenzmass

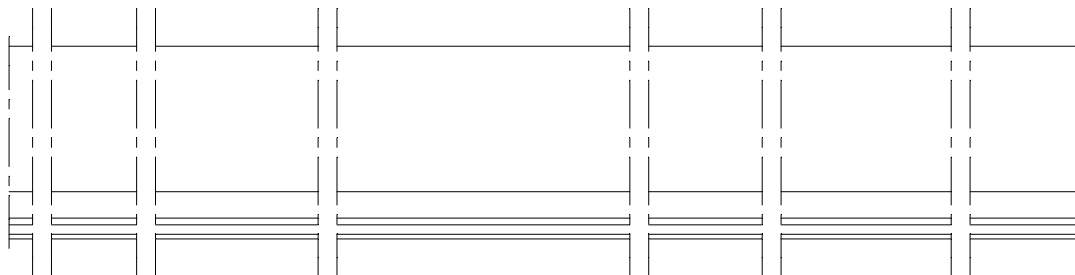
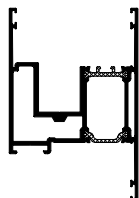

062.8426.ZC

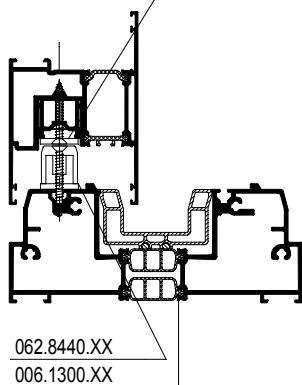

062.8440.XX
 006.1300.XX

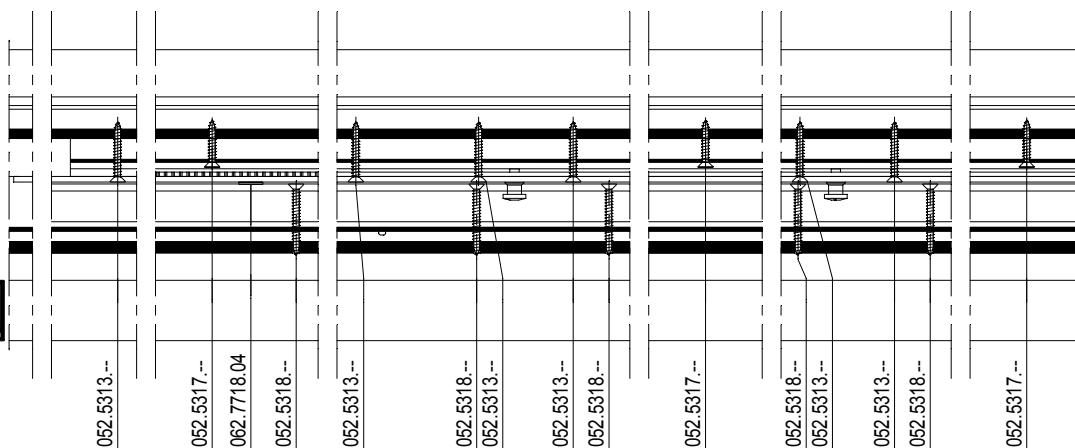

006.2340.XX
 006.0335.00

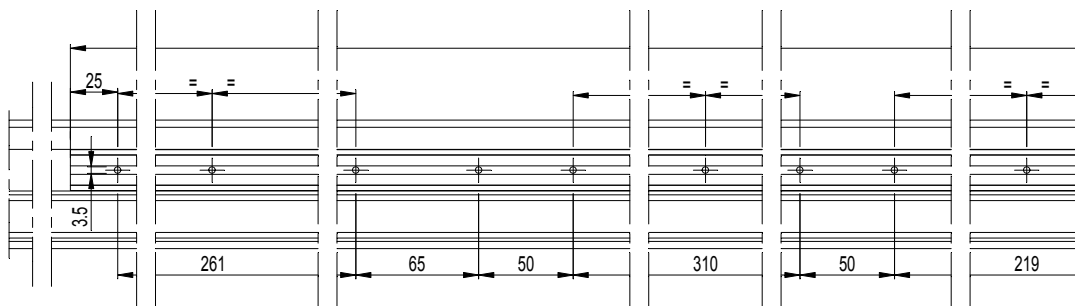
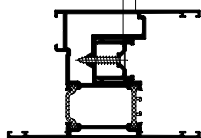

006.1301.04
 006.1300.XX

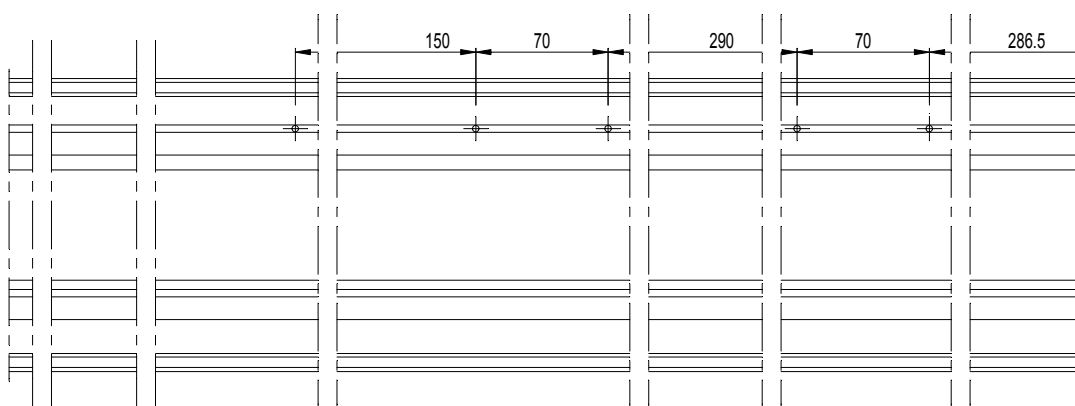
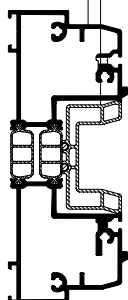

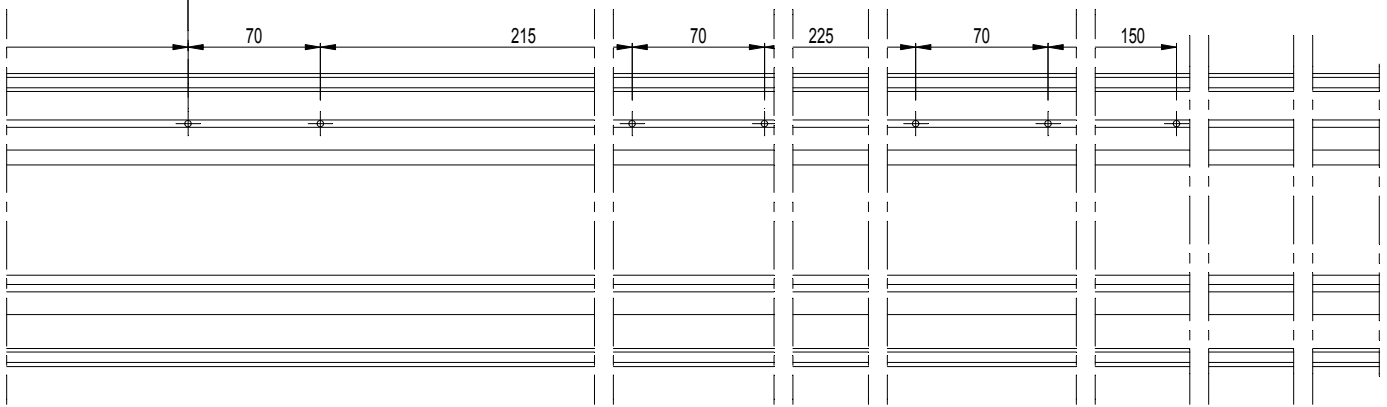
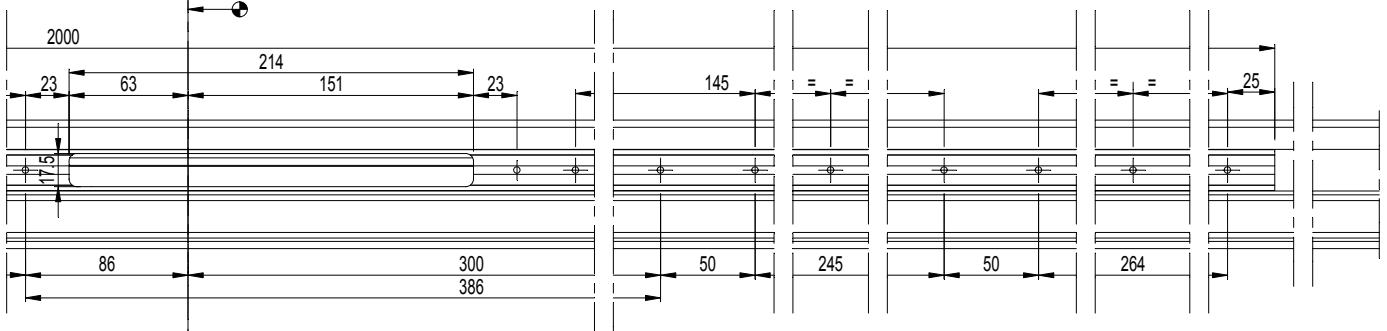
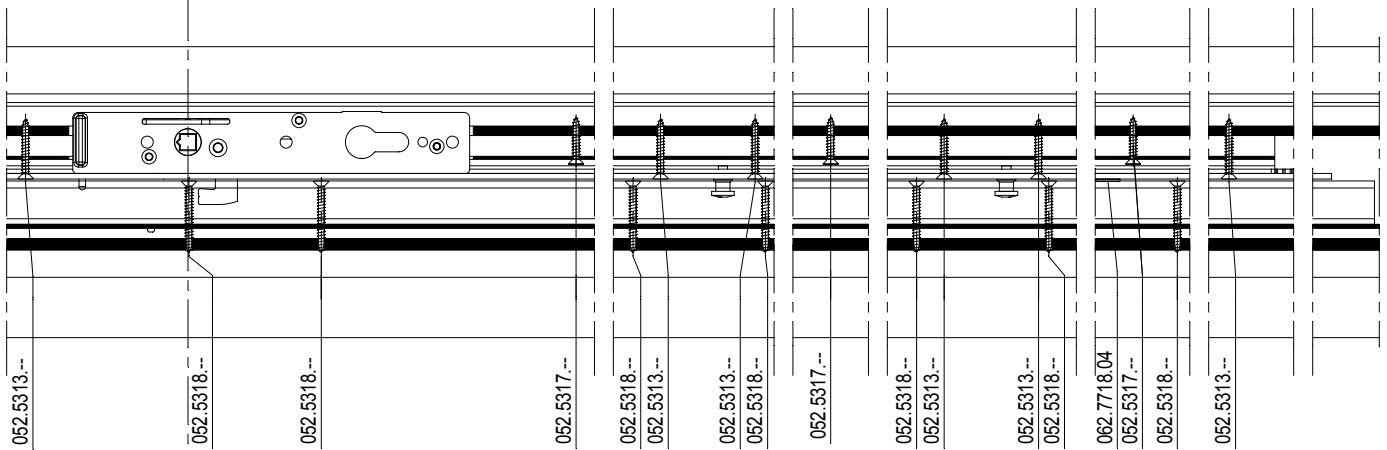
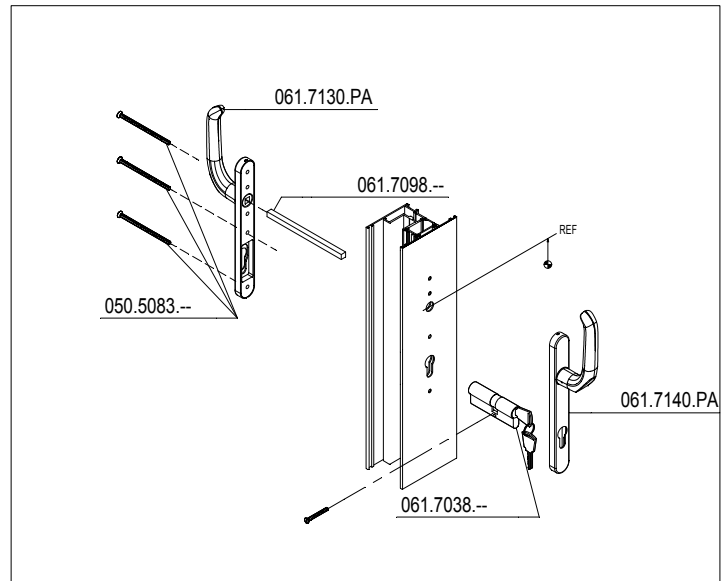
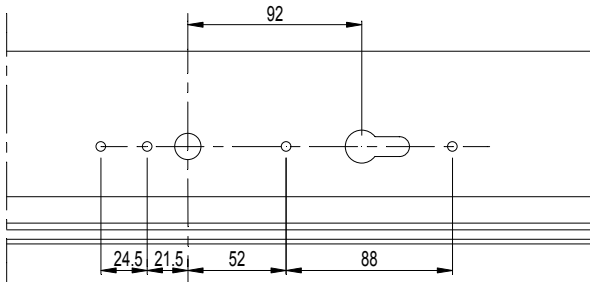

CP 155-LS

INBOUW BASISSET HEFSCHUIFDEUR
 ENCASTREMENT PIECES DE BASE SOULEV. COULISSANT
 EMBEDDING BASIC SET LIFT AND SLIDING DOOR
 EINBAU GRUNDKARTON HEBESCHIEBETUER

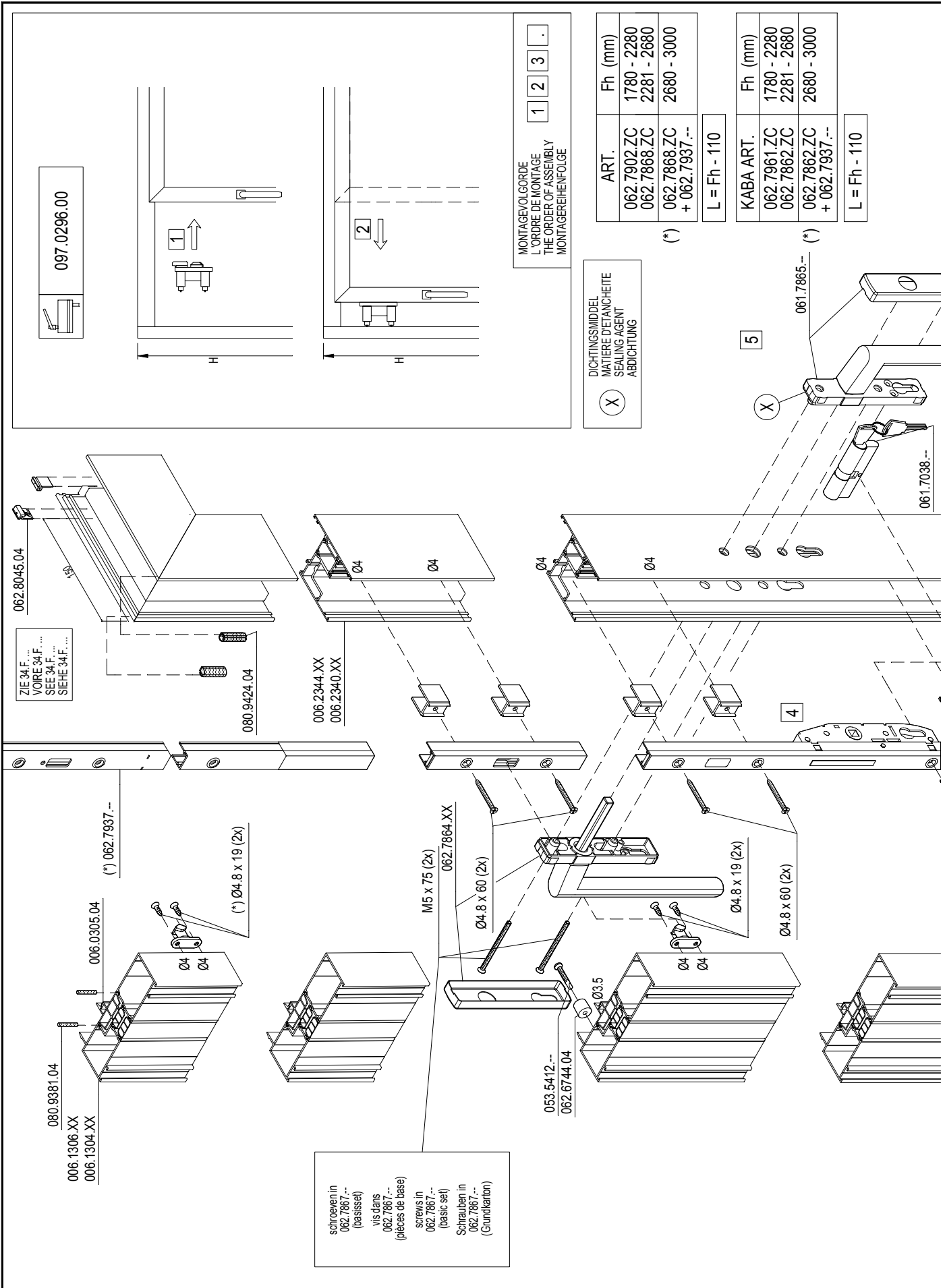

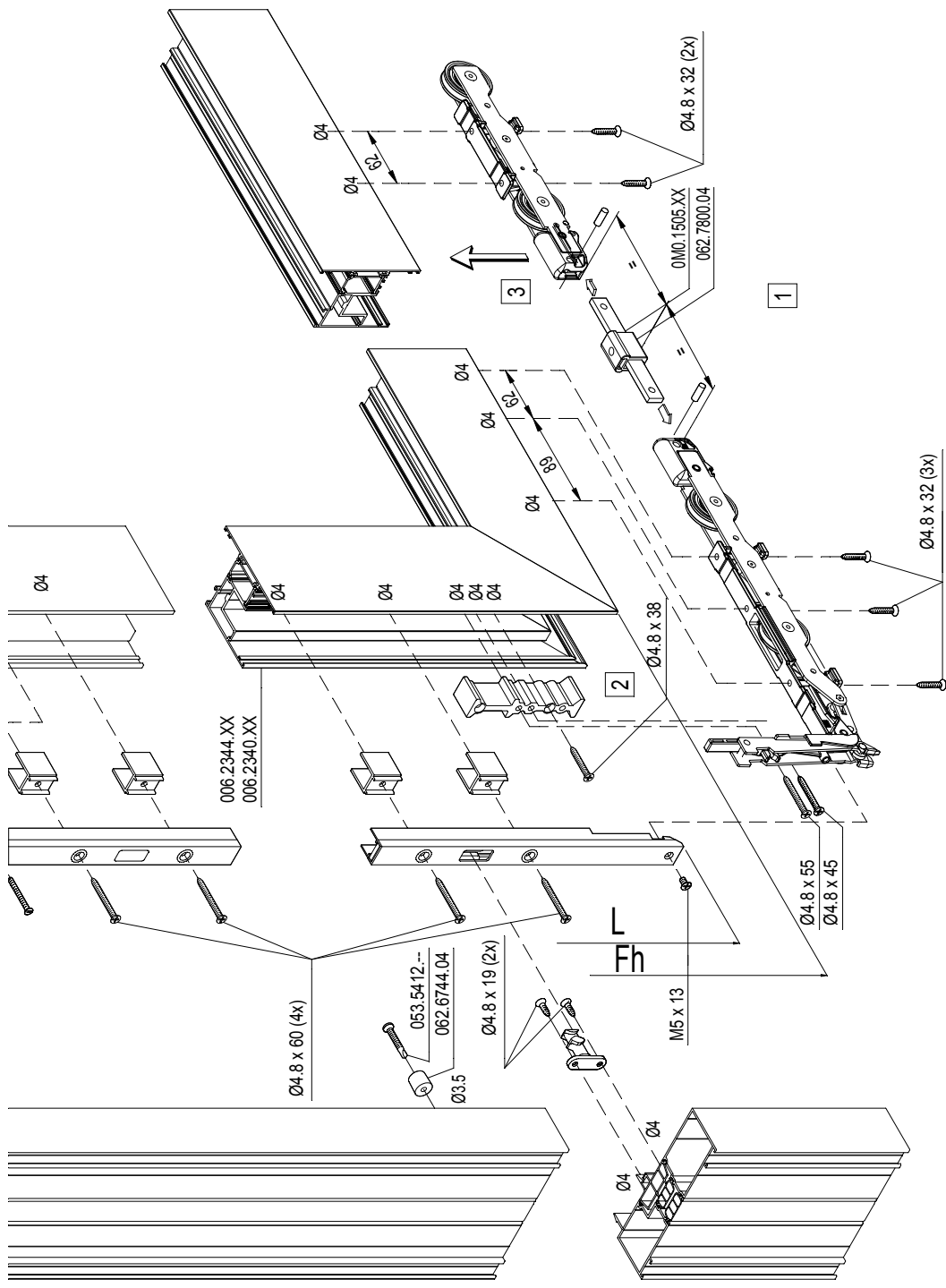

ØM0.1505.XX

Zie blz. 34.E. ... (XQ/XX)
 Voir page 34.E. ... (XQ/XX)
 See page 34.E. ... (XQ/XX)
 Siehe Seite 34.E. ... (XQ/XX)

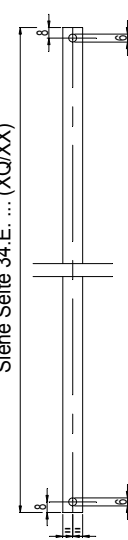

- MONTAGE/OLGORDE
 L'ORDRE DE MONTAGE
 THE ORDER OF ASSEMBLY
 MONTAGEREIHENFOLGE
- 1
 - 2
 - 3

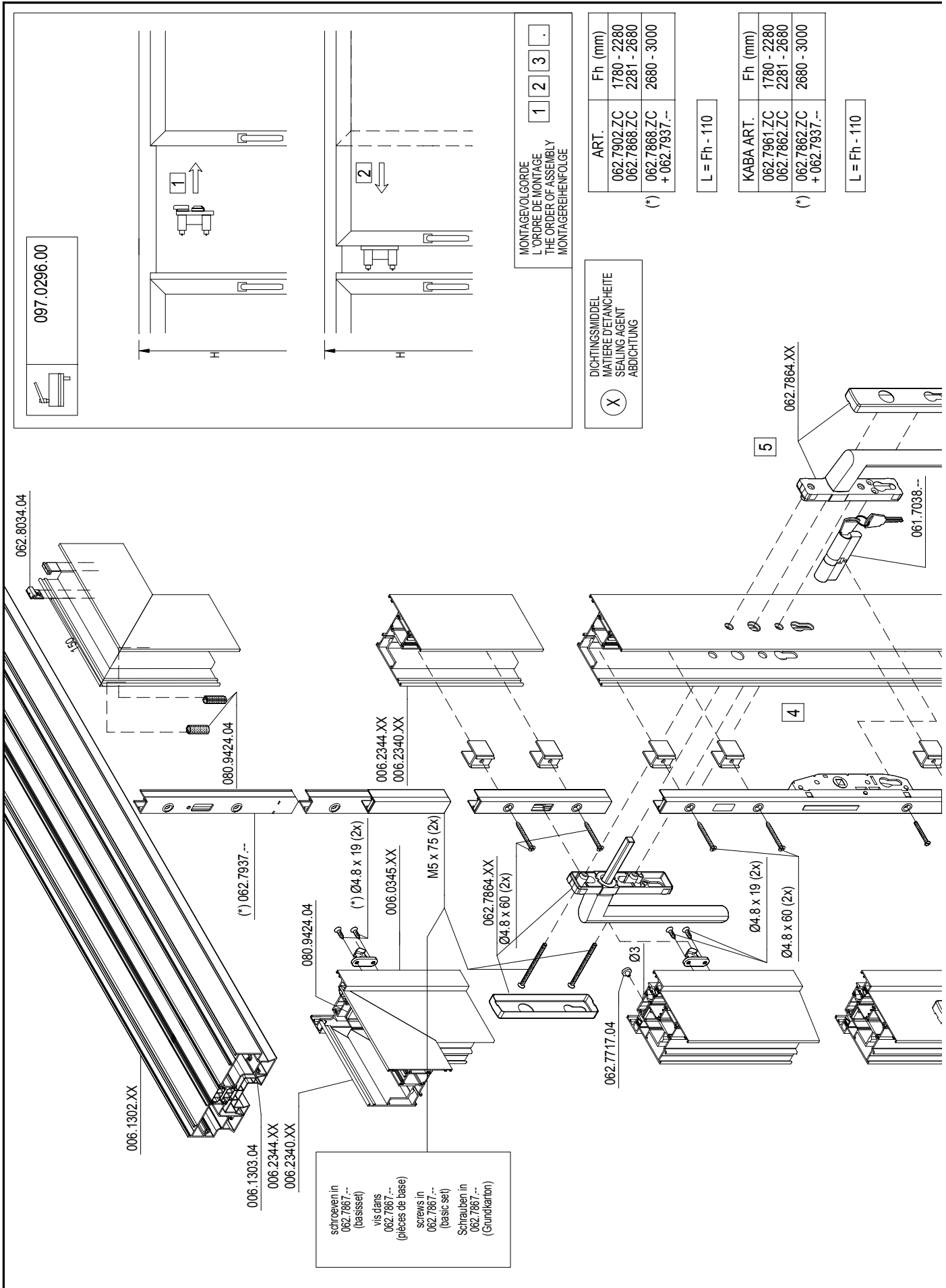

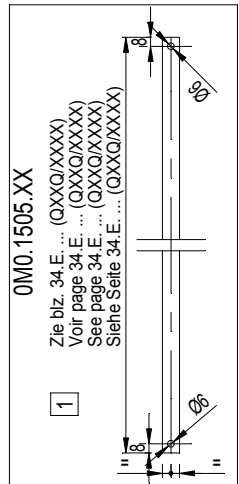
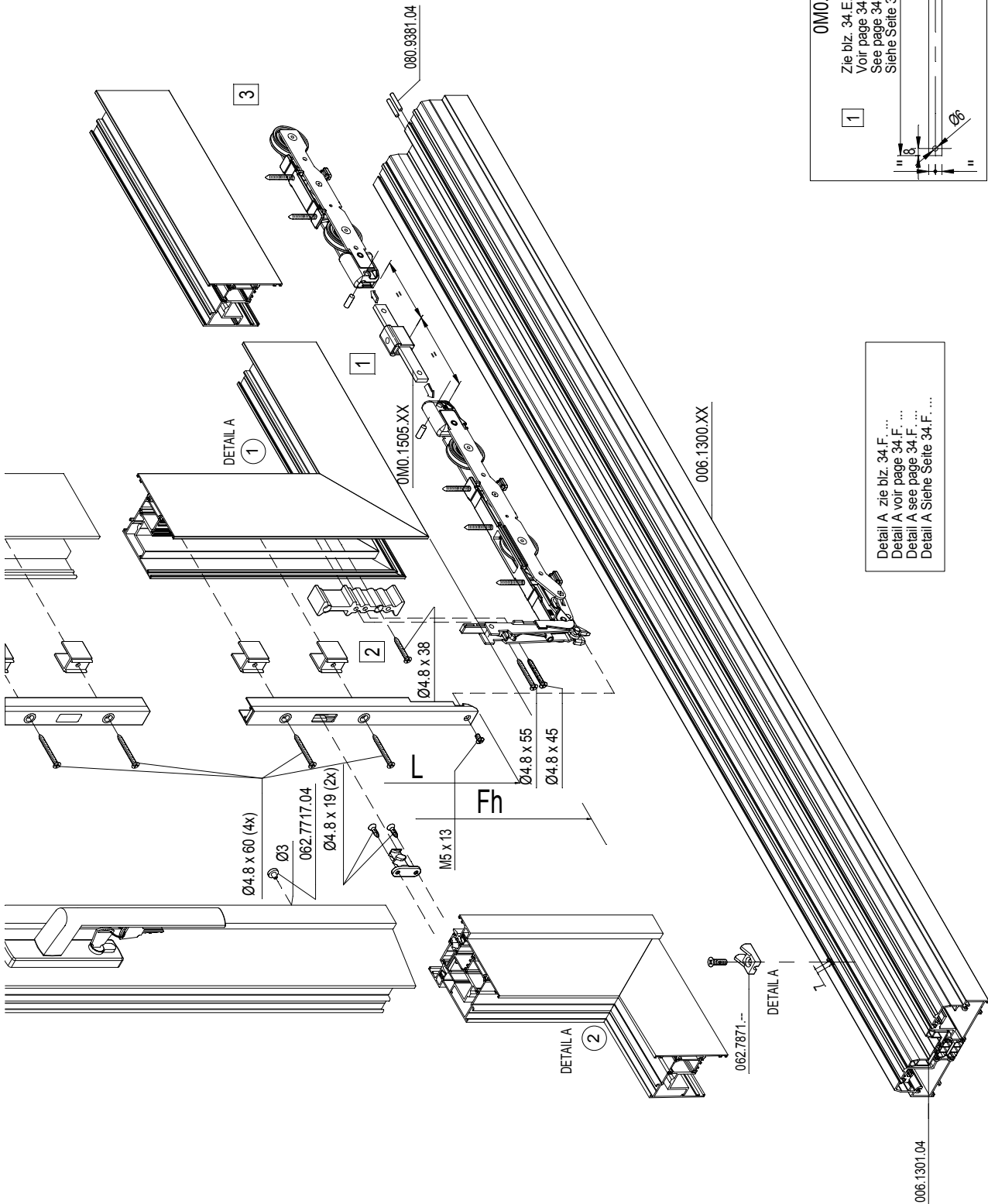

OMO.1505.XX

Zie blz. 34.E. ... (XXXX/XXXX)
 Voir page 34.E. ... (XX/XXXX)
 See page 34.E. ... (XX/XXXX)
 Siehe Seite 34.E. ... (XXXX/XXXX)

1

MONTAGEVOLGORDE
 L'ORDRE DE MONTAGE
 THE ORDER OF ASSEMBLY
 MONTAGEREIHENFOLGE

1 2 3

Detail A zie blz. 34.F. ...
 Detail A voir page 34.F. ...
 Detail A see page 34.F. ...
 Detail A Siehe Seite 34.F. ...

CP 155 CP 155-LS

INBOUW BASISSET HEFSCHUIFDEUR 4-SLAG MIN. 300KG MAX. 400KG
 ENCASTREMENT PIECES DE BASE SOULEV. COULISS. 4-VANT. MIN. 300KG MAX. 400KG
 EMBEDDING BASIC SET LIFT AND SLIDING DOOR 4 DOORS MIN. 300KG MAX. 400KG
 EINBAU GRUNDKARTON HEBESCHIEBETUER 4-SCHLAG MIN. 300KG MAX. 400KG

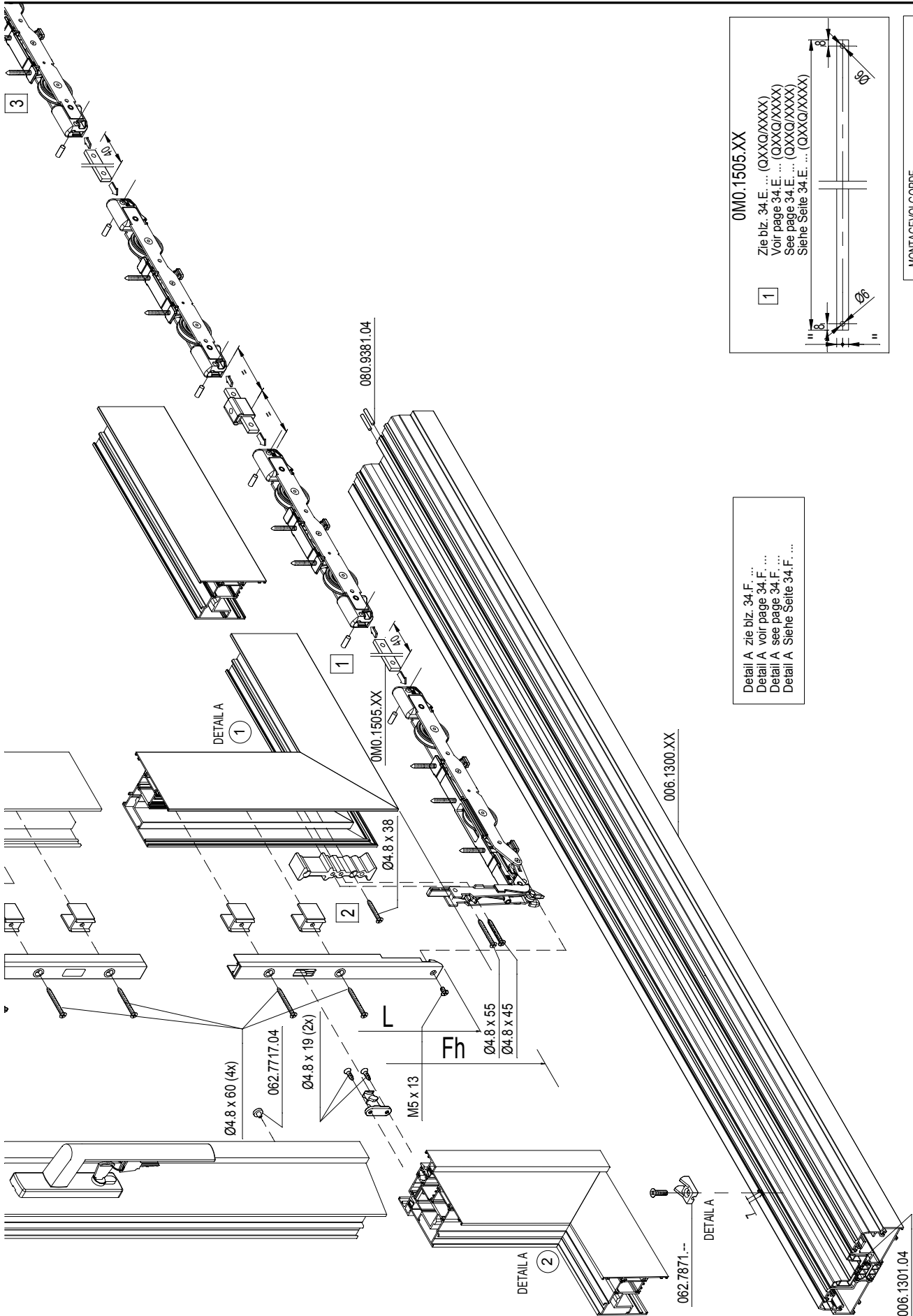

0M0.1505.XX

Zie blz. 34.E. ... (QXXQ/XXXX)
 Voir page 34.E. ... (QXXQ/XXXX)
 See page 34.E. ... (QXXQ/XXXX)
 Siehe Seite 34.E. ... (QXXQ/XXXX)

1

Detail A zie blz. 34.F. ...
 Detail A voir page 34.F. ...
 Detail A see page 34.F. ...
 Detail A Siehe Seite 34.F. ...

- MONTAGEVOLGORDE
 L'ORDRE DE MONTAGE
 THE ORDER OF ASSEMBLY
 MONTAGEREIHENFOLGE
- 1 2 3

CP 155-LS

BASISSET AUTOMATISCHE HEFSCHUIFDEUR
 SET DE BASE SOULEV. COULISSANT AUTOMATIQUE
 BASIC SET AUTOMATIC LIFT AND SLIDING DOOR
 GRUNDKARTON AUTOMATISCHE HEBESCHIEBETUER

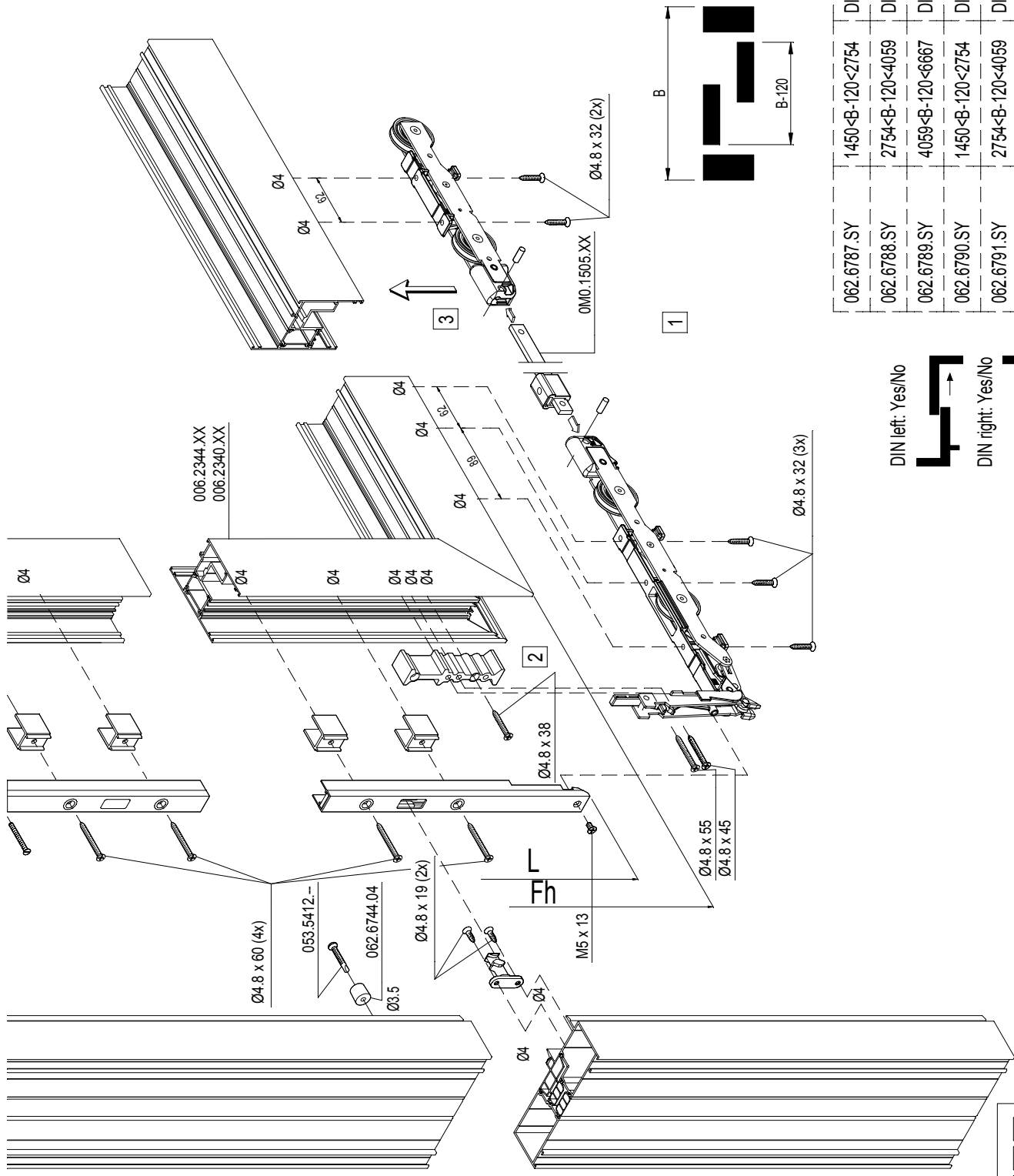

	DINL	DINL	DINL	DINR	DINR	DINR
062.6787.SY	1450<B-120<2754					
062.6788.SY	2754<B-120<4059					
062.6789.SY	4059<B-120<6667					
062.6790.SY	1450<B-120<2754					
062.6791.SY	2754<B-120<4059					
062.6792.SY	4059<B-120<6667					

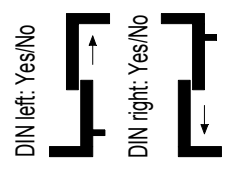

MONTAGE/ORDRE
 L'ORDRE DE MONTAGE
 THE ORDER OF ASSEMBLY
 MONTAGEREIHENFOLGE

1 2 3

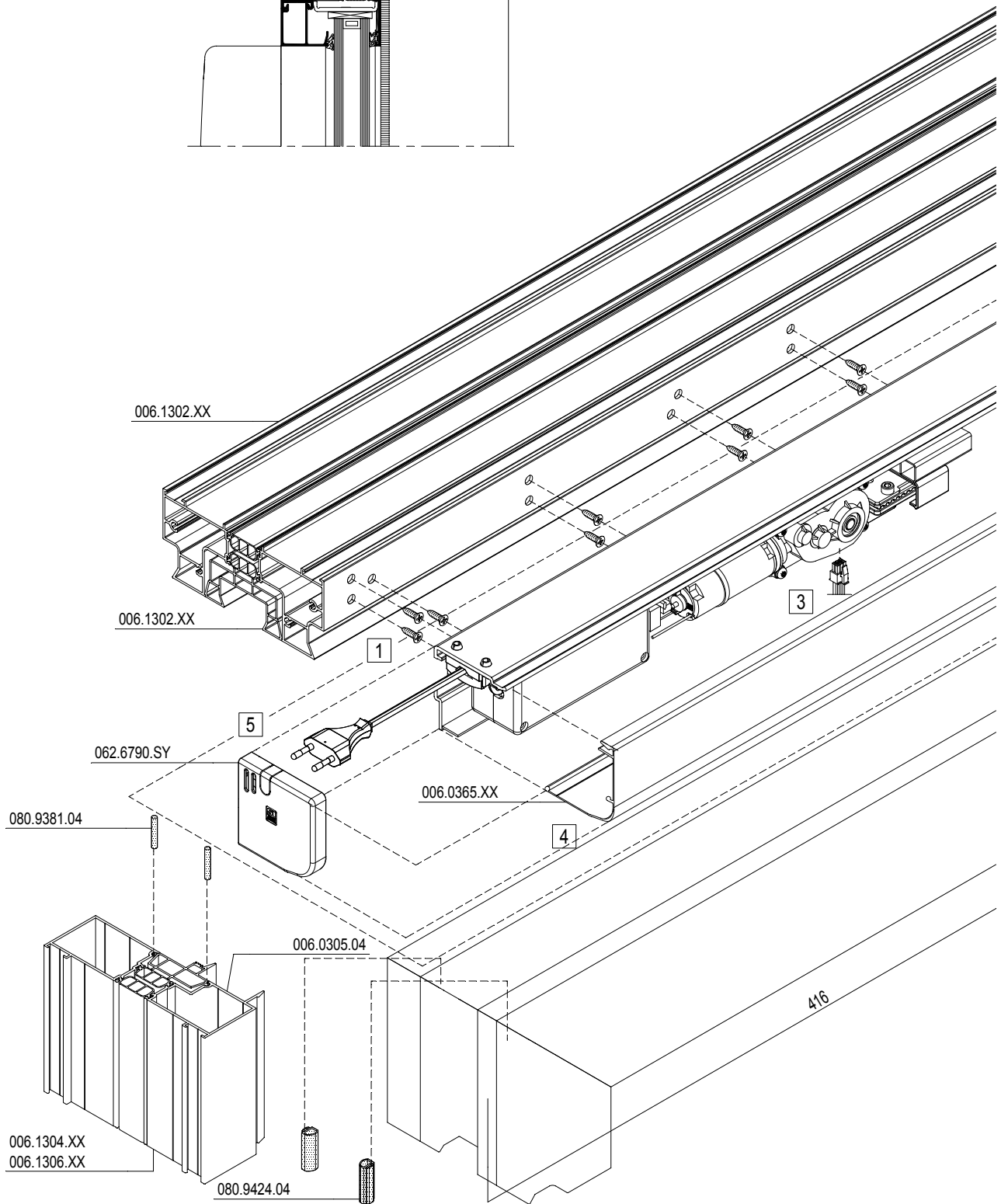
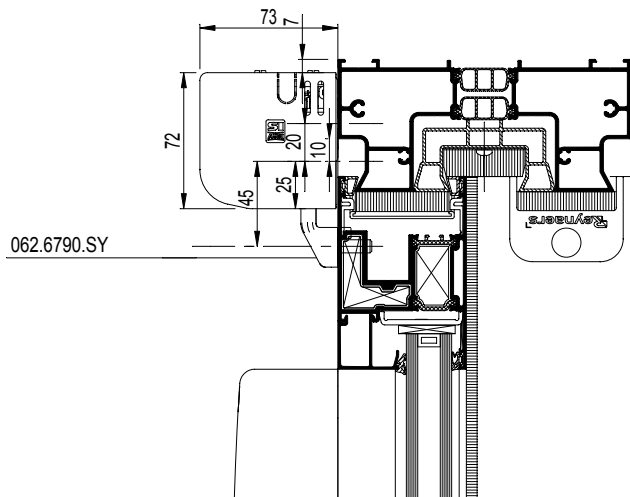

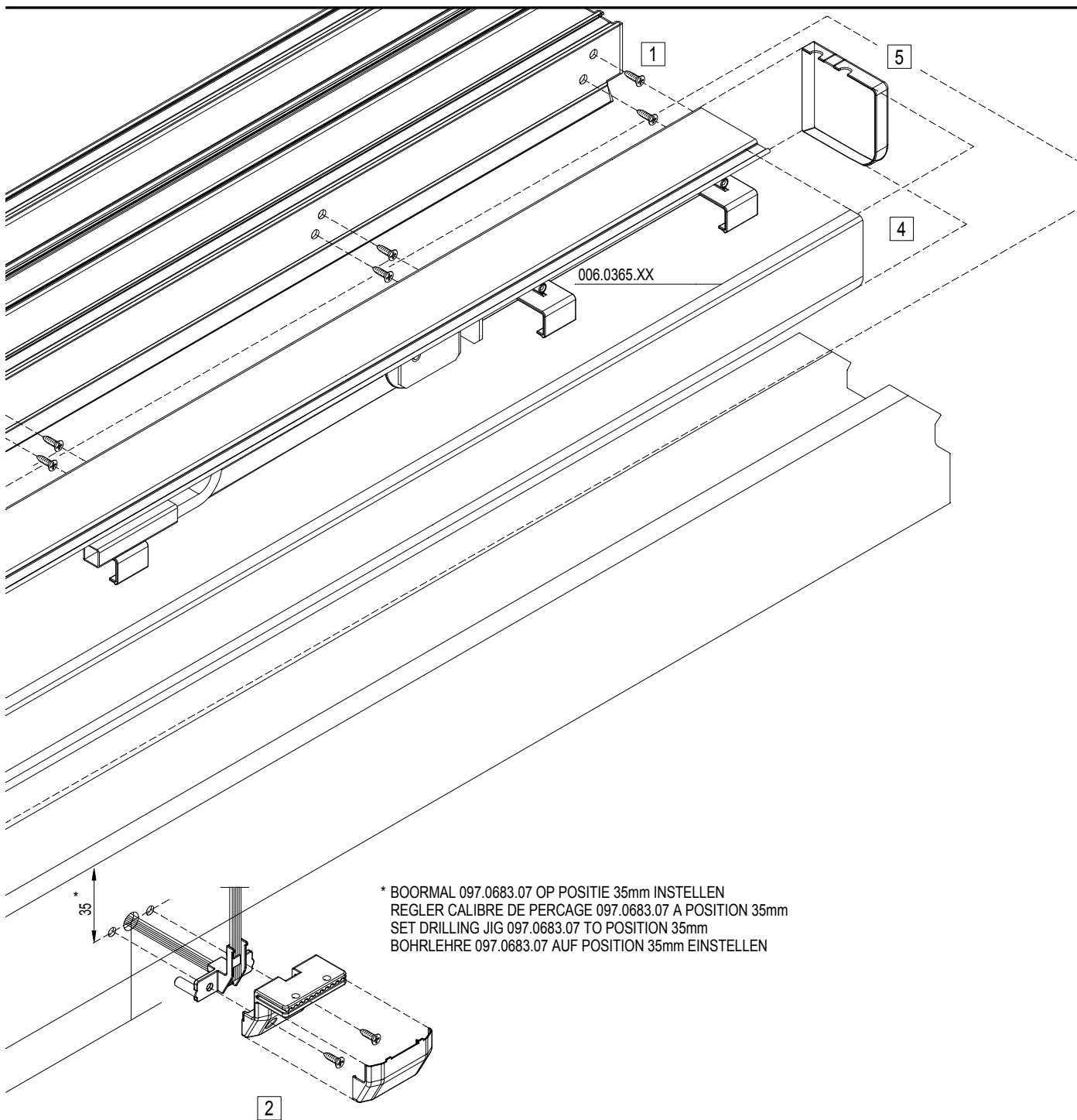

* BOORMAL 097.0683.07 OP POSITIE 35mm INSTELLEN
 REGLER CALIBRE DE PERCAGE 097.0683.07 A POSITION 35mm
 SET DRILLING JIG 097.0683.07 TO POSITION 35mm
 BOHRLEHRE 097.0683.07 AUF POSITION 35mm EINSTELLEN

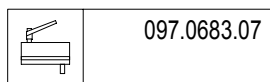

MONTAGEVOLGORDE L'ORDRE DE MONTAGE THE ORDER OF ASSEMBLY MONTAGEREIHENFOLGE	1	2	3	.
--	---	---	---	---

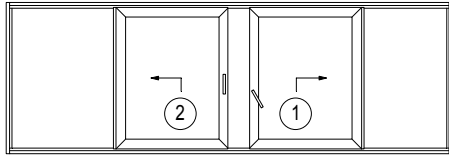

DETAIL A

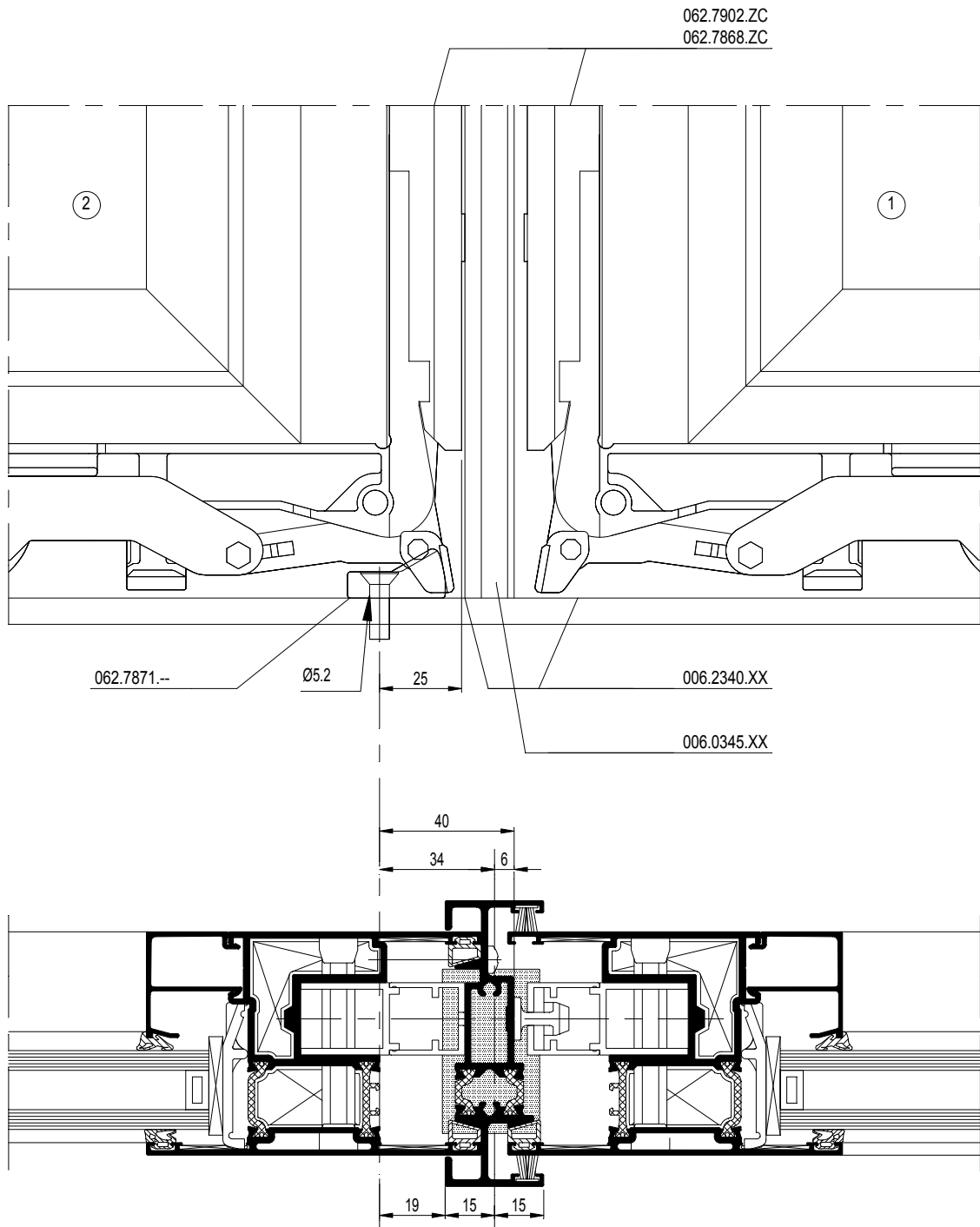

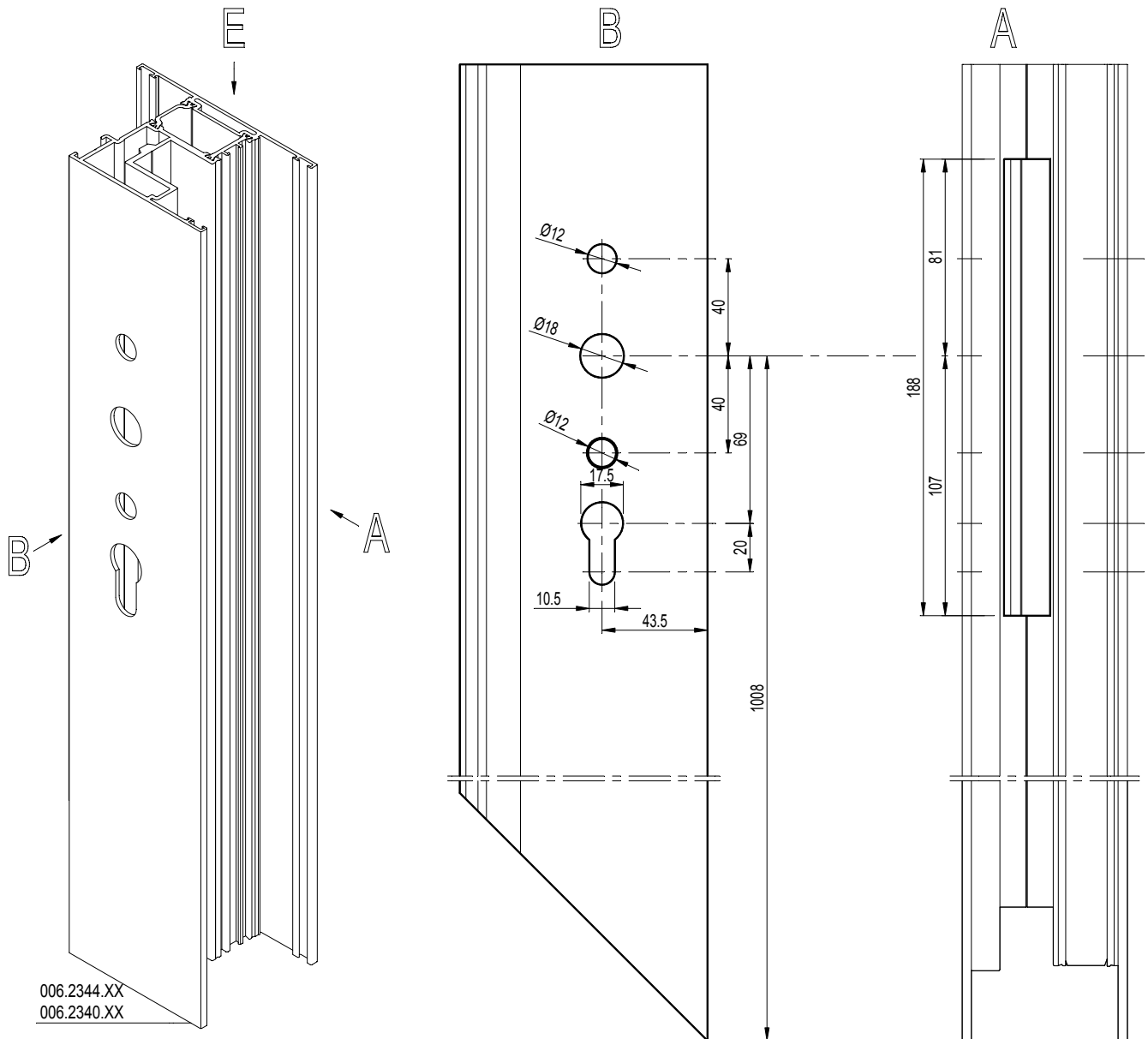

006.2344.XX
 006.2340.XX

	095.A700.00
	095.A730.00
	095.B300.00
	095.B323.00

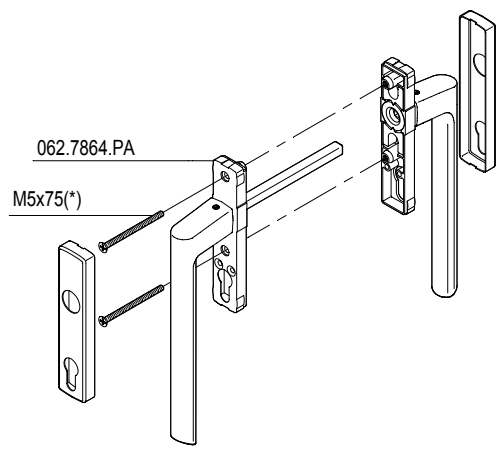

006.2344.XX
 006.2340.XX

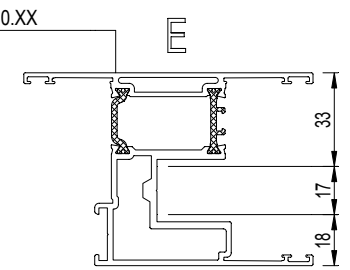

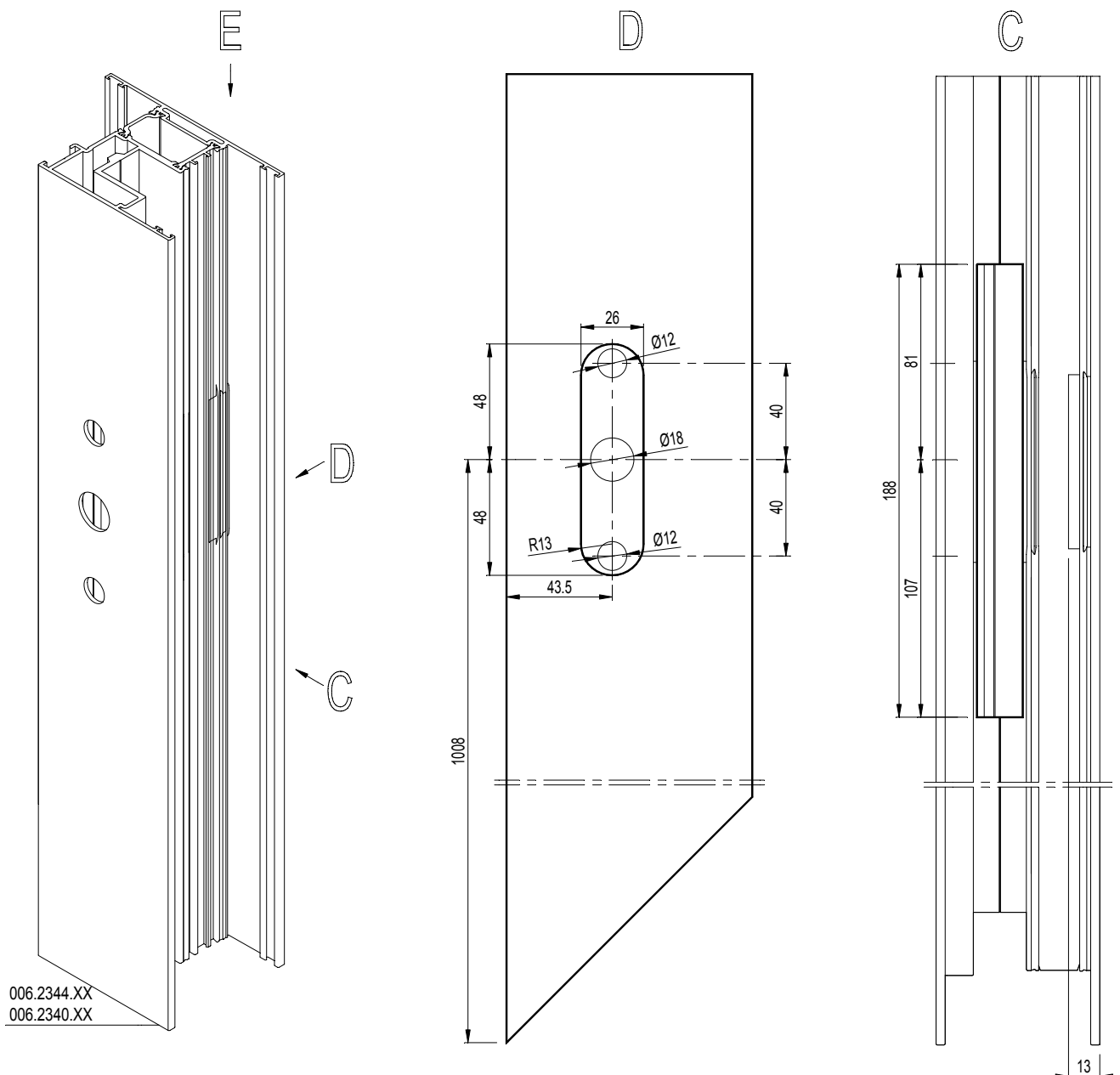

006.2344.XX
 006.2340.XX

	095.A700.00
	095.A730.00
	095.B300.00
	095.B323.00

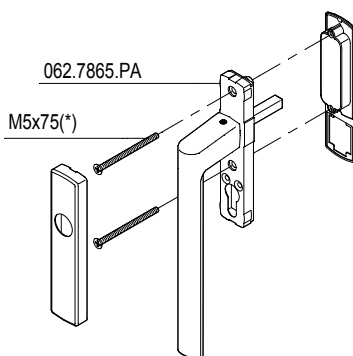

(*) SCHROEVEN M5x75 IN BASISSET
 VIS M5x75 DANS SET DE BASE
 SCREWS M5x75 IN BASIC SET
 SCHRAUBEN M5x75 IM GRUNDKARTON

062.7867.--

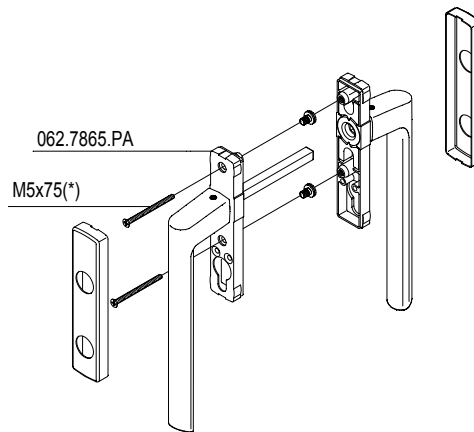
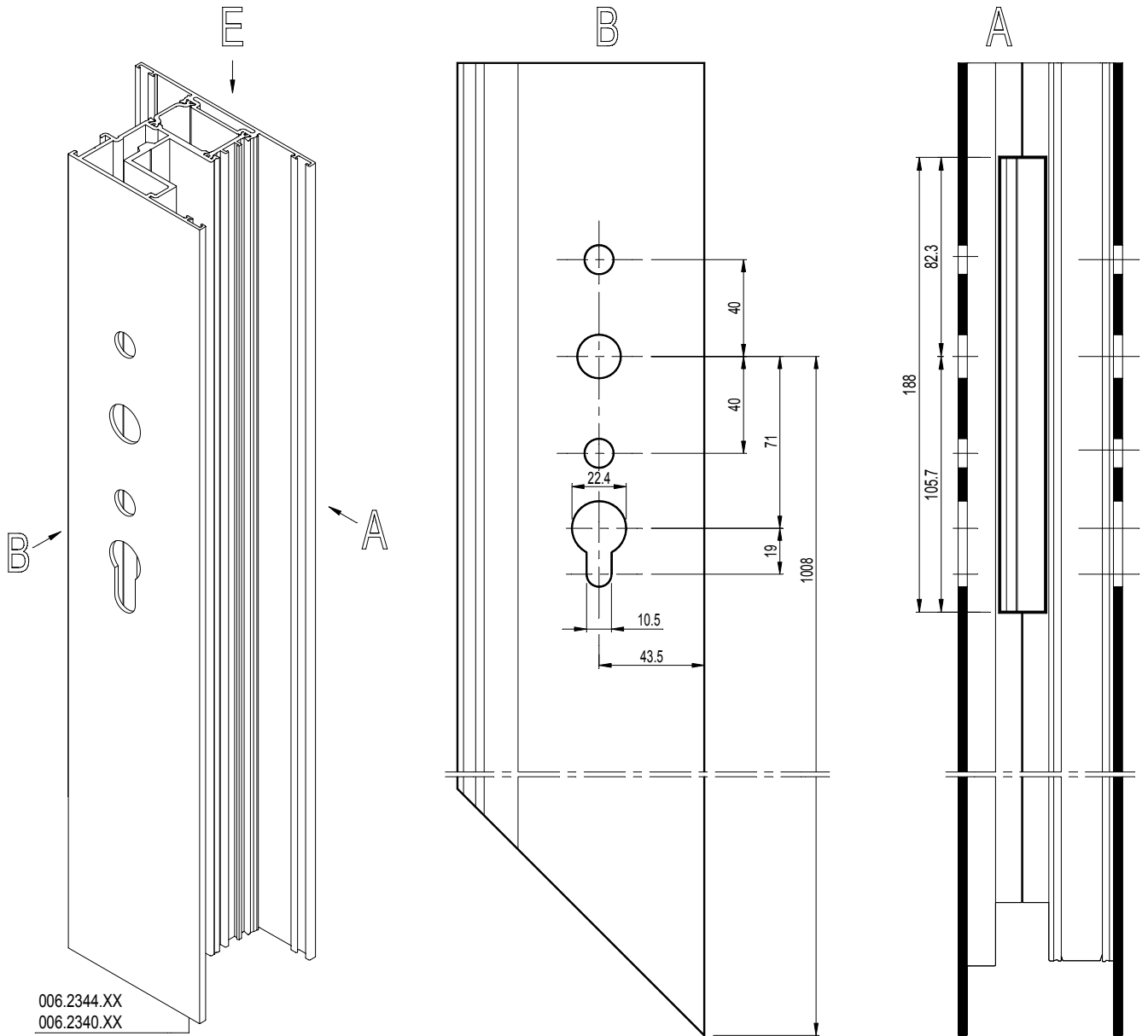



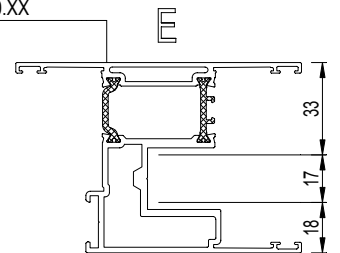







006.2344.XX
 006.2340.XX



(*) SCHROEVEN M5x75 IN BASISSET
 VIS M5x75 DANS SET DE BASE
 SCREWS M5x75 IN BASIC SET
 SCHRAUBEN M5x75 IM GRUNDKARTON

062.7867.--

D0075075

	CP 155 XQ	CP 155 XO	CP 155 XQX	CP 155 QXXQ	CP 155 OXXO	CP 155-LS XQ	CP 155-LS XQX	CP 155-LS QXXQ
062.8426.ZC 	1	2	2	1	3	---	---	---
062.7902.ZC  of - ou - oder - or 062.7868.ZC	---	---	---	---	---	1	2	2
062.8440.-- 	1	2	2	---	2	---	---	---
062.8441.-- 	---	---	---	1	1	---	---	---
062.7869.-- 	---	---	---	---	---	2	4	2
062.7871.-- 	---	---	---	---	---	---	---	1
062.8432.XX 	1	2	2	1	3	---	---	---
062.8433.XX 	1	2	2	1	3	---	---	---
062.7864.XX 	---	---	---	---	---	1	2	2
061.7038.-- 	1	2	2	1	3	1	2	2
006.0345.XX 	---	---	---	1 (H-104)	1 (H-104)	---	---	1 (H-114)

CP 155-AP CP 155-LS/AP

UITFREZING BESLAG VOOR SLOT
 FRAISAGE ACCESSOIRES POUR FERMETURE
 MILLING ACCESSORIES FOR LOCK
 AUSFRAESUNG BESCHLAG FUER SCHLOSS



BINNENZIJDE VAN VLEUGEL 006.2344.XX
 INTERIEUR D'OUVRANT 006.2344.XX
 INNENSEITE VON FLUEGEL 006.2344.XX
 INNER SIDE OF VENT 006.2344.XX

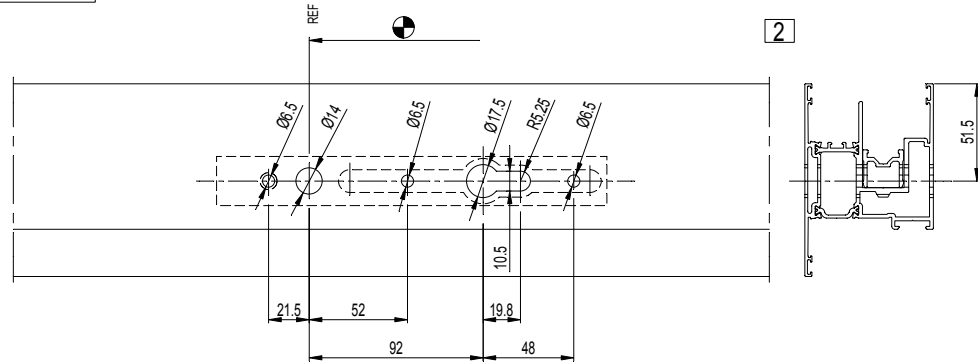

BUITENZIJDE VAN VLEUGEL 006.2344.XX
 EXTERIEUR D'OUVRANT 006.2344.XX
 AUSSENSEITE VON FLUEGEL 006.2344.XX
 OUTER SIDE OF VENT 006.2344.XX

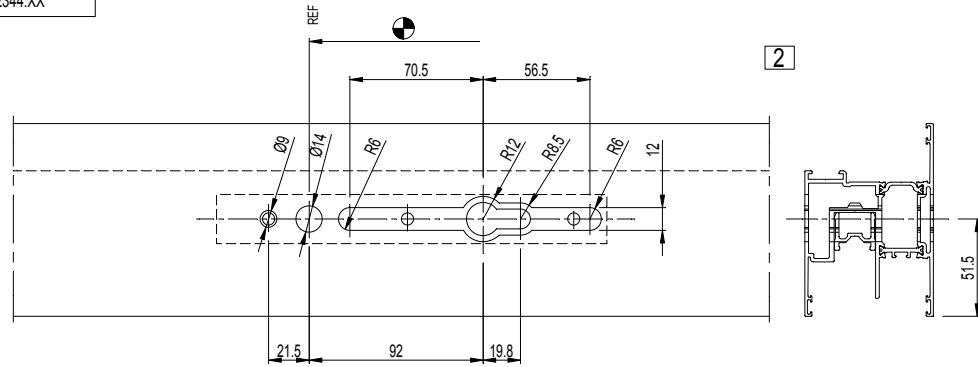

VOORKANT VAN VLEUGEL 006.2344.XX
 AVANT D'OUVRANT 006.2344.XX
 VORDERSEITE VON FLUEGEL 006.2344.XX
 FRONT OF VENT 006.2344.XX

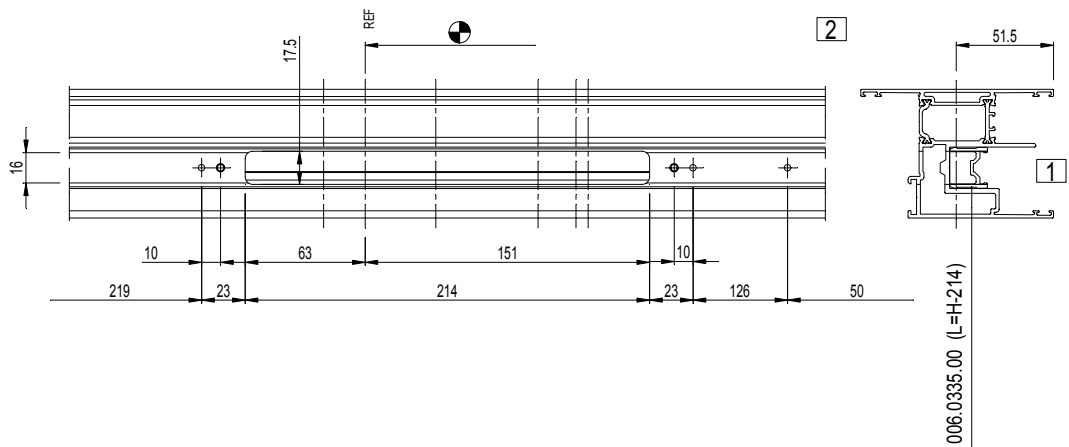

1 2 3
 MONTAGEVOLGORDE
 L'ORDRE DE MONTAGE
 MONTAGEREIHENFOLGE
 THE ORDER OF ASSEMBLY

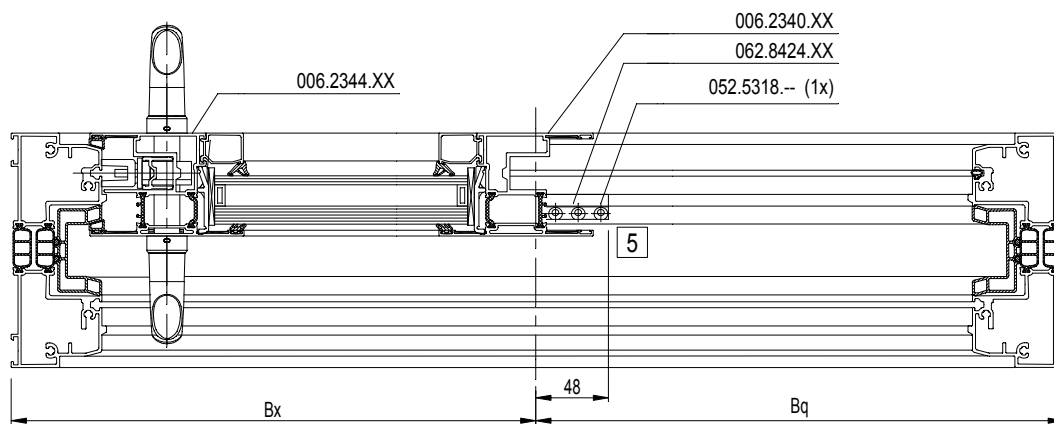
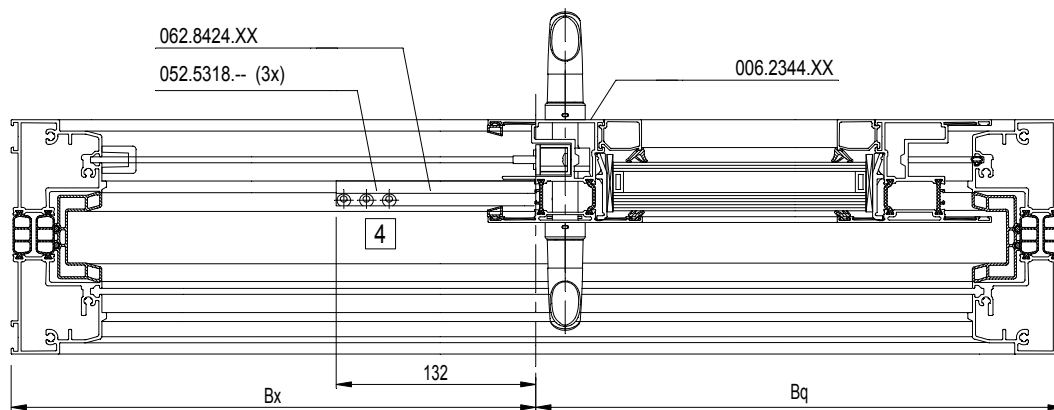
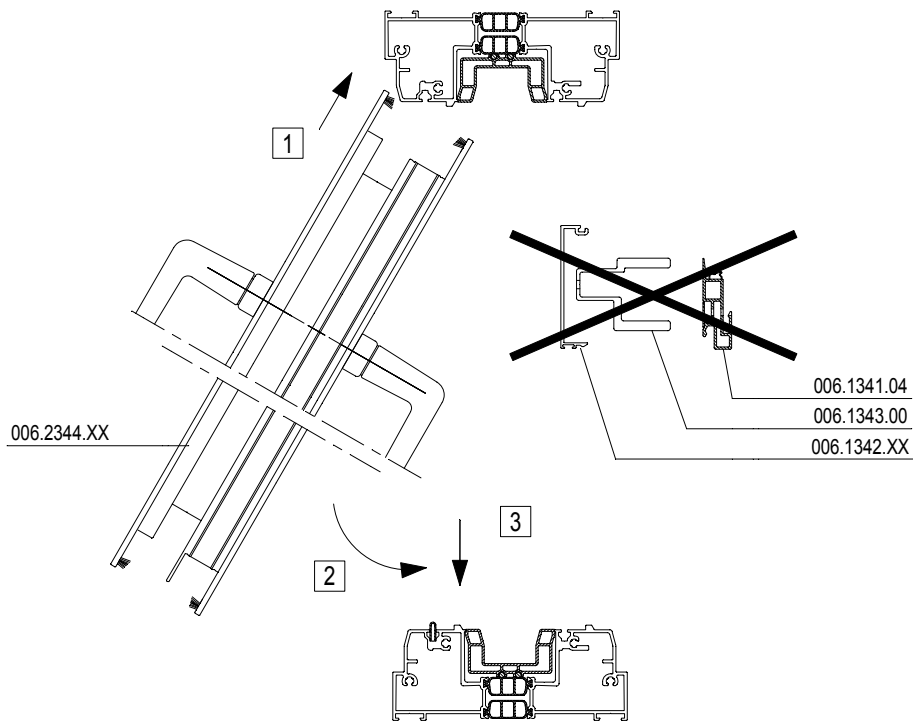

X

MONTAGEVOLGORDE
L'ORDRE DE MONTAGE
THE ORDER OF ASSEMBLY
MONTAGEREIHENFOLGE

1 2 3 .

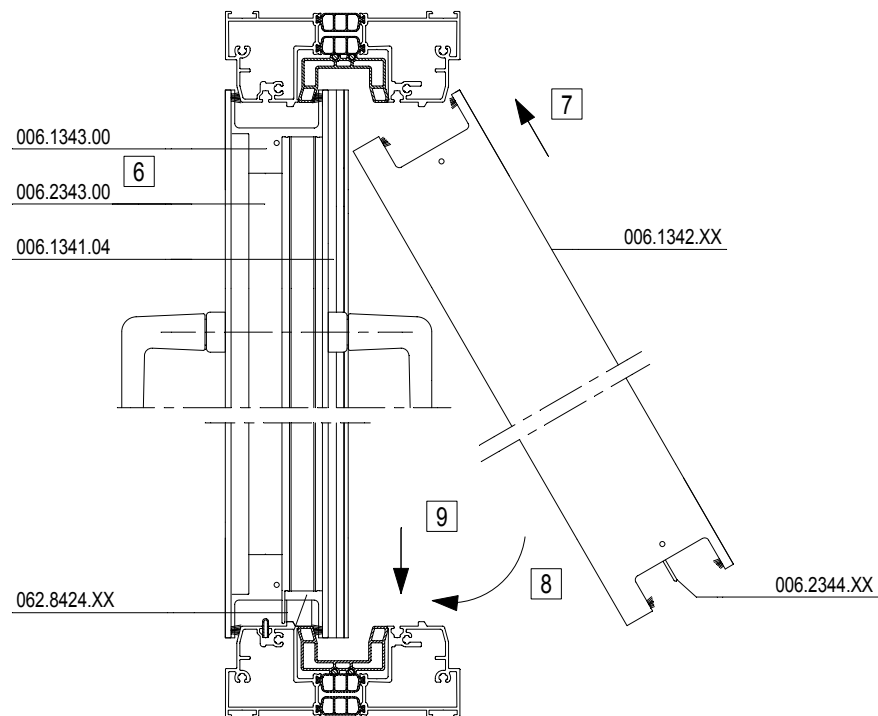

1-3: DE SCHUIVENDE VLEUGEL MONTEREN TUSSEN HET BUITENKADER OP DE BINNENRAIL. DE SCHUIVENDE VLEUGEL IS NIET VOORZIEN VAN DE HULPPROFIELEN: 006.1341.04, 006.1342.XX EN 006.1343.00.

4: DE SCHUIVENDE VLEUGEL NAAR RECHTS SCHUIVEN. DE INBRAAKBEVEILIGING 062.8424.XX BEVESTIGEN OP HET BUITENKADER MET DE SCHROEF 052.5318.-- (3x).

5: DE SCHUIVENDE VLEUGEL NAAR LINKS SCHUIVEN EN DE INBRAAKBEVEILIGING 062.8424.XX VERDER BEVESTIGEN MET DE SCHROEF 052.5318.-- (1x).

6: DE SCHUIVENDE VLEUGEL VOORZIEN VAN DE HULPPROFIELEN 006.1341.04, 006.1342.XX EN 006.1343.00.

7-9: DE VASTE VLEUGEL TUSSEN HET BUITENKADER MONTEREN.

1-3: MONTER L'OUVRANT COULISSANT ENTRE LE DORMANT SUR LE RAIL INTERIEUR. L'OUVRANT COULISSANT N'EST PAS MUNI DES PROFILES DE SUPPORT: 006.1341.04, 006.1342.XX ET 006.1343.00.

4: POUSSER L'OUVRANT COULISSANT VERS LA DROITE. FIXER LA PROTECTION ANTIVOL 062.8424.XX SUR LE DORMANT AU MOYEN DE LA VIS 052.5318.-- (3x).

5: POUSSER L'OUVRANT COULISSANT VERS LA GAUCHE ET CONTINUEUR A FIXER LA PROTECTION ANTIVOL 062.8424.XX AU MOYEN DE LA VIS 052.5318.-- (1x).

6: MUNIR L'OUVRANT COULISSANT DES PROFILES DE SUPPORT 006.1341.04, 006.1342.XX ET 006.1343.00.

7-9: MONTER L'OUVRANT FIXE ENTRE LE DORMANT.

1-3: FIT THE SLIDING PANEL BETWEEN THE OUTER FRAME ON THE INSIDE RAIL. THE SLIDING PANEL IS NOT EQUIPPED WITH THE SUPPORTING PROFILES: 006.1341.04, 006.1342.XX AND 006.1343.00.

4: PUSH THE SLIDING PANEL TO THE RIGHT. FIX THE BURGLAR PROTECTION 062.8424.XX ON THE OUTER FRAME BY MEANS OF SCREW 052.5318.-- (3x).

5: PUSH THE SLIDING PANEL TO THE LEFT AND CONTINUE TO FIX THE BURGLAR PROTECTION 062.8424.XX BY MEANS OF SCREW 052.5318.-- (1x).

6: EQUIP THE SLIDING PANEL WITH THE SUPPORTING PROFILES 006.1341.04, 006.1342.XX AND 006.1343.00.

7-9: FIT THE FIXED PANEL BETWEEN THE OUTER FRAME.

1-3: DEN SCHIEBEFLÜGEL ZWISCHEN DEN BLENDRAHMEN AUF DIE INNENSCHIENE MONTIEREN. DER SCHIEBEFLÜGEL IST NICHT MIT ZUSATZPROFILIEN AUSGESTATTET: 006.1341.04, 006.1342.XX UND 006.1343.00 AUSGESTATTET.

4: DEN SCHIEBEFLÜGEL NACH RECHTS SCHIEBEN. DIE EINBRUCHSSICHERUNG 062.8424.XX AM BLENDRAHMEN BEFESTIGEN MIT DER SCHRAUBE 052.5318.-- (3x).

5: DEN SCHIEBEFLÜGEL NACH LINKS SCHIEBEN UND DIE EINBRUCHSSICHERUNG 062.8424.XX WEITER MIT DER SCHRAUBE 052.5318.-- (1x) BEFESTIGEN.

6: DEN SCHIEBEFLÜGEL MIT DEN ZUSATZPROFILIEN 006.1341.04, 006.1342.XX UND 006.1343.00 AUSSTATTEN.

7-9: DEN FESTEN FLÜGEL ZWISCHEN DEN BLENDRAHMEN MONTIEREN.

MONORAIL

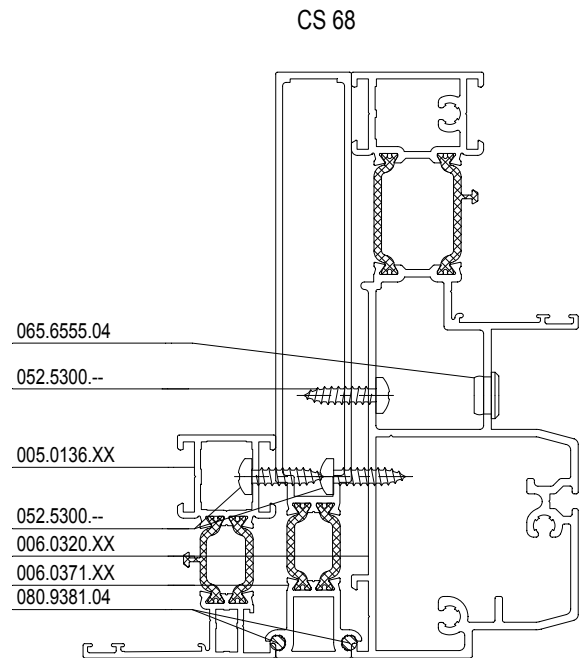
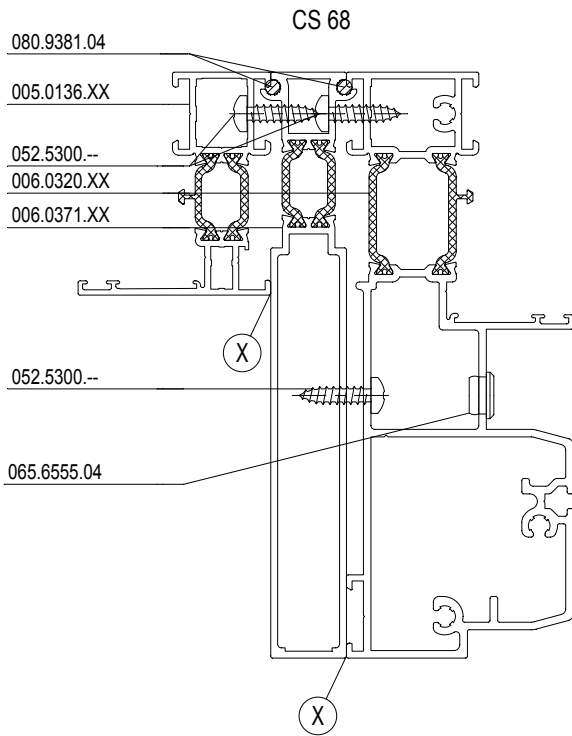

2-RAIL

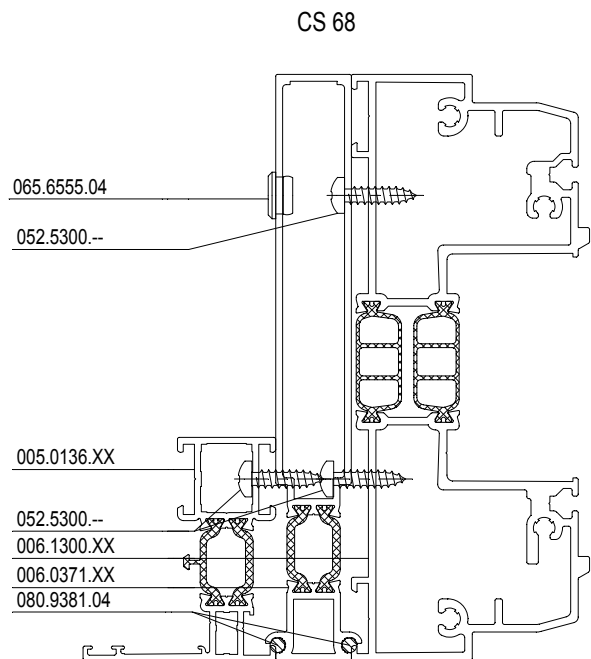
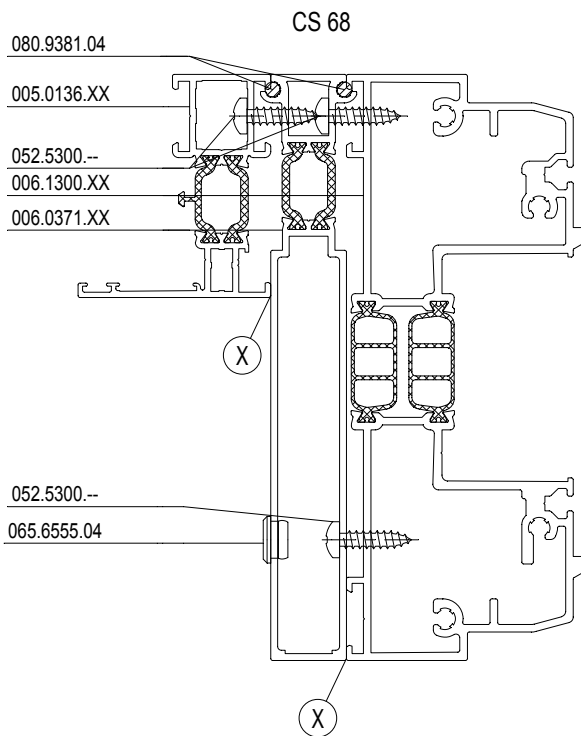

(X) DICHTINGSMIDDEL
MATIERE D'ETANCHEITE
SEALING AGENT
ABDICHTUNG

D0013971

MONORAIL

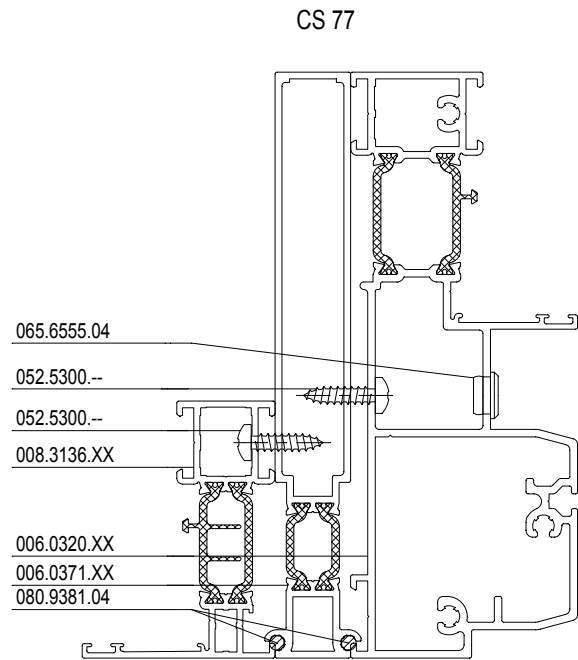
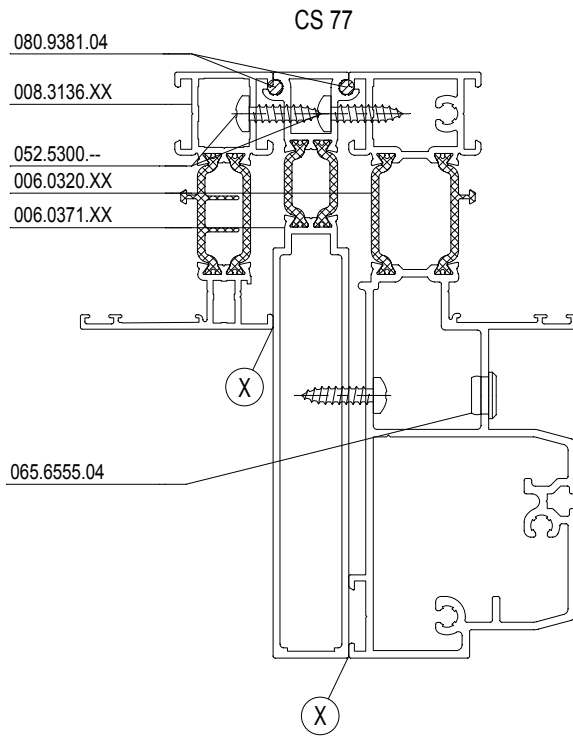

2-RAIL

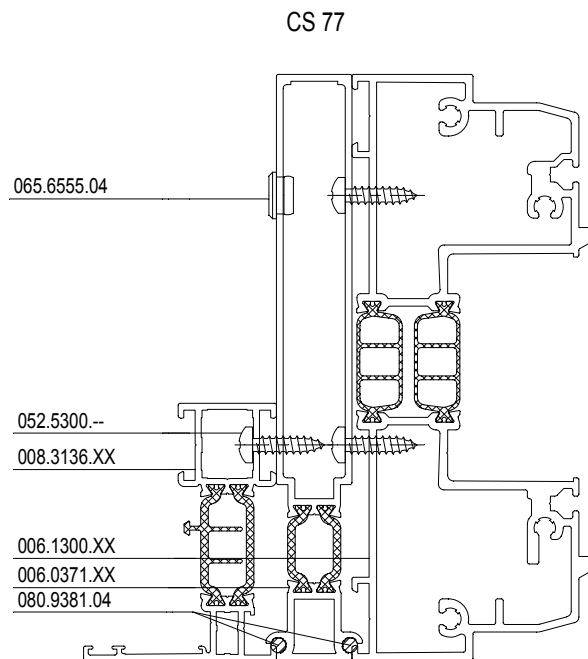
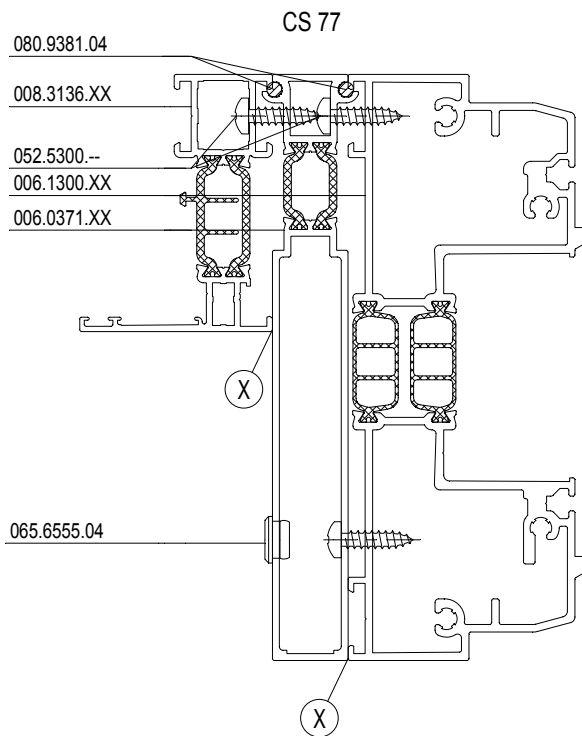

MONORAIL

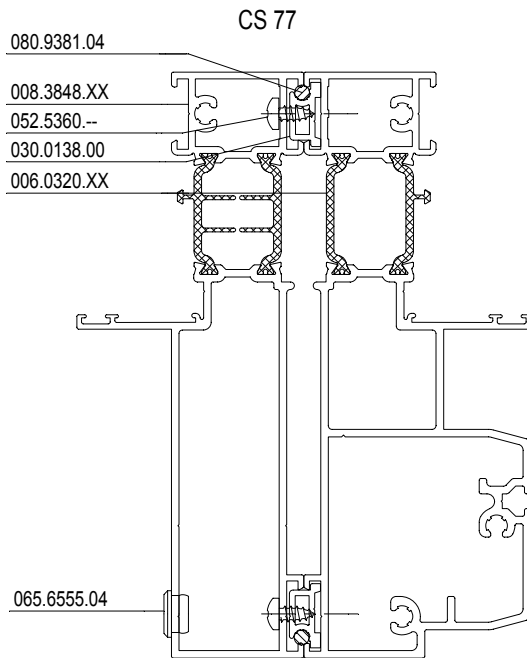

2-RAIL

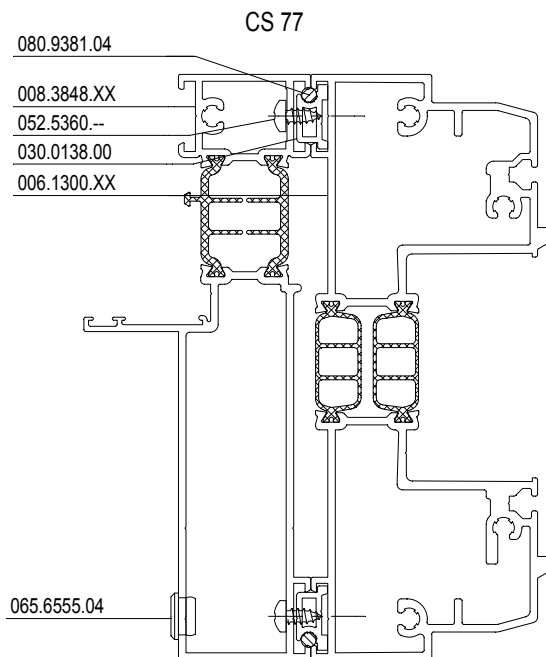

(X)	DICHTINGSMIDDEL MATIERE D'ETANCHEITE SEALING AGENT ABDICHTUNG
-----	--

D0079442

MONORAIL

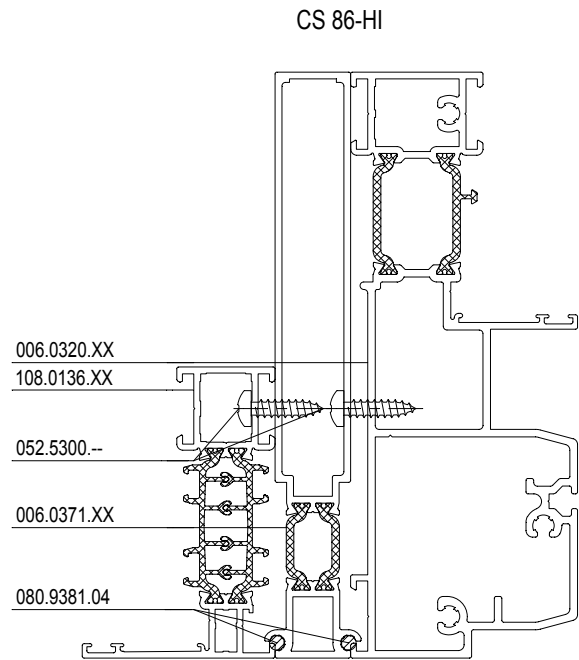
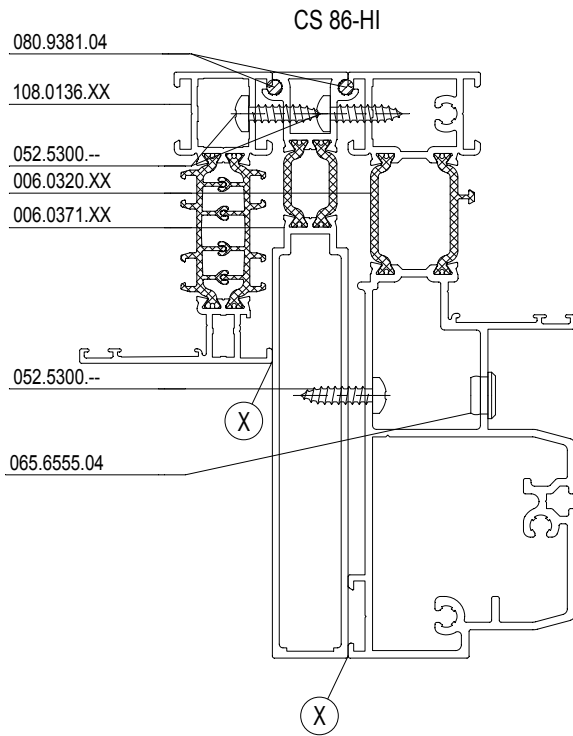

2-RAIL

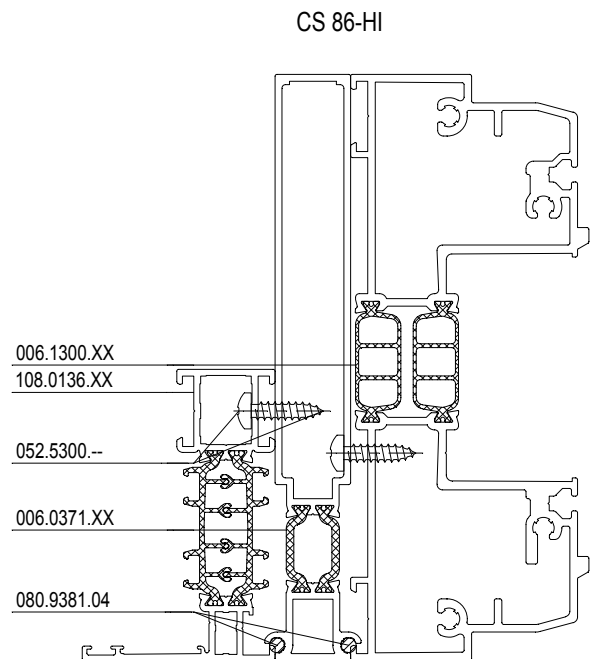
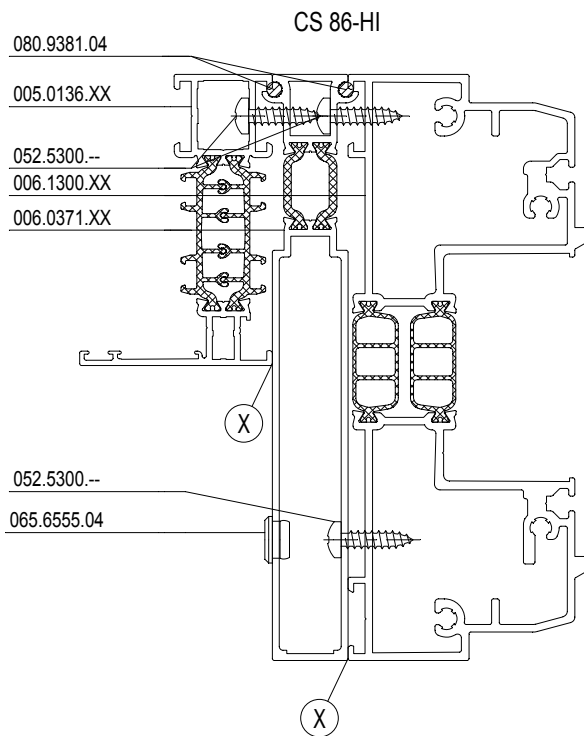

CP 155 CP 155-LS

BUFFER
BUTEE
BUFFER
STOPPER



(A)	VLEUGELGEWICHT POIDS DU VANTAIL WEIGHT OF THE VENT FLÜGELGEWICHT	MAX. 300KG
-----	---	------------

PLAATS VAN DE BUFFER TE BEPALEN MET OPEN VLEUGEL
PLACE DE LA BUTEE A DETERMINER AVEC OUVRANT OUVERT
PLACE OF BUFFER TO DETERMINE WITH OPEN VENT
STELLE DES STOPPERS ZU BESTIMMEN MIT GEÖFFNETEM FLÜGEL

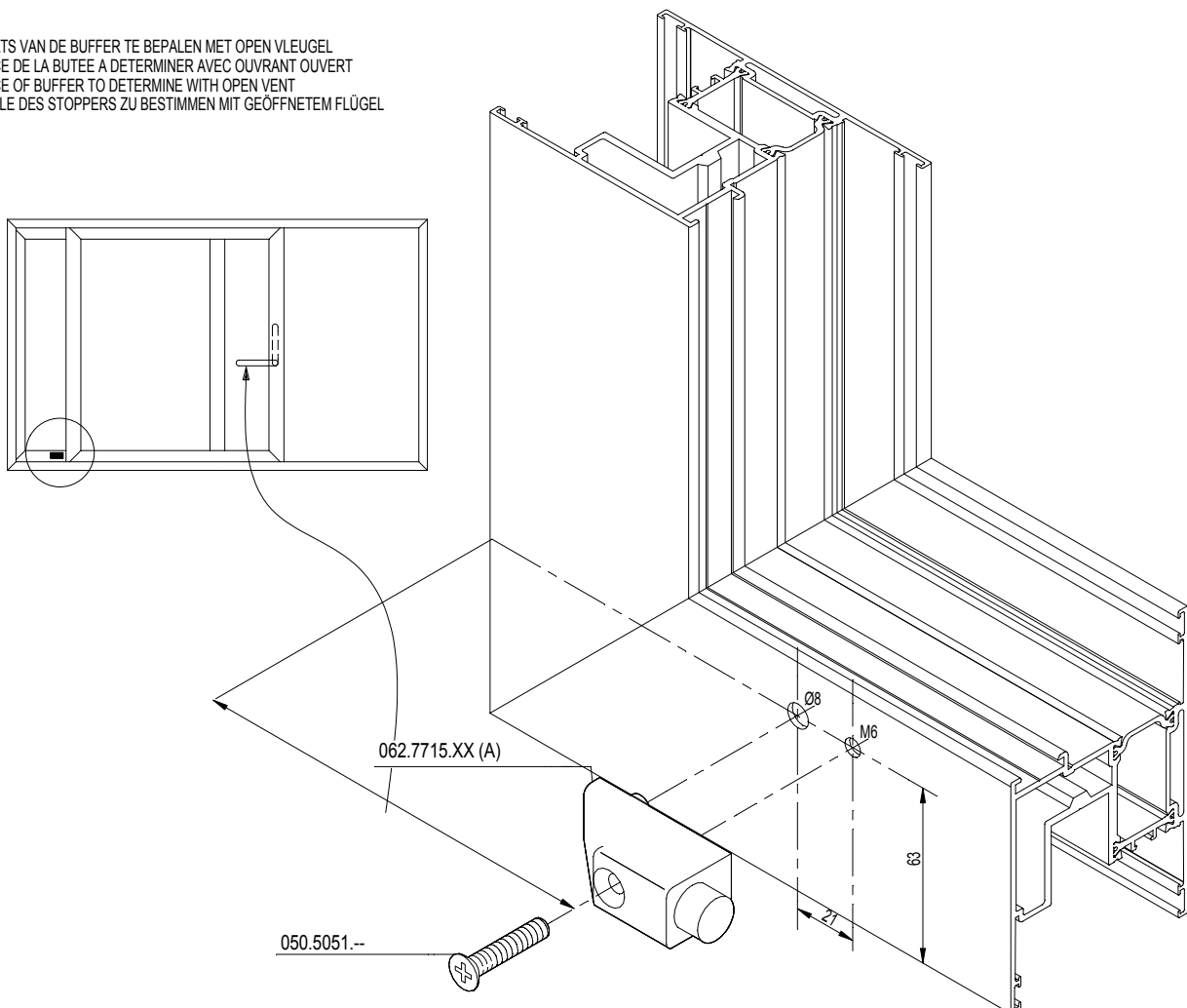

CP 155 CP 155-LS

BUFFER
BUTEE
BUFFER
STOPPER



(B)	VLEUGELGEWICHT	MIN. 300KG MAX. 400KG
	POIDS DU VANTAIL	
	WEIGHT OF THE VENT	
	FLÜGELGEWICHT	

PLAATS VAN DE BUFFER TE BEPALEN MET OPEN VLEUGEL
PLACE DE LA BUTEE A DETERMINER AVEC OUVRANT OUVERT
PLACE OF BUFFER TO DETERMINE WITH OPEN VENT
STELLE DES STOPPERS ZU BESTIMMEN MIT GEÖFFNETEM FLÜGEL

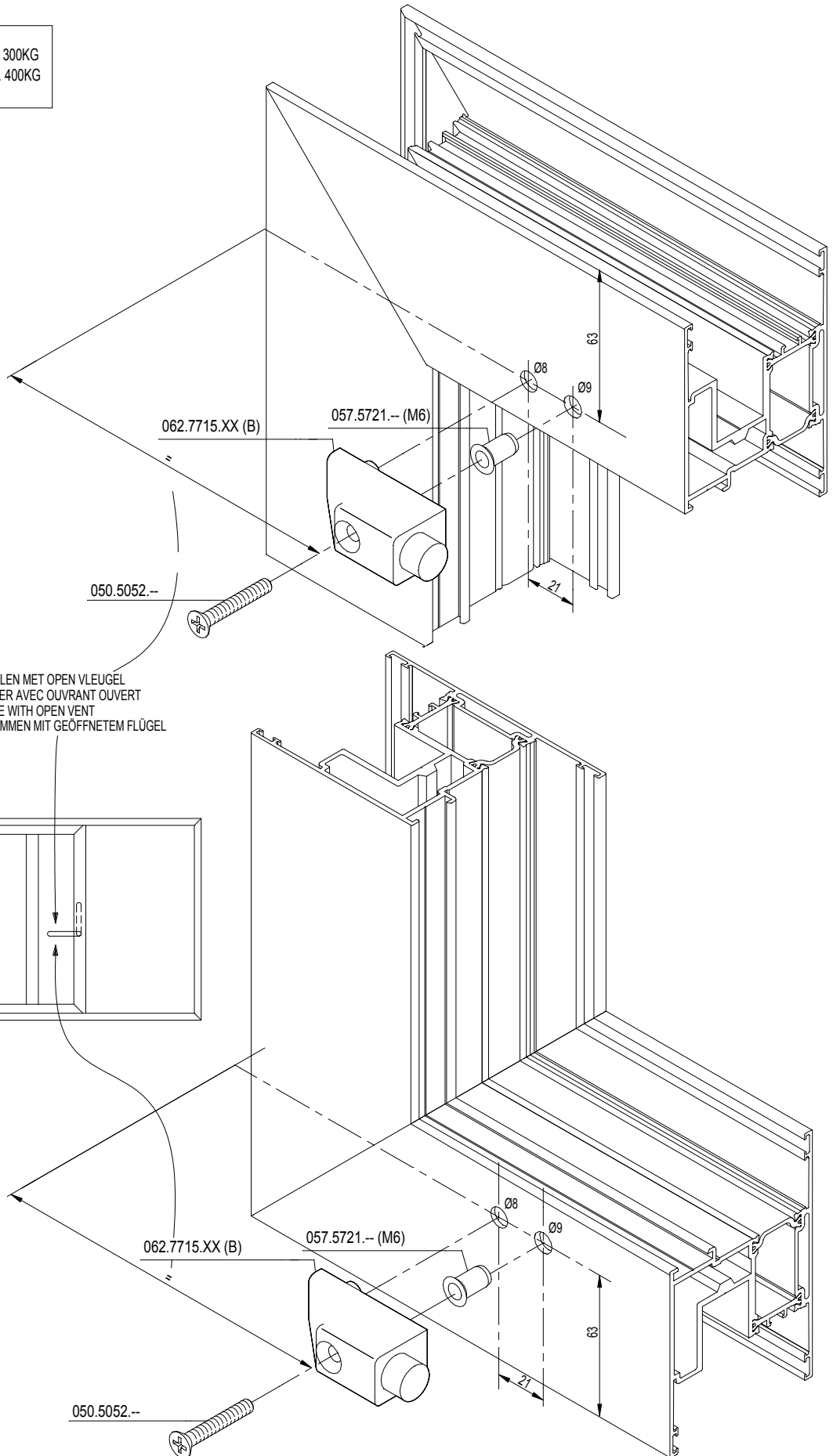
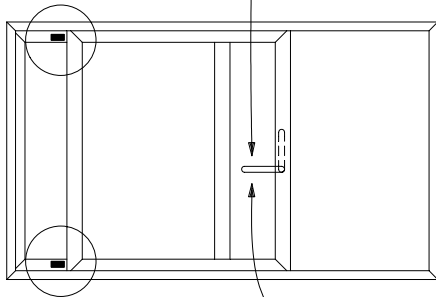

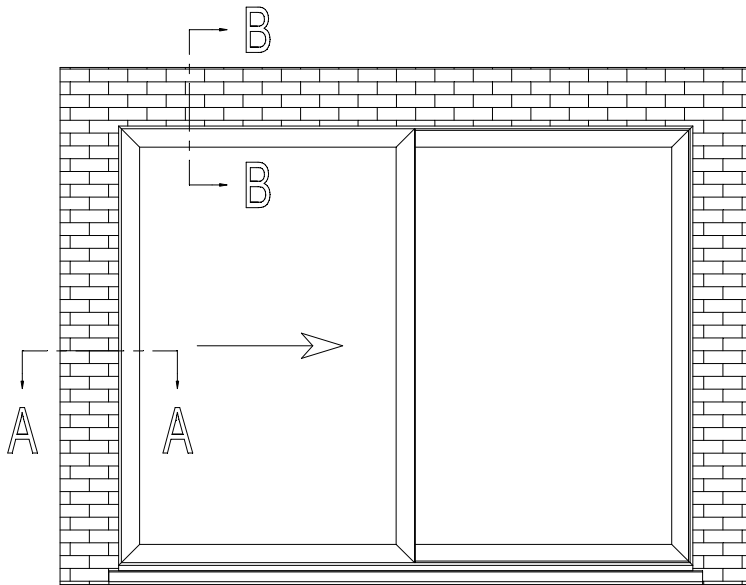

MONTAGEVOLGORDE
L'ORDRE DE MONTAGE
THE ORDER OF ASSEMBLY
MONTAGEREIHENFOLGE

1	2	3	.
---	---	---	---

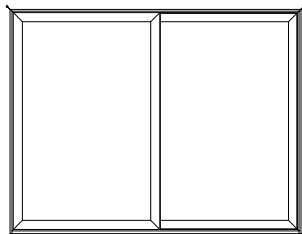

VARIANT(E) 084.9426.07

A - A

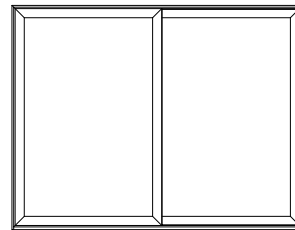

VARIANT(E) 084.9414.07 / 084.9420.07

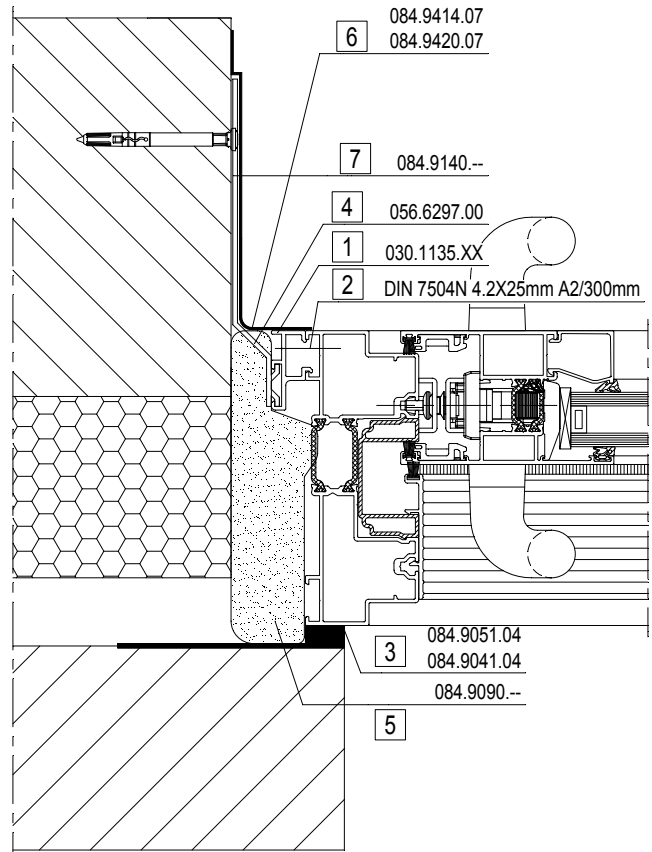
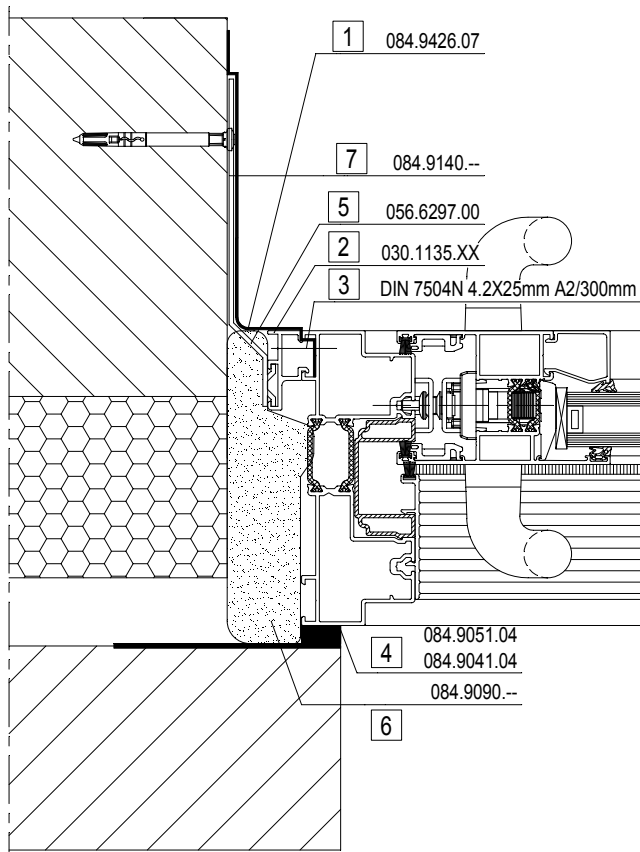

B - B

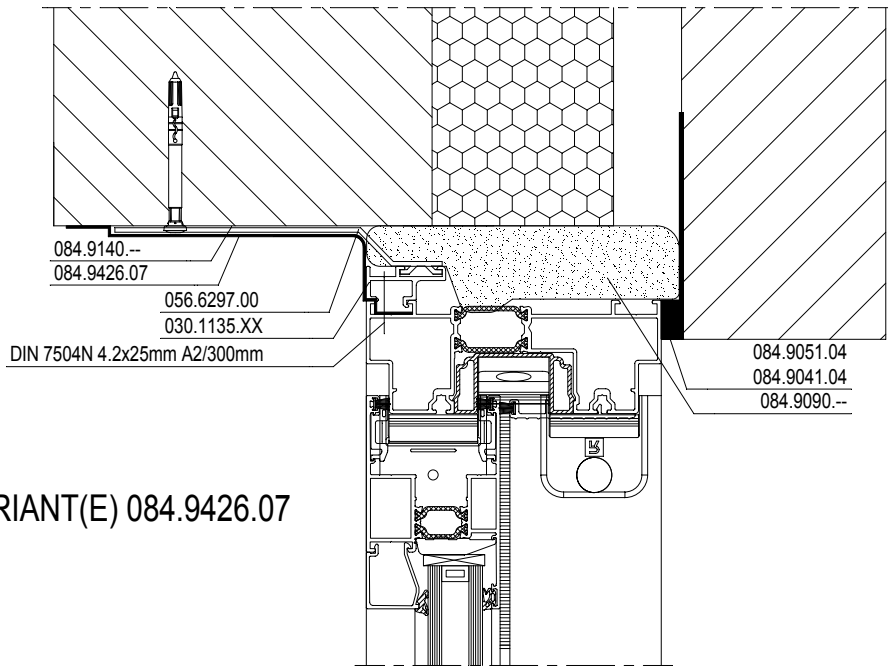

VARIANT(E) 084.9426.07

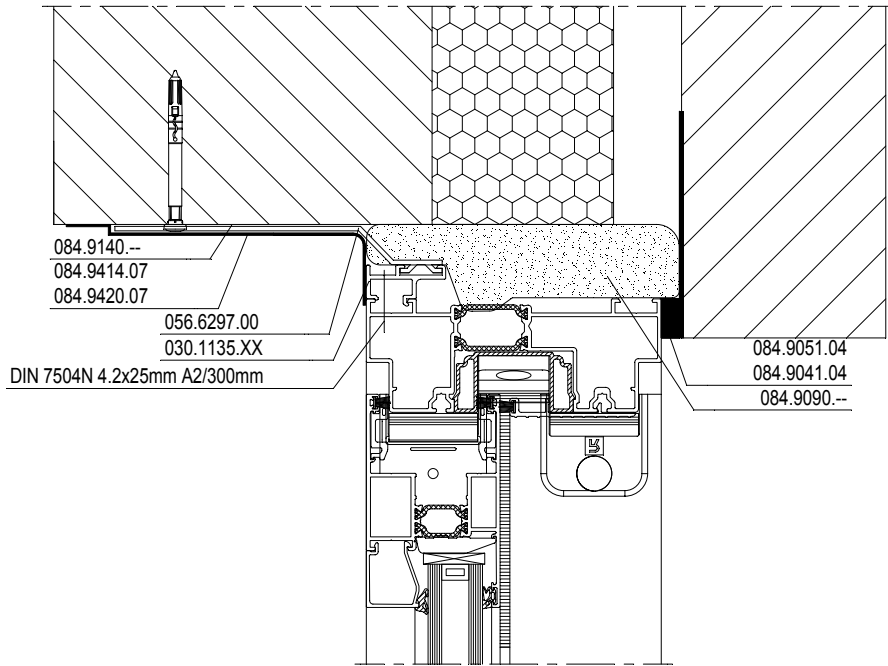

VARIANT(E) 084.9414.07 / 084.9420.07

MONTAGEVOLGORDE
L'ORDRE DE MONTAGE
THE ORDER OF ASSEMBLY
MONTAGEREIHENFOLGE

1 2 3 .



1

ONTVETTEN
DEGRAISSAGE
DEGREASING
ENTFETTEN



1

KLEVEN 084.9426.04
ADHERANCE 084.9426.04
STICKING 084.9426.04
KLEBEN 084.9426.04



1

LUSSEN IN DE HOEKEN
BOUCLES DANS LES COINS
LOOPS IN THE CORNERS
SCHLINGEN IN DEN ECKEN



1

AANROLLEN
PRESSION
PRESSING
ANDRÜCKEN



095.1000.--



2



3

MONTEREN PROFIEL 030.1135.XX
MONTAGE PROFILE 030.1135.XX
FIXING PROFILE 030.1135.XX
MONTIEREN PROFIL 030.1135.XX

4



AANBRENGEN ZWELBAND 084.9041.07 / 084.9051.04
MONTAGE BANDE GONFLANT 084.9041.07 / 084.9051.04
FIXING SWELLING TAPE 084.9041.07 / 084.9051.04
MONTIEREN SCHWELLBAND 084.9041.07 / 084.9051.04

5



VERANKERING
ANCRAGE
ANCHORING
VERANKERUNG

6



AANBRENGEN PUR 084.9090.--
APPLICATION PUR 084.9090.--
APPLICATION PUR 084.9090.--
AUFTRAGEN PUR 084.9090.--



095.J200.00

7



AANBRENGEN HECHTPASTA 084.9140.--
APPLICATION PATE ADHESIVE 084.9140.--
APPLICATION ADHESIVE PASTE 084.9140.--
AUFTRAGEN HAFTPASTA 084.9140.--

7



VERKLEVEN FOLIE OP RUWBOUW
ADHERENCE FILM SUR L'EBAUICHE
STICKING FILM ON TE ROUGH STRUCTURE
HAFTEN FOLIE AUF DEN ROHBAU

MONTAGEVOLGORDE
L'ORDRE DE MONTAGE
THE ORDER OF ASSEMBLY
MONTAGEREIHENFOLGE

1 2 3 .



1

2

AANBRENGEN PROFIEL
MONTAGE PROFILE
FIXING PROFILE
MONTIEREN PROFIL



1

2

OM DE 30 CM
CHAQUE 30 CM
EACH 30 CM
JEDER 30 CM



3

AANBRENGEN ZWELBAND
MONTAGE BANDE GONFLANT
FIXING SWELLING TAPE
MONTIEREN SCHWELLBAND



4

VERANKEREN
ANCRAGE
ANCHORING
VERANKERUNG



5

AANBRENGEN PUR 084.9090.--
APPLICATION PUR 084.9090.--
APPLICATION PUR 084.9090.--
AUFTRAGEN PUR 084.9090.--



095.J200.00

6



ONTVETTEN
DEGRAISSAGE
DEGREASING
ENTFETTEN

6



AANBRENGEN FOLIE OP HET RAAM EN AANROLLEN
MONTAGE FILM SUR LA FENETRE ET PRESSION
FIXING FILM ON THE WINDOW AND PRESSING
MONTIEREN FOLIE AUF DAS FENSTER UND ANDRUCKEN



095.1000.--

7

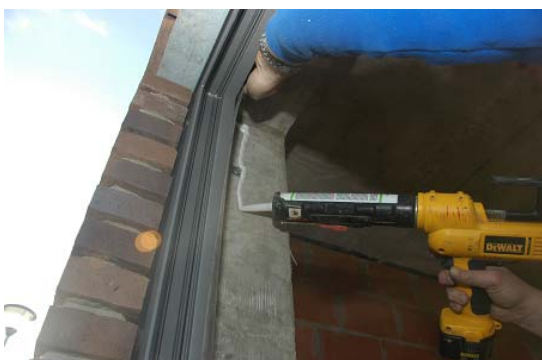

AANBRENGEN HECHTPASTA 084.9140.--
APPLICATION PATE ADHESIVE 084.9140.--
APPLICATION ADHESIVE PASTE 084.9140.--
AUFTRAGEN HAFTPASTA 084.9140.--

7



AANBRENGEN FOLIE
MONTAGE FILM
FIXING FILM
MONTIEREN FOLIE

7



AANROLLEN
PRESSION
PRESSING
ANDRUCKEN



095.1500.--

7



OVERLAPPEN IN DE HOEKEN
CHEVAUCHEMENT DANS LES COINS
OVERLAPPING IN THE CORNERS
UBERLAPPING IN DEN ECKEN

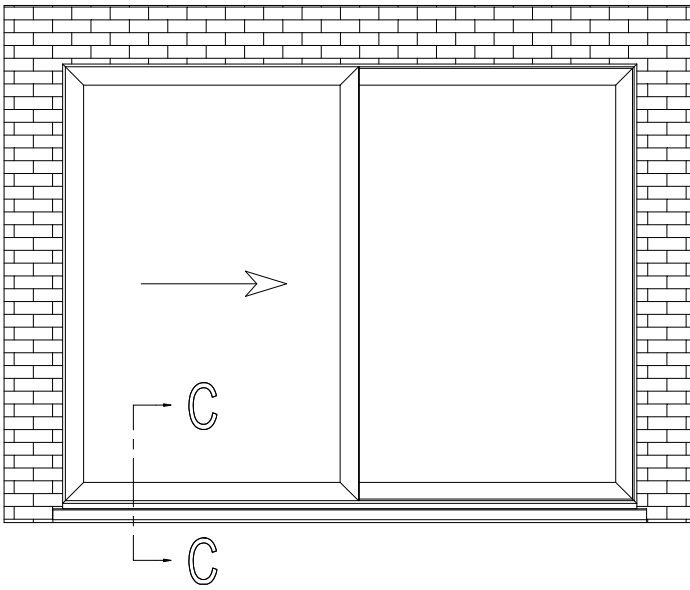

C - C

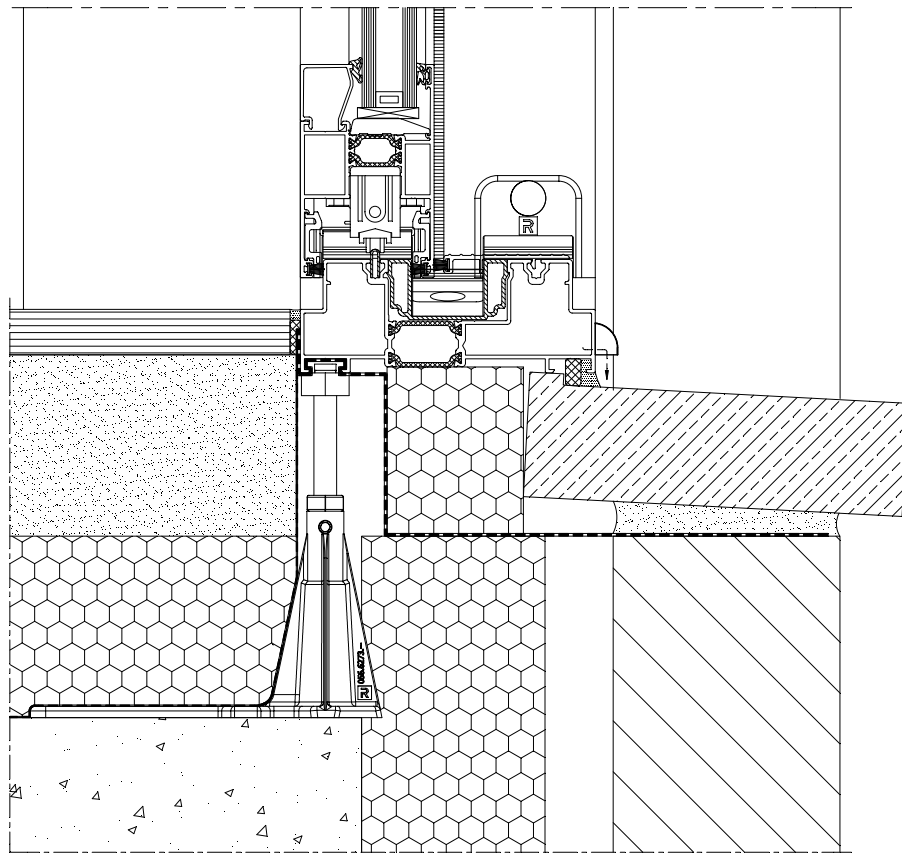

CP 155 CP 155-LS

KOPPELSTUK
PIECE DE RACCORDEMENT
CONNECTION PIECE
KUPPLUNGSSTUECK

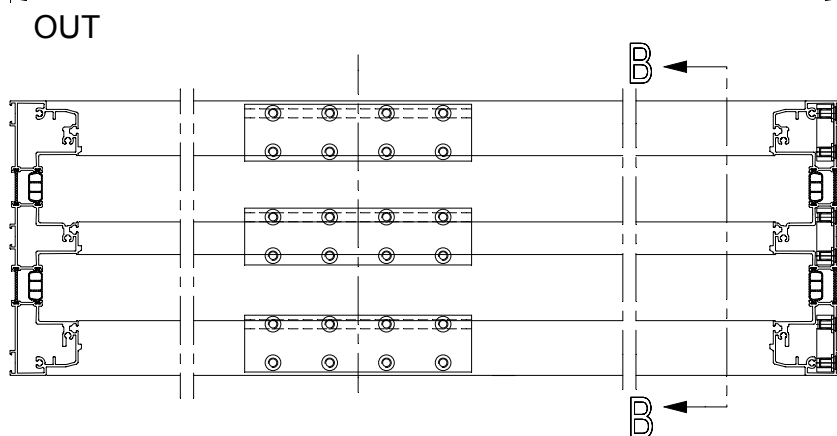
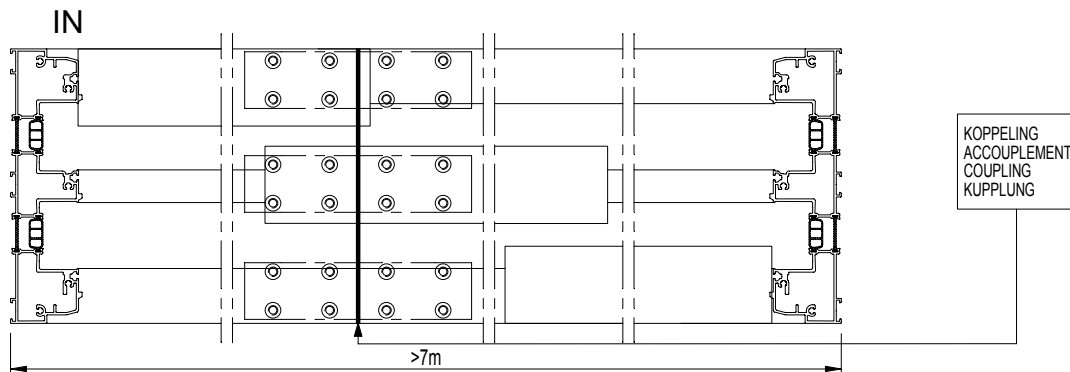
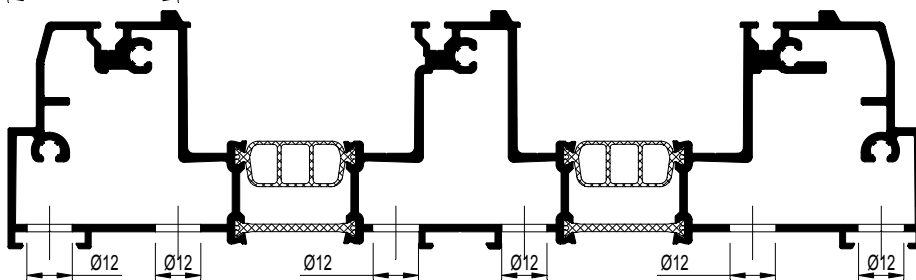
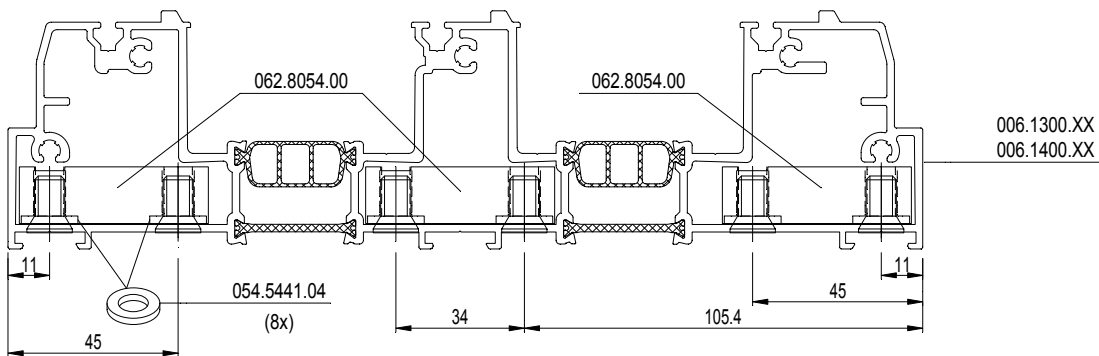
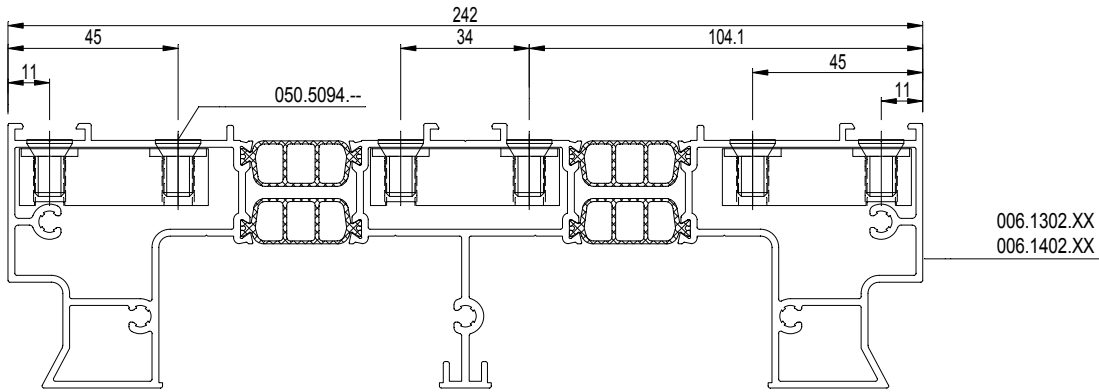

MONTAGEVOLGORDE
L'ORDRE DE MONTAGE
THE ORDER OF ASSEMBLY
MONTAGEREIHENFOLGE

1	2	3	.
---	---	---	---

DICHTINGSMIDDEL
MATIERE D'ETANCHEITE
SEALING AGENT
ABDICHTUNG

084.9063.XX

D0074908

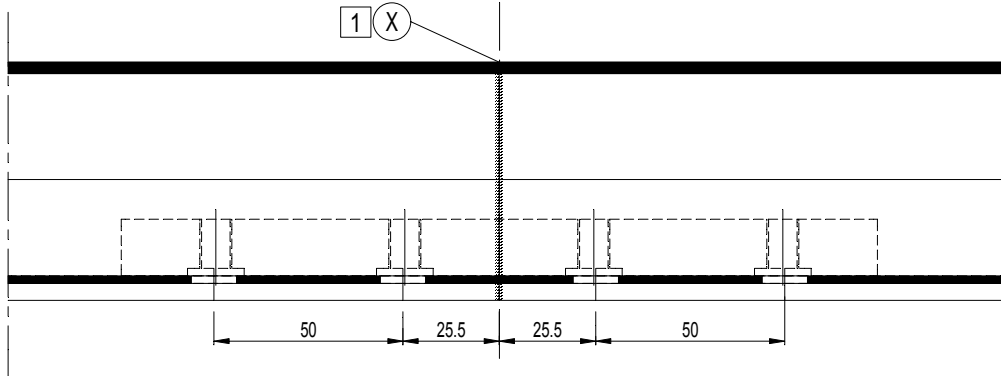
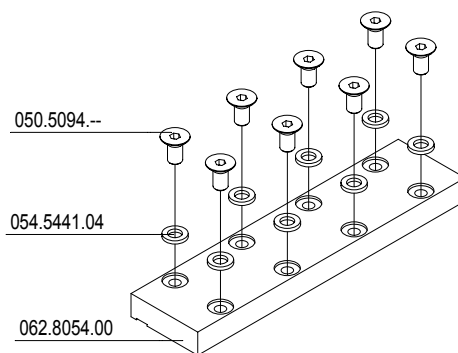
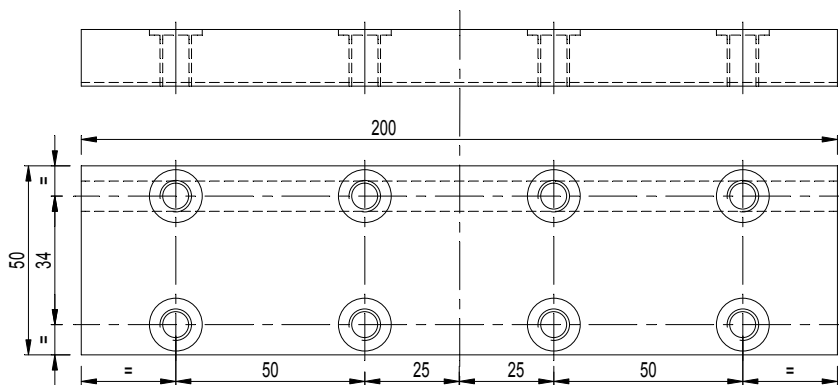
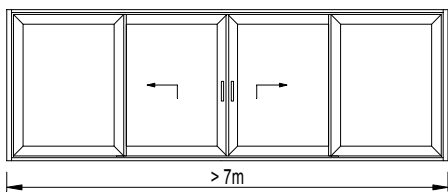

PRINCIPETEKENING
DESSIN DE PRINCIPE
SCHEMATIC DRAWING
GRUNDSATZZEICHNUNG

B - B

062.8054.00

<p>BIJ KOPPELING, GEBRUIK WATERDICHTE FOLIE EN CAS DE RACCORDEMENT, EMPLOYEZ DU FEUIL ETANCHE WHEN CONNECTING, PLEASE APPLY WATERTIGHT FOIL BEI KOPPELUNG, WENDEN SIE EINE WASSERDICHT FOLIE AN</p>	<p>ZIE ARCHITECTENKATALOG VOIR ARCHITECTE CATALOGUE SEE ARCHITECT CATALOGUE SEHEN ARCHITEKT KATALOG</p>
---	---

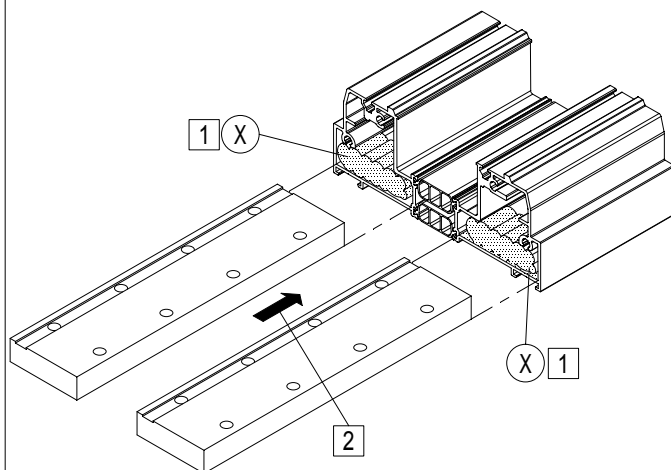

!

1

AFDICHTEN OP DE ZAAGSNEDEN EN IN DE PROFIELKAMER
ETACHEMENT DES COUPES ET DANS LA CHAMBRE DU PROFILE
SEALING ON THE SAW CUTS AND IN THE PROFILE CHAMBER
DIE SCHNITTFLACHEN UND IN DEN PROFILKAMMERN, MIT EINER NEUTRALEN,
ELASTISCHEN DICHTUNGSMASSE VERSEHEN

CP 155 CP 155-LS

GLASSTEUNEN
SUPPORTS CALE DE VITRAGE
GLASS SUPPORTS
KLOTZBRUECKEN

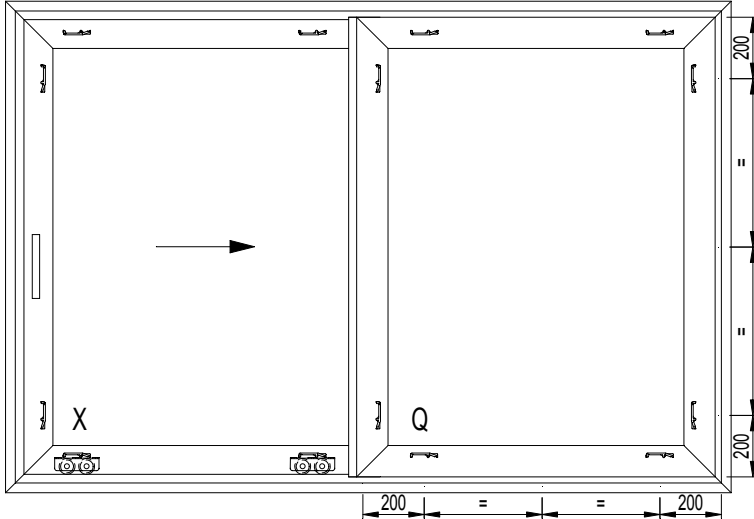
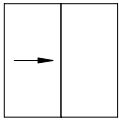

Glassteun:(0-250kg/vleugel) 8x069.8704.01
Supports de cale de vitrage:(0-250kg/ouvrant) 8x069.8704.01
Glasauflageprofil:(0-250kg/Fluegel) 8x069.8704.01
Glass support:(0-250kg/vent) 8x069.8704.01

Loopwagen:
Roulettes: 0-250kg: 2x062.7834.-- + 4x052.5372.--
Rollers:
Laufwagen:

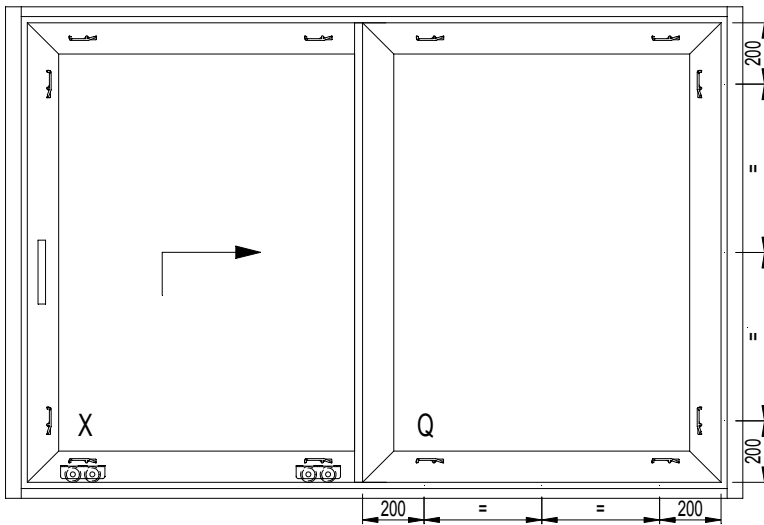
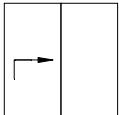

Glassteun:(0-250kg/vleugel) 8x069.8704.01
(250-400kg/vleugel) 6x069.8704.01 + 2x069.8724.04
Supports de cale de vitrage:(0-250kg/ouvrant) 8x069.8704.01
(250-400kg/ouvrant) 6x069.8704.01 + 2x069.8724.04
Glass support:(0-250kg/vent) 8x069.8704.01
(250-400kg/vent) 6x069.8704.01 + 2x069.8724.04
Glasauflageprofil:(0-250kg/Fluegel) 8x069.8704.01
(250-400kg/Fluegel) 6x069.8704.01 + 2x069.8724.04

Loopwagen:
Roulettes: 0-300kg:1x062.7867.--
Rollers: 300-400kg:1x062.7867.-- + 1x062.7903.--
Laufwagen:

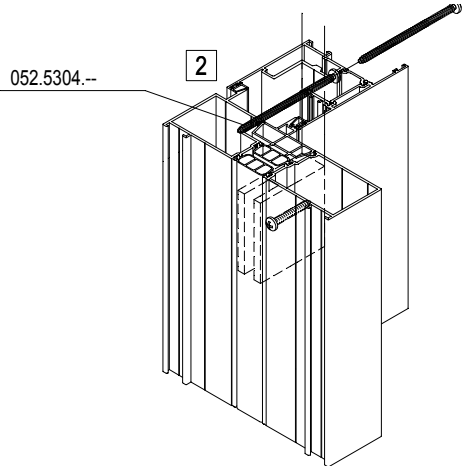
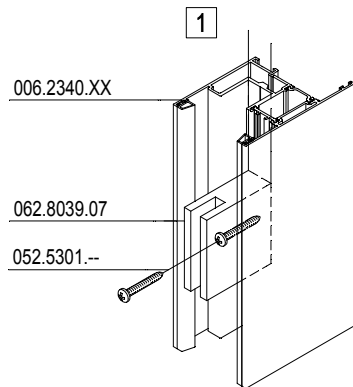
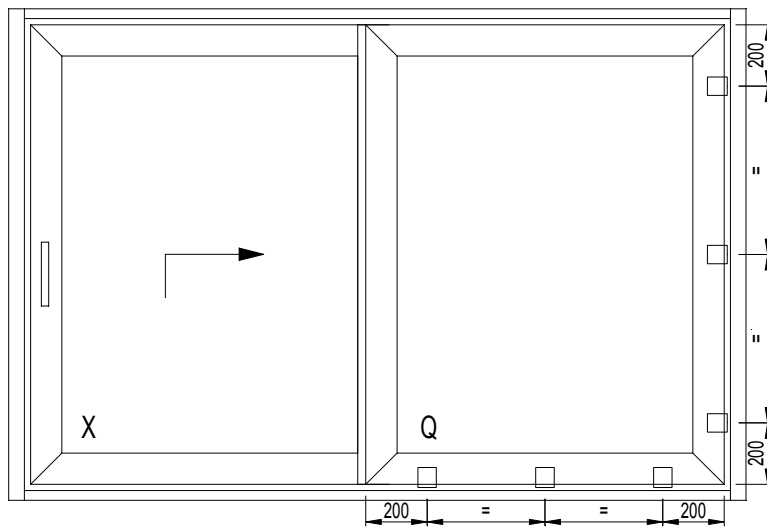
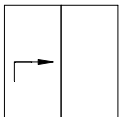
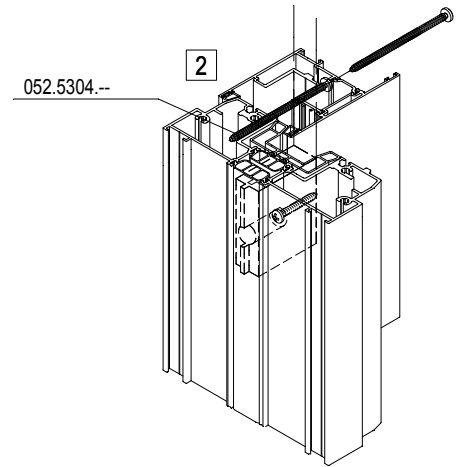
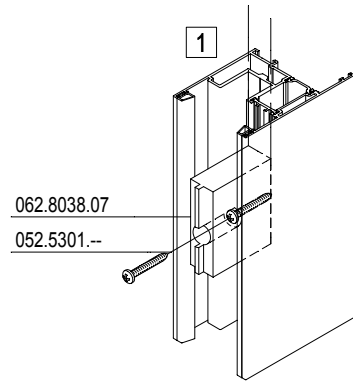
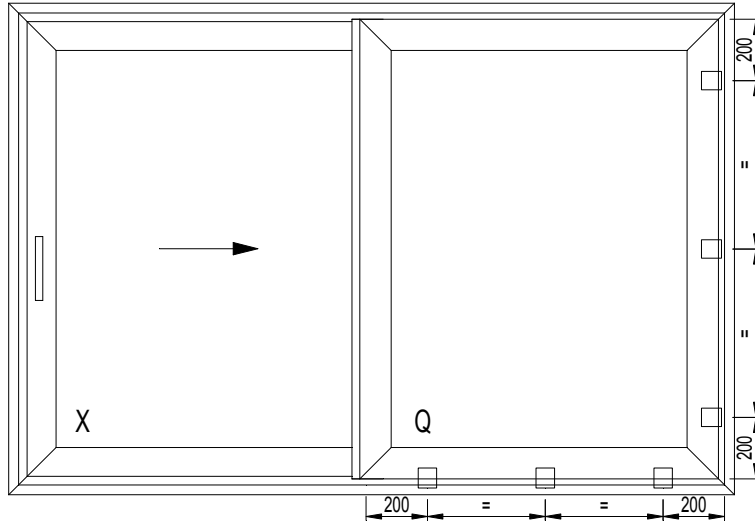
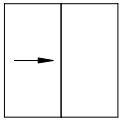

MONTAGEVOLGORDE L'ORDRE DE MONTAGE THE ORDER OF ASSEMBLY MONTAGEREIHENFOLGE	1	2	3	.
--	---	---	---	---

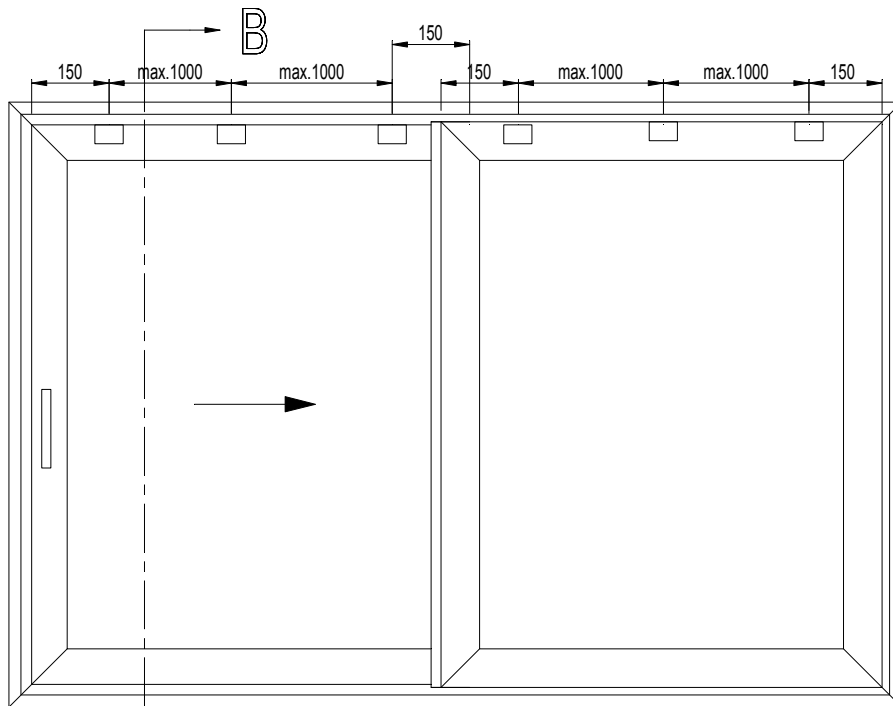
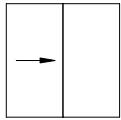

B

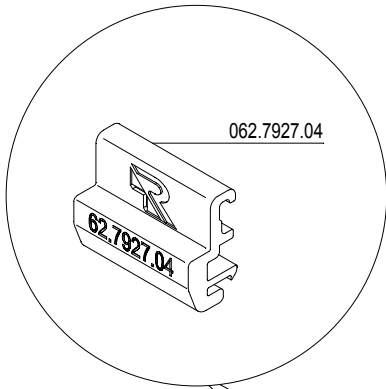

062.7927.04

B - B

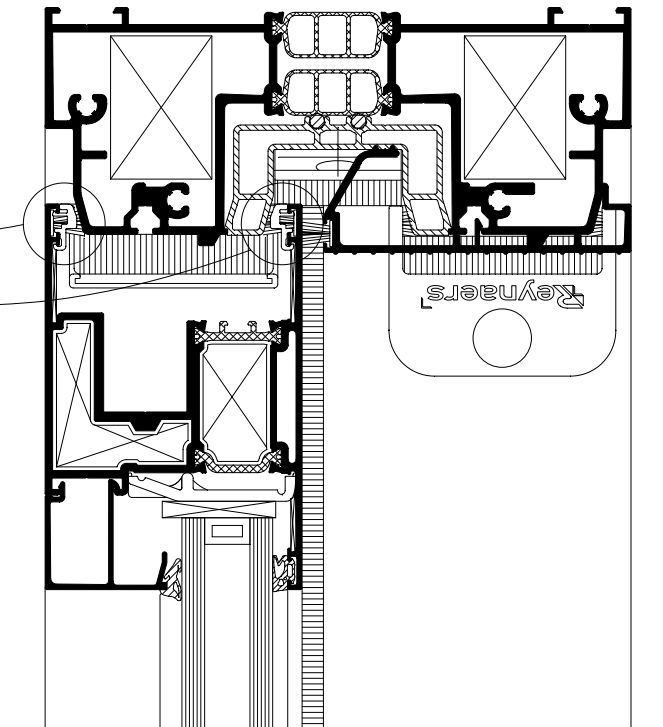

D0075263

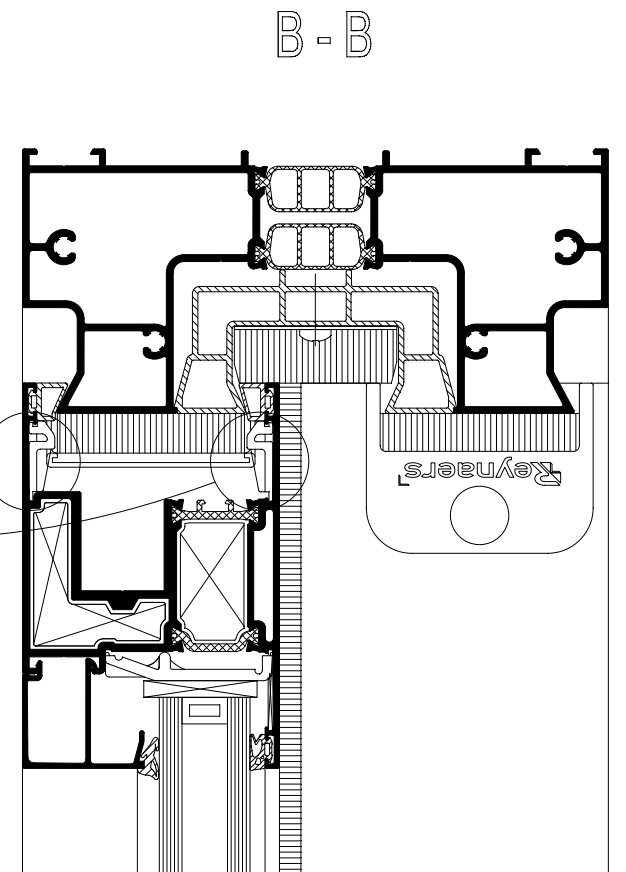
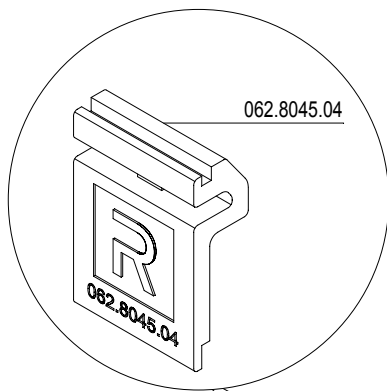
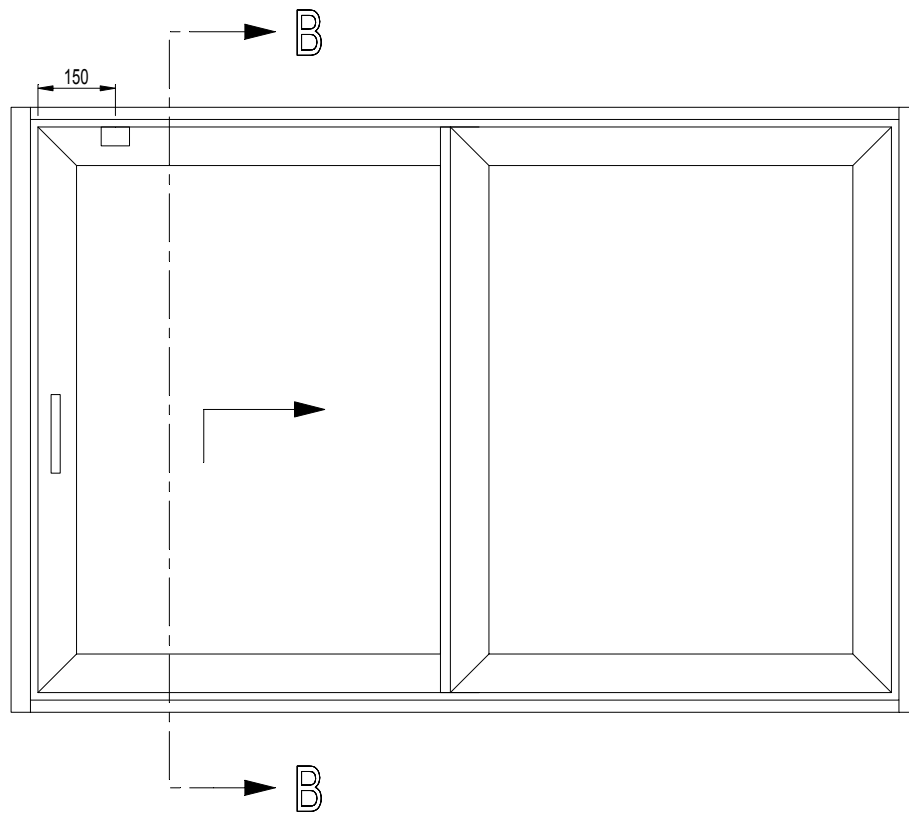
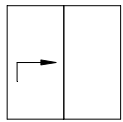

D0075263

CP 155-AP
CP 155-LS/AP

MONTAGE HULPPROFIEL INBRAAKWEREND
MONTAGE PROFILE DE RACCORDEMENT PROTECTION ANTI-VOL
MONTAGE HULPPROFIEL INBRAAKWEREND
MONTAGE ZUSATZPROFILE EINBRUCHHEMMEND



CP 155-AP CP 155-LS/AP

MONTAGE HULPPROFIEL INBRAAKWEREND
MONTAGE PROFILE DE RACCORDEMENT PROTECTION ANTI-VOL
MONTAGE HULPPROFIEL INBRAAKWEREND
MONTAGE ZUSATZPROFILE EINBRUCHHEMMEND

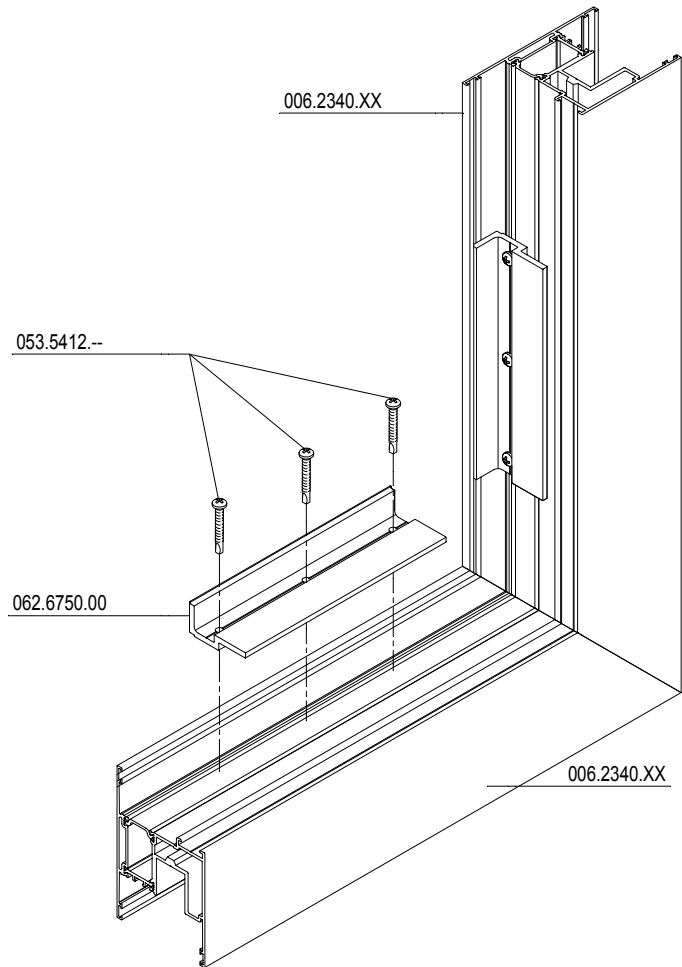
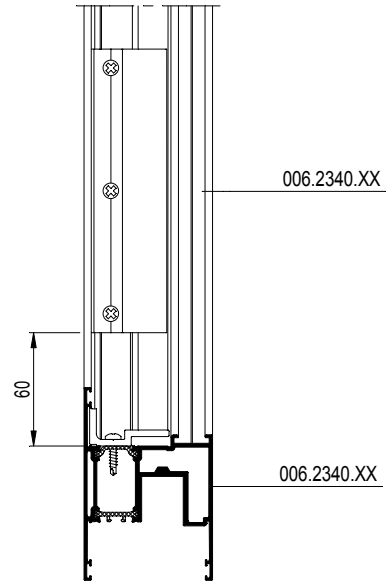
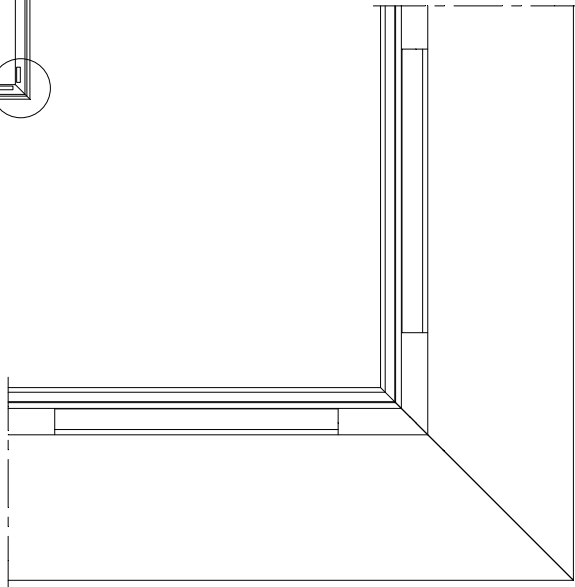
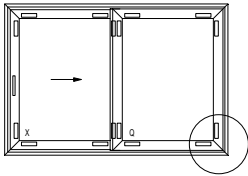

Glaslat Parclose Glazing bead Glasleiste	Beglazingsrubber binnen Joint de vitrage intérieur Glazing gasket inside Verglasungsdichtung innen	Glasdikte Épaisseur de vitrage Glazing thickness Glasdicke	Beglazingsrubber buiten Joint de vitrage extérieur Glazing gasket outside Verglasungsdichtung außen
030.3619.XX	080.9128.04	4	080.9114.SY (*)
030.3619.XX	080.9128.04	5	080.9114.SY (*)
030.3619.XX	080.9126.SY	6	080.9114.SY (*)
030.3619.XX	080.9126.SY	7	080.9114.SY (*)
030.3619.XX	080.9125.SY	8	080.9114.SY (*)
030.3619.XX	080.9124.SY	9	080.9114.SY (*)
030.3618.XX	080.9126.SY	10	080.9114.SY (*)
030.3618.XX	080.9125.SY	11	080.9114.SY (*)
030.3618.XX	080.9124.SY	12	080.9114.SY (*)
030.3617.XX	080.9126.SY	13	080.9114.SY (*)
030.3617.XX	080.9125.SY	14	080.9114.SY (*)
030.3617.XX	080.9124.SY	15	080.9114.SY (*)
030.3616.XX	080.9126.SY	16	080.9114.SY (*)
030.3616.XX	080.9125.SY	17	080.9114.SY (*)
030.3616.XX	080.9124.SY	18	080.9114.SY (*)
030.3615.XX	080.9126.SY	19	080.9114.SY (*)
030.3615.XX	080.9125.SY	20	080.9114.SY (*)
030.3615.XX	080.9124.SY	21	080.9114.SY (*)
030.3614.XX	080.9126.SY	22	080.9114.SY (*)
030.3614.XX	080.9125.SY	23	080.9114.SY (*)
030.3614.XX	080.9124.SY	24	080.9114.SY (*)
030.3613.XX	080.9126.SY	25	080.9114.SY (*)
030.3613.XX	080.9125.SY	26	080.9114.SY (*)
030.3613.XX	080.9124.SY	27	080.9114.SY (*)
030.3612.XX	080.9126.SY	28	080.9114.SY (*)
030.3612.XX	080.9125.SY	29	080.9114.SY (*)
030.3612.XX	080.9124.SY	30	080.9114.SY (*)
030.3611.XX	080.9126.SY	31	080.9114.SY (*)
030.3611.XX	080.9125.SY	32	080.9114.SY (*)
030.3611.XX	080.9124.SY	33	080.9114.SY (*)
030.3610.XX	080.9126.SY	34	080.9114.SY (*)
030.3610.XX	080.9125.SY	35	080.9114.SY (*)
030.3610.XX	080.9124.SY	36	080.9114.SY (*)
030.3609.XX	080.9126.SY	37	080.9114.SY (*)
030.3609.XX	080.9125.SY	38	080.9114.SY (*)
030.3609.XX	080.9124.SY	39	080.9114.SY (*)
030.3608.XX	080.9126.SY	40	080.9114.SY (*)
030.3608.XX	080.9125.SY	41	080.9114.SY (*)
030.3608.XX	080.9124.SY	42	080.9114.SY (*)
030.3607.XX	080.9126.SY	43 (!)	080.9114.SY (*)
030.3607.XX	080.9125.SY	44 (!)	080.9114.SY (*)
030.3607.XX	080.9124.SY	45 (!)	080.9114.SY (*)
030.3606.XX	080.9126.SY	46 (!)	080.9114.SY (*)
030.3606.XX	080.9125.SY	47 (!)	080.9114.SY (*)
030.3606.XX	080.9124.SY	48 (!)	080.9114.SY (*)
030.3200.XX	080.9128.04	49 (!)	080.9114.SY (*)
030.3200.XX	080.9126.SY	50 (!)	080.9114.SY (*)
030.3200.XX	080.9125.SY	51 (!)	080.9114.SY (*)
030.3200.XX	080.9124.SY	52 (!)	080.9114.SY (*)

Glaslat Parclose Glazing bead Glasleiste	Beglazingsrubber binnen Joint de vitrage intérieur Glazing gasket inside Verglasungsdichtung innen	Glasdikte Épaisseur de vitrage Glazing thickness Glasdicke	Beglazingsrubber buiten Joint de vitrage extérieur Glazing gasket outside Verglasungsdichtung außen
005.0276.XX	080.9130.04	21	080.9120.04
005.0276.XX	080.9128.04	22	080.9120.04
005.0276.XX	080.9130.04	23	080.9118.04
005.0276.XX	080.9128.04	24	080.9118.04
005.0276.XX	080.9130.04	25	080.9116.04
005.0276.XX	080.9128.04	26	080.9116.04
005.0276.XX	080.9130.04	27	080.9114.SY (*)
005.0276.XX	080.9128.04	28	080.9114.SY (*)
005.0276.XX	080.9128.04	29	080.9114.SY (*)
005.0276.XX	080.9126.SY	30	080.9114.SY (*)
005.0276.XX	080.9126.SY	31	080.9114.SY (*)
005.0276.XX	080.9125.SY	32	080.9114.SY (*)
005.0276.XX	080.9124.SY	33	080.9114.SY (*)

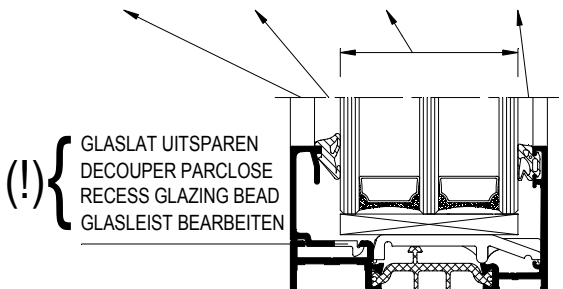
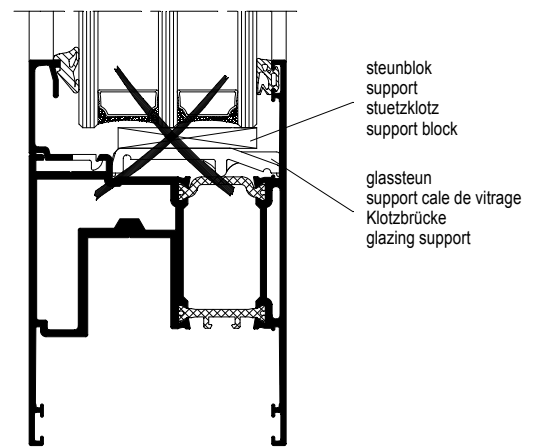
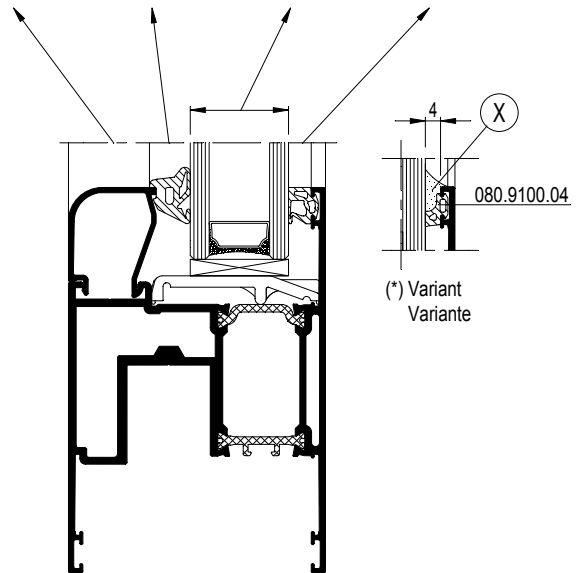

(!) GLASLAT UITSPAREN
DECOUPER PARCLOSE
RECESS GLAZING BEAD
GLASLEIST BEARBEITEN

(*) Variant
Variante

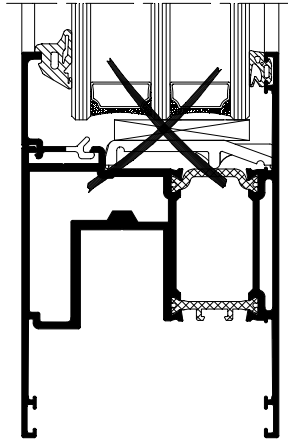

(!) GLASLAT UITSPAREN
DECOUPER PARCLOSE
RECESS GLAZING BEAD
GLASLEIST BEARBEITEN

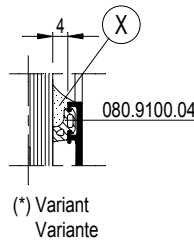
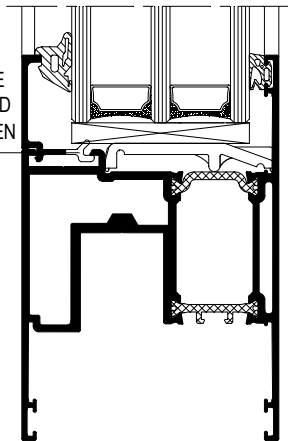

Glaslat Parclose Glazing bead Glasleiste	Beglazingsrubber binnen Joint de vitrage intérieur Glazing gasket inside Verglasungsdichtung innen	Glasdikte Epaisseur de vitrage Glazing thickness Glasdicke	Beglazingsrubber buiten Joint de vitrage extérieur Glazing gasket outside Verglasungsdichtung aussen
030.3650.XX	080.9128.04	26	080.9120.04
030.3650.XX	080.9128.04	27	080.9120.04
030.3650.XX	080.9128.04	28	080.9118.04
030.3650.XX	080.9128.04	29	080.9118.04
030.3650.XX	080.9128.04	30	080.9116.04
030.3650.XX	080.9128.04	31	080.9116.04
030.3650.XX	080.9128.04	32	080.9114.SY
030.3650.XX	080.9128.04	33	080.9114.SY
030.3650.XX	080.9126.SY	34	080.9114.SY
030.3649.XX	080.9128.04	35	080.9114.SY
030.3649.XX	080.9128.04	36	080.9114.SY
030.3649.XX	080.9126.SY	37	080.9114.SY
030.3648.XX	080.9128.04	38	080.9114.SY
030.3648.XX	080.9128.04	39	080.9114.SY
030.3648.XX	080.9126.SY	40	080.9114.SY
030.3647.XX	080.9128.04	41	080.9114.SY
030.3647.XX	080.9128.04	42	080.9114.SY
030.3647.XX	080.9126.SY	43	080.9114.SY
030.3646.XX	080.9128.04	44 (!)	080.9114.SY
030.3646.XX	080.9128.04	45 (!)	080.9114.SY
030.3646.XX	080.9126.SY	46 (!)	080.9114.SY
030.3645.XX	080.9128.04	47 (!)	080.9114.SY
030.3645.XX	080.9128.04	48 (!)	080.9114.SY
030.3645.XX	080.9126.SY	49 (!)	080.9114.SY
030.3644.XX	080.9128.04	50 (!)	080.9114.SY
030.3644.XX	080.9128.04	51 (!)	080.9114.SY
030.3644.XX	080.9126.SY	52 (!)	080.9114.SY
030.3644.XX	080.9126.SY	53 (!)	080.9114.SY

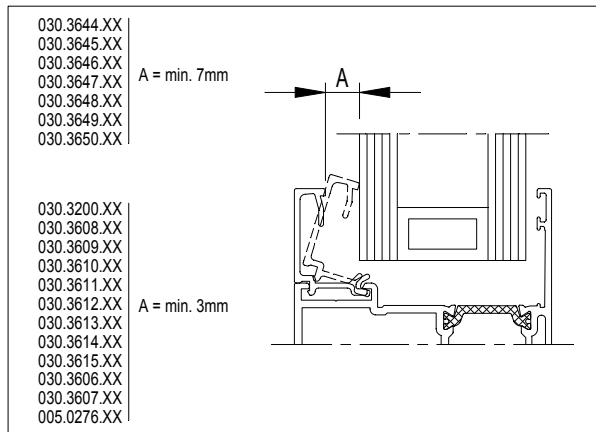
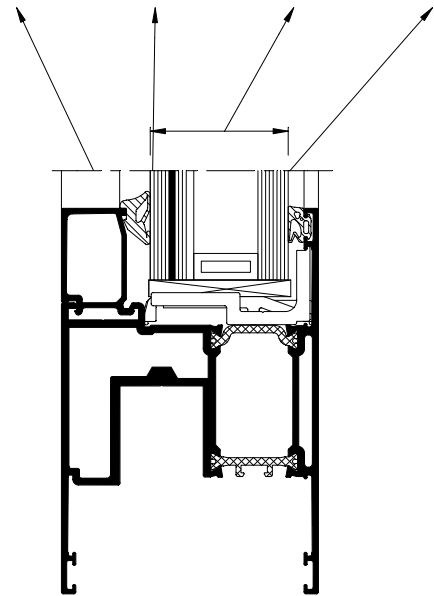

(X) DICHTINGSMIDDEL
MATIERE D'ETANCHEITE
SEALING AGENT
ABDICHTUNG

Buitenkader
Dormant

Outer frame
Blendrahmen



Buitenkader
Dormant

Outer frame
Blendrahmen



Glaslat Parclose Glazing bead Glasleiste	Beglazingsrubber binnen Joint de vitrage intérieur Glazing gasket inside Verglasungsdichtung innen	Glasdikte Epaisseur de vitrage Glazing thickness Glasdicke	Beglazingsrubber buiten Joint de vitrage extérieur Glazing gasket outside Verglasungsdichtung aussen
030.3619.XX	080.9130.04	6	080.9120.04
030.3619.XX	080.9128.04	7	080.9120.04
030.3619.XX	080.9128.04	8	080.9120.04
030.3619.XX	080.9126.SY	9	080.9120.04
030.3619.XX	080.9128.04	10	080.9118.04
030.3619.XX	080.9126.SY	11	080.9118.04
030.3619.XX	080.9126.SY	12	080.9118.04
030.3619.XX	080.9126.SY	13	080.9116.04
030.3619.XX	080.9126.SY	14	080.9116.04
030.3619.XX	080.9125.SY	15	080.9116.04
030.3619.XX	080.9126.SY	16	080.9114.SY (*)
030.3619.XX	080.9125.SY	17	080.9114.SY (*)
030.3619.XX	080.9124.SY	18	080.9114.SY (*)
030.3618.XX	080.9126.SY	19	080.9114.SY (*)
030.3618.XX	080.9125.SY	20	080.9114.SY (*)
030.3618.XX	080.9124.SY	21	080.9114.SY (*)
030.3617.XX	080.9126.SY	22	080.9114.SY (*)
030.3617.XX	080.9125.SY	23	080.9114.SY (*)
030.3617.XX	080.9124.SY	24	080.9114.SY (*)
030.3616.XX	080.9126.SY	25	080.9114.SY (*)
030.3616.XX	080.9125.SY	26	080.9114.SY (*)
030.3616.XX	080.9124.SY	27	080.9114.SY (*)
030.3615.XX	080.9126.SY	28	080.9114.SY (*)
030.3615.XX	080.9125.SY	29	080.9114.SY (*)
030.3615.XX	080.9124.SY	30	080.9114.SY (*)
030.3614.XX	080.9126.SY	31	080.9114.SY (*)
030.3614.XX	080.9125.SY	32	080.9114.SY (*)
030.3614.XX	080.9124.SY	33	080.9114.SY (*)
030.3613.XX	080.9126.SY	34	080.9114.SY (*)
030.3613.XX	080.9125.SY	35	080.9114.SY (*)
030.3613.XX	080.9124.SY	36	080.9114.SY (*)
030.3612.XX	080.9126.SY	37	080.9114.SY (*)
030.3612.XX	080.9125.SY	38	080.9114.SY (*)
030.3612.XX	080.9124.SY	39	080.9114.SY (*)
030.3611.XX	080.9126.SY	40	080.9114.SY (*)
030.3611.XX	080.9125.SY	41	080.9114.SY (*)
030.3611.XX	080.9124.SY	42	080.9114.SY (*)
030.3610.XX	080.9126.SY	43	080.9114.SY (*)
030.3610.XX	080.9125.SY	44	080.9114.SY (*)
030.3610.XX	080.9124.SY	45	080.9114.SY (*)
030.3609.XX	080.9126.SY	46	080.9114.SY (*)
030.3609.XX	080.9125.SY	47	080.9114.SY (*)
030.3609.XX	080.9124.SY	48	080.9114.SY (*)
030.3608.XX	080.9126.SY	49	080.9114.SY (*)
030.3608.XX	080.9125.SY	50	080.9114.SY (*)
030.3608.XX	080.9124.SY	51	080.9114.SY (*)

Glaslat Parclose Glazing bead Glasleiste	Beglazingsrubber binnen Joint de vitrage intérieur Glazing gasket inside Verglasungsdichtung innen	Glasdikte Epaisseur de vitrage Glazing thickness Glasdicke	Beglazingsrubber buiten Joint de vitrage extérieur Glazing gasket outside Verglasungsdichtung aussen
030.3607.XX	080.9126.SY	52 (!)	080.9114.SY (*)
030.3607.XX	080.9125.SY	53 (!)	080.9114.SY (*)
030.3607.XX	080.9124.SY	54 (!)	080.9114.SY (*)
030.3606.XX	080.9126.SY	55 (!)	080.9114.SY (*)
030.3606.XX	080.9125.SY	56 (!)	080.9114.SY (*)
030.3606.XX	080.9124.SY	57 (!)	080.9114.SY (*)
030.3200.XX	080.9126.SY	58 (!)	080.9114.SY (*)
030.3200.XX	080.9126.SY	59 (!)	080.9114.SY (*)
030.3200.XX	080.9125.SY	60 (!)	080.9114.SY (*)
030.3200.XX	080.9124.SY	61 (!)	080.9114.SY (*)

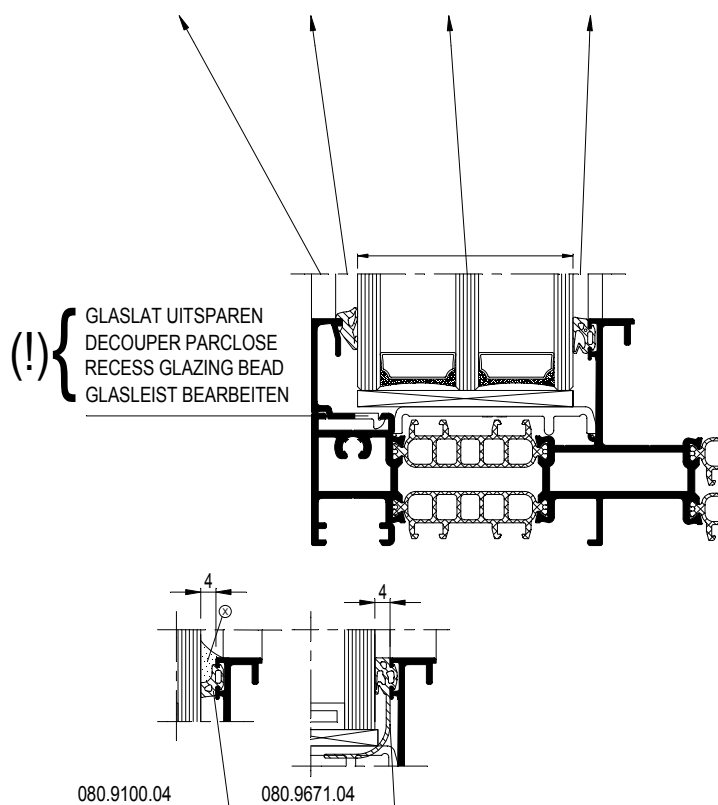

(*) Variant
Variante

Buitenkader
Dormant

Outer frame
Blendrahmen



Buitenkader
Dormant

Outer frame
Blendrahmen



Glaslat Parclose Glazing bead Glasleiste	Beglazingsrubber binnen Joint de vitrage intérieur Glazing gasket inside Verglasungsdichtung innen	Glasdikte Epaisseur de vitrage Glazing thickness Glasdicke	Beglazingsrubber buiten Joint de vitrage extérieur Glazing gasket outside Verglasungsdichtung aussen
030.3619.XX	080.9372.04	10	080.9120.04
030.3619.XX	080.9372.04	11	080.9120.04
030.3619.XX	080.9372.04	12	080.9118.04
030.3619.XX	080.9372.04	13	080.9118.04
030.3619.XX	080.9372.04	14	080.9116.04
030.3619.XX	080.9372.04	15	080.9116.04
030.3619.XX	080.9372.04	16	080.9114.SY (*)
030.3619.XX	080.9372.04	17	080.9114.SY (*)
030.3619.XX	080.9372.04	18	080.9114.SY (*)
030.3618.XX	080.9372.04	19	080.9114.SY (*)
030.3618.XX	080.9372.04	20	080.9114.SY (*)
030.3618.XX	080.9372.04	21	080.9114.SY (*)
030.3617.XX	080.9372.04	22	080.9114.SY (*)
030.3617.XX	080.9372.04	23	080.9114.SY (*)
030.3617.XX	080.9372.04	24	080.9114.SY (*)
030.3616.XX	080.9372.04	25	080.9114.SY (*)
030.3616.XX	080.9372.04	26	080.9114.SY (*)
030.3616.XX	080.9372.04	27	080.9114.SY (*)
030.3615.XX	080.9372.04	28	080.9114.SY (*)
030.3615.XX	080.9372.04	29	080.9114.SY (*)
030.3615.XX	080.9372.04	30	080.9114.SY (*)
030.3614.XX	080.9372.04	31	080.9114.SY (*)
030.3614.XX	080.9372.04	32	080.9114.SY (*)
030.3614.XX	080.9372.04	33	080.9114.SY (*)
030.3613.XX	080.9372.04	34	080.9114.SY (*)
030.3613.XX	080.9372.04	35	080.9114.SY (*)
030.3613.XX	080.9372.04	36	080.9114.SY (*)
030.3612.XX	080.9372.04	37	080.9114.SY (*)
030.3612.XX	080.9372.04	38	080.9114.SY (*)
030.3612.XX	080.9372.04	39	080.9114.SY (*)
030.3611.XX	080.9372.04	40	080.9114.SY (*)
030.3611.XX	080.9372.04	41	080.9114.SY (*)
030.3611.XX	080.9372.04	42	080.9114.SY (*)
030.3610.XX	080.9372.04	43	080.9114.SY (*)
030.3610.XX	080.9372.04	44	080.9114.SY (*)
030.3610.XX	080.9372.04	45	080.9114.SY (*)
030.3609.XX	080.9372.04	46	080.9114.SY (*)
030.3609.XX	080.9372.04	47	080.9114.SY (*)
030.3609.XX	080.9372.04	48	080.9114.SY (*)
030.3608.XX	080.9372.04	49	080.9114.SY (*)
030.3608.XX	080.9372.04	50	080.9114.SY (*)
030.3608.XX	080.9372.04	51	080.9114.SY (*)
030.3607.XX	080.9372.04	52 (!)	080.9114.SY (*)
030.3607.XX	080.9372.04	53 (!)	080.9114.SY (*)
030.3607.XX	080.9372.04	54 (!)	080.9114.SY (*)
030.3606.XX	080.9372.04	55 (!)	080.9114.SY (*)

Glaslat Parclose Glazing bead Glasleiste	Beglazingsrubber binnen Joint de vitrage intérieur Glazing gasket inside Verglasungsdichtung innen	Glasdikte Epaisseur de vitrage Glazing thickness Glasdicke	Beglazingsrubber buiten Joint de vitrage extérieur Glazing gasket outside Verglasungsdichtung aussen
030.3606.XX	080.9372.04	56 (!)	080.9114.SY (*)
030.3606.XX	080.9372.04	57 (!)	080.9114.SY (*)
030.3200.XX	080.9372.04	58 (!)	080.9116.04
030.3200.XX	080.9372.04	59 (!)	080.9116.04
030.3200.XX	080.9372.04	60 (!)	080.9114.SY (*)
030.3200.XX	080.9372.04	61 (!)	080.9114.SY (*)

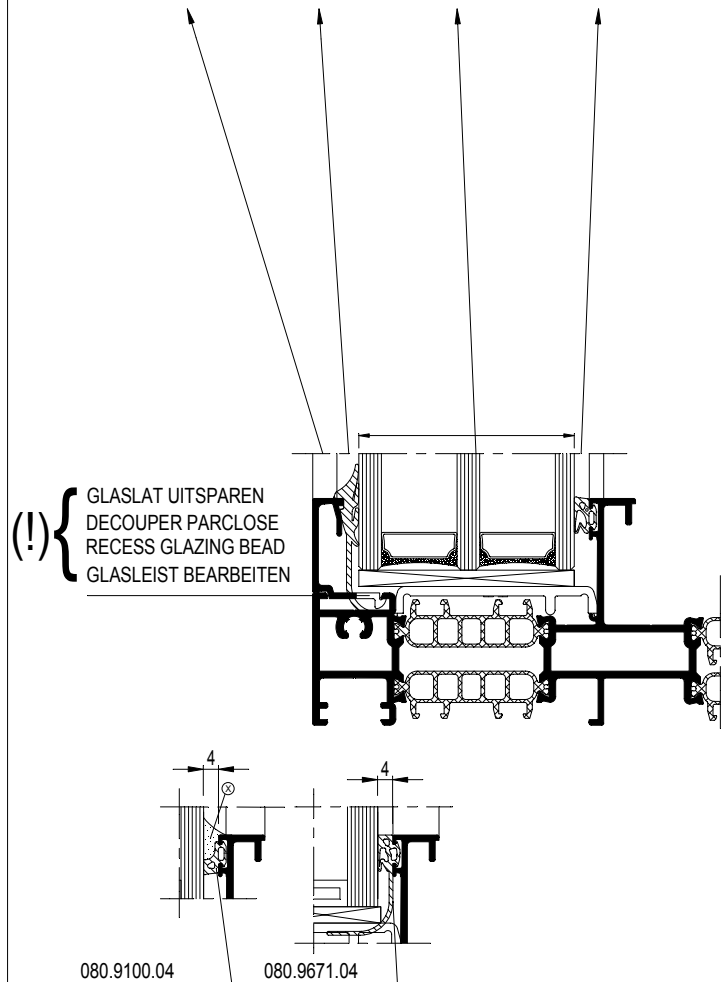

(*) Variant
Variante

CP 155 CP 155-LS

MAX. TOELAATBARE AFMETINGEN VLEUGELS
DIMENSIONS MAX. ADMISSIBLE OUVRANTS
MAX. ADMISSIBLE SIZES VENTS
MAX. ZULAESSIGE ABMESSUNGEN FLUEGELS

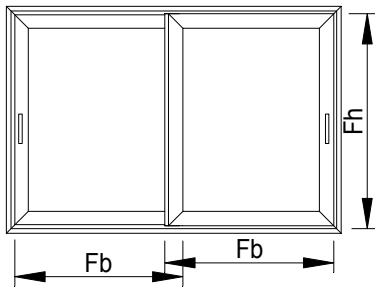

1

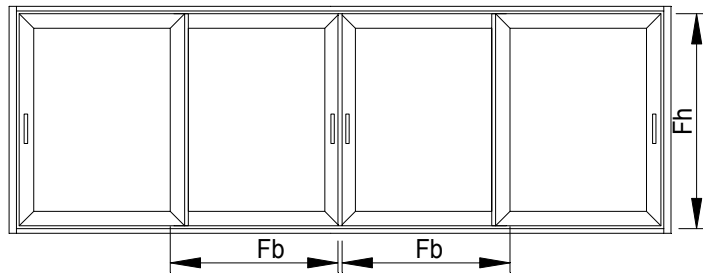

2

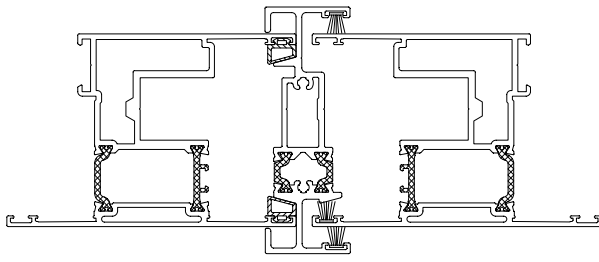

lx = 110,9cm*

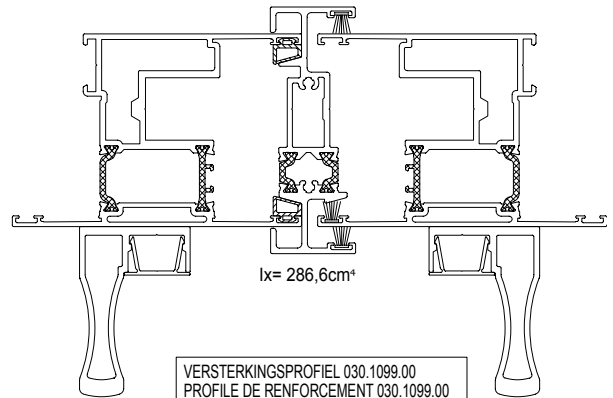

lx = 286,6cm*

VERSTERKINGSPROFIEL 030.1099.00
PROFILE DE RENFORCEMENT 030.1099.00
REINFORCEMENT PROFILE 030.1099.00
VERSTAERKUNGSPROFIL 030.1099.00

3

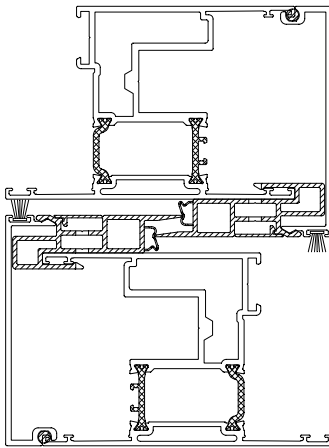

lx = 116,4cm*

4

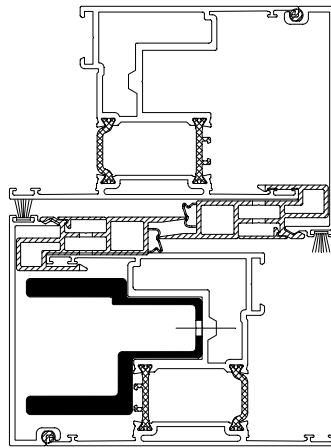

lx = 131,0cm*

5

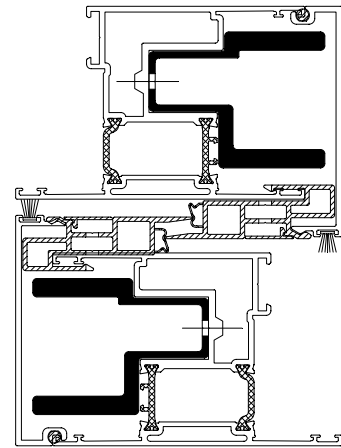

lx = 145,5cm*

VERSTERKINGSPROFIEL 006.1343.00
PROFILE DE RENFORCEMENT 006.1343.00
REINFORCEMENT PROFILE 006.1343.00
VERSTAERKUNGSPROFIL 006.1343.00

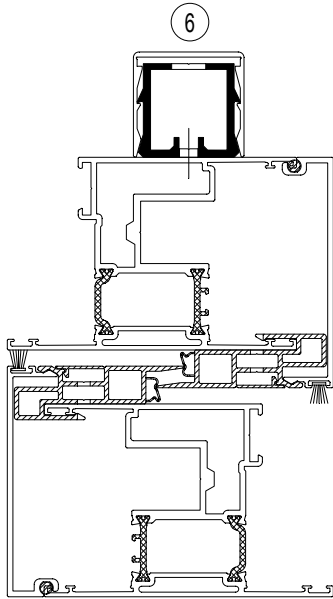

lx = 163,4cm⁴

VERSTERKINGSPROFIEL 030.1096.00
PROFILE DE RENFORCEMENT 030.1096.00
REINFORCEMENT PROFILE 030.1096.00
VERSTAERKUNGSPROFIL 030.1096.00

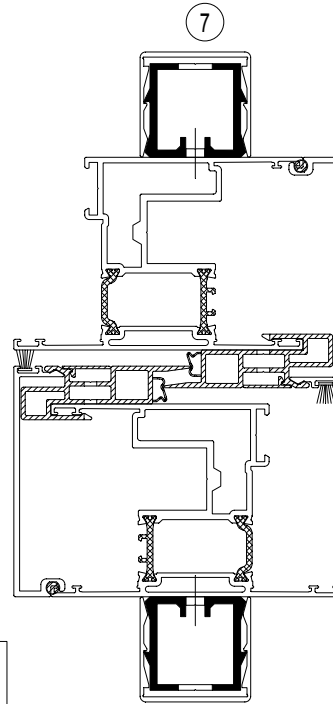

lx = 209,6cm⁴

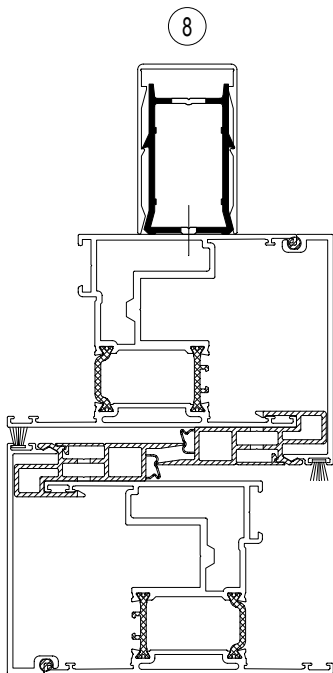

lx = 194,4cm⁴

VERSTERKINGSPROFIEL 030.1097.00
PROFILE DE RENFORCEMENT 030.1097.00
REINFORCEMENT PROFILE 030.1097.00
VERSTAERKUNGSPROFIL 030.1097.00

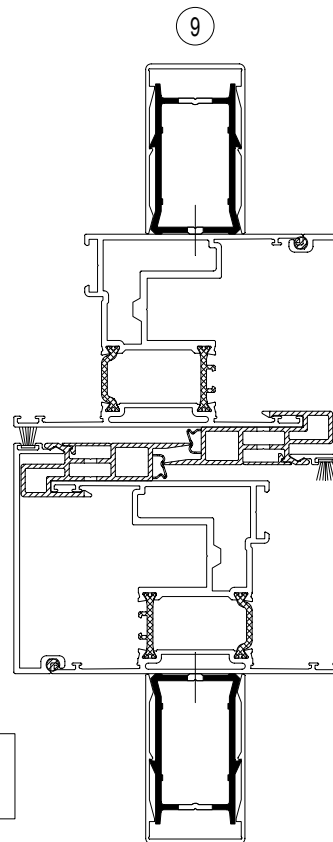

lx = 265,6cm⁴

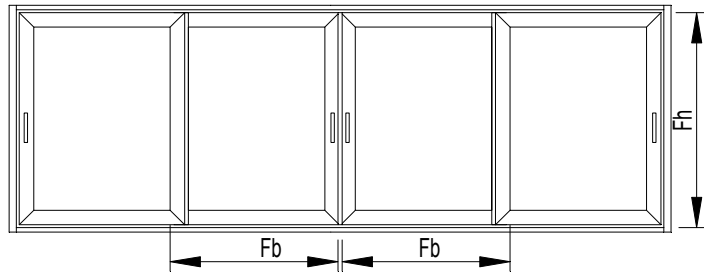
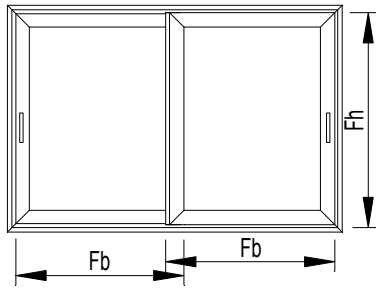

10

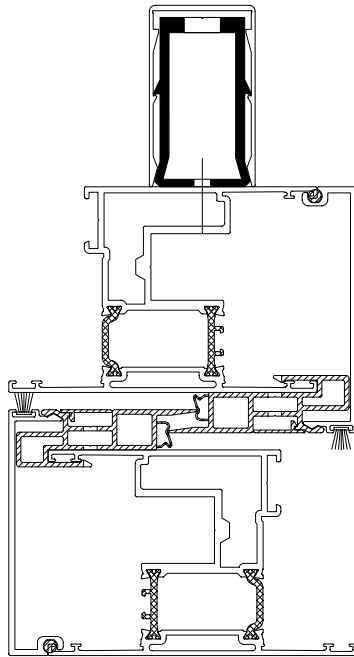

$l_x = 234,4\text{cm}^*$

11

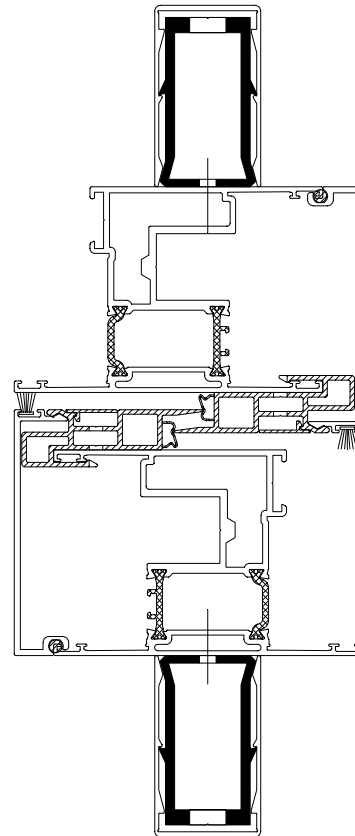

$l_x = 351,2\text{cm}^*$

VERSTERKINGSPROFIEL 030.1098.00
PROFILE DE RENFORCEMENT 030.1098.00
REINFORCEMENT PROFILE 030.1098.00
VERSTAERKUNGSPROFIL 030.1098.00

12

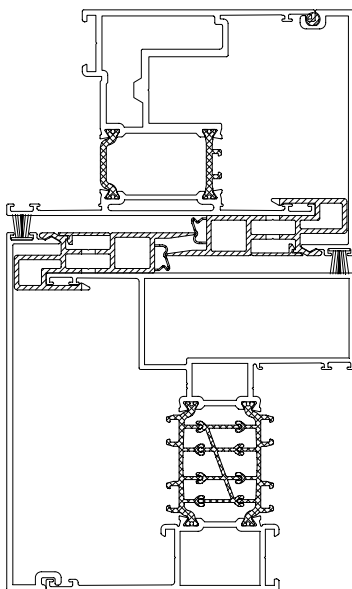

$l_x = 187,4\text{cm}^*$

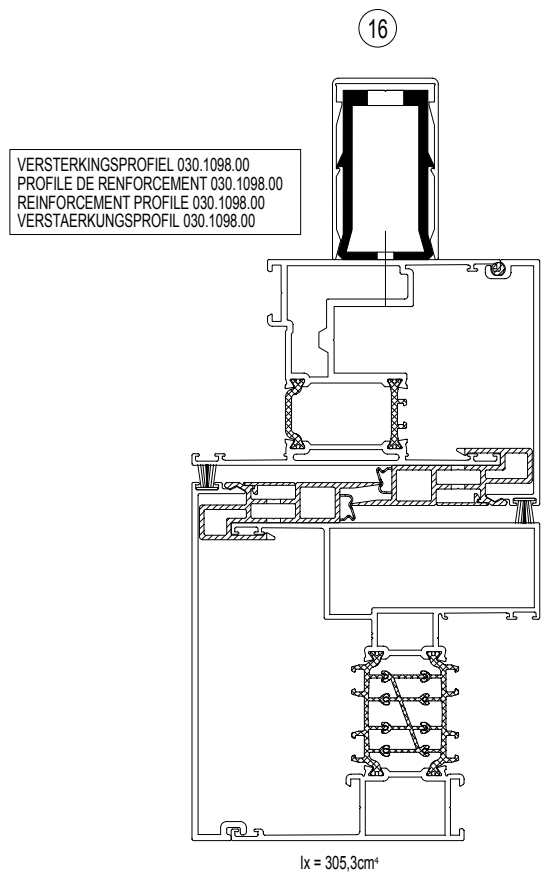
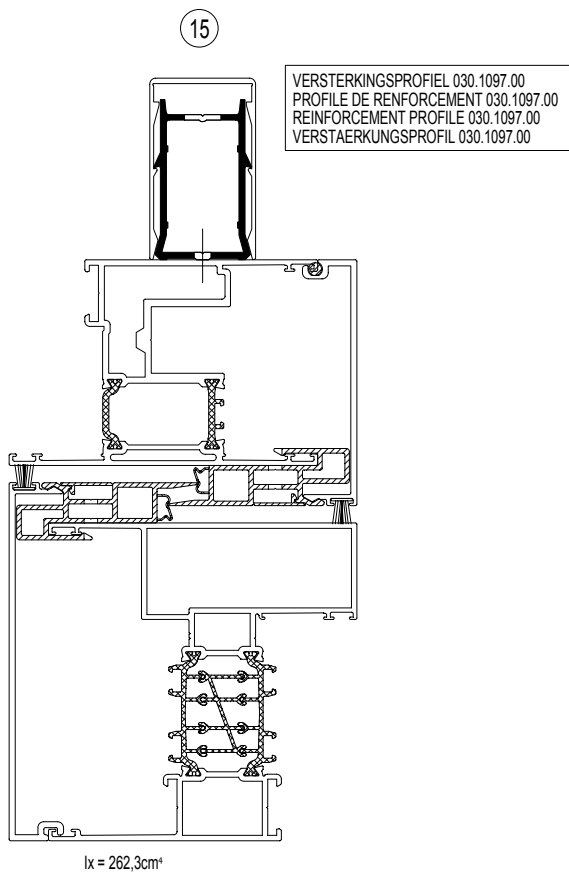
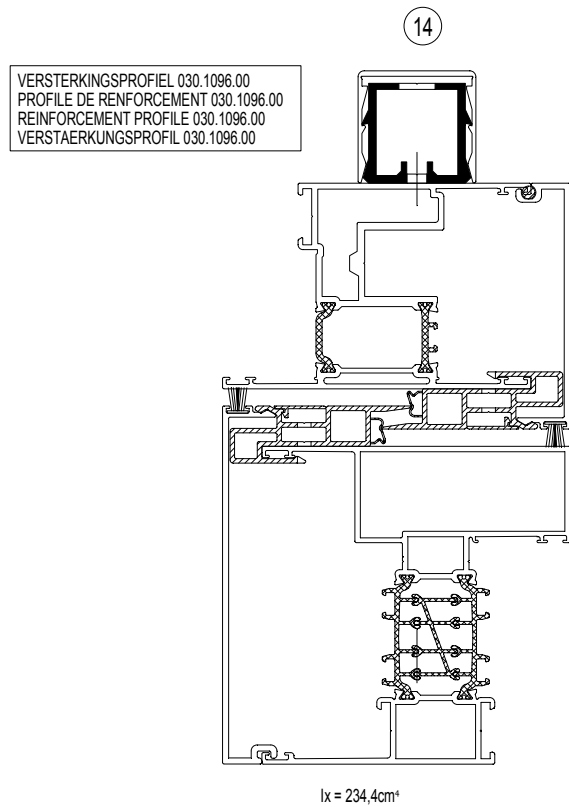
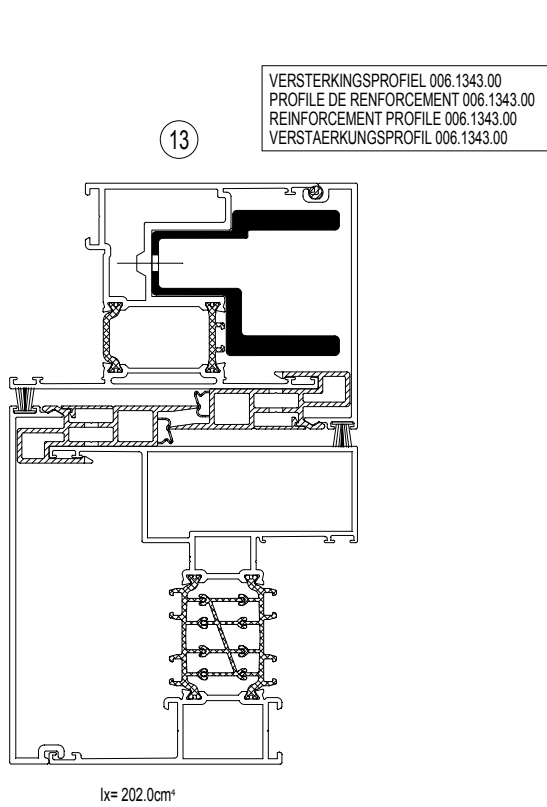

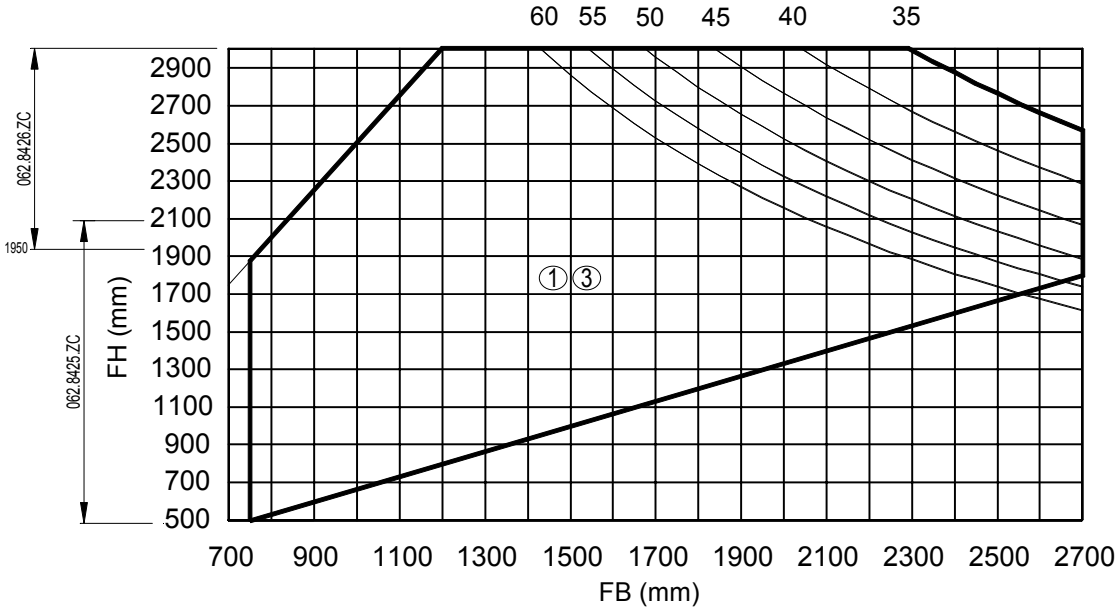

GLASGEWICHT (KG/M²)
 POIDS DE VERRE (KG/M²)
 GLASS WEIGHT (KG/M²)
 GLASGEWICHT (KG/M²)

$f_{max} = H / 150$;
 max.12 mm

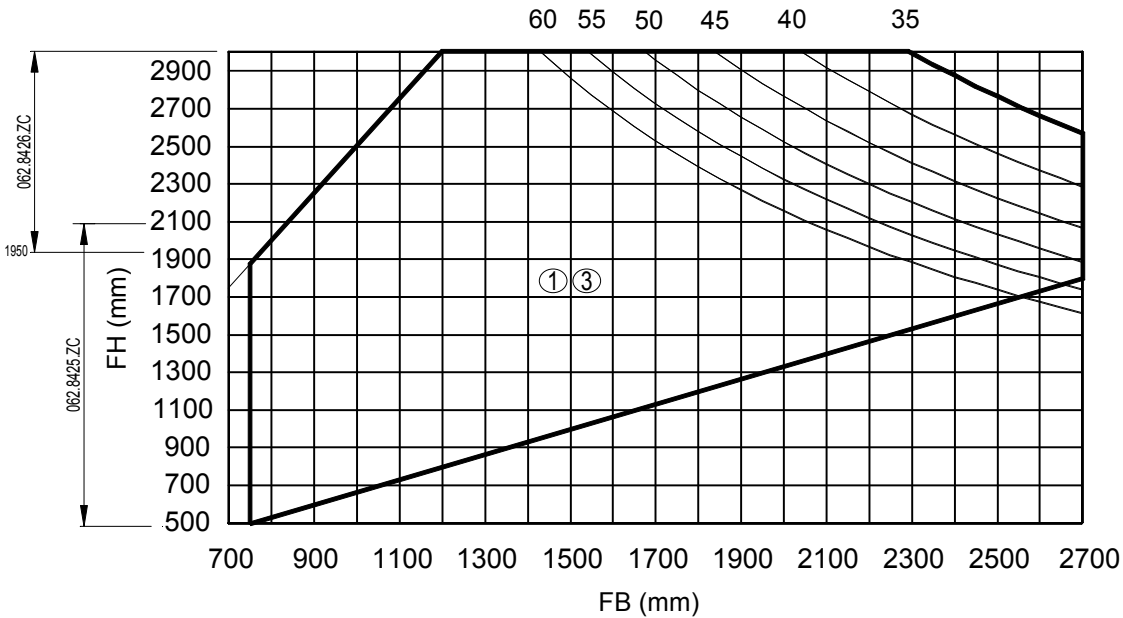

GLASGEWICHT (KG/M²)
 POIDS DE VERRE (KG/M²)
 GLASS WEIGHT (KG/M²)
 GLASGEWICHT (KG/M²)

$f_{max} = H / 200$;
 max.12mm

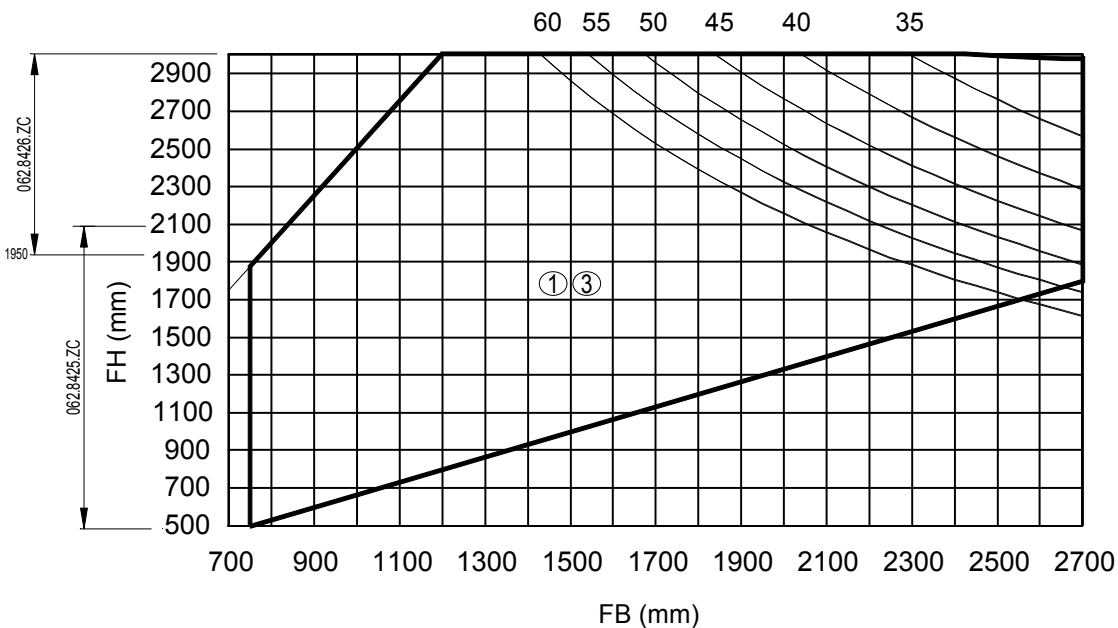

GLASGEWICHT (KG/M²)
 POIDS DE VERRE (KG/M²)
 GLASS WEIGHT (KG/M²)
 GLASGEWICHT (KG/M²)

$f_{max} = H / 300$;
 max.12 mm

P = 400Pa
 FG max = 250KG

P = WINDDRUK
 P = PRESSION DU VENT
 P = WINDDRUCK
 P = WIND PRESSURE
 FG = VLEUGELGEWICHT
 FG = POIDS DU VAINTAIL
 FG = FLÜGELGEWICHT
 FG = WEIGHT OF THE VENT
 f = DOORBUIGING
 f = FLEXION
 f = DURCHBIEGUNG
 f = DEFLECTION

D0013988

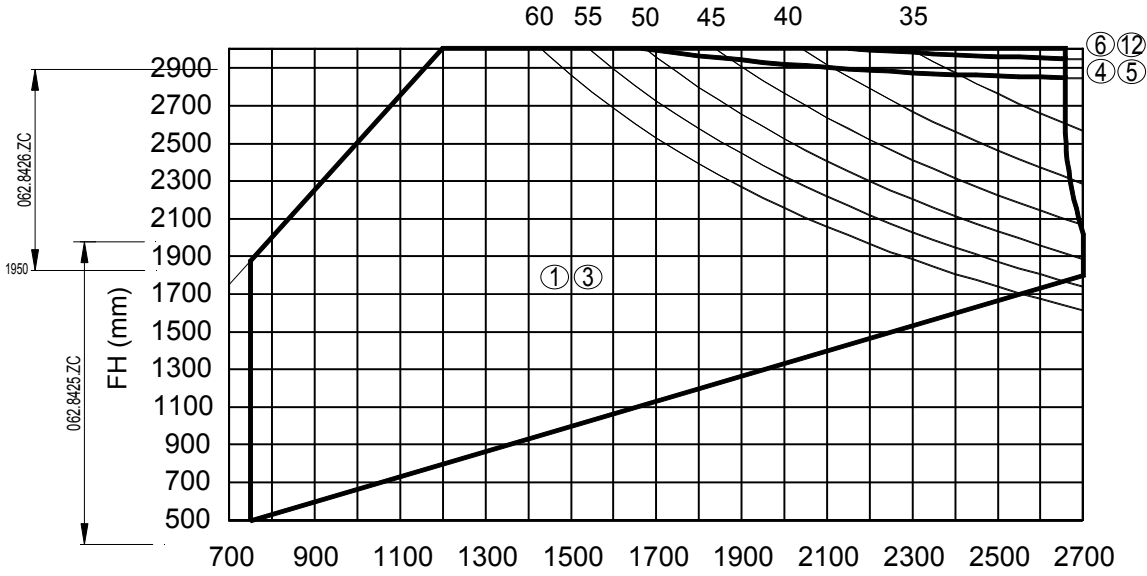

GLASGEWICHT (KG/M²)
 POIDS DE VERRE (KG/M²)
 GLASS WEIGHT (KG/M²)
 GLASGEWICHT (KG/M²)

$f_{max} = H / 150$;
 max.12mm

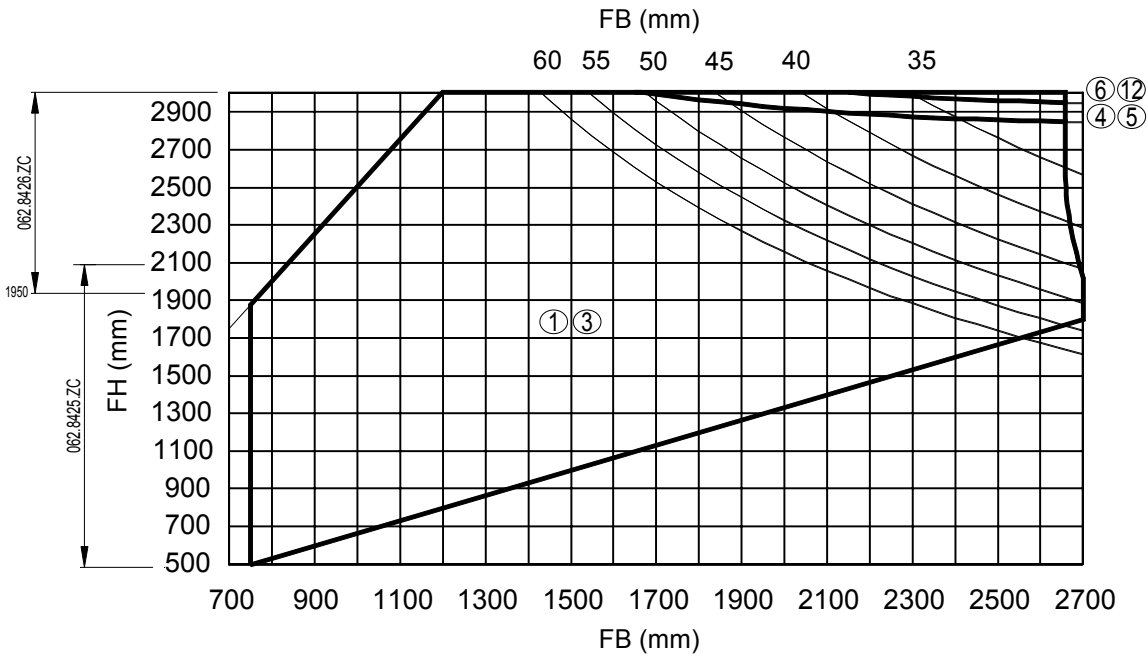

GLASGEWICHT (KG/M²)
 POIDS DE VERRE (KG/M²)
 GLASS WEIGHT (KG/M²)
 GLASGEWICHT (KG/M²)

$f_{max} = H / 200$;
 max.12 mm

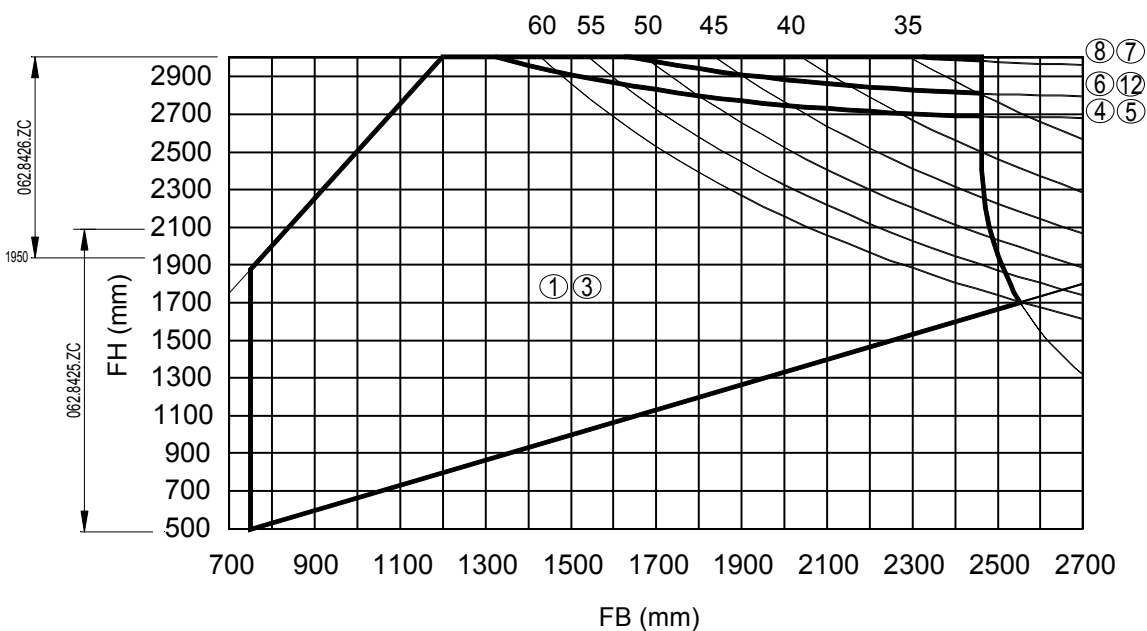

GLASGEWICHT (KG/M²)
 POIDS DE VERRE (KG/M²)
 GLASS WEIGHT (KG/M²)
 GLASGEWICHT (KG/M²)

$f_{max} = H / 300$;
 max.12 mm

P = 600Pa
FG max = 250KG

P = WINDDRUK
 P = PRESSION DU VENT
 P = WINDRUCK
 P = WIND PRESSURE
 FG = VLEUGELGEWICHT
 FG = POIDS DU VANTAIL
 FG = FLÜGELGEWICHT
 FG = WEIGHT OF THE VENT
 f = DOORBUIGING
 f = FLEXION
 f = DURCHBIEGUNG
 f = DEFLECTION

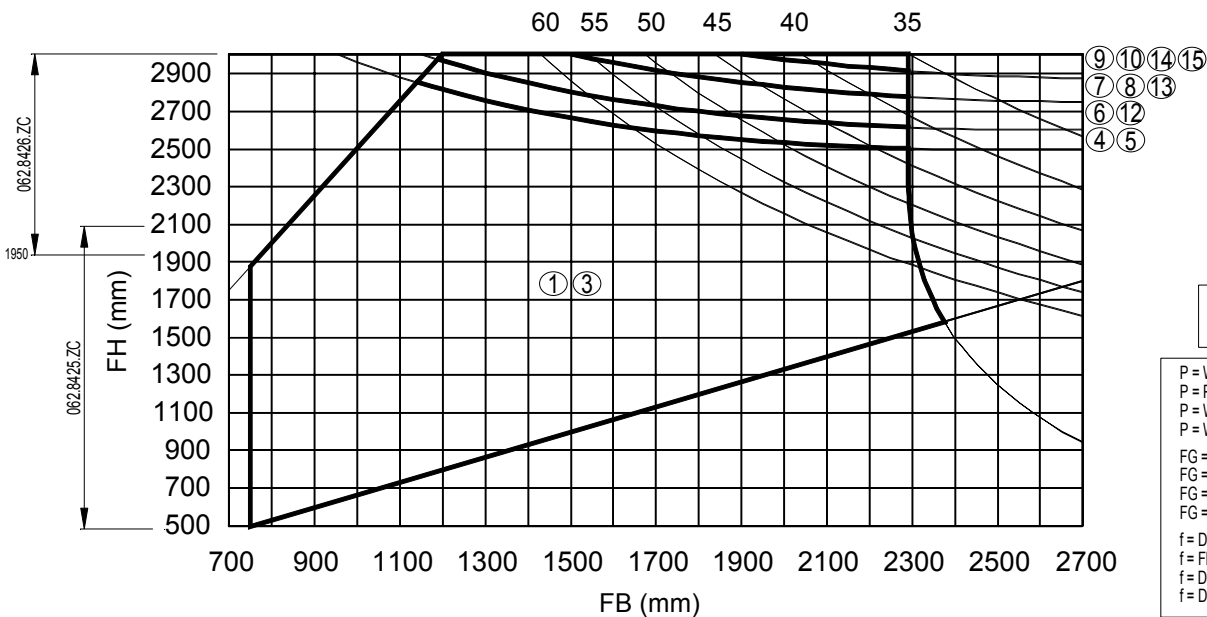
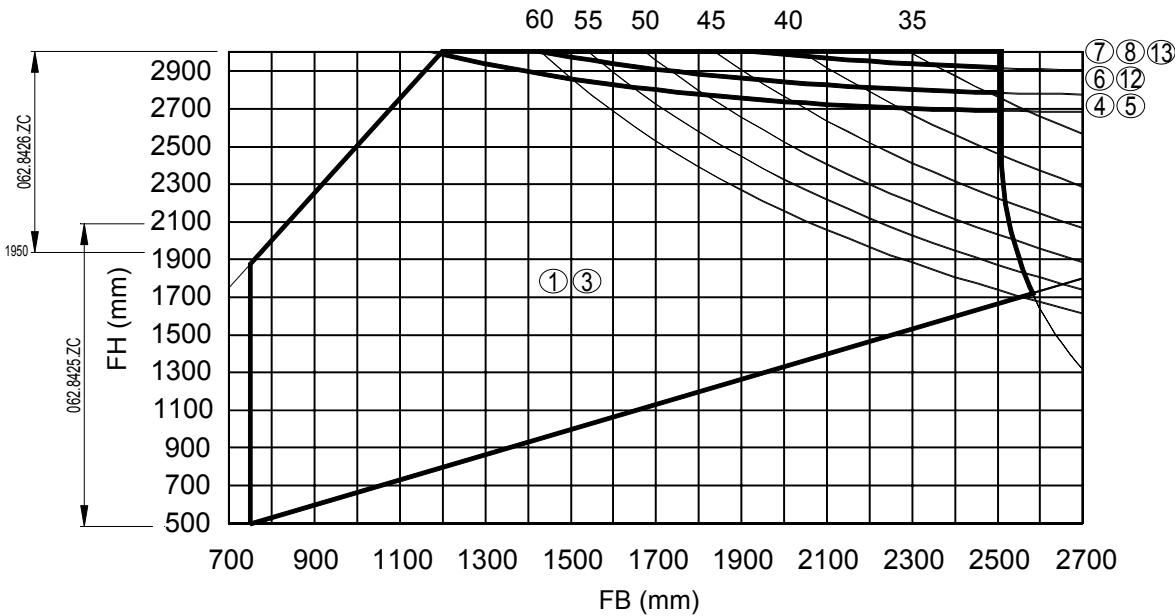
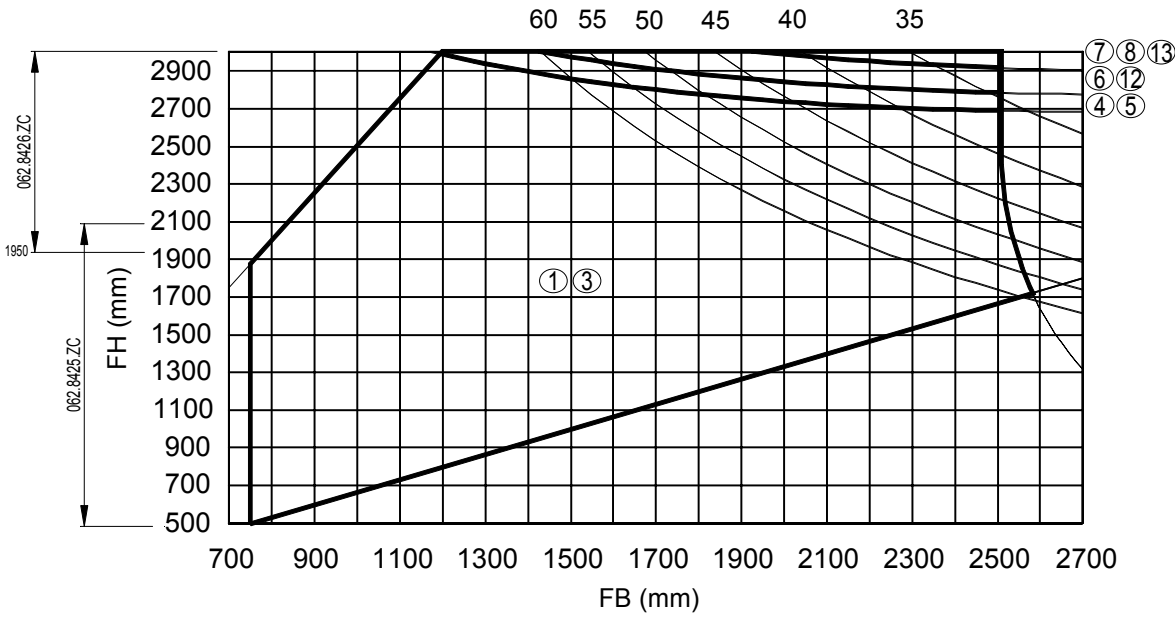

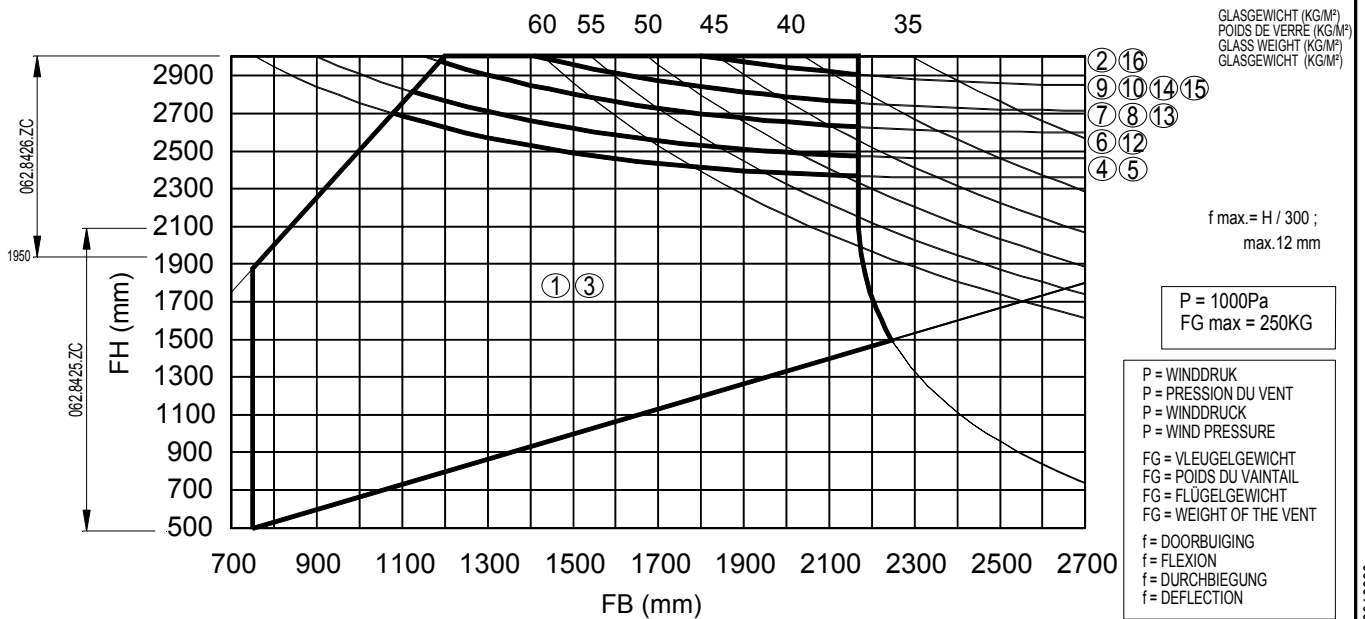
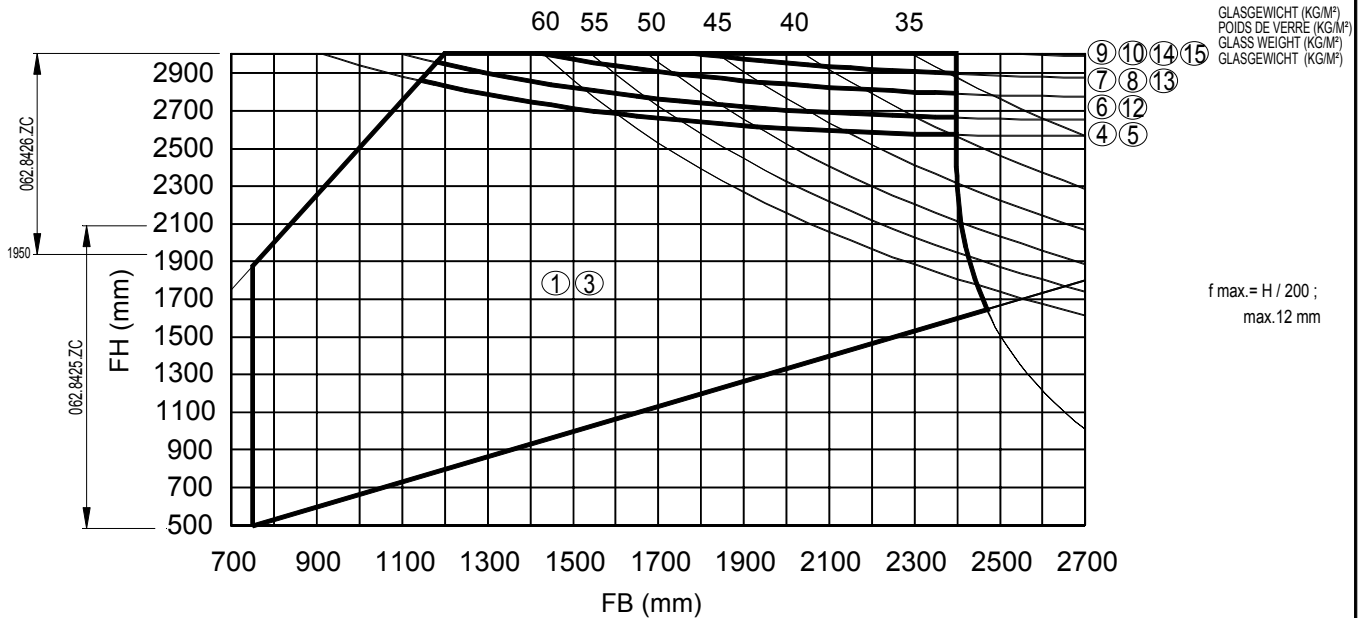
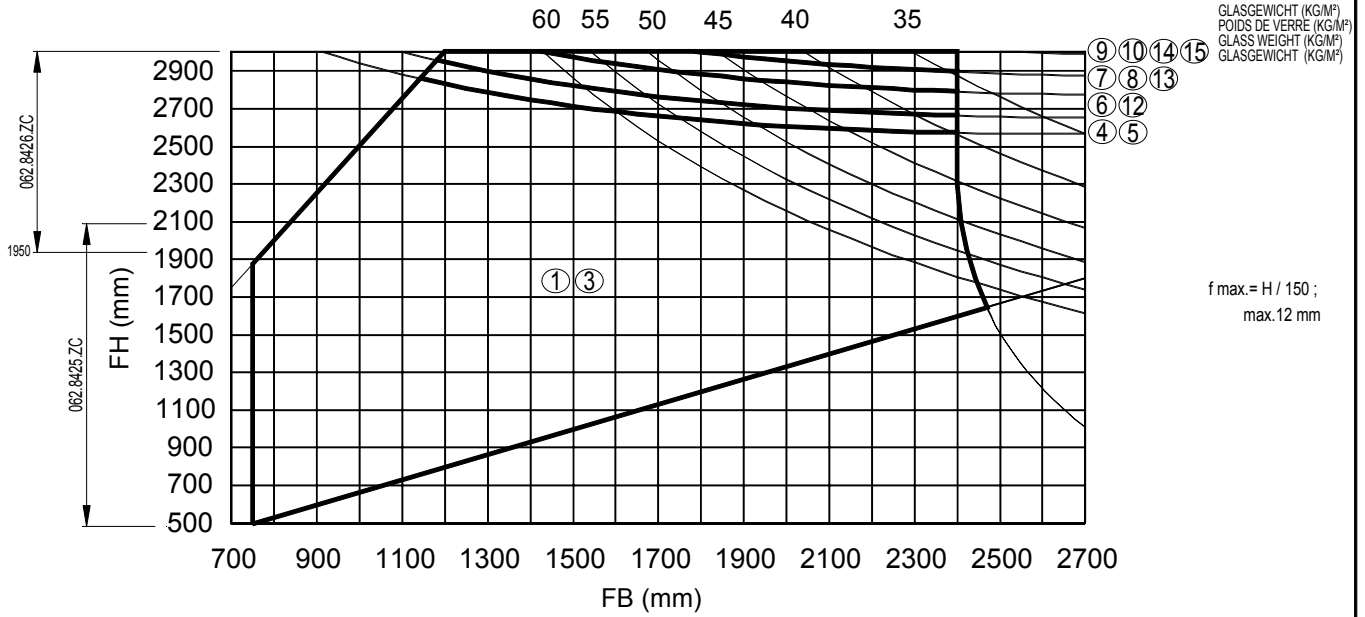

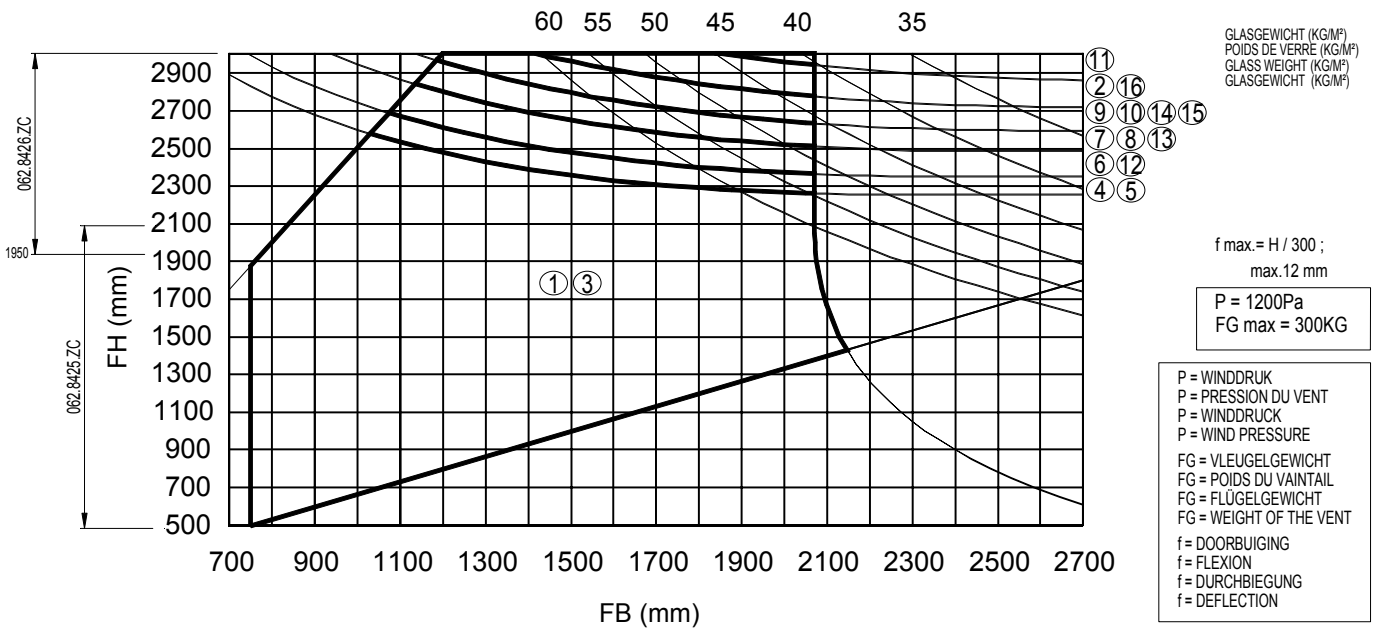
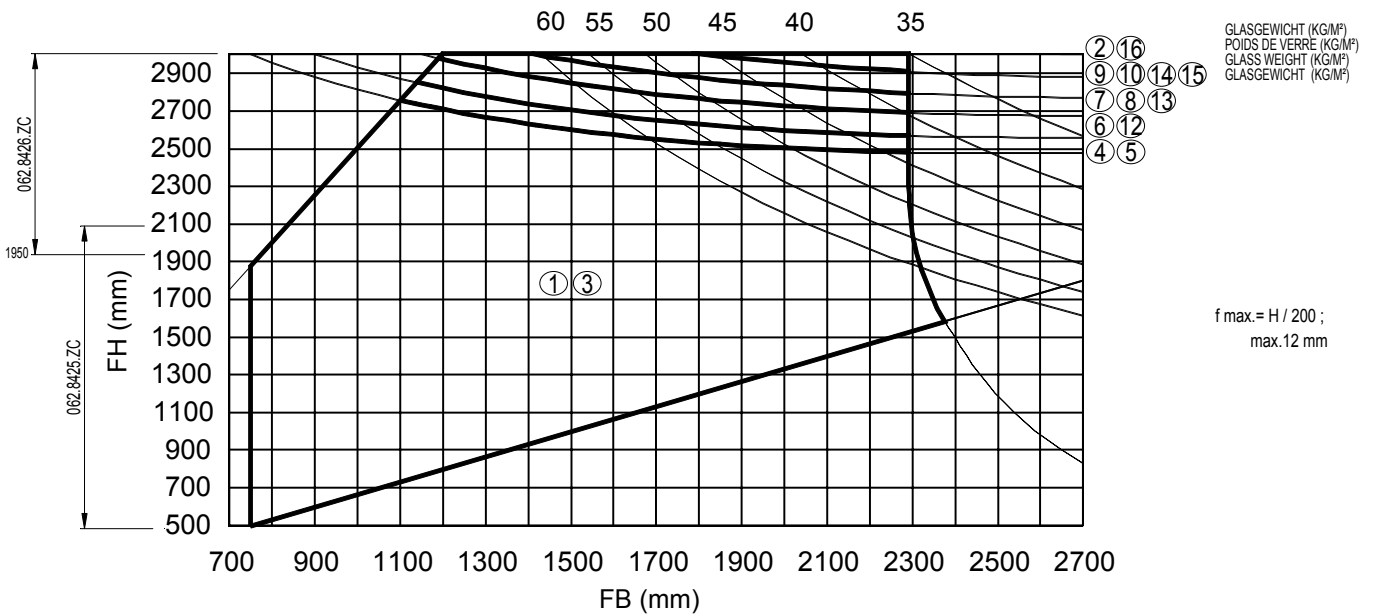
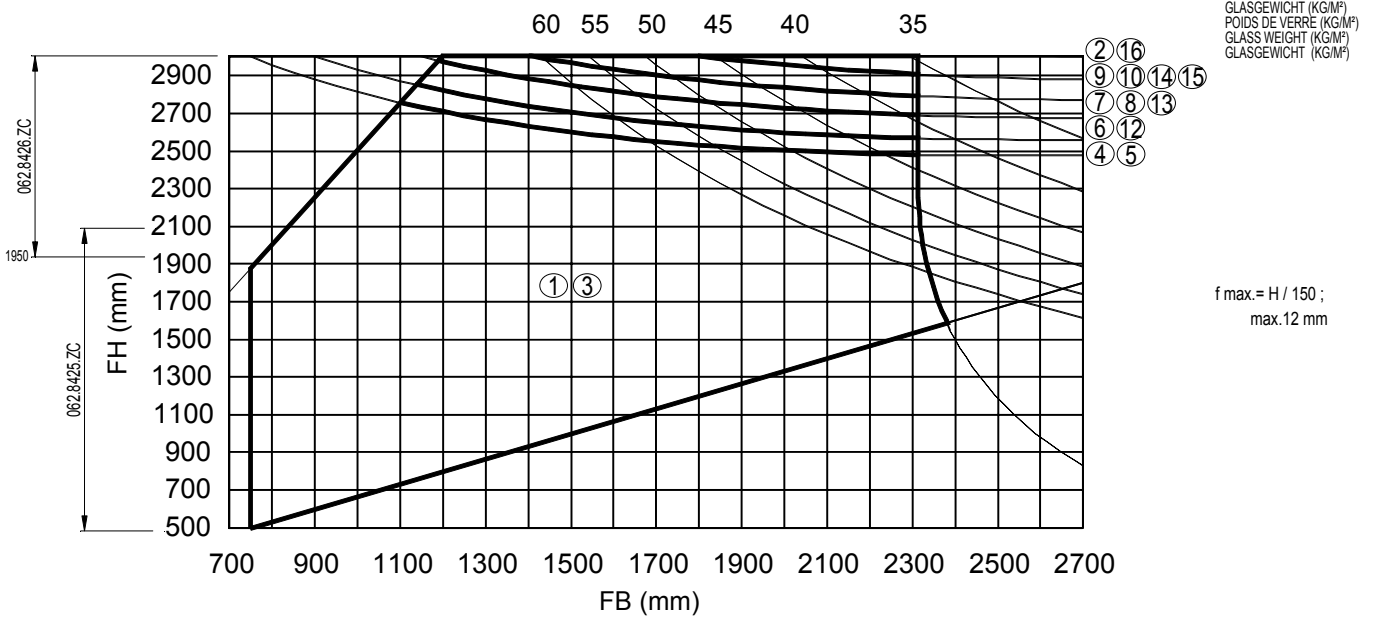

GLASGEWICHT (KG/M²)
 POIDS DE VERRRE (KG/M²)
 GLASS WEIGHT (KG/M²)
 GLASGEWICHT (KG/M²)

$f_{max} = H / 150$;
 max. 12 mm

GLASGEWICHT (KG/M²)
 POIDS DE VERRRE (KG/M²)
 GLASS WEIGHT (KG/M²)
 GLASGEWICHT (KG/M²)

$f_{max} = H / 200$;
 max. 12 mm

GLASGEWICHT (KG/M²)
 POIDS DE VERRRE (KG/M²)
 GLASS WEIGHT (KG/M²)
 GLASGEWICHT (KG/M²)

$f_{max} = H / 300$;
 max. 12 mm

P = 1200Pa
FG max = 300KG

- P = WINDDRUK
- P = PRESSION DU VENT
- P = WINDDRUCK
- P = WIND PRESSURE
- FG = VLEUGELGEWICHT
- FG = POIDS DU VAINTAIL
- FG = FLÜGELGEWICHT
- FG = WEIGHT OF THE VENT
- f = DOORBUIGING
- f = FLEXION
- f = DURCHBIEGUNG
- f = DEFLECTION

D0013993

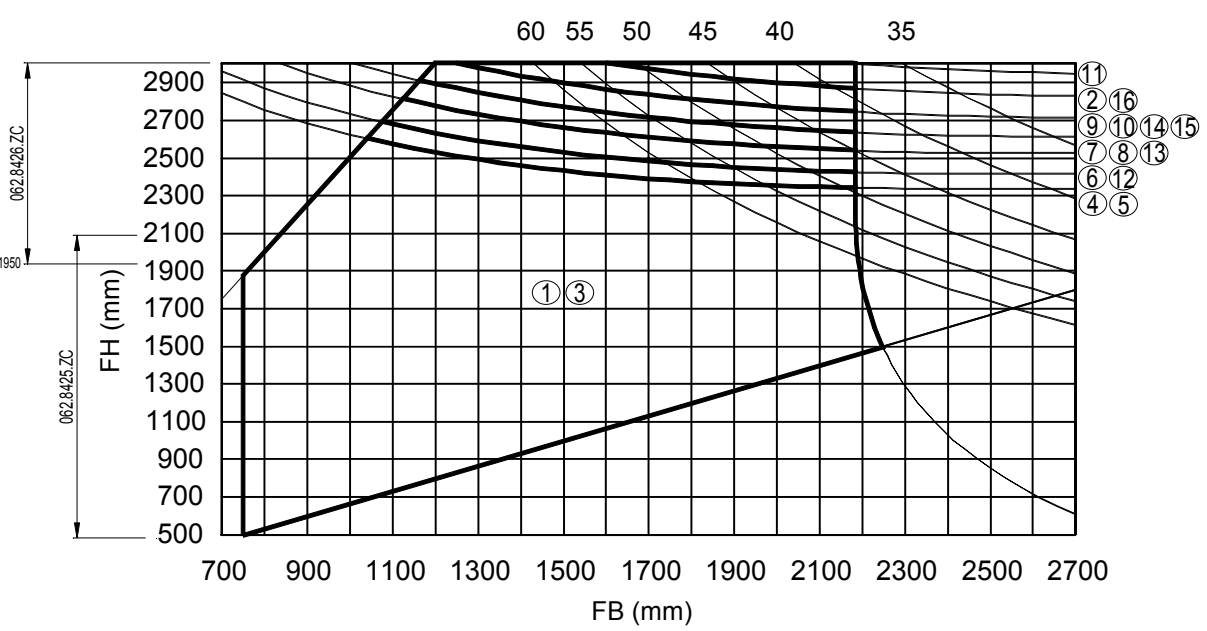

GLASGEWICHT (KG/M²)
 POIDS DE VERRE (KG/M²)
 GLASS WEIGHT (KG/M²)
 GLASGEWICHT (KG/M²)

$f_{max} = H / 150$;
 max. 12 mm

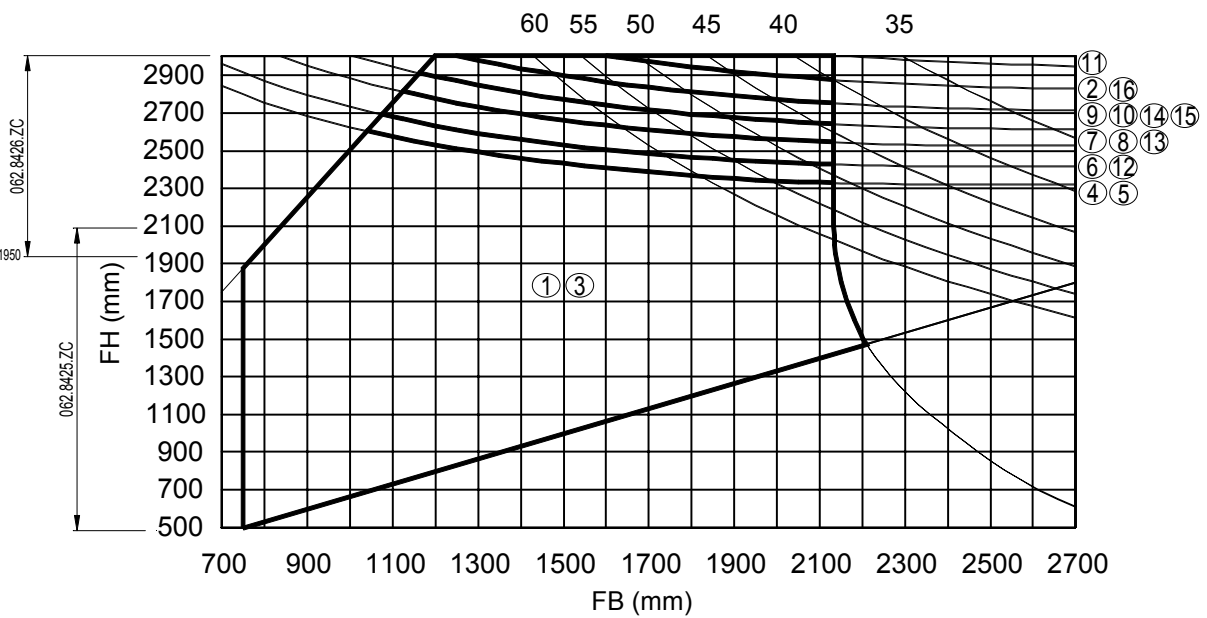

GLASGEWICHT (KG/M²)
 POIDS DE VERRE (KG/M²)
 GLASS WEIGHT (KG/M²)
 GLASGEWICHT (KG/M²)

$f_{max} = H / 200$;
 max. 12 mm

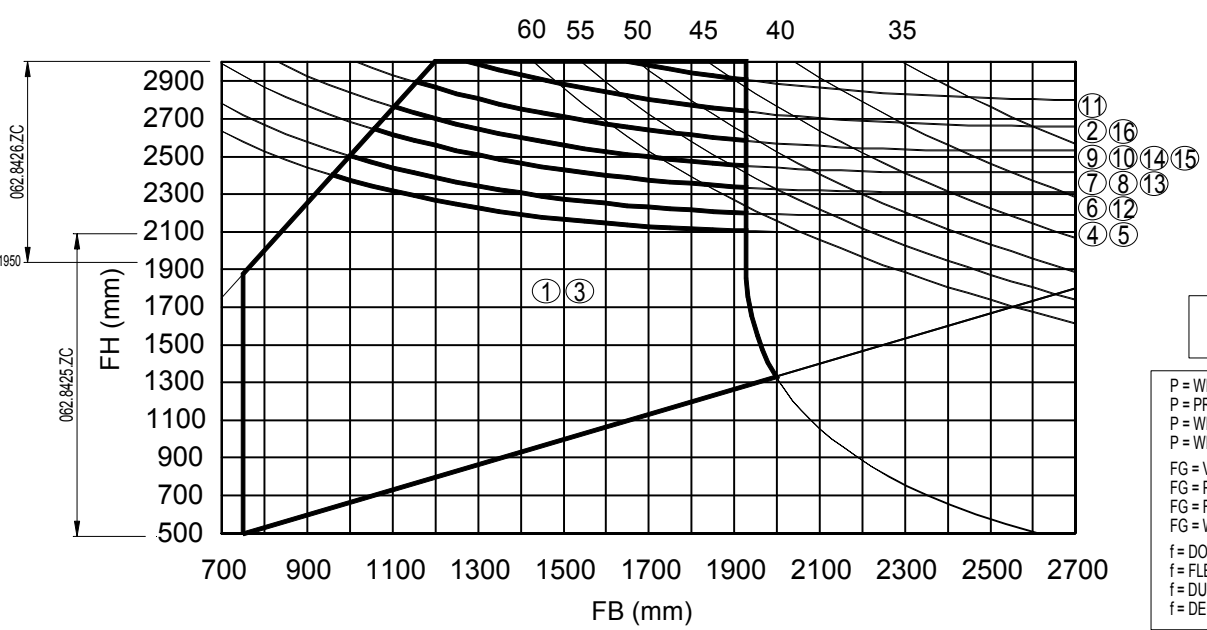

GLASGEWICHT (KG/M²)
 POIDS DE VERRE (KG/M²)
 GLASS WEIGHT (KG/M²)
 GLASGEWICHT (KG/M²)

$f_{max} = H / 300$;
 max. 12 mm

P = 1600Pa
 FG max = 300KG

- P = WINDDRUK
- P = PRESSION DU VENT
- P = WINDDRUCK
- P = WIND PRESSURE
- FG = VLEUGELGEWICHT
- FG = POIDS DU VAINTAIL
- FG = FLÜGELGEWICHT
- FG = WEIGHT OF THE VENT
- f = DOORBUIGING
- f = FLEXION
- f = DURCHBIEGUNG
- f = DEFLECTION

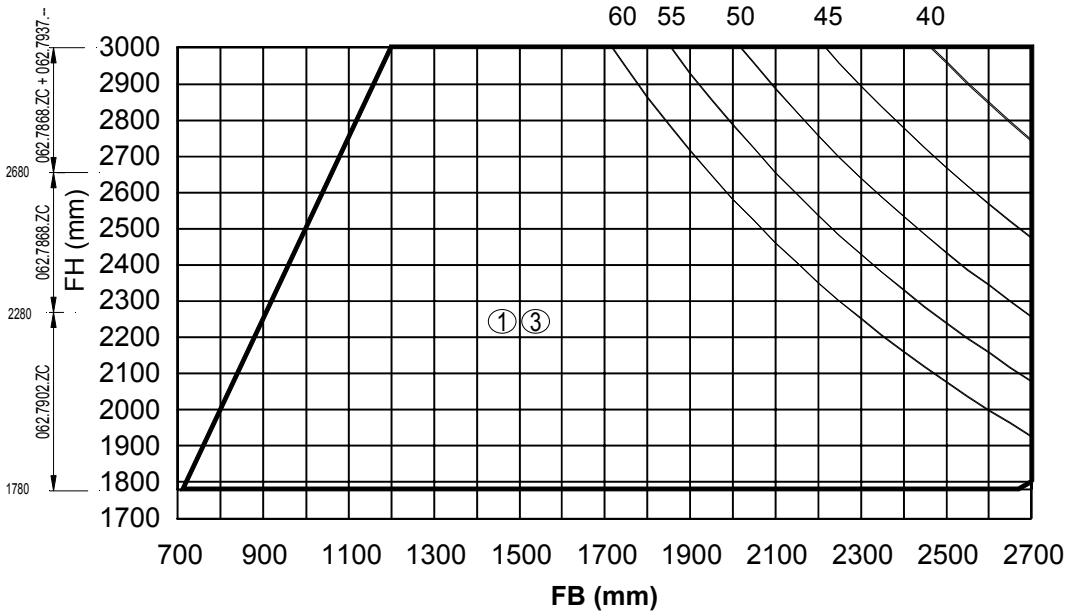

GLASGEWICHT (KG/M²)
 POIDS DE VERRE (KG/M²)
 GLASS WEIGHT (KG/M²)
 GLASGEWICHT (KG/M²)

$f_{max} = H / 150$;
 max. 12 mm

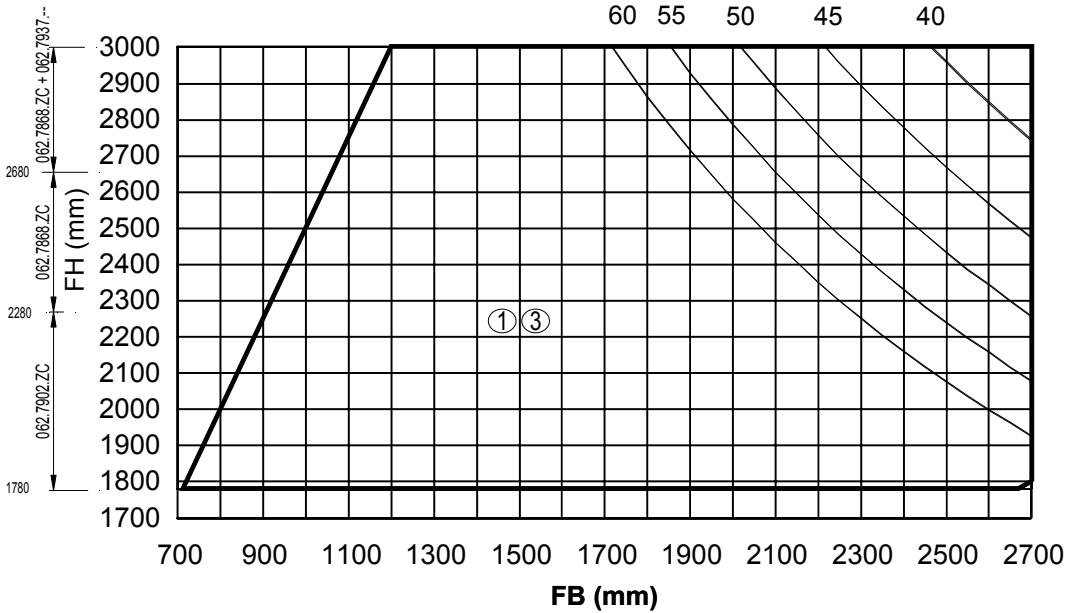

GLASGEWICHT (KG/M²)
 POIDS DE VERRE (KG/M²)
 GLASS WEIGHT (KG/M²)
 GLASGEWICHT (KG/M²)

$f_{max} = H / 200$;
 max. 12 mm

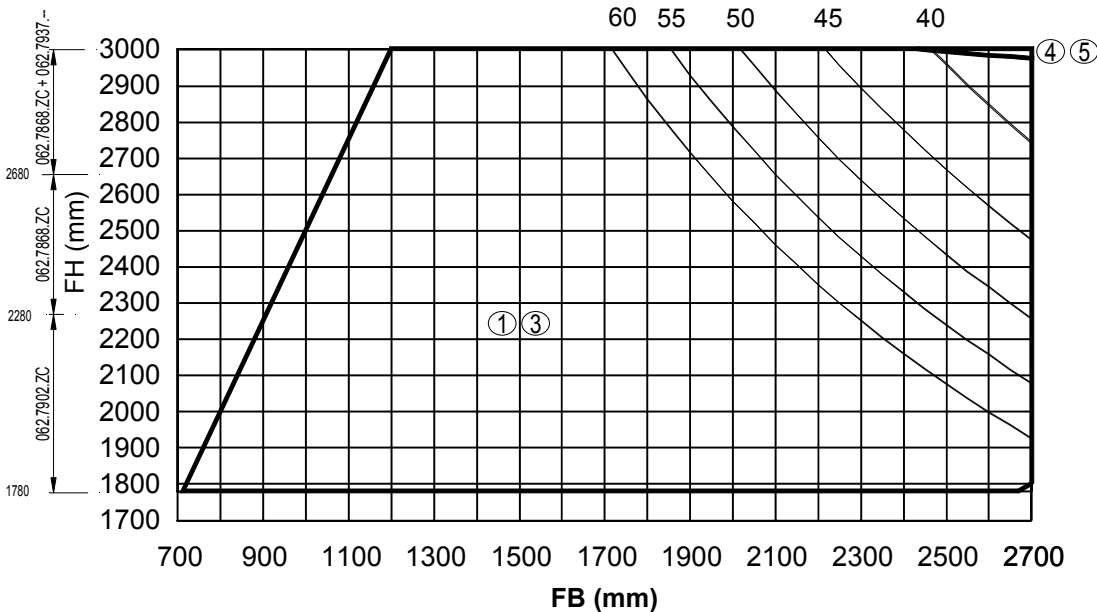

GLASGEWICHT (KG/M²)
 POIDS DE VERRE (KG/M²)
 GLASS WEIGHT (KG/M²)
 GLASGEWICHT (KG/M²)

$f_{max} = H / 300$;
 max. 12 mm

P = 400Pa
 FG max = 300KG
 FG max = 400KG*
 * = ZIE BLZ 34.E. ...
 * = VOIR PAGES 34.E. ...
 * = SEE PAGES 34.E. ...
 * = SIEHE SEITEN 34.E. ...
 * FB MIN = 1500 MM

P = WINDDRUK
 P = PRESSION DU VENT
 P = WINDDRUCK
 P = WIND PRESSURE
 FG = VLEUGELGEWICHT
 FG = POIDS DU VAINTAIL
 FG = FLÜGELGEWICHT
 FG = WEIGHT OF THE VENT
 f = DOORBUIGING
 f = FLEXION
 f = DURCHBIEGUNG
 f = DEFLECTION

D0013995

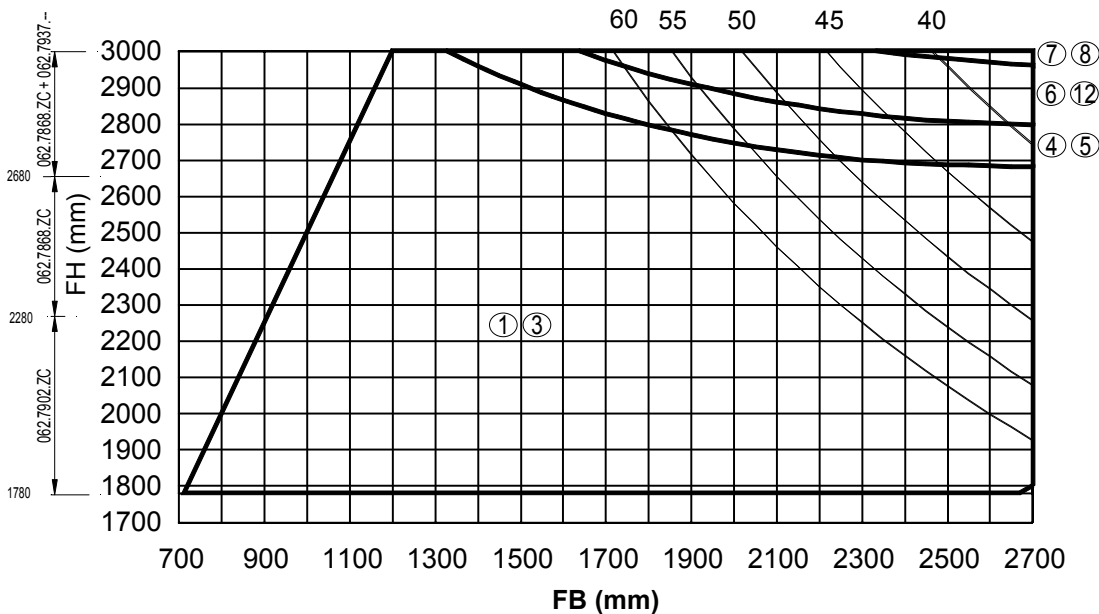
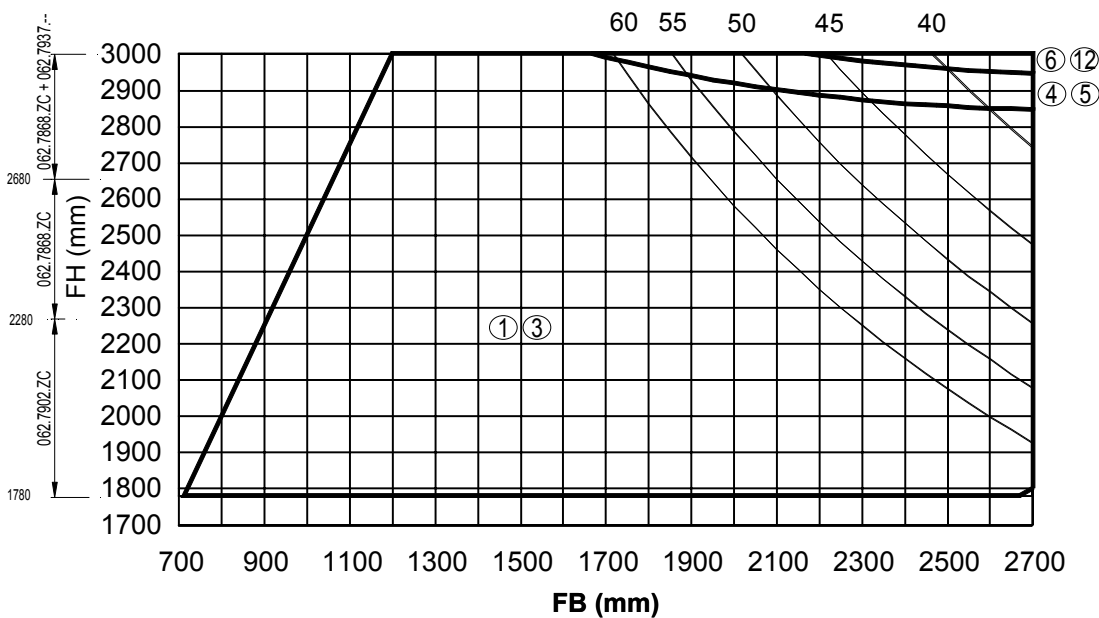
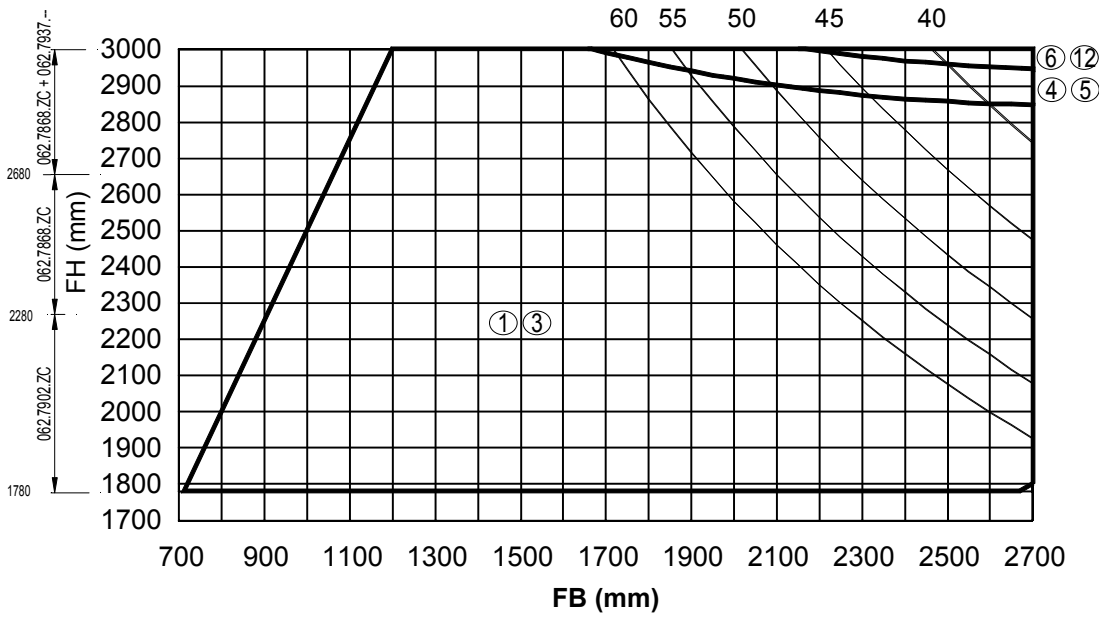

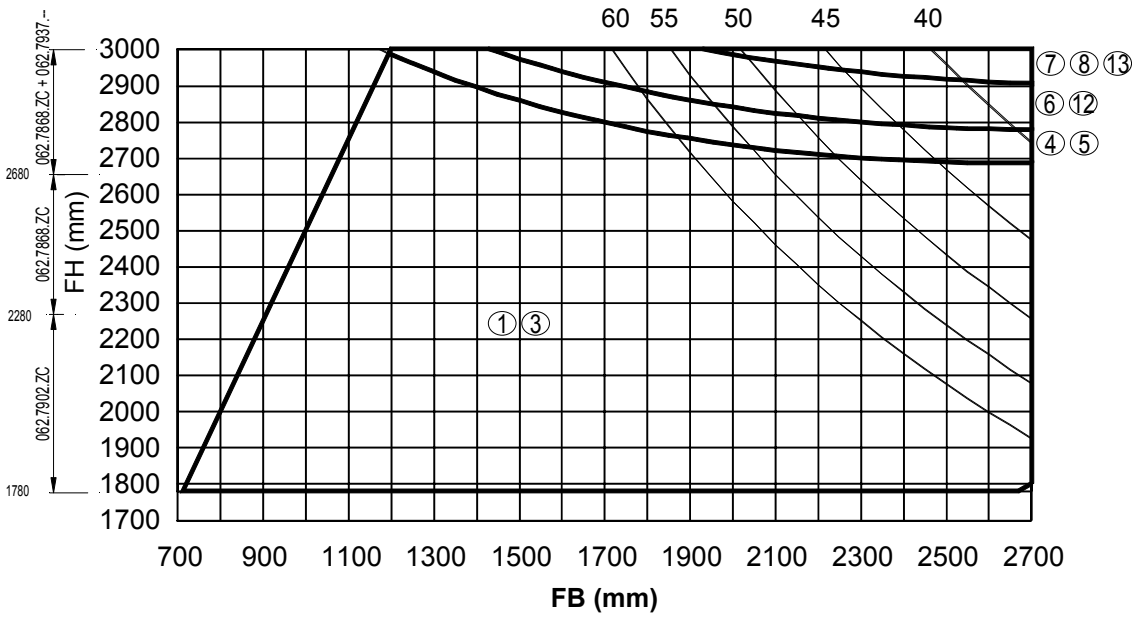

GLASGEWICHT (KG/M²)
 POIDS DE VERRRE (KG/M²)
 GLASS WEIGHT (KG/M²)
 GLASGEWICHT (KG/M²)

f max. = H / 150 ;
 max. 12 mm

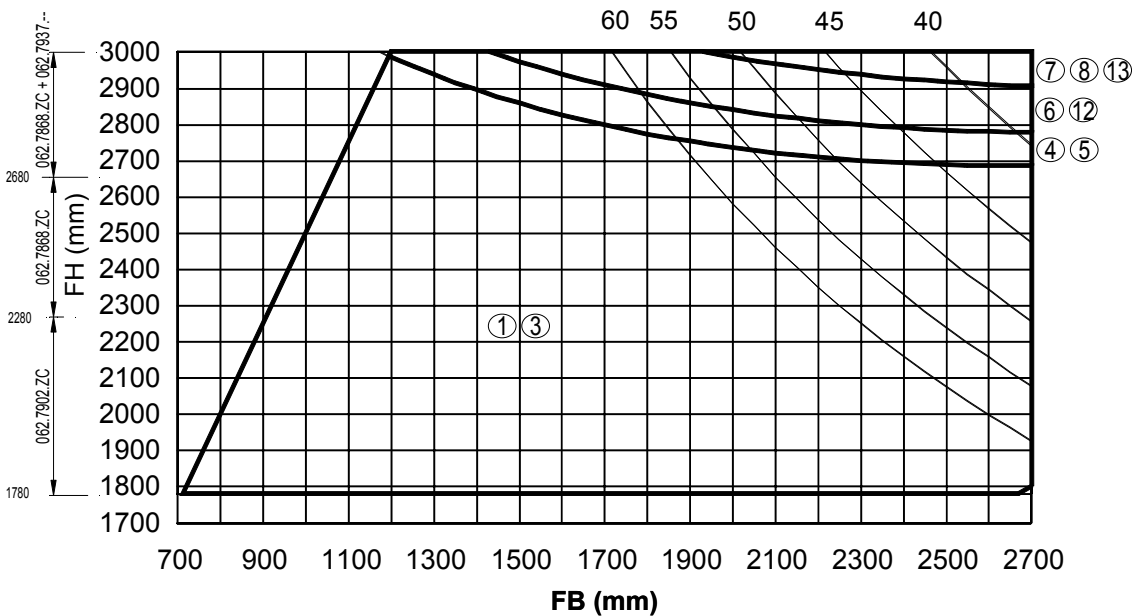

GLASGEWICHT (KG/M²)
 POIDS DE VERRRE (KG/M²)
 GLASS WEIGHT (KG/M²)
 GLASGEWICHT (KG/M²)

f max. = H / 200 ;
 max. 12 mm

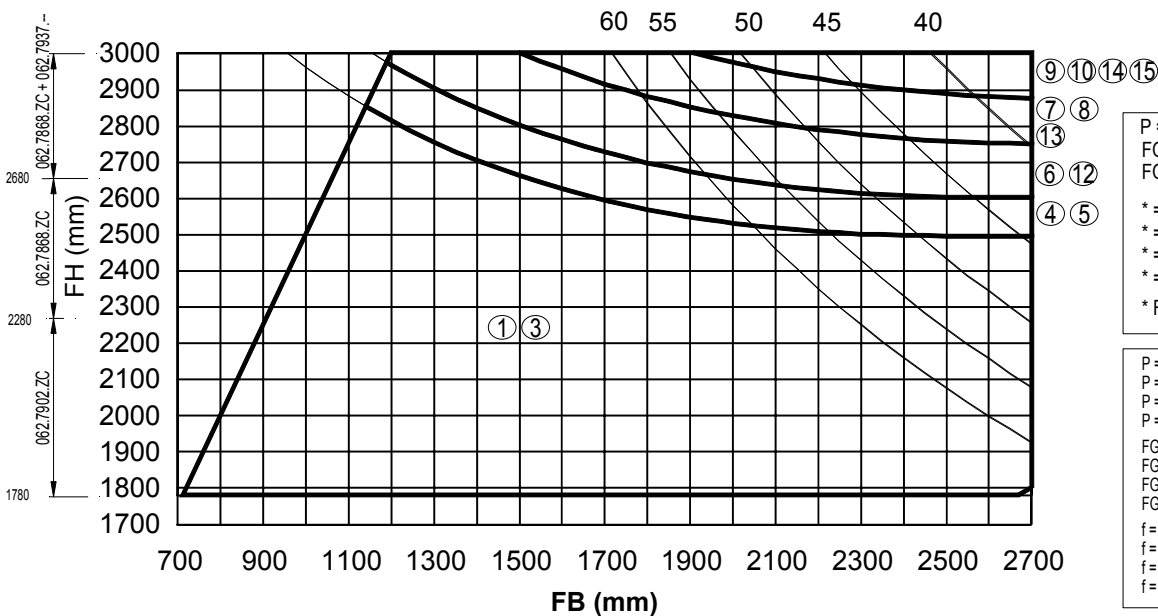

GLASGEWICHT (KG/M²)
 POIDS DE VERRRE (KG/M²)
 GLASS WEIGHT (KG/M²)
 GLASGEWICHT (KG/M²)

f max. = H / 300 ;
 max. 12 mm

P = 800Pa
 FG max = 300KG
 FG max = 400KG*
 * = ZIE BLZ 34.E. ...
 * = VOIR PAGES 34.E. ...
 * = SEE PAGES 34.E. ...
 * = SIEHE SEITEN 34.E. ...
 * FB MIN = 1500 MM

P = WINDDRUK
 P = PRESSION DU VENT
 P = WINDDRUCK
 P = WIND PRESSURE
 FG = VLEUGELGEWICHT
 FG = POIDS DU VAINTAIL
 FG = FLÜGELGEWICHT
 FG = WEIGHT OF THE VENT
 f = DOORBUIGING
 f = FLEXION
 f = DURCHBIEGUNG
 f = DEFLECTION

D0013997

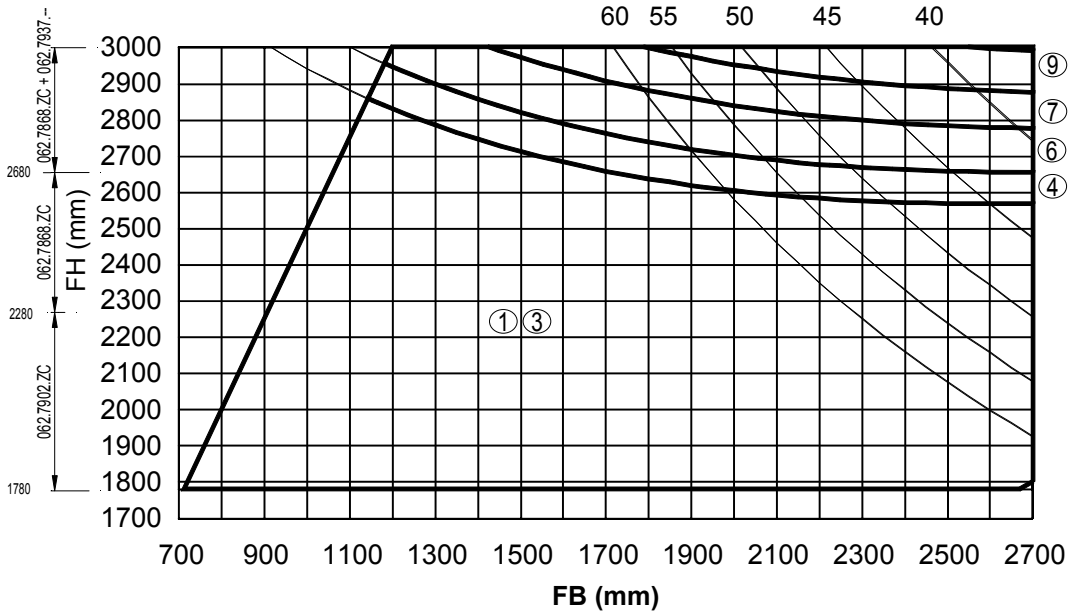

GLASGEWICHT (KG/M²)
 POIDS DE VERRE (KG/M²)
 GLASS WEIGHT (KG/M²)
 GLASGEWICHT (KG/M²)

f max = H / 150 ;
 max. 12 mm

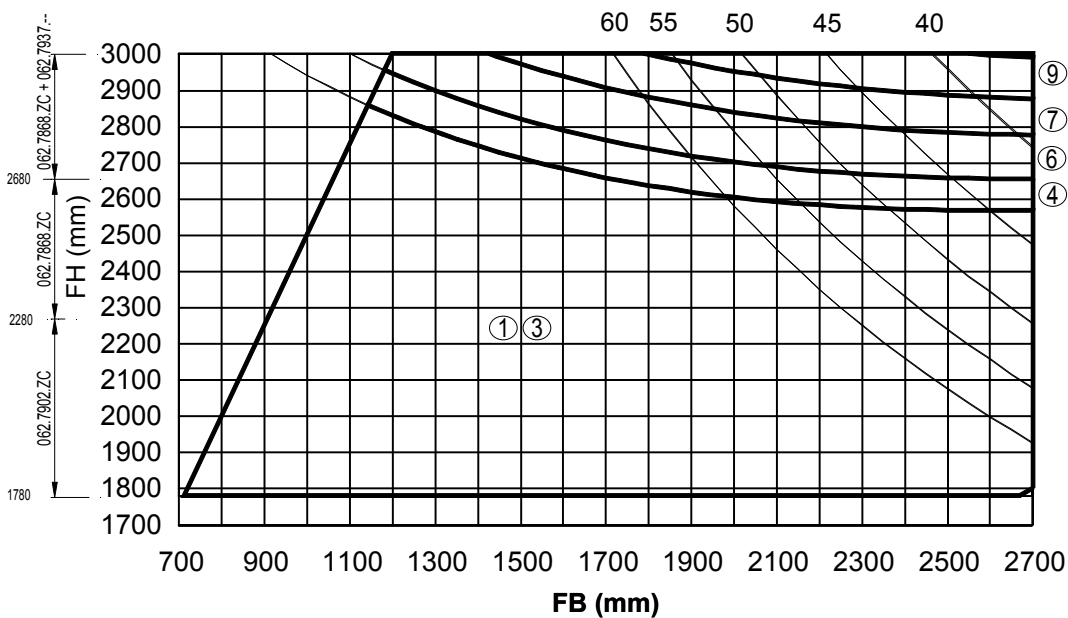

GLASGEWICHT (KG/M²)
 POIDS DE VERRE (KG/M²)
 GLASS WEIGHT (KG/M²)
 GLASGEWICHT (KG/M²)

f max = H / 200 ;
 max. 12 mm

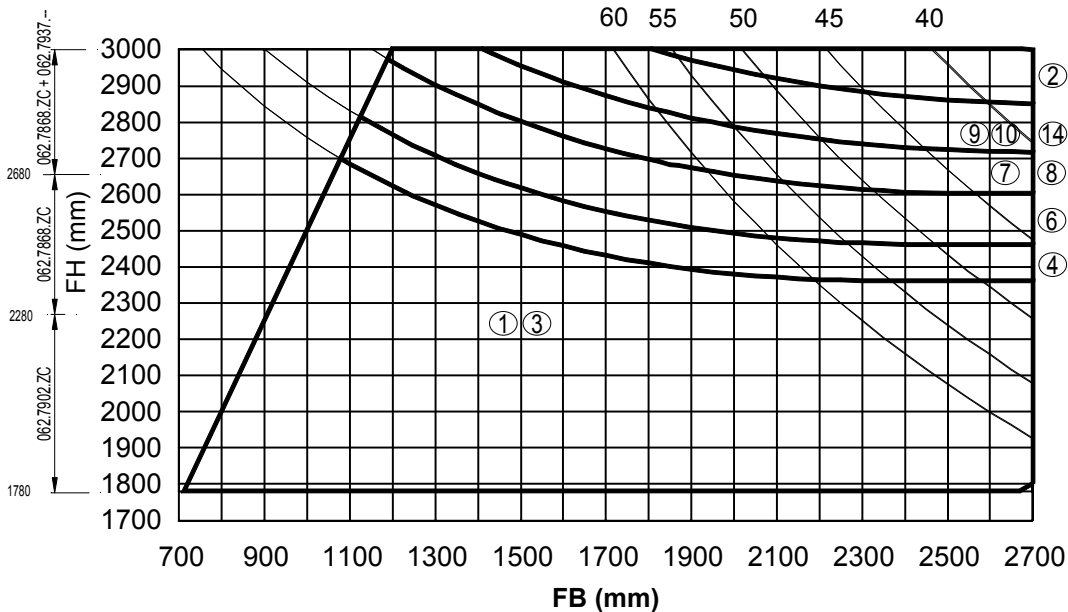

GLASGEWICHT (KG/M²)
 POIDS DE VERRE (KG/M²)
 GLASS WEIGHT (KG/M²)
 GLASGEWICHT (KG/M²)

f max = H / 300 ;
 max. 12 mm

P = 1000Pa
 FG max = 300KG
 FG max = 400KG*
 * = ZIE BLZ 34.E. ...
 * = VOIR PAGES 34.E. ...
 * = SEE PAGES 34.E. ...
 * = SIEHE SEITEN 34.E. ...
 * FB MIN = 1500 MM

P = WINDDRUK
 P = PRESSION DU VENT
 P = WINDRUCK
 P = WIND PRESSURE
 FG = VLEUGELGEWICHT
 FG = POIDS DU VAINTAIL
 FG = FLÜGELGEWICHT
 FG = WEIGHT OF THE VENT
 f = DOORBUIGING
 f = FLEXION
 f = DURCHBIEGUNG
 f = DEFLECTION

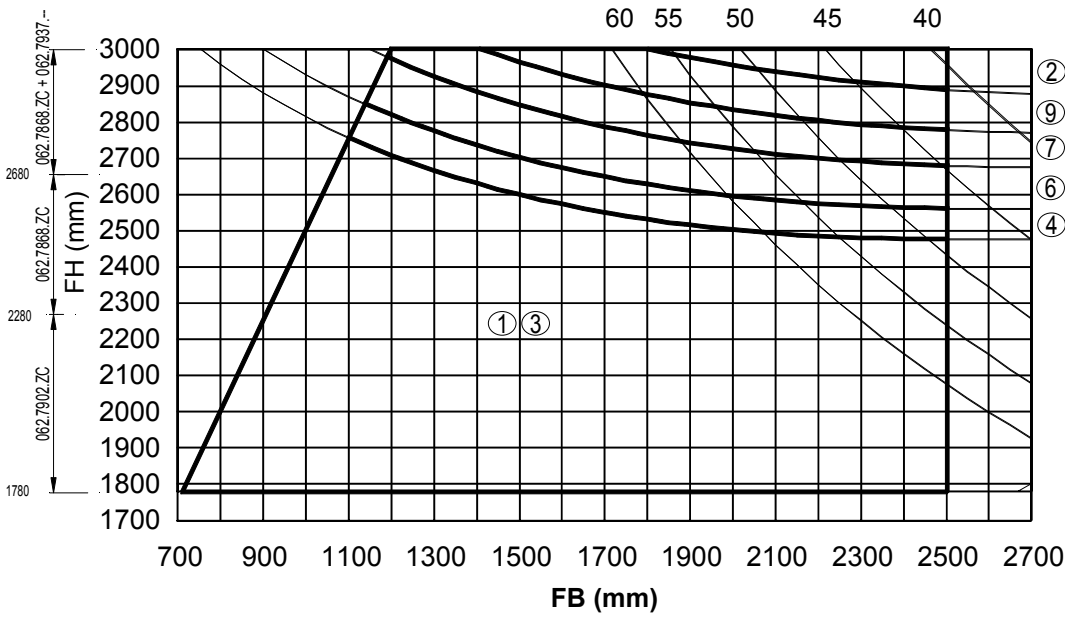

GLASGEWICHT (KG/M²)
 POIDS DE VERRRE (KG/M²)
 GLASS WEIGHT (KG/M²)
 GLASGEWICHT (KG/M²)

$f_{max} = H / 150$;
 max. 12 mm

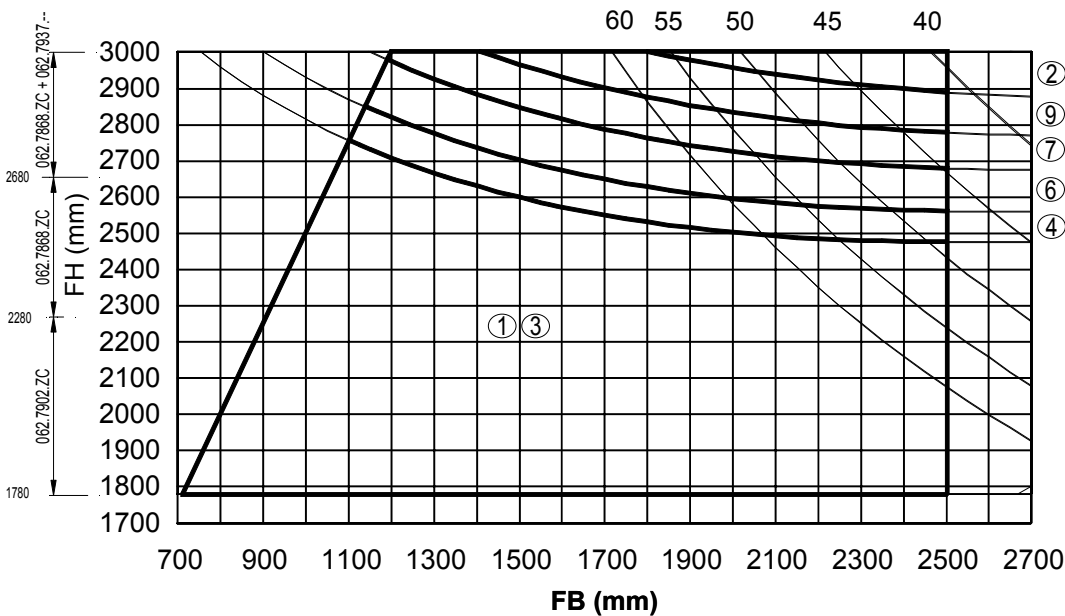

GLASGEWICHT (KG/M²)
 POIDS DE VERRRE (KG/M²)
 GLASS WEIGHT (KG/M²)
 GLASGEWICHT (KG/M²)

$f_{max} = H / 200$;
 max. 12 mm

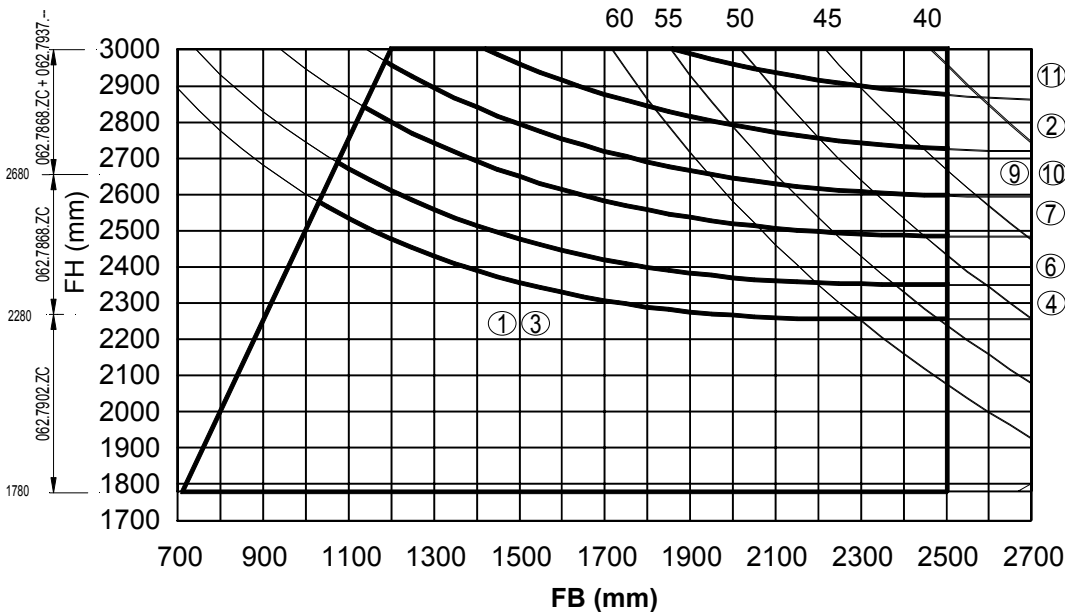

GLASGEWICHT (KG/M²)
 POIDS DE VERRRE (KG/M²)
 GLASS WEIGHT (KG/M²)
 GLASGEWICHT (KG/M²)

$f_{max} = H / 300$;
 max. 12 mm

P = 1200Pa
 FG max = 300KG
 FG max = 400KG*

* = ZIE BLZ 34.E. ...
 * = VOIR PAGES 34.E. ...
 * = SEE PAGES 34.E. ...
 * = SIEHE SEITEN 34.E. ...
 * FB MIN = 1500 MM

P = WINDDRUK
 P = PRESSION DU VENT
 P = WINDRUCK
 P = WIND PRESSURE

FG = VLEUGELGEWICHT
 FG = POIDS DU VAINTAIL
 FG = FLÜGELGEWICHT
 FG = WEIGHT OF THE VENT

f = DOORBUIGING
 f = FLEXION
 f = DURCHBIEGUNG
 f = DEFLECTION

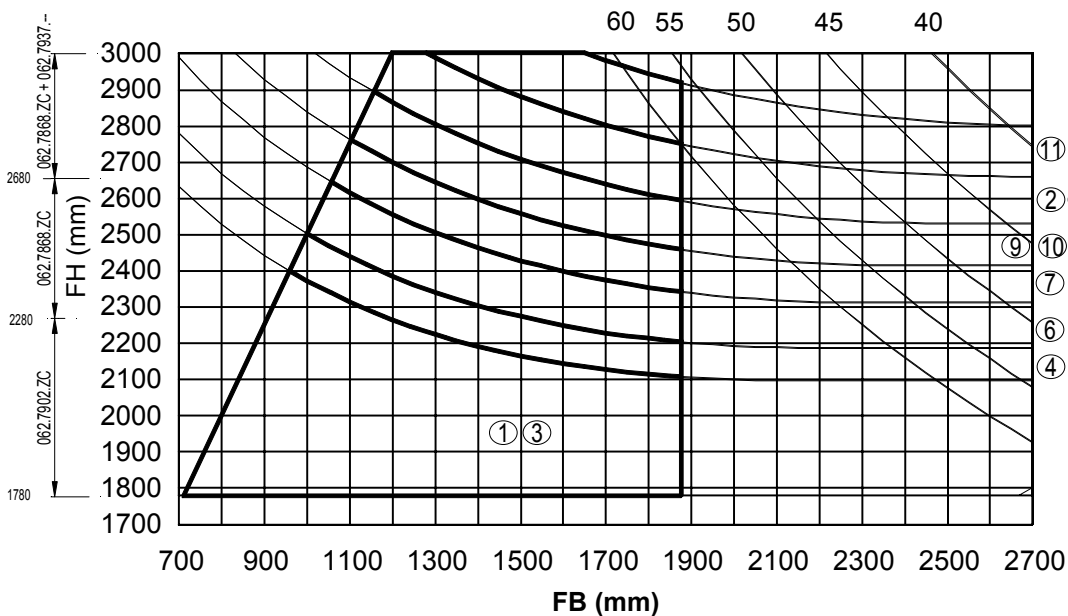
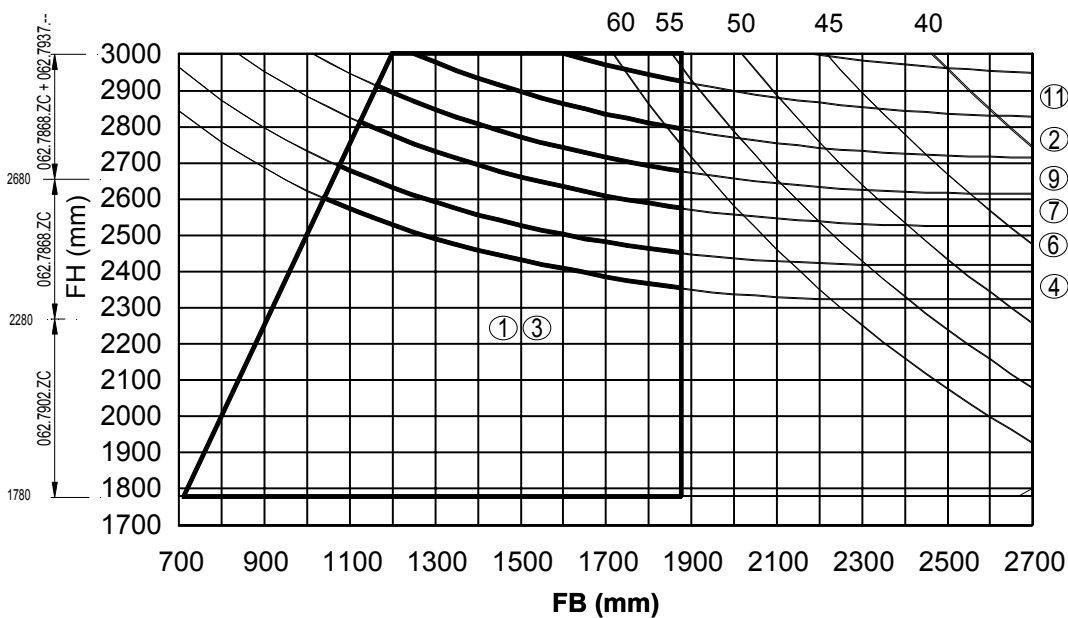
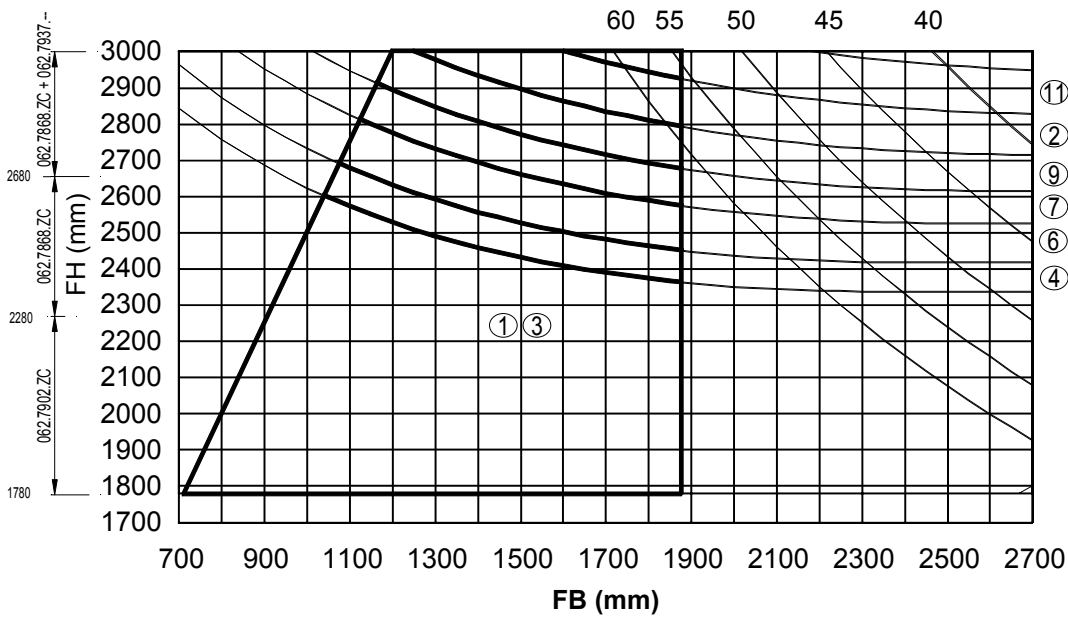

P = 1600Pa
 FG max = 300KG
 FG max = 400KG*

* = ZIE BLZ 34.E. ...
 * = VOIR PAGES 34.E. ...
 * = SEE PAGES 34.E. ...
 * = SIEHE SEITEN 34.E. ...
 * FB MIN = 1500 MM

P = WINDDRUK
 P = PRESSION DU VENT
 P = WINDRUCK
 P = WIND PRESSURE

FG = VLEUGELGEWICHT
 FG = POIDS DU VANTAIL
 FG = FLÜGELGEWICHT
 FG = WEIGHT OF THE VENT

f = DOORBUIGING
 f = FLEXION
 f = DURCHBIEGUNG
 f = DEFLECTION

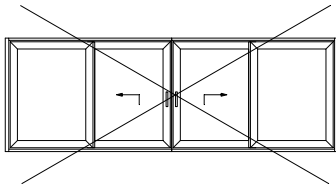

automatische schuifdeur enkel toepasbaar voor 2-rail (XQ), niet voor 4-rail
 prote coulissante automatique seulement applicable pour 2-rail, pas pour 4-rail
 automatic sliding door only for 2-rail, not for 4-rail
 automatische Schiebetuer nur für 2-rail, nicht für 4-rail

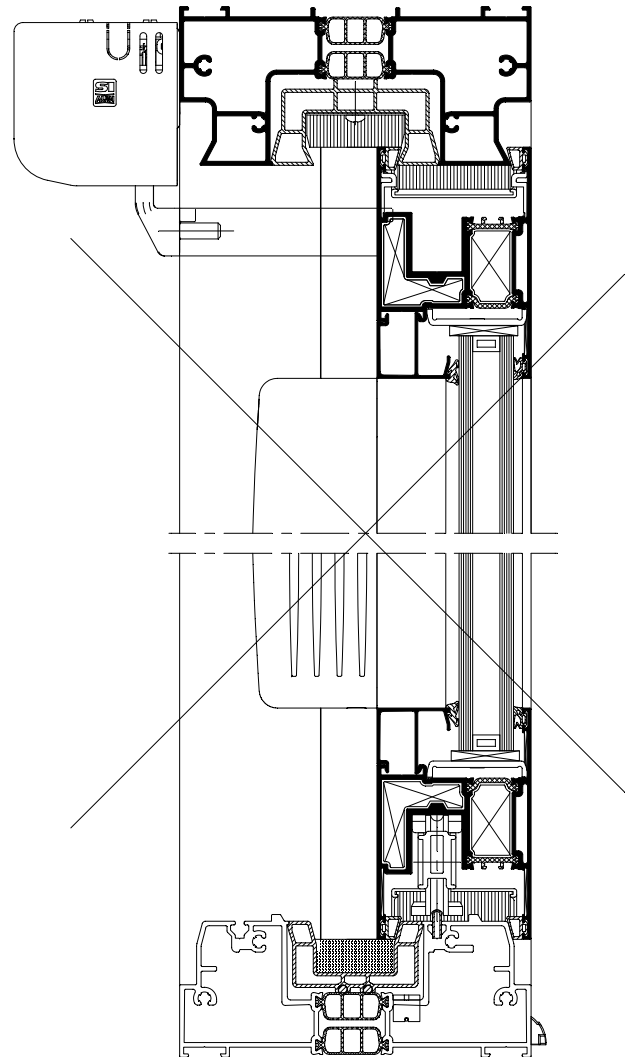
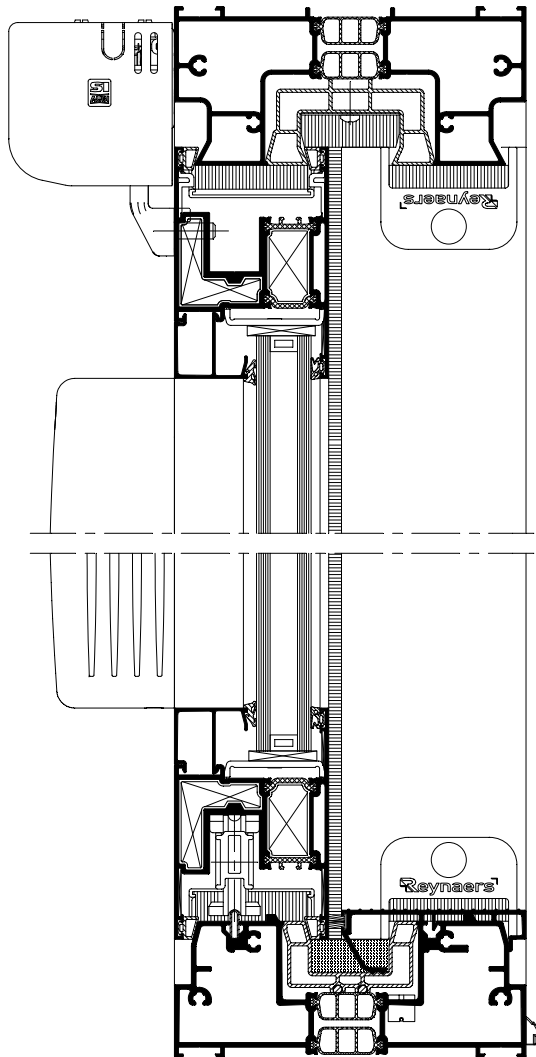

Automatic Lift and Sliding door accessories for CP 155-LS

(Please fill out in clear writing) and Fax to: +32 15 308 600

Order done for Reynaers ...

(e.g. BeLux, Germany, ...)

Client details:

- Name:
- Street:
- Town:
- Telephone nr.:
- Contact person:.....
- Fax:.....
- eMail:.....
- Alternative delivery adres:.....
- Repsonsible person for this region:.....
- Specific regulations:.....
- Amount of Lift and Slide doors (with the same dimensions):.....

Technical details for type XQ (or scheme A) solution

- Vent height:MM
- Vent width:MM
- Size A (RIB), base profile motor:MM (Between 775 and 6666MM)
For CP 155-LS, Size A = B-120MM

- Vent weight:kg

Type of XQ (or Scheme A) solution

- DIN left: Yes/No
- DIN right: Yes/No

General remarks

- One remote control is delivered as standard.
- Please consult System catalogue for min and max system dimensions.

SCP → SEND FORM to SIEGENIA-AUBI

Order number Siegenia-Aubi :

NIET BEHEERD KOPIJ

G





Toebehoren

Accessoires

Accessories

Zubehör





Art. N°			Art. N°		
050.5091.--	34.G.021	D0090453	062.8027.04	34.G.058	D0014040
050.5153.--	34.G.020	D0079657	062.8036.04	34.G.057	D0014039
056.6209.04	34.G.047	D0014035	062.8037.04	34.G.057	D0014039
056.6270.--	34.G.063	D0090239	062.8038.07	34.G.047	D0014035
056.6273.--	34.G.063	D0090239	062.8039.07	34.G.047	D0014035
056.6297.00	34.G.062	D0014042	062.8045.04	34.G.046	D0014034
056.6298.01	34.G.062	D0014042	062.8424.XX	34.G.032	D0014022
056.6299.--	34.G.062	D0014042	062.8425.ZC	34.G.034	D0014023
056.6301.--	34.G.062	D0014042	062.8426.ZC	34.G.034	D0014023
060.8723.--	34.G.012	D0014007	062.8431.PA	34.G.031	D0090576
060.8746.00	34.G.012	D0014007	062.8432.PA	34.G.031	D0090576
061.6992.PA	34.G.025	D0084604	062.8433.--	34.G.031	D0090576
061.7038.--	34.G.036	D0014025	062.8434.--	34.G.035	D0014024
061.7044.--	34.G.036	D0014025	062.8438.--	34.G.035	D0014024
061.7098.--	34.G.029	D0079664	062.8440.XX	34.G.035	D0014024
061.7130.PA	34.G.022	D0014019	062.8441.XX	34.G.035	D0014024
061.7131.PA	34.G.022	D0014019	062.9372.04	34.G.013	D0045257
061.7132.PA	34.G.022	D0014019	062.9375.04	34.G.013	D0045257
061.7133.PA	34.G.023	D0084602	062.9392.04	34.G.059	D0079746
061.7134.PA	34.G.023	D0084602	062.9393.04	34.G.059	D0079746
061.7135.PA	34.G.023	D0084602	062.9396.04	34.G.059	D0079746
061.7140.PA	34.G.024	D0084603	062.9397.04	34.G.059	D0079746
061.7141.PA	34.G.024	D0084603	062.9399.04	34.G.059	D0079746
061.7142.PA	34.G.024	D0084603	065.6555.04	34.G.044	D0014032
061.7143.PA	34.G.025	D0084604	068.5920.--	34.G.020	D0079657
061.7144.PA	34.G.025	D0084604	068.5932.--	34.G.089	D0075642
061.7145.PA	34.G.025	D0084604	068.6351.04	34.G.045	D0014033
062.6744.04	34.G.043	D0014031	068.7555.00	34.G.008	D0014004
062.6787.SY	34.G.090	D0059648	068.7558.00	34.G.008	D0014004
062.6788.SY	34.G.090	D0059648	068.7633.00	34.G.008	D0014004
062.6789.SY	34.G.090	D0059648	068.7775.00	34.G.008	D0014004
062.6790.SY	34.G.090	D0059648	068.7776.00	34.G.011	D0084683
062.6791.SY	34.G.090	D0059648	068.8574.00	34.G.009	D0014005
062.6792.SY	34.G.091	D0059652	068.8576.00	34.G.009	D0014005
062.6793.XX	34.G.091	D0059652	068.8682.04	34.G.019	D0014013
062.6857.04	34.G.045	D0014033	068.8687.04	34.G.019	D0014013
062.6940.--	34.G.037	D0014026	068.8730.00	34.G.014	D0014008
062.7715.XX	34.G.043	D0014031	068.8731.00	34.G.014	D0014008
062.7717.04	34.G.043	D0014031	068.8732.00	34.G.015	D0014009
062.7718.04	34.G.043	D0014031	068.8733.00	34.G.015	D0014009
062.7750.PA	34.G.030	D0014020	068.8734.00	34.G.016	D0014010
062.7752.PA	34.G.030	D0014020	068.8740.00	34.G.017	D0090450
062.7800.04	34.G.041	D0014029	068.8741.00	34.G.017	D0090450
062.7834.--	34.G.042	D0014030	068.8742.00	34.G.018	D0090451
062.7861.XX	34.G.026	D0014017	068.8743.00	34.G.018	D0090451
062.7862.XX	34.G.026	D0014017	068.8779.00	34.G.021	D0090453
062.7863.PA	34.G.027	D0014018	068.8835.00	34.G.009	D0014005
062.7864.PA	34.G.027	D0014018	069.6569.04	34.G.010	D0014006
062.7865.XX	34.G.026	D0014017	069.6575.04	34.G.010	D0014006
062.7867.--	34.G.038	D0014027	069.6747.04	34.G.044	D0014032
062.7868.ZC	34.G.039	D0014028	069.6761.04	34.G.045	D0014033
062.7869.--	34.G.037	D0014026	069.6830.04	34.G.044	D0014032
062.7871.--	34.G.037	D0014026	069.8422.04	34.G.044	D0014032
062.7872.PA	34.G.026	D0014017	069.8724.04	34.G.041	D0014029
062.7894.04	34.G.046	D0014034	071.6554.SY	34.G.046	D0014034
062.7902.ZC	34.G.039	D0014028	080.9114.SY	34.G.051	D0045280
062.7903.--	34.G.038	D0014027	080.9116.04	34.G.051	D0045280
062.7927.04	34.G.046	D0014034	080.9118.04	34.G.051	D0045280
062.7937.--	34.G.040	D0075261	080.9120.04	34.G.052	D0090489
062.7952.PA	34.G.027	D0014018	080.9123.SY	34.G.048	D0014036
062.7953.PA	34.G.027	D0014018	080.9124.SY	34.G.048	D0014036
062.7961.ZC	34.G.033	D0075082	080.9125.SY	34.G.049	D0090480
062.7962.ZC	34.G.033	D0075082	080.9126.SY	34.G.049	D0090480
062.7963.XX	34.G.028	D0075081	080.9128.04	34.G.050	D0014037
062.7964.XX	34.G.028	D0075081	080.9130.04	34.G.050	D0014037
062.7965.XX	34.G.028	D0075081	080.9253.04	34.G.053	D0014038
062.8011.04	34.G.057	D0014039	080.9381.04	34.G.053	D0014038
062.8012.04	34.G.057	D0014039	080.9424.04	34.G.053	D0014038
062.8013.07	34.G.057	D0014039	080.9430.04	34.G.054	D0090492
062.8025.04	34.G.058	D0014040	080.9439.04	34.G.055	D0045283

CP 155 CP 155-LS

TOEBEHORENLIJST
LISTE DES ACCESSOIRES
LIST OF ACCESSORIES
LISTE VON ZUBEHOER



Art. N°			Art. N°		
080.9441.04	34.G.054	D0090492			
080.9625.07	34.G.055	D0045283			
080.9629.07	34.G.056	D0090238			
080.9630.07	34.G.056	D0090238			
080.9815.SY	34.G.055	D0045283			
081.9091.04	34.G.060	D0014041			
081.9092.04	34.G.060	D0014041			
081.9241.07	34.G.060	D0014041			
082.5401.--	34.G.089_01.001	D0091336			
084.9041.04	34.G.071	D0084678			
084.9051.04	34.G.071	D0084678			
084.9080.--	34.G.064	D0014043			
084.9080.--	34.G.070	D0014049			
084.9085.--	34.G.070	D0014049			
084.9090.--	34.G.073	D0084680			
084.9103.04	34.G.064	D0014043			
084.9106.--	34.G.064	D0014043			
084.9111.--	34.G.065	D0014044			
084.9113.--	34.G.065	D0014044			
084.9140.--	34.G.073	D0084680			
084.9410.01	34.G.061	D0084719			
084.9411.01	34.G.061	D0084719			
084.9414.07	34.G.072	D0084679			
084.9420.07	34.G.072	D0084679			
084.9426.04	34.G.074	D0084681			
084.9480.--	34.G.066	D0014045			
084.9550.01	34.G.065	D0014044			
084.9580.01	34.G.066	D0014045			
084.9750.01	34.G.066	D0014045			
086.9150.--	34.G.066	D0014045			
086.9160.--	34.G.067	D0014046			
086.9175.--	34.G.067	D0014046			
086.9208.SY	34.G.068	D0014047			
086.9210.--	34.G.067	D0014046			
086.9211.--	34.G.068	D0014047			
086.9213.--	34.G.067	D0014046			
086.9225.--	34.G.068	D0014047			
086.9551.--	34.G.068	D0014047			
086.9600.XX	34.G.069	D0014048			

Art. N°			Art. N°		
086.9191.--	34.G.092	D0014058			
095.A730.00	34.G.105	D0046335			
095.B323.00	34.G.106	D0079756			
095.B532.00	34.G.110	D0046323			
095.B533.00	34.G.110	D0046323			
095.B533.00	34.G.111	D0046324			
095.B534.00	34.G.111	D0046324			
095.B561.00	34.G.112	D0046322			
095.B562.00	34.G.112	D0046322			
095.B565.00	34.G.113	D0046328			
095.H810.00	34.G.107	D0046333			
095.H850.00	34.G.109	D0046330			
095.H853.00	34.G.109	D0046330			
095.H856.00	34.G.109	D0046330			
095.I000.--	34.G.114	D0084682			
095.J200.00	34.G.114	D0084682			
097.0009.00	34.G.093	D0014059			
097.0010.00	34.G.094	D0014061			
097.0014.00	34.G.096	D0079753			
097.0047.00	34.G.095	D0014062			
097.0296.00	34.G.097	D0059656			
097.0410.00	34.G.094	D0014061			
097.0437.00	34.G.095	D0014062			
097.0440.00	34.G.098	D0014063			
097.0441.00	34.G.098	D0014063			
097.0683.07	34.G.097	D0059656			
097.0698.00	34.G.096	D0079753			
097.0754.00	34.G.115	D0090231			
097.A200.00	34.G.108	D0046332			
097.C000.00	34.G.108	D0046332			
097.D300.00	34.G.108	D0046332			
097.E900.00	34.G.108	D0046332			
097.L700.00	34.G.104	D0090229			
097.O900.00	34.G.099	D0074794			
097.P000.00	34.G.099	D0074794			
097.P900.00	34.G.102	D0084692			
097.U300.00	34.G.103	D0075005			
097.U400.00	34.G.103	D0075005			
097.X000.00	34.G.100	D0074792			
097.X100.00	34.G.100	D0074792			
097.X300.00	34.G.101	D0074793			

CP 155
CP 155-LS

MACHINELIJST
LISTE DES MACHINES
LIST OF MACHINERY
LISTE VON MASCHINEN



CP 155 CP 155-LS

OVERZICHT
APERCU
OVERVIEW
UEBERSICHT



050.5091.-- (34.G.021)	050.5153.-- (34.G.020)	056.6209.04 (34.G.047)	056.6270.-- (34.G.063)	056.6273.-- (34.G.063)
056.6297.00 (34.G.062)	056.6298.01 (34.G.062)	056.6299.-- (34.G.062)	056.6301.-- (34.G.062)	060.8723.-- (34.G.012)
060.8746.00 (34.G.012)	061.6992.PA (34.G.025)	061.7038.-- (34.G.036)	061.7044.-- (34.G.036)	061.7098.-- (34.G.029)
061.7130.PA (34.G.022)	061.7131.PA (34.G.022)	061.7132.PA (34.G.022)	061.7133.PA (34.G.023)	061.7134.PA (34.G.023)
061.7135.PA (34.G.023)	061.7140.PA (34.G.024)	061.7141.PA (34.G.024)	061.7142.PA (34.G.024)	061.7143.PA (34.G.025)
061.7144.PA (34.G.025)	061.7145.PA (34.G.025)	062.6744.04 (34.G.043)	062.6787.SY (34.G.090)	062.6788.SY (34.G.090)
062.6789.SY (34.G.090)	062.6790.SY (34.G.090)	062.6791.SY (34.G.090)	062.6792.SY (34.G.091)	062.6793.PA (34.G.091)

CP 155 CP 155-LS

OVERZICHT
APERCU
OVERVIEW
UEBERSICHT











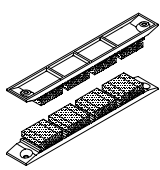
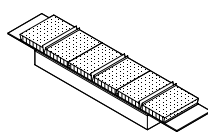
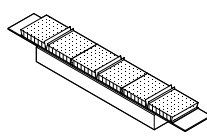
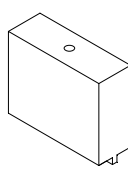
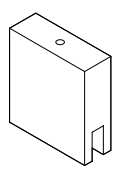

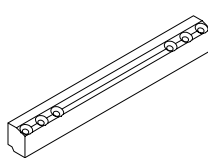

062.6857.04 (34.G.045)	062.6940.-- (34.G.037)	062.7715.XX (34.G.043)	062.7717.04 (34.G.043)	062.7718.04 (34.G.043)
062.7750.PA (34.G.030)	062.7752.PA (34.G.030)	062.7800.04 (34.G.041)	062.7834.-- (34.G.042)	062.7861.PA (34.G.026)
062.7862.PA (34.G.026)	062.7863.PA (34.G.027)	062.7864.PA (34.G.027)	062.7865.PA (34.G.026)	062.7867.-- (34.G.038)
062.7868.ZC (34.G.039)	062.7869.-- (34.G.037)	062.7871.-- (34.G.037)	062.7872.PA (34.G.026)	062.7894.04 (34.G.046)
062.7902.ZC (34.G.039)	062.7903.-- (34.G.038)	062.7927.04 (34.G.046)	062.7937.-- (34.G.040)	062.7952.PA (34.G.027)
062.7953.PA (34.G.027)	062.7961.ZC (34.G.033)	062.7962.ZC (34.G.033)	062.7963.PA (34.G.028)	062.7964.PA (34.G.028)
062.7965.PA (34.G.028)	062.8011.04 (34.G.057)	062.8012.04 (34.G.057)	062.8013.07 (34.G.057)	062.8025.04 (34.G.058)

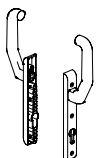
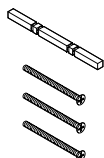
CP 155 CP 155-LS

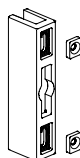
OVERZICHT
APERCU
OVERVIEW
UEBERSICHT

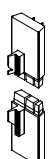

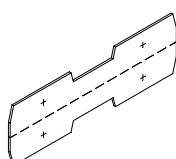
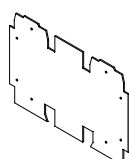
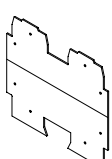
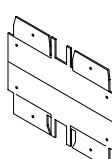
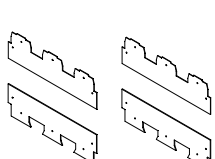
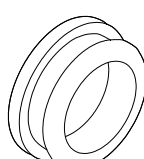
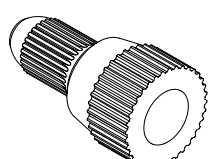
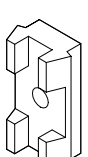
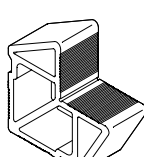
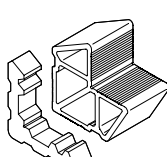
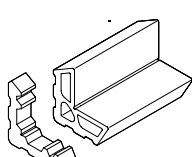
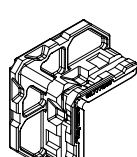
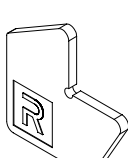
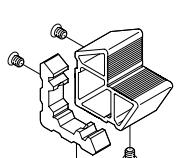
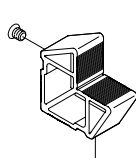
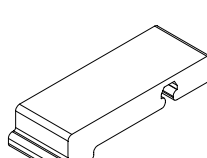
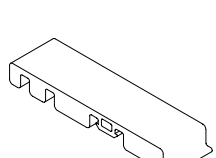
062.8027.04 (34.G.058) 	062.8036.04 (34.G.057) 	062.8037.04 (34.G.057) 	062.8038.07 (34.G.047) 	062.8039.07 (34.G.047) 
062.8045.04 (34.G.046) 	062.8424.XX (34.G.032) 	062.8425.ZC (34.G.034) 	062.8426.ZC (34.G.034) 	062.8431.PA (34.G.031) 
062.8432.PA (34.G.031) 	062.8433.-- (34.G.031) 	062.8434.-- (34.G.035) 	062.8438.-- (34.G.035) 	062.8440.XX (34.G.035) 
062.8441.XX (34.G.035) 	062.9372.04 (34.G.013) 	062.9375.04 (34.G.013) 	062.9392.04 (34.G.059) 	062.9393.04 (34.G.059) 
062.9396.04 (34.G.059) 	062.9397.04 (34.G.059) 	062.9399.04 (34.G.059) 	065.6555.04 (34.G.044) 	068.5920.-- (34.G.020) 
068.6351.04 (34.G.045) 	068.7555.00 (34.G.008) 	068.7558.00 (34.G.008) 	068.7633.00 (34.G.008) 	068.7775.00 (34.G.008) 
068.7776.00 (34.G.011) 	068.8574.00 (34.G.009) 	068.8576.00 (34.G.009) 	068.8682.04 (34.G.019) 	068.8687.04 (34.G.019) 

CP 155 CP 155-LS

OVERZICHT
APERCU
OVERVIEW
UEBERSICHT



068.8730.00 (34.G.014)	068.8731.00 (34.G.014)	068.8732.00 (34.G.015)	068.8733.00 (34.G.015)	068.8734.00 (34.G.016)
068.8740.00 (34.G.017)	068.8741.00 (34.G.017)	068.8742.00 (34.G.018)	068.8743.00 (34.G.018)	068.8779.00 (34.G.021)
068.8835.00 (34.G.009)	069.6569.04 (34.G.010)	069.6575.04 (34.G.010)	069.6747.04 (34.G.044)	069.6761.04 (34.G.045)
069.6830.04 (34.G.044)	069.8422.04 (34.G.044)	069.8704.01 (34.G.041)	069.8724.04 (34.G.041)	069.8748.01 (34.G.041)
071.6554.SY (34.G.046)	080.9114.SY (34.G.051)	080.9116.04 (34.G.051)	080.9118.04 (34.G.051)	080.9120.04 (34.G.052)
080.9123.SY (34.G.048)	080.9124.SY (34.G.048)	080.9125.SY (34.G.049)	080.9126.SY (34.G.049)	080.9128.04 (34.G.050)
080.9130.04 (34.G.050)	080.9253.04 (34.G.053)	080.9381.04 (34.G.053)	080.9424.04 (34.G.053)	080.9430.04 (34.G.054)

CP 155 CP 155-LS

OVERZICHT
APERCU
OVERVIEW
UEBERSICHT



080.9439.04 (34.G.055)	080.9441.04 (34.G.054)	080.9625.07 (34.G.055)	080.9629.07 (34.G.056)	080.9630.07 (34.G.056)
080.9815.SY (34.G.055)	081.9091.04 (34.G.060)	081.9092.04 (34.G.060)	081.9241.07 (34.G.060)	082.5401.-- (34.G.089_01.001)
084.9041.04 (34.G.071)	084.9051.04 (34.G.071)	084.9080.-- (34.G.064)	084.9080.-- (34.G.070)	084.9090.-- (34.G.073)
084.9103.04 (34.G.064)	084.9106.-- (34.G.064)	084.9111.-- (34.G.065)	084.9113.-- (34.G.065)	084.9140.-- (34.G.073)
084.9410.01 (34.G.061)	084.9411.01 (34.G.061)	084.9414.07 (34.G.072)	084.9420.07 (34.G.072)	084.9426.07 (34.G.074)
084.9480.-- (34.G.066)	084.9550.01 (34.G.065)	084.9580.01 (34.G.066)	084.9750.01 (34.G.066)	086.9150.-- (34.G.066)
086.9160.-- (34.G.067)	086.9175.-- (34.G.067)	086.9191.-- (34.G.092)	086.9208.SY (34.G.068)	086.9210.-- (34.G.067)

CP 155 CP 155-LS

OVERZICHT
APERCU
OVERVIEW
UEBERSICHT



086.9211.-- (34.G.068)	086.9213.-- (34.G.067)	086.9225.-- (34.G.068)	086.9551.-- (34.G.068)	086.9600.XX (34.G.069)
095.A730.00 (34.G.105)	095.B323.00 (34.G.106)	095.B532.00 (34.G.110)	095.B533.00 (34.G.110)	095.B533.00 (34.G.111)
095.B534.00 (34.G.111)	095.B561.00 (34.G.112)	095.B562.00 (34.G.112)	095.B565.00 (34.G.113)	095.H810.00 (34.G.107)
095.H850.00 (34.G.109)	095.H853.00 (34.G.109)	095.H856.00 (34.G.109)	095.1000.-- (34.G.114)	095.J200.00 (34.G.114)
097.0009.00 (34.G.093)	097.0010.00 (34.G.094)	097.0014.00 (34.G.096)	097.0047.00 (34.G.095)	097.0296.00 (34.G.097)
097.0410.00 (34.G.094)	097.0437.00 (34.G.095)	097.0440.00 (34.G.098)	097.0441.00 (34.G.098)	097.0683.07 (34.G.097)
097.0698.00 (34.G.096)	097.0754.00 (34.G.115)	097.A200.00 (34.G.108)	097.C000.00 (34.G.108)	097.D300.00 (34.G.108)

CP 155 CP 155-LS

OVERZICHT
APERCU
OVERVIEW
UEBERSICHT

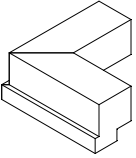
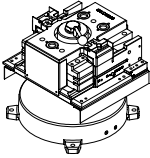
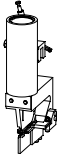
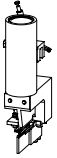
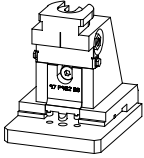
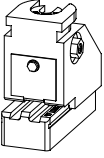
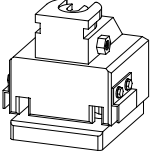
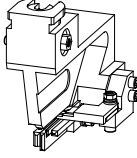
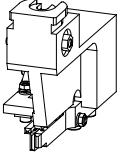
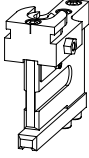

097.E900.00 (34.G.108) 	097.L700.00 (34.G.104) 	097.O900.00 (34.G.099) 	097.P000.00 (34.G.099) 	097.P900.00 (34.G.102) 
097.U300.00 (34.G.103) 	097.U400.00 (34.G.103) 	097.X000.00 (34.G.100) 	097.X100.00 (34.G.100) 	097.X300.00 (34.G.101) 

CP 155 CP 155-LS

PERSHOEKEN
EQUERRES A SERTIR
CRIMP CORNER CLEATS
PRESSECKWINKEL

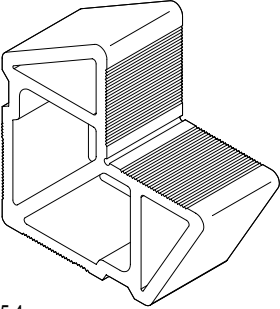
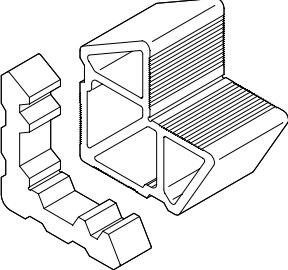
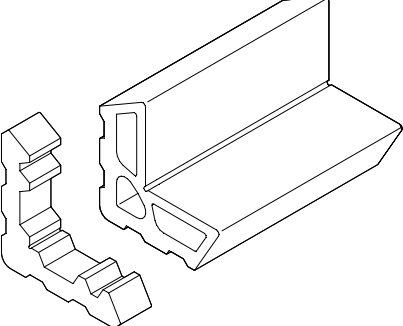
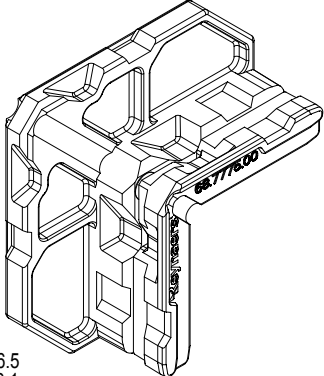

 <p>H=75.4 B=75.4 D=28.3</p>	<p>068.7555.00</p> <p>PERSHOEK 39.2x28.3 EQUERRE A SERTIR 39.2x28.3 CRIMP CORNER CLEAT 39.2x28.3 PRESSECKWINKEL 39.2x28.3</p>	<p>CP 155 006.1300.XX 006.1400.XX</p> <p>CP 155-LS 006.1300.XX 006.1400.XX</p> <p>CP 155-AP 006.1300.XX</p> <p>CP 155-LS/AP 006.1300.XX</p>		
 <p>H=66.8/75.4 B=66.8/75.4 D=17.4/28.3</p>	<p>068.7558.00</p> <p>PERSHOEKEN 15.8x17.4 - 39.2x41.6 EQUERRES A SERTIR 15.8x17.4 - 39.2x41.6 CRIMP CORNER CLEATS 15.8x17.4 - 39.2x41.6 PRESSECKWINKEL 15.8x17.4 - 39.2x41.6</p>	<p>CP 155 006.0320.XX</p> <p>CP 155-LS 006.0320.XX</p> <p>CP 155-AP 006.0320.XX</p> <p>CP 155-LS/AP 006.0320.XX</p>		
 <p>H=66.74/67 B=66.74/67 D=17.4/84</p>	<p>068.7633.00</p> <p>PERSHOEKEN 15.8x17.4 - 25.8x84 EQUERRES A SERTIR 15.8x17.4 - 25.8x84 CRIMP CORNER CLEATS 15.8x17.4 - 25.8x84 PRESSECKWINKEL 15.8x17.4 - 25.8x84</p>	<p>CP 155 008.3848.XX</p> <p>CP 155-LS 008.3848.XX</p> <p>CS 77</p>		
 <p>H=86.5 B=36.1 D=86.5</p>	<p>068.7775.00</p> <p>PERSHOEK 39.2x36.1 EQUERRE A SERTIR 39.2x36.1 CRIMP CORNER CLEAT 39.2x36.1 PRESSECKWINKEL 39.2x36.1</p>	<p>CP 155 006.2340.XX 006.2344.XX</p> <p>CP 155-LS 006.2340.XX 006.2344.XX</p> <p>CP 155-AP 006.2340.XX 006.2344.XX</p> <p>CP 155-LS/AP 006.2340.XX 006.2344.XX</p>		

CP 155 CP 155-LS

SCHROEFHOEKEN
EQUERRES A VISSER
SCREW CORNER CLEATS
SCHRAUBECKWINKEL



	<p>068.8574.00</p> <p>SCHROEFHOEKEN 15.8x17.4 - 34.2x41.6 EQUERRES A VISSER 15.8x17.4 - 34.2x41.6 SCREW CORNER CLEATS 15.8x17.4 - 34.2x41.6 SCHRAUBECKWINKEL 15.8x17.4 - 34.2x41.6</p>	<p>CP 155 006.0320.XX</p> <p>CP 155-LS 006.0320.XX</p> <p>CP 155-AP CP 155-LS/AP</p>		<p>4 st./pc 050.5091.--</p> <p>M8 x 10</p>
	<p>068.8576.00</p> <p>SCHROEFHOEK 39.2x28.3 EQUERRE A VISSER 39.2x28.3 SCREW CORNER CLEAT 39.2x28.3 SCHRAUBECKWINKEL 39.2x28.3</p>	<p>CP 155 006.1300.XX 006.1400.XX</p> <p>CP 155-LS 006.1300.XX 006.1400.XX</p> <p>CP 155-AP CP 155-LS/AP</p>		<p>2 st./pc 050.5091.--</p> <p>M8 x 10</p>
	<p>068.8835.00</p> <p>SCHROEFHOEKEN 26.2x10.4 - 12.4x36.1 EQUERRES A VISSER 26.2x10.4 - 12.4x36.1 SCREW CORNER CLEATS 26.2x10.4 - 12.4x36.1 SCHRAUBECKWINKEL 26.2x10.4 - 12.4x36.1</p>	<p>CP 155 006.2340.XX 006.2344.XX</p> <p>CP 155-LS 006.2340.XX 006.2344.XX</p> <p>CP 155-AP CP 155-LS/AP</p>		<p>2 st./pc 068.8937.--</p> <p>Ø4 x 60</p>

CP 155 CP 155-LS

VULHOEKEN
EQUERRES DE REMPLISSAGE
CORNER SUPPORTS
FUELLECKWINKEL

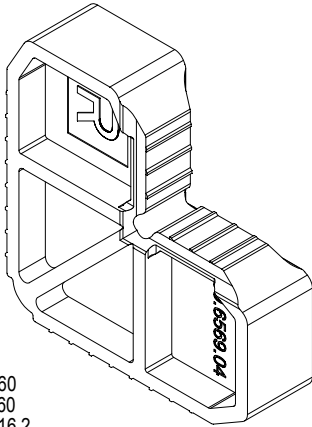

H=60
B=60
D=16.2

069.6569.04

VULHOEK 32.1x16.2
EQUERRE DE REMPLISSAGE 32.1x16.2
CORNER SUPPORT 32.1x16.2
FUELLECKWINKEL 32.1x16.2

CP 155
006.2340.XX
006.2344.XX

CP 155-LS
006.2340.XX
006.2344.XX

CP 155-AP
CP 155-LS/AP

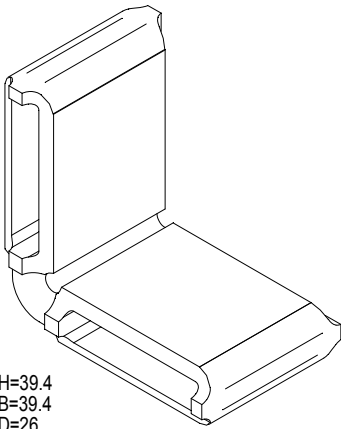

H=39.4
B=39.4
D=26

069.6575.04

VULHOEK 9.1x26
EQUERRE DE REMPLISSAGE 9.1x26
CORNER SUPPORT 9.1x26
FUELLECKWINKEL 9.1x26

CP 155
006.0320.XX

CP 155-LS
006.0320.XX

CP 130
CP 155-AP
CP 155-LS/AP

CS 77

CP 155 CP 155-LS

STEUNHOEKEN
CALES DE FEUILLURE
REBATE SUPPORTS
ECKWINKEL GLASANSCHLAG

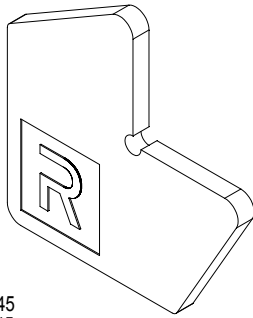

H=45
B=45
D=3

068.7776.00

STEUNHOEK
CALE DE FEUILLURE
REBATE SUPPORT
ECKWINKEL

CP 155
006.2340.XX
006.2344.XX

TP 110
TP 110-Re

CP 155-LS
006.2340.XX
006.2344.XX

CP 155-AP
006.2340.XX
006.2344.XX

CP 155-LS/AP
006.2340.XX
006.2344.XX



060.8723.--

STEUNHOEK 21x1
CALE DE FEUILLURE 21x1
REBATE SUPPORT 21x1
ECKWINKEL 21x1

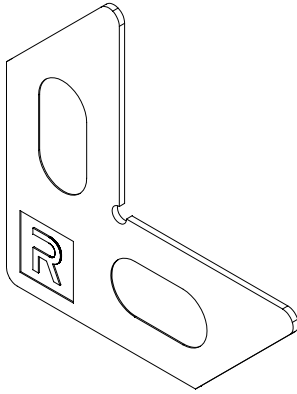

CP 155	CS 59Pa	CR 120	CS 77-Re
006.0320.XX	CS 59	CS 77	CF 77
006.2340.XX	CS 59-HV	CS 77-HV	CS 77-SP
006.2344.XX	CS 59-Re	CS 77-BP	CS 77 Optima
008.3113.XX	CS 59-So	CS 77-FP	CF 77-AP
008.3114.XX	CS 59-AD	CP 155-AP	
008.3120.XX	CS 59-CD	CP 155-LS/AP	MEDAS
008.3123.XX	CS 59-SD	CP 96	CW 60-HI
008.3848.XX	CS 68	CW 60-DRCS	68 Optima-AP
	CS 68-HV	CP 96-LS	CS 104
CP 155-LS	CS 68-Re	CP 96-AP	
006.0320.XX	CS 68-So	CP 96-LS/AP	
006.2340.XX	TP 110	TP 110-Re	
006.2344.XX	CP 130	CS 68 Optima	
008.3113.XX	CP 130-LS	Eco system	
008.3114.XX	CW 50	CS 38-SL	
008.3120.XX	CW 50-HI	CS 86-HI	
008.3123.XX	CW 60	Eco system-AP	
008.3848.XX	TR 200	CS 38-SL/AP	
	CS 68-FP	BS 40	

H=50
B=50
D=1

060.8746.00

STEUNHOEK 16.4x3.5
CALE DE FEUILLURE 16.4x3.5
REBATE SUPPORT 16.4x3.5
ECKWINKEL 16.4x3.5

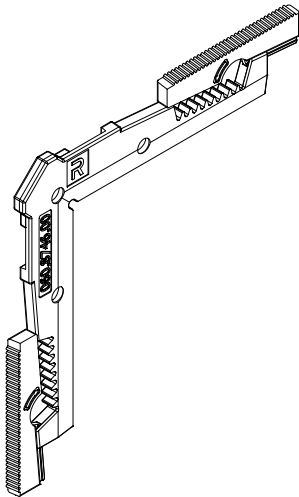

CP 155	008.3824.XX	CW 50-HI	CS 104
006.0320.XX	008.3848.XX	CW 60	CS 77-SP
006.2340.XX	0K8.3824.XX	TR 200	CS 77 Optima
006.2344.XX		CS 68-FP	CF 77-AP
008.3113.XX	CS 59Pa	CR 120	
008.3114.XX	CS 59	CS 77	CS 38-SL
008.3120.XX	CS 59-HV	CS 77-HV	CS 38-SL/AP
008.3123.XX	CS 59-Re	CS 77-BPCS	68 Optima-AP
008.3824.XX	CS 59-So	CS 77-FP	
008.3848.XX	CS 59-AD	CP 155-AP	
0K8.3824.XX	CS 59-CD	CP 155-LS/AP	
	CS 59-SD	CP 96	
CP 155-LS	CS 68	CW 60-DRL	
006.0320.XX	CS 68-HV	CP 96-LS	
006.2340.XX	CS 68-Re	TP 110-Re	
006.2344.XX	CS 68-So	CS 68 Optima	
008.3113.XX	TP 110	CS 86-HI	
008.3114.XX	CP 130	BS 40	
008.3120.XX	CP 130-LS	CS 77-Re	
008.3123.XX	CW 50	CF 77	

H=91.5
B=91.5
D=3.5

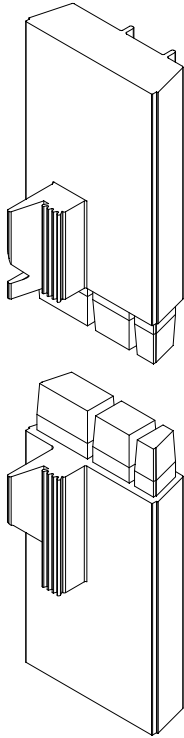

062.9372.04

SET EINDSTUKKEN
SET PIECES FINALES
SET END PIECES
SATZ ENDKAPPEN

CP 155-LS
006.0305.04

H=90
B=48.3
D=36.4

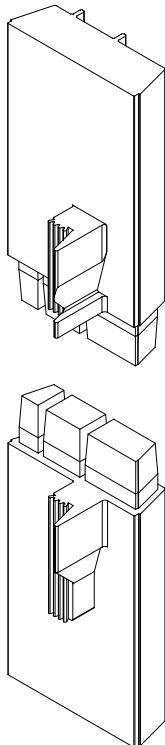

062.9375.04

SET EINDSTUKKEN
SET PIECES FINALES
SET END PIECES
SATZ ENDKAPPEN

CP 155-LS
006.0305.04

H=90
B=48.3
D=36.4

CP 155 CP 155-LS

T-VERBINDING
RACCORDEMENT-T
T-CONNECTION
T-VERBINDUNG



068.8730.00

T-VERBINDER 5x14MM
JONCTION-T 5x14MM
T-BRACKET 5x14MM
T-VERBINDER 5x14MM

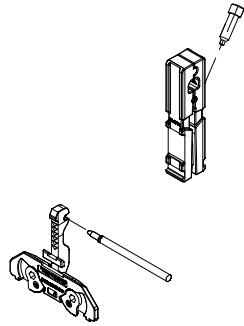

CP 155 006.2340.XX 008.3113.XX	CW 50-HI CW 60 CS 68-FP CS 77
CP 155-LS 006.2340.XX 008.3113.XX	CS 77-HV CP 155-AP CP 155-LS/AP CW 60-DRL
CS 59 CS 59-HV CS 59-Re CS 59-So CS 68	CS 86-HI CS 77-Re CF 77 CF 77-AP
CS 68-HV CS 68-Re CS 68-So TP 110 CP 130 CP 130-LS CW 50	CS 59-AD CS 59-CD CS 59-SD CS 59-AP CS 68-AP CS 77-AP CS 77-BP

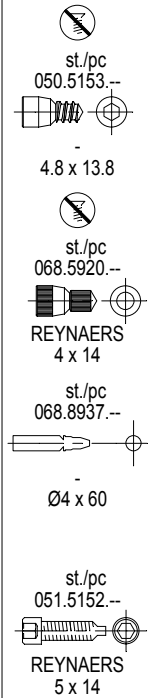

050.5153.-- = T-connection screw
068.5920.-- = T-connection drive pin
H=55.8/73.3 - B=64/12.5 - D=10.2/17.4

068.8731.00

T-VERBINDER 17.7x25.8MM
JONCTION-T 17.7x25.8MM
T-BRACKET 17.7x25.8MM
T-VERBINDER 17.7x25.8MM

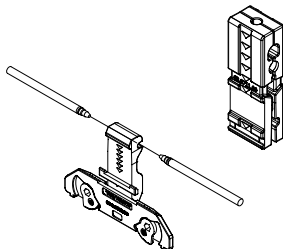

CP 155 008.3120.XX	CS 86-HI CS 77-Re CF 77
CP 155-LS 006.0350.XX 008.3120.XX	CS 104 CF 77-AP
CS 59 CS 59-Re CS 59-So CS 68 CS 68-HV CS 68-Re CS 68-So TP 110 CP 130 CP 130-LS CS 68-FP CS 77 CS 77-HV	

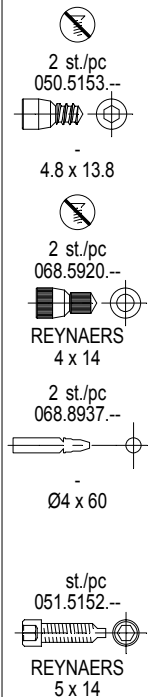

050.5153.-- = T-connection screw
068.5920.-- = T-connection drive pin
H=55.8/73.3 - B=79/25.8 - D=10.2/17.4

CP 155 CP 155-LS

T-VERBINDING
RACCORDEMENT-T
T-CONNECTION
T-VERBINDUNG



068.8732.00

T-VERBINDER 30.9x38.8MM
JONCTION-T 30.9x38.8MM
T-BRACKET 30.9x38.8MM
T-VERBINDER 30.9x38.8MM

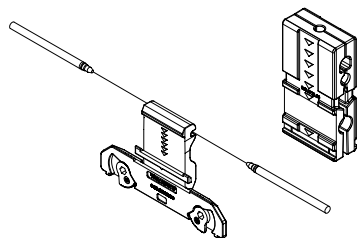

- | | | | | | |
|--------------------------|----------------------------------|--|--|--|--|
| CP 155
008.3114.XX | CS 77-SP
CF 77-AP | | | | |
| CP 155-LS
008.3114.XX | CS 59-HV
CS 59-Re
CS 59-So | | | | |
| CS 59 | CS 59-AD | | | | |
| CS 68 | CS 59-CD | | | | |
| CS 68-HV | CS 59-SD | | | | |
| TP 110 | CS 68-Re | | | | |
| CP 130 | CS 68-So | | | | |
| CP 130-LS | CS 59-AP | | | | |
| CS 68-FP | CS 68-AP | | | | |
| CS 77 | CS 77-AP | | | | |
| CS 77-HV | | | | | |
| CS 77-BP | | | | | |
| CS 77-FP | | | | | |
| CS 86-HI | | | | | |
| CF 77 | | | | | |
| CS 104 | | | | | |

050.5153.-- = T-connection screw
068.5920.-- = T-connection drive pin
H=55.8/73.3 - B=92/38.8 - D=10.2/17.4

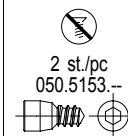

2 st./pc
050.5153.--

4.8 x 13.8

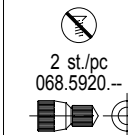

2 st./pc
068.5920.--

REYNAERS
4 x 14

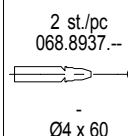

2 st./pc
068.8937.--

Ø4 x 60

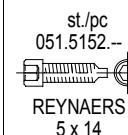

st./pc
051.5152.--

REYNAERS
5 x 14

068.8733.00

T-VERBINDER 43.9x38.8MM
JONCTION-T 43.9x38.8MM
T-BRACKET 43.9x38.8MM
T-VERBINDER 43.9x38.8MM

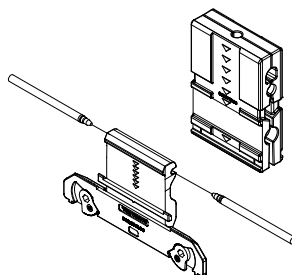

- | | | | | | |
|--------------------------|----------------------------------|--|--|--|--|
| CP 155
008.3123.XX | CS 59-AD
CS 59-CD
CS 59-SD | | | | |
| CP 155-LS
008.3123.XX | CS 68-HV
CS 68-Re
CS 68-So | | | | |
| CS 59 | CS 77-HV | | | | |
| CS 68 | CS 59-AP | | | | |
| TP 110 | CS 68-AP | | | | |
| CP 130 | CS 77-AP | | | | |
| CP 130-LS | CS 77-BP | | | | |
| CS 68-FP | | | | | |
| CS 77 | | | | | |
| CS 86-HI | | | | | |
| CF 77 | | | | | |
| CF 77-AP | | | | | |
| CS 59-HV | | | | | |
| CS 59-Re | | | | | |
| CS 59-So | | | | | |

050.5153.-- = T-connection screw
068.5920.-- = T-connection drive pin
H=55.8/73.3 - B=105/51.8 - D=10.2/17.4

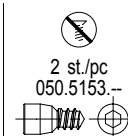

2 st./pc
050.5153.--

4.8 x 13.8

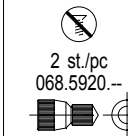

2 st./pc
068.5920.--

REYNAERS
4 x 14

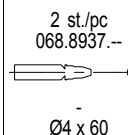

2 st./pc
068.8937.--

Ø4 x 60

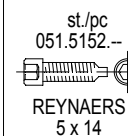

st./pc
051.5152.--

REYNAERS
5 x 14

CP 155 CP 155-LS

T-VERBINDER
JONCTION-T
T-BRACKET
T-VERBINDER



068.8734.00

T-VERBINDER 2x 17.9x25.8MM
JONCTION-T 2x 17.9x25.8MM
T-BRACKET 2x 17.9x25.8MM
T-VERBINDER 2x 17.9x25.8MM



2 st./pc
050.5153.--

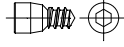

-
4.8 x 13.8



2 st./pc
068.5920.--



REYNAERS
4 x 14

2 st./pc
068.8937.--



-
Ø4 x 60

2 st./pc
051.5152.--

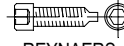

REYNAERS
5 x 14

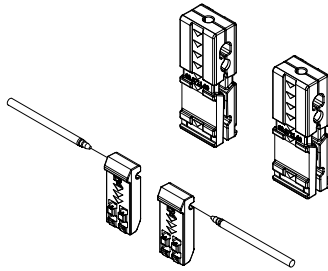

CP 155
008.3824.XX
0K8.3824.XX

CP 155-LS
008.3824.XX
0K8.3824.XX

CS 59
CS 59-AD
CS 68
CP 130
CP 130-LS
CS 68-FP
CS 77
CS 86-HI
CF 77
CS 77-SP
CF 77-AP



050.5153.-- = T-connection screw
068.5920.-- = T-connection drive pin
H=41/73.3 - B=17.9/25.8 - D=10.2/17.4

D00014010

CP 155 CP 155-LS

T-VERBINDERS
JONCTIONS-T
T-BRACKETS
T-VERBINDER



068.8740.00

T-VERBINDER 5x14MM
JONCTION-T 5x14MM
T-BRACKET 5x14MM
T-VERBINDER 5x14MM

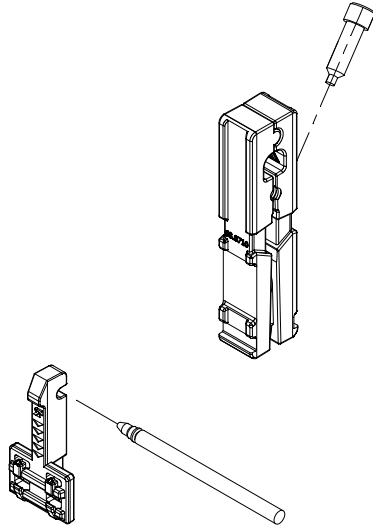

- | | |
|---|---|
| CP 155
008.3113.XX | CS 68-FP
CS 77
CS 77-HV
CW 60-DRL
CS 86-HI
CS 77-Re
CF 77
CF 77-AP |
| CP 155-LS
008.3113.XX | |
| CS 59
CS 59-HV
CS 59-Re
CS 59-So
CS 68
CS 68-HV
CS 68-Re
CS 68-So
TP 110
CP 130
CP 130-LS
CW 50
CW 50-HI
CW 60 | CS 59-AD
CS 59-CD
CS 59-SD
CS 59-AP
CS 68-AP
CS 77-AP
CS 77-BP |



050.5153.-- = T-connection screw
068.5920.-- = T-connection drive pin
H=42/73.3 B=22/12.5 D=10.2/17.4



st./pc
050.5153.--

4.8 x 13.8



st./pc
068.5920.--

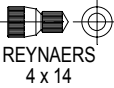

REYNAERS
4 x 14

st./pc
068.8937.--

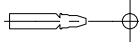

Ø4 x 60

st./pc
051.5152.--



REYNAERS
5 x 14

068.8741.00

T-VERBINDER 17.9x25.8MM
JONCTION-T 17.9x25.8MM
T-BRACKET 17.9x25.8MM
T-VERBINDER 17.9x25.8MM

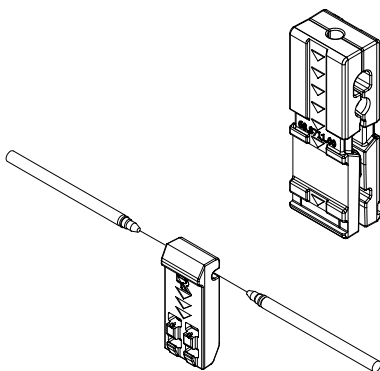

- | | |
|--|---|
| CP 155
008.3120.XX | CS 77-Re
CF 77
CS 104
CF 77-AP |
| CP 155-LS
008.3120.XX | |
| CS 59
CS 59-Re
CS 59-So
CS 68
CS 68-HV
CS 68-Re
CS 68-So
TP 110
CP 130
CP 130-LS
CS 68-FP
CS 77
CS 77-HV
CS 86-HI | |



050.5153.-- = T-connection screw
068.5920.-- = T-connection drive pin
H=42/73.27 B=17.9/25.77 D=10.2/17.4

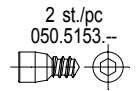

2 st./pc
050.5153.--

4.8 x 13.8



2 st./pc
068.5920.--



REYNAERS
4 x 14

2 st./pc
068.8937.--

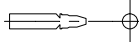

Ø4 x 60

st./pc
051.5152.--



REYNAERS
5 x 14

CP 155 CP 155-LS

T-VERBINDERS
JONCTIONS-T
T-BRACKETS
T-VERBINDER



068.8742.00

T-VERBINDER 30.9x38.8MM
JONCTION-T 30.9x38.8MM
T-BRACKET 30.9x38.8MM
T-VERBINDER 30.9x38.8MM

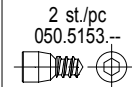

2 st./pc
050.5153.--

4.8 x 13.8

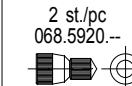

2 st./pc
068.5920.--

REYNAERS
4 x 14

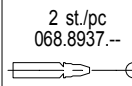

2 st./pc
068.8937.--

Ø4 x 60

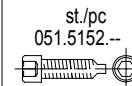

st./pc
051.5152.--

REYNAERS
5 x 14

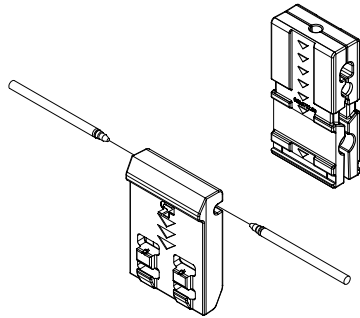

- | | |
|--------------------------|----------------------------------|
| CP 155
008.3114.XX | CS 77-SP
CF 77-AP |
| CP 155-LS
008.3114.XX | CS 59-HV
CS 59-Re
CS 59-So |
| CS 59 | CS 59-AD |
| CS 68 | CS 59-CD |
| CS 68-HV | CS 59-SD |
| TP 110 | CS 68-Re |
| CP 130 | CS 68-So |
| CP 130-LS | CS 59-AP |
| CS 68-FP | CS 68-AP |
| CS 77 | CS 77-AP |
| CS 77-HV | |
| CS 77-BP | |
| CS 77-FP | |
| CS 86-HI | |
| CF 77 | |
| CS 104 | |

050.5153.-- = T-connection screw
068.5920.-- = T-connection drive pin
H=42/73.3 B=30.9/38.8 D=10.2/17.4

068.8743.00

T-VERBINDER 43.9x38.8MM
JONCTION-T 43.9x38.8MM
T-BRACKET 43.9x38.8MM
T-VERBINDER 43.9x38.8MM

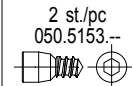

2 st./pc
050.5153.--

4.8 x 13.8

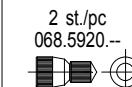

2 st./pc
068.5920.--

REYNAERS
4 x 14

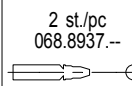

2 st./pc
068.8937.--

Ø4 x 60

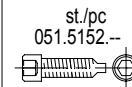

st./pc
051.5152.--

REYNAERS
5 x 14

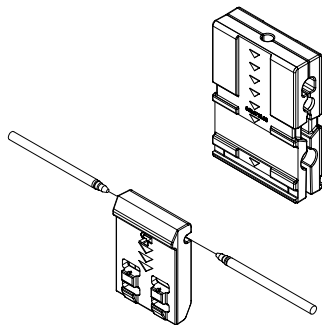

- | | |
|--------------------------|----------------------------------|
| CP 155
008.3123.XX | CS 59-AD
CS 59-CD
CS 59-SD |
| CP 155-LS
008.3123.XX | CS 68-HV
CS 68-Re
CS 68-So |
| CS 59 | CS 77-HV |
| CS 68 | CS 59-AP |
| TP 110 | CS 68-AP |
| CP 130 | CS 77-AP |
| CP 130-LS | CS 77-BP |
| CS 68-FP | |
| CS 77 | |
| CS 86-HI | |
| CF 77 | |
| CF 77-AP | |
| CS 59-HV | |
| CS 59-Re | |
| CS 59-So | |

050.5153.-- = T-connection screw
068.5920.-- = T-connection drive pin
H=42/73.3 B=43.9/51.8 D=10.2/17.4

CP 155 CP 155-LS

AFDICHTINGSSTUK T-VERBINDER
PIECE D'ETANCHEITE JONCTION-T
SEALING T-BRACKET
ABDICHTUNG T-VERBINDER

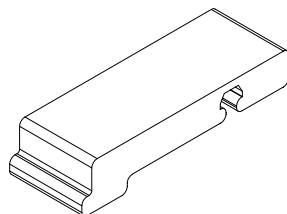

068.8682.04

AFDICHTINGSSTUK T-VERBINDER
PIECE D'ETANCHEITE JONCTION-T
SEALING T-BRACKET
ABDICHTUNG T-VERBINDER

CP 155					
006.0320.XX	CW 50				
008.3113.XX	CW 50-HI				
008.3114.XX	CW 60				
008.3120.XX	CS 77				
008.3123.XX	CS 77-HV				
008.3824.XX	CS 77-BP				
0K8.3824.XX	CS 77-FP				
	CP 155-AP				
CP 155-LS	CP 155-LS/AP				
006.0320.XX	CW 60-DRL				
006.0324.XX	CS 77-Re				
006.0326.XX	CS 77-SP				
006.1322.XX					
008.3113.XX					
008.3114.XX					
008.3120.XX					
008.3123.XX					
008.3824.XX					
0K8.3824.XX					

H=8.3
B=13.5
D=41.7

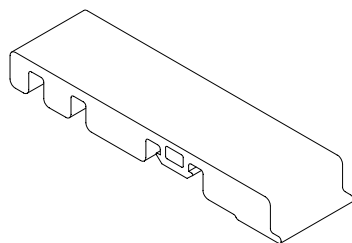

068.8687.04

AFDICHTINGSSTUK T-VERBINDER
PIECE D'ETANCHEITE JONCTION-T
SEALING T-BRACKET
ABDICHTUNG T-VERBINDER

CP 155-LS					
006.0321.XX					
006.0323.XX					
006.0327.XX					
CS 86-HI					
CF 77					
CF 77-AP					

H=6.3
B=50.7
D=13.5

CP 155 CP 155-LS

T-VERBINDER
JONCTION-T
T-BRACKET
T-VERBINDER



050.5153.--

SCHROEF 4.8x13.8MM
VIS 4.8x13.8MM
SCREW 4.8x13.8MM
SCHRAUBE 4.8x13.8MM

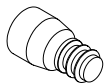

CP 155	CS 59-So	Eco system
008.0114.XX	CS 59-AD	CS 86-HI
008.3113.XX	CS 68	Eco system-AP
008.3114.XX	CS 68-HV	CS 77-Re
008.3120.XX	CS 68-Re	Eco system Optima
008.3123.XX	CS 68-So	CF 77
008.3824.XX	TP 110	
OK8.3824.XX	CP 130	CS 59-CD
	CP 130-LS	CS 59-SD
CP 155-LS	CW 50	CS 59-AP
008.3113.XX	CW 50-HI	CS 68-AP
008.3114.XX	CW 60	CS 77-AP
008.3120.XX	CS 68-FP	
008.3123.XX	CR 120	
008.3824.XX	CS 77	
OK8.3824.XX	CS 77-HV	
	CS 77-BP	
	CS 77-FP	
CS 59	CW 60-DRL	
CS 59-HV	TP 110-Re	
CS 59-Re		

H= Ø6.9
B= 13.8

068.5920.--

NAGEL T-VERBINDER Ø7mm
CLOU JONCTION-T Ø7mm
DRIVE PIN T-BRACKET Ø7mm
STIFT T-VERBINDER Ø7mm

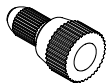

CP 155	CS 59-So	Eco system-AP
008.0114.XX	CS 68	CS 77-Re
008.3113.XX	CS 68-HV	Eco system Optima
008.3114.XX	CS 68-Re	CF 77
008.3120.XX	CS 68-So	
008.3123.XX	TP 110	CS 59-AD
008.3824.XX	CP 130	CS 59-CD
OK8.3824.XX	CP 130-LS	CS 59-SD
	CW 50	CS 59-AP
CP 155-LS	CW 50-HI	CS 68-AP
008.3113.XX	CW 60	CS 77-AP
008.3114.XX	CS 68-FP	
008.3120.XX	CR 120	
008.3123.XX	CS 77	
008.3824.XX	CS 77-HV	
OK8.3824.XX	CS 77-BP	
	CS 77-FP	
CS 59	CW 60-DRL	
CS 59-HV	Eco system	
CS 59-Re	CS 86-HI	

H= Ø7

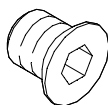

050.5091.--

SCHROEF INOX M8x10
 VIS INOX M8x10
 SCREW INOX M8x10
 SCHRAUBE INOX M8x10

CP 130	Eco system-AP
CI 45	CS 38-SL/AP
	PR 100
PS 50-SP	CF 77
CS 59Pa	CS 104
CS 59	CP 45Pa (GR)
CS 68	CS 77-SP
TP 110	Eco PL
TP 138	CF 77-AP
TLS 110	
CP 155	
CP 155-LS	
CW 50	
TR 200	
CS 77	
CP 45Pa	
TP 110-Re	
Eco system	
CS 38-SL	
CS 86-HI	

H=Ø8
 B=10

068.8779.00

T-VERBINDER VARIABLE
 JUNCTION-T VARIABLE
 VARIABLE T-BRACKET
 VARIABELER T-VERBINDER

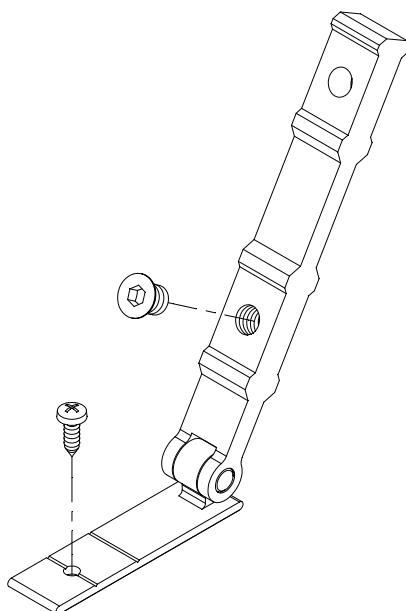

CP 155	CS 68-HV	CS 77-SP
008.3113.XX	CS 68-Re	CF 77-AP
008.3114.XX	CS 68-So	
008.3120.XX	TP 110	Eco PL
008.3123.XX	CP 130	
008.3824.XX	CP 130-LS	
0K8.3824.XX	CW 50	
	CW 60	
CP 155-LS	CS 68-FP	
008.3113.XX	CS 77	
008.3114.XX	CS 77-HV	
008.3120.XX	CS 77-BP	
008.3123.XX	CS 77-FP	
008.3824.XX	TP 110-Re	
0K8.3824.XX	Eco system	
	CS 86-HI	
CS 59	Eco system-AP	
CS 59-Re	CS 77-Re	
CS 59-So	CF 77	
CS 68	CS 104	

st./pc
 052.5317.--

 DIN 7981
 4.2 x 13
 st./pc
 050.5091.--

 -
 M8 x 10

H=65 B=65 D=17/18
 USE WITH 068.8906.04

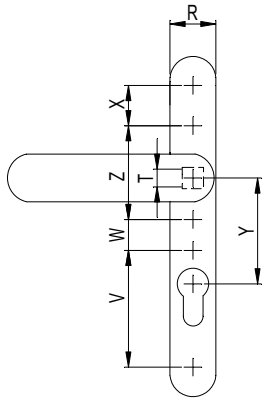

	BEVESTIGINGSSET SET DE FIXATION FIXATION SET		
	TP 110	CP 130	CP 155
	061.7097.--	061.7097.--	061.7098.--
	+ 050.5073.--	+ 050.5074.--	+ 050.5083.--

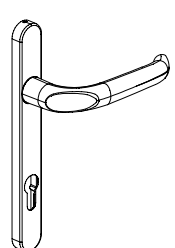
061.7130.PA

DEURKRUK BINNEN
BEQUILLE INTERIEURE
DOOR HANDLE INSIDE
TUERDRUECKER INNEN
MANETA PUERTA INTERIOR
KLAMKA DRZWIOWA WEWNETRZNA

H=221 B=71 D=140
V=88 W=30.5 Z=43 X=24.5 Y=92
R=26.5 T=8

CP 155
006.2340.XX

CS 59
CS 68
TP 110
CS 77
Eco system
CS 86-HI
CS 104
CS 77-SP

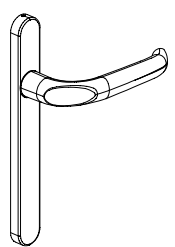

061.7131.PA

DEURKRUK BINNEN
BEQUILLE INTERIEURE
DOOR HANDLE INSIDE
TUERDRUECKER INNEN
MANETA PUERTA INTERIOR
KLAMKA DRZWIOWA WEWNETRZNA

H=221 B=71 D=140
V=88 W=30.5 Z=43 X=24.5
R=26.5 T=8

CP 155
006.2340.XX

CS 59
CS 68
TP 110
CS 77
Eco system
CS 86-HI
CS 104
CS 77-SP

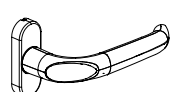

061.7132.PA

DEURKRUK
BEQUILLE
DOOR HANDLE
TUERDRUECKER
MANETA PUERTA
KLAMKA DRZWIOWA

H=72 B=71 D=140
Z=43 T=8 R=26.5

CP 155
006.2340.XX

CF 77
CS 77-SP
CF 77-AP

2 st./pc
050.5161.--

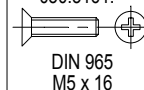

DIN 965
M5 x 16



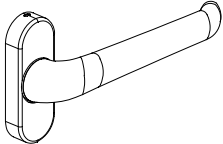
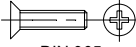
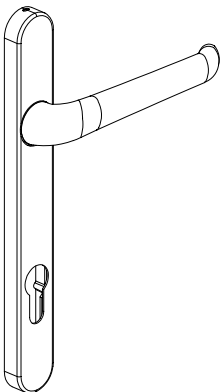
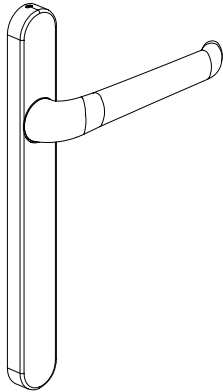

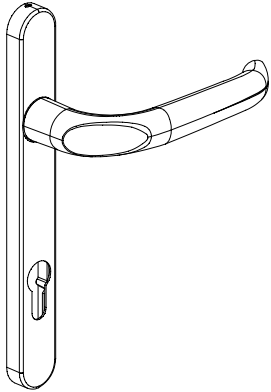
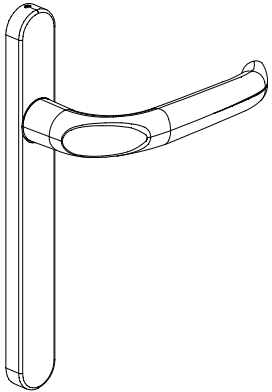
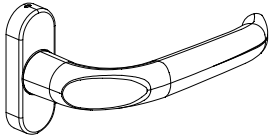



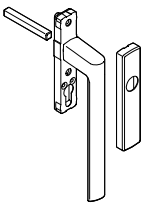
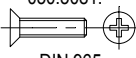
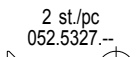
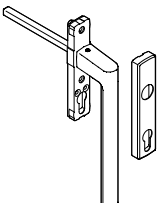
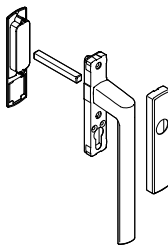
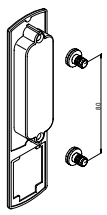

 <p>H=72 B=29 D=140 Z=43 T=8 R=26.5</p>	<p>061.7133.PA DEURKRUK BEQUILLE DOOR HANDLE TUERDRUECKER</p>	<p>CP 155 006.2340.XX CF 77 CF 77-AP</p>	<p>2 st./pc 050.5161.--  DIN 965 M5 x 16</p>
 <p>H=221 B=30 D=140 V=88 W=30.5 Z=43 X=24.5 Y=92 R=26.5 T=8</p>	<p>061.7134.PA DEURKRUK BINNEN BEQUILLE INTERIEURE DOOR HANDLE INSIDE TUERDRUECKER INNEN</p>	<p>CP 155 006.2340.XX CS 59 CS 68 TP 110 CS 77 Eco system CS 86-HI CS 104</p>	
 <p>H=221 B=30 D=140 V=88 W=30.5 Z=43 X=24.5 R=26.5 T=8</p>	<p>061.7135.PA DEURKRUK BINNEN BEQUILLE INTERIEURE DOOR HANDLE INSIDE TUERDRUECKER INNEN</p>	<p>CP 155 006.2340.XX CS 59 CS 68 TP 110 CS 77 Eco system CS 86-HI CS 104</p>	

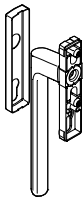
 <p>H=221 B=71 D=140 V=88 W=30.5 Z=43 X=24.5 Y=92 R=26.5 T=8</p>	<p>061.7140.PA</p> <p>DEURKUK BUITEN BEQUILLE EXTERIEURE DOORHANDLE OUTSIDE TUERDRUECKER AUSSEN</p>	<p>CP 155 006.2340.XX</p> <p>CS 59 CS 68 TP 110 CS 77 Eco system CS 86-HI CS 104 CS 77-SP</p>		
 <p>H=221 B=71 D=140 V=88 W=30.5 Z=43 X=24.5 R=26.5 T=8</p>	<p>061.7141.PA</p> <p>DEURKUK BUITEN BEQUILLE EXTERIEURE DOORHANDLE OUTSIDE TUERDRUECKER AUSSEN</p>	<p>CP 155 006.2340.XX</p> <p>CS 59 CS 68 TP 110 CS 77 Eco system CS 86-HI CS 104 CS 77-SP</p>		
 <p>H=72 B=71 D=140 Z=43 R=26.5 T=8</p>	<p>061.7142.PA</p> <p>DEURKUK BUITEN BEQUILLE EXTERIEURE DOORHANDLE OUTSIDE TUERDRUECKER AUSSEN</p>	<p>CP 155 006.2340.XX</p> <p>CS 59 CS 68 CP 130 CS 77 Eco system CS 86-HI CS 104 CS 77-SP</p>		

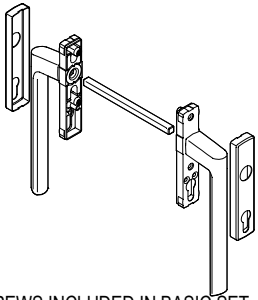
<p>H=72 B=11 D=26.5</p>	<p>061.6992.PA CILINDERPLAAT ECUSSON CYLINDER COVER PZ-ROZETTE</p>	<p>CS 59 CS 68 CP 155 CS 77 Eco system CS 86-HI CS 104 CS 77-SP</p>	<p>2 st./pc 052.5316.-- DIN 7982 4.2 x 19</p>
<p>H=72 B=30 D=140 Z=43 R=26.5 T=8</p>	<p>061.7143.PA DEURKRUUK BUITEN BEQUILLE EXTERIEURE DOORHANDLE OUTSIDE TUERDRUECKER AUSSEN</p>	<p>CP 155 006.2340.XX CS 59 CS 68 CP 130 CS 77 Eco system CS 86-HI CS 104</p>	
<p>H=221 B=30 D=140 V=88 W=30.5 Z=43 X=24.5 Y=92 R=26.5 T=8</p>	<p>061.7144.PA DEURKRUUK BUITEN BEQUILLE EXTERIEURE DOORHANDLE OUTSIDE TUERDRUECKER AUSSEN</p>	<p>CP 155 006.2340.XX CS 59 CS 68 TP 110 CS 77 Eco system CS 86-HI CS 104</p>	
<p>H=221 B=30 D=140 V=88 W=30.5 Z=43 X=24.5 R=26.5 T=8</p>	<p>061.7145.PA DEURKRUUK BUITEN BEQUILLE EXTERIEURE DOORHANDLE OUTSIDE TUERDRUECKER AUSSEN</p>	<p>CP 155 006.2340.XX CS 59 CS 68 TP 110 CS 77 Eco system CS 86-HI CS 104</p>	



 <p>SCREWS INCLUDED IN BASIC SET QXQ --> 2X050.5081.--/2X052.5327.-- ONLY AVAILABLE IN PAINTED FINISH</p>	<p>062.7861.PA DEURKRUK BINNEN BEQUILLE INTERIEURE DOOR HANDLE INSIDE TUERDRUECKER INNEN</p> <p>X=69 Y=40 Z=80 / H=278 B=74 D=30.5</p>	<p>CP 155-LS 006.2340.XX</p> <p>CP 155-LS/AP 006.2344.XX</p> <p>CP 96-LS CP 96-LS/AP CP 130-LS</p> <p>TLS 110</p>	<p>2 st./pc 050.5081.--</p>  <p>DIN 965 M5 x 45</p> <p>2 st./pc 052.5327.--</p>  <p>DIN 7982 4.2 x 25</p>
 <p>SCREWS INCLUDED IN BASIC SET ONLY AVAILABLE IN PAINTED FINISH H=278 B=74 D=30.5</p>	<p>062.7862.PA DEURKRUK BINNEN BEQUILLE INTERIEURE DOOR HANDLE INSIDE TUERDRUECKER INNEN</p> <p>X=69 Y=40 Z=80</p>	<p>CP 155-LS 006.2340.XX</p> <p>CP 155-LS/AP 006.2344.XX</p> <p>CP 96-LS CP 96-LS/AP CP 130-LS</p> <p>TLS 110</p>	
 <p>SCREWS INCLUDED IN BASIC SET 062.6800.-- (LS 300kg) ONLY AVAILABLE IN PAINTED FINISH H=278 B=74 D=30.5</p>	<p>062.7865.PA DEURKRUK BEQUILLE DOOR HANDLE TUERDRUECKER</p> <p>X=69 Y=40 Z=80</p>	<p>CP 155-LS 006.2340.XX 006.2344.XX</p> <p>CP 96-LS CP 96-LS/AP</p> <p>TLS 110 CP 130-LS CP 155-LS/AP</p>	
 <p>062.6800.-- OR 062.6799.--(LS) SCREWS INCLUDED IN BASIC SET 062.6858.-- ONLY AVAILABLE IN PAINTED FINISH</p>	<p>062.7872.PA KOMGREEP BUITEN POIGNEE A CUVETTE EXTERIEURE CUP HANDLE OUTSIDE SCHALENGRIFF AUSSEN</p> <p>H=150 B=14 B= 35</p>	<p>CP 155-LS 006.2440.XX</p> <p>CP 155-LS/AP 006.2444.XX</p> <p>CP 96-LS CP 96-LS/AP CP 130-LS</p> <p>TLS 110</p>	

 <p> SCREWS INCLUDED IN BASIC SET ONLY AVAILABLE IN PAINTED FINISH</p>	<p>062.7863.PA</p> <p>DEURKRUK BUITEN BEQUILLE EXTERIEURE DOORHANDLE OUTSIDE TUERDRUECKER AUSSEN</p>	<p></p> <p>CP 155-LS 006.2340.XX 006.2344.XX</p> <p>CP 155-LS/AP 006.2344.XX</p> <p>CP 96-LS CP 96-LS/AP CP 130-LS</p> <p>TLS 110</p>		
 <p> SCREWS INCLUDED IN BASIC SET ONLY AVAILABLE IN PAINTED FINISH</p>	<p>062.7864.PA</p> <p>DEURKRUK BEQUILLE DOOR HANDLE TUERDRUECKER</p> <p>X=69 Y=40 Z=80</p>	<p></p> <p>CP 155-LS 006.2340.XX 006.2344.XX</p> <p>CP 155-LS/AP 006.2344.XX</p> <p>CP 96-LS CP 96-LS/AP CP 130-LS</p> <p>TLS 110</p>		
 <p> H=153 B=13 D=31</p>	<p>062.7952.PA</p> <p>AFDEKKAP CAPUCHON FACE CAP ABDECKKAPPE</p>	<p>TLS 110 CP 130-LS CP 155-LS CP 96-LS</p>		
 <p> H=153 B=13 D=31</p>	<p>062.7953.PA</p> <p>AFDEKKAP CAPUCHON FACE CAP ABDECKKAPPE</p>	<p>TLS 110 CP 130-LS CP 155-LS CP 96-LS</p>		

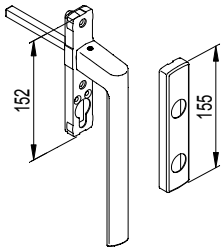
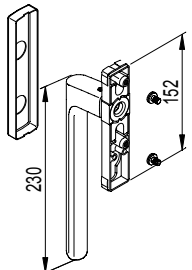
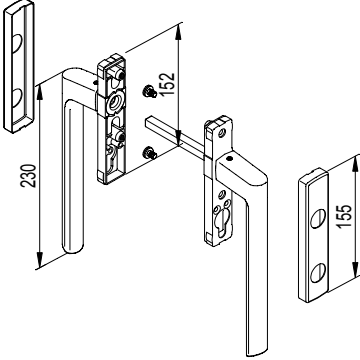
 <p>SCREWS INCLUDED IN BASIC SET (LS 300kg) ONLY AVAILABLE IN PAINTED FINISH H=278 B=74 D= 30.5</p>	<p>062.7963.PA</p> <p>DEURKRUK BINNEN KABA BEQUILLE INTERIEURE KABA DOOR HANDLE INSIDE KABA TUERDRUECKER INNEN KABA</p> <p>X=70 Y=40 Z=80</p>	<p>CP 155-LS 006.2340.XX 006.2344.XX</p> <p>CP 130-LS CP 155-LS/AP</p> <p>TLS 110</p>		
 <p>SCREWS INCLUDED IN BASIC SET (LS 300kg) ONLY AVAILABLE IN PAINTED FINISH H=278 B=74 D=30.5</p>	<p>062.7964.PA</p> <p>DEURKRUK BUITEN KABA BEQUILLE EXTERIEURE KABA DOORHANDLE OUTSIDE KABA TUERDRUECKER AUSSEN KABA</p> <p>X=70 Y=40 Z=80</p>	<p>CP 155-LS 006.2340.XX 006.2344.XX</p> <p>CP 130-LS CP 155-LS/AP</p> <p>TLS 110</p>		
 <p>SCREWS INCLUDED IN BASIC SET (LS 300kg) ONLY AVAILABLE IN PAINTED FINISH H=278 B=74 D=30.5</p>	<p>062.7965.PA</p> <p>DEURKRUK KABA BEQUILLE KABA DOOR HANDLE KABA TUERDRUECKER KABA</p> <p>X=70 Y=40 Z=80</p>	<p>CP 155-LS 006.2340.XX 006.2344.XX</p> <p>CP 130-LS CP 155-LS/AP</p> <p>TLS 110</p>		
<p> </p>				









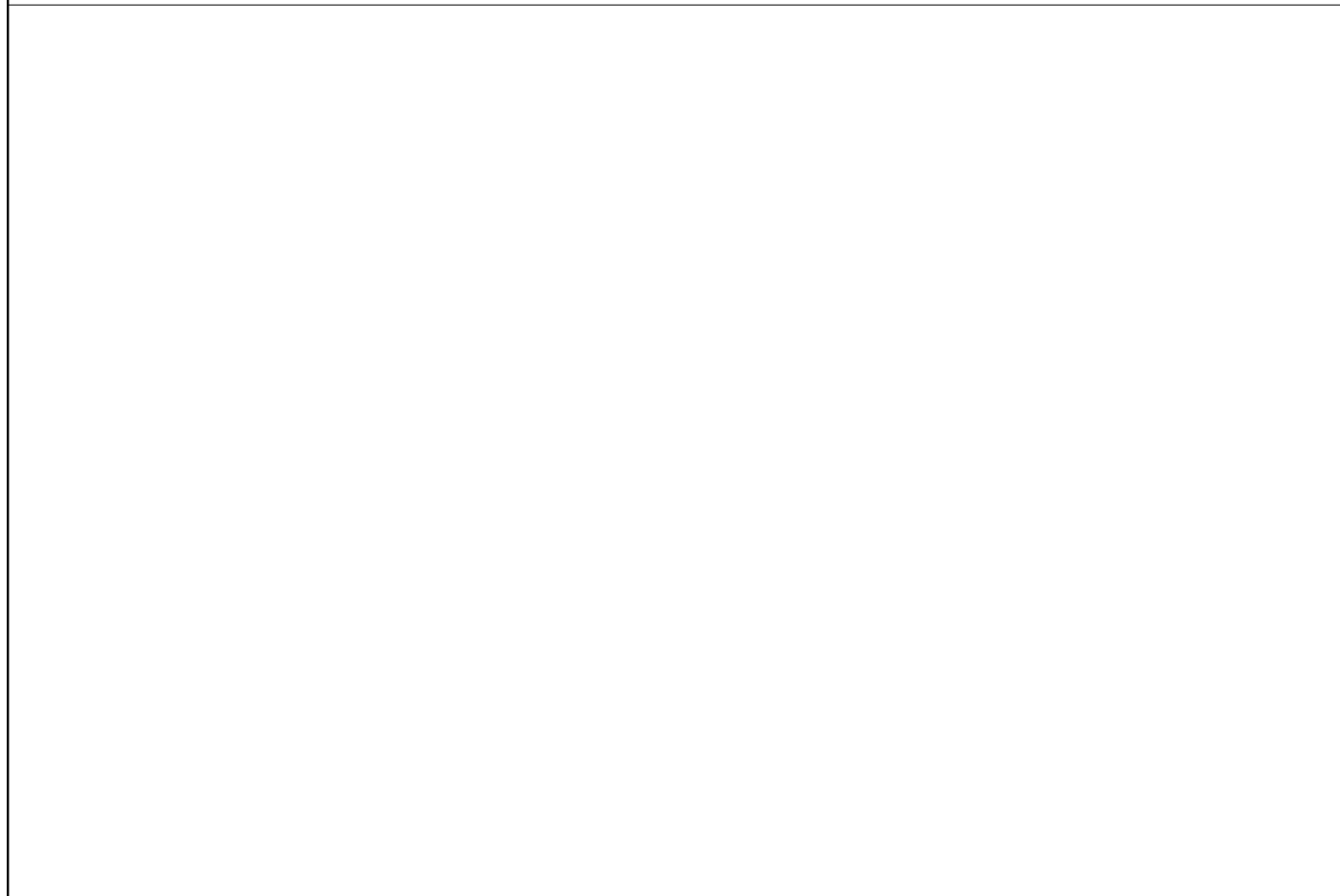

 	<p>061.7098.--</p> <p>VIERKANTSTIFT 8MM L=139MM TIGE 8MM L=139MM SPINDLE 8MM L=139MM DRUCKERSTIFT 8MM L=139MM</p>	 <p>CS 59Pa CS 59 CS 68 CP 155 CS 77 CS 77-BP Eco system CF 77 CS 77-SP CF 77-AP</p>		
--	--	---	--	--

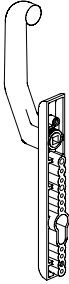

 <p>H=220 - B=50 - D=47 ONLY AVAILABLE IN PAINTED FINISH</p>	<p>062.7750.PA HANDGREEP BINNEN MAIN COURANTE INTERIEURE HANDRAIL INSIDE HANDLAUF INNEN</p>	<p>CP 155 006.2340.XX 006.2344.XX</p> <p>CP 130 CP 155-AP</p>	<p> 2 st./pc 057.5711.--  M5</p> <p> 2 st./pc 050.5011.--  DIN 965 M5 x 20</p>
--	--	--	---

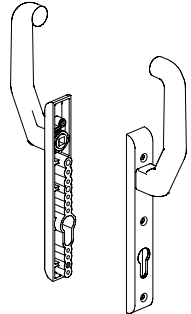
 <p>H=220 - B=50 - D=47 ONLY AVAILABLE IN PAINTED FINISH</p>	<p>062.7752.PA HANDGREEP BINNEN MAIN COURANTE INTERIEURE HANDRAIL INSIDE HANDLAUF INNEN</p>	<p>CP 155 006.2340.XX 006.2344.XX</p> <p>CP 130 CP 155-AP</p>	<p> 2 st./pc 057.5711.--  M5</p> <p> 2 st./pc 050.5011.--  DIN 965 M5 x 20</p>
---	--	--	---

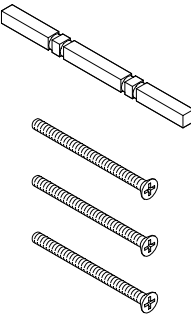

 <p>ONLY AVAILABLE IN PAINTED FINISH !062.8445->CP 96-AP!062.8433->CP 155-AP H=206.5 B=68.5 D=26.5</p>	<p>062.8431.PA DEURKRUK SOFTLINE BUITEN BEQUILLE SOFTLINE EXTERIEURE DOOR HANDLE SOFTLINE OUTSIDE TUERDRUECKER SOFTLINE AUSSEN</p> <p>S=88 X=92 Y=21.5 Z=73.5</p>	<p>CP 155-AP CP 96-AP</p>		<p> 1 st./pc 062.8433.--  SET -  1 st./pc 062.8445.--  SET -</p>
 <p>ONLY AVAILABLE IN PAINTED FINISH !062.8445->CP 96-AP!062.8433->CP 155-AP H=206.5 B=68.5 D=26.5</p>	<p>062.8432.PA DEURKRUK LANGE ROZET BEQUILLE ROSACE ALLONGEE DOOR HANDLE WITH LONG COVER PLATE TUERDRUECKER MIT LANGSCHILD</p> <p>S=88 X=92 Y=21.5 Z=73.5</p>	<p>CP 155-AP CP 96-AP</p>		<p> 1 st./pc 062.8433.--  SET -  1 st./pc 062.8445.--  SET -</p>
 <p>H=8 B=136 D=8</p>	<p>062.8433.-- SET STIFT + SCHROEVEN M6x85MM SET TIGE + VIS M6x85MM SET SPINDLE + SCREWS M6x85MM SATZ STIFT + SCHRAUBEN M6x85MM</p>	<p>CP 155-AP</p>		

CP 155-AP CP 155-LS/AP

INBRAAKWEREND
PROTECTION ANTI-VOL
BURGLAR PROTECTION
EINBRUCHHEMMEND

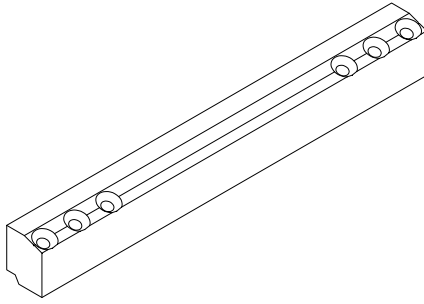

062.8424.XX

INBRAAKBEVEILIGING
PIECE D'ANTI-VOL
SECURITY DEVICE
EINBRUCHSICHERUNG

CP 155-AP
CP 155-LS/AP



4 st./pc
052.5318.--

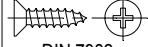

DIN 7982
4.2 x 38

H=21
B=16.5
D=180

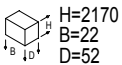
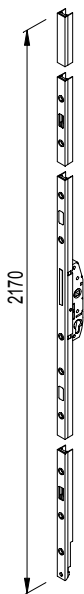
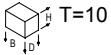
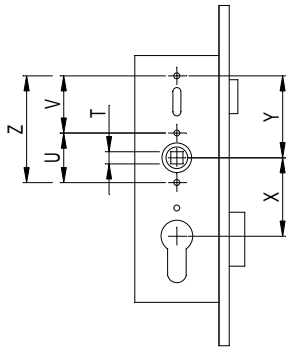

062.7961.ZC

2-PUNTSLUITING H=2170MM KABA
 FERMETURE A 2 POINTS H=2170MM KABA
 2-POINT LOCK H=2170MM KABA
 2-FACHVERRIEGELUNG H=2170MM KABA



CP 155-LS
 006.2340.XX

CP 155-LS/AP
 006.2344.XX

CP 130-LS

TLS 110

U=80 X=71

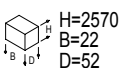
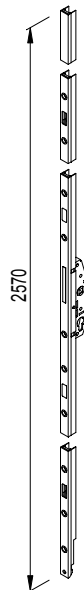

062.7962.ZC

2-PUNTSLUITING H=2570MM KABA
 FERMETURE A 2 POINTS H=2570MM KABA
 2-POINT LOCK H=2570MM KABA
 2-FACHVERRIEGELUNG H=2570MM KABA



CP 155-LS
 006.2340.XX

CP 155-LS/AP
 006.2344.XX

CP 130-LS

TLS 110

U=80 X=71

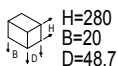
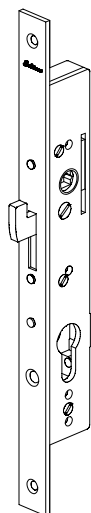
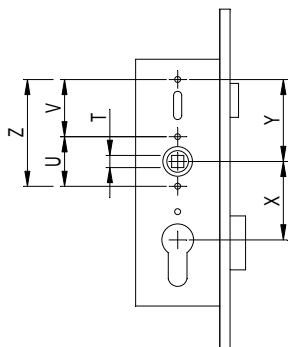

062.8425.ZC

HAAKSLOT
SERRURE A CROCHET
HOOK LOCK
HAKENSCHLOSS



CP 155
006.2340.XX

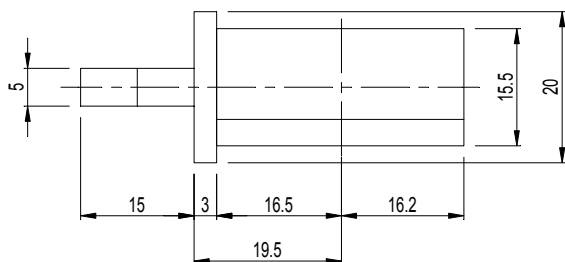
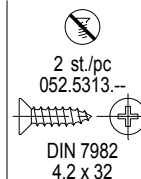

X=92 Y=21.5 Z=73.5

062.8426.ZC

5-PUNTSLUITING
FERMETURE A 5 POINTS
5-POINT LOCK
5-FACHVERRIEGELUNG







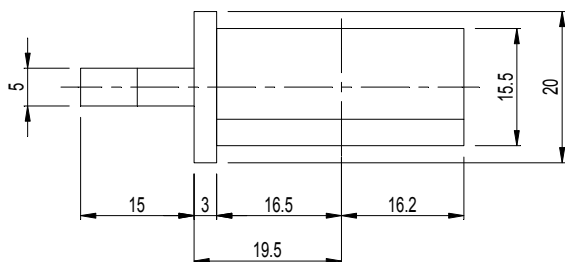
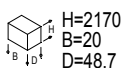
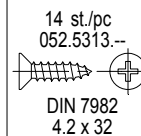







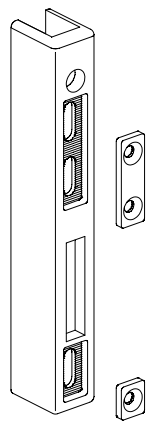

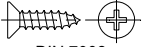
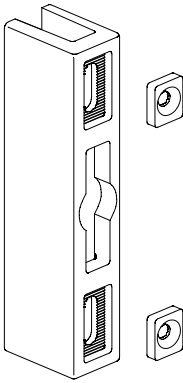

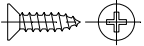
CP 155
006.2340.XX

CP 155-AP
006.2344.XX

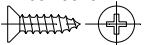

X=92 Y=21.5 Z=73.5

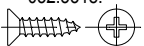
	  			
 <p data-bbox="135 638 263 705">  H=136 B=22.5 D=18 </p>	<p data-bbox="606 268 766 302">062.8434.--</p> <p data-bbox="606 313 845 414"> SLOTPAD B=22.5MM GACHE B=22.5MM RECEIVER B=22.5MM SCHLISSBLECH B=22.5MM </p>	<p data-bbox="1133 268 1228 302">CP 155</p>		<p data-bbox="1428 280 1476 313"></p> <p data-bbox="1396 324 1508 369">3 st./pc 052.5318.--</p> <p data-bbox="1380 369 1524 414"></p> <p data-bbox="1412 414 1492 459">DIN 7982 4.2 x 38</p>
 <p data-bbox="135 1097 263 1164">  H=80.5 B=26 D=18 </p>	<p data-bbox="606 728 766 761">062.8438.--</p> <p data-bbox="606 772 829 873"> SLOTPAD B=26MM GACHE B=26MM RECEIVER B=26MM SCHLISSBLECH B=26MM </p>	<p data-bbox="1133 728 1228 761">CP 155</p>		<p data-bbox="1428 739 1476 772"></p> <p data-bbox="1396 784 1508 828">2 st./pc 052.5318.--</p> <p data-bbox="1380 828 1524 873"></p> <p data-bbox="1412 873 1492 918">DIN 7982 4.2 x 38</p>
 <p data-bbox="135 1556 263 1624">  H=2180 B=23 D=20 </p>	<p data-bbox="606 1187 782 1220">062.8440.XX</p> <p data-bbox="606 1232 813 1332"> SLUITLAT B=23MM TRINGLE B=23MM LINK BAR B=23MM SCHUBSTANGE B=23MM </p>	<p data-bbox="1125 1198 1236 1254">CP 155 CP 155-AP</p>		<p data-bbox="1428 1198 1476 1232"></p> <p data-bbox="1396 1243 1508 1288">12 st./pc 052.5318.--</p> <p data-bbox="1380 1288 1524 1332"></p> <p data-bbox="1412 1332 1492 1377">DIN 7982 4.2 x 38</p>
 <p data-bbox="135 2016 263 2083">  H=2170 B=28 D=25 </p>	<p data-bbox="606 1646 782 1680">062.8441.XX</p> <p data-bbox="606 1691 813 1792"> SLUITLAT B=28MM TRINGLE B=28MM LINK BAR B=28MM SCHUBSTANGE B=28MM </p>	<p data-bbox="1125 1657 1236 1713">CP 155 CP 155-AP</p>		<p data-bbox="1428 1657 1476 1691"></p> <p data-bbox="1396 1702 1508 1747">12 st./pc 052.5318.--</p> <p data-bbox="1380 1747 1524 1792"></p> <p data-bbox="1412 1792 1492 1836">DIN 7982 4.2 x 38</p>

CP 155 CP 155-LS

CILINDER
CYLINDRE
CYLINDER
ZYLINDER

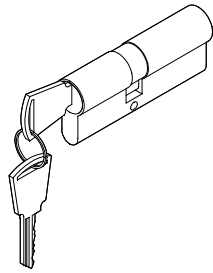
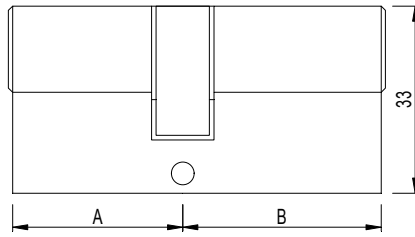
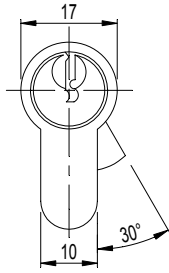

H=33
B=17
D=95

061.7038.--

CILINDER 95MM A=40 B=55
CYLINDRE 95MM A=40 B=55
CYLINDER 95MM A=40 B=55
ZYLINDER 95MM A=40 B=55



CP 155
CP 155-LS

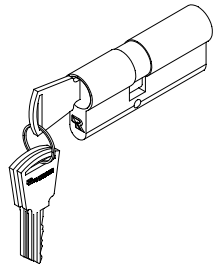

H=33
B=17
D=70





061.7044.--

CILINDER 70MM A=30 B=40
CYLINDRE 70MM A=30 B=40
CYLINDER 70MM A=30 B=40
ZYLINDER 70MM A=30 B=40



CS 59Pa
CS 59
CS 68
CP 155
CP 155-LS
CS 77
Eco system

D00014025

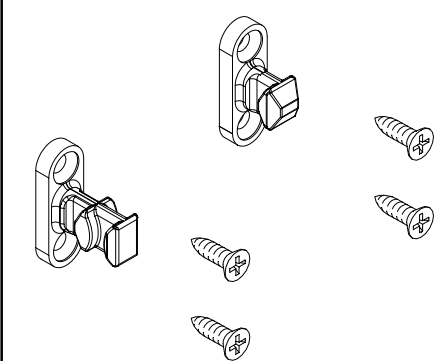
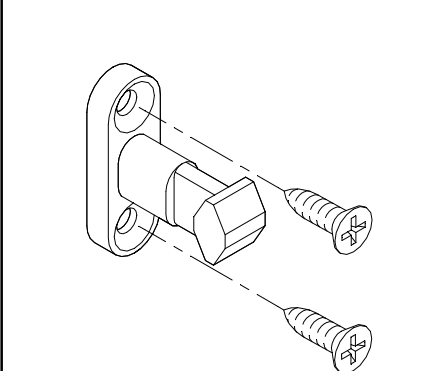
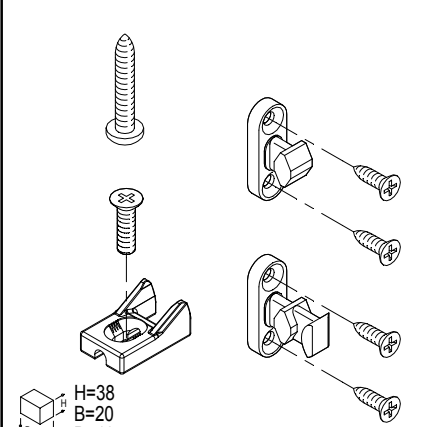
	  			
	<p>062.6940.-- EXTRA SLUITSTUK GACHE SUPPLEMENTAIRE EXTRA ADJUSTING LOCK PLATE ZUSAETZLICHES SCHLISSSTUECK</p>	<p>CP 130-LS CP 155-LS</p>		
 <p>H= 23 B= 38 D= 13</p>	<p>062.7869.-- BIJKOMEND SLOT PAD GACHE SUPPLEMENTAIRE SUPPLEMENTARY RECEIVER ZUSAETZLICHES SCHLISSBLECH</p>	<p>CP 155-LS CP 155-LS/AP</p>		
 <p>H=38 B=20 D=13</p>	<p>062.7871.-- SET TOEBEHOREN 4-SLAG SET ACCESSOIRES 4 VANTAUX ACCESSORIES SET 4 DOORS SATZ ZUBEHOER 4 TUERFLUEGEL</p>	<p>CP 155-LS</p>		



062.7867.--

BASISSET HEFSCHUIFDEUR FG=MAX300KG
 SET DE BASE SOULEV. COULISSANT FG=MAX300KG
 BASIC SET LIFT AND SLIDING DOOR FG=MAX300KG
 GRUNDKARTON HEBESCHIEBETUER FG=MAX300KG

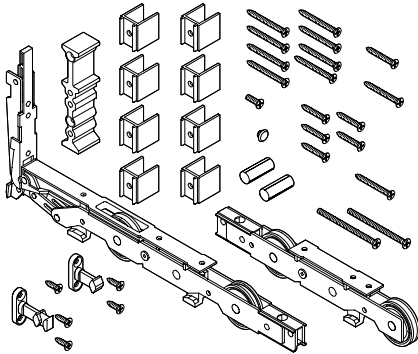

CP 155-LS

062.7903.--

LOOPWAGEN FG=MIN.300KG-MAX.400KG
 ROULETTES FG=MIN.300KG-MAX.400KG
 ROLLERS FG=MIN.300KG-MAX.400KG
 LAUFWAGEN FG=MIN.300KG-MAX.400KG

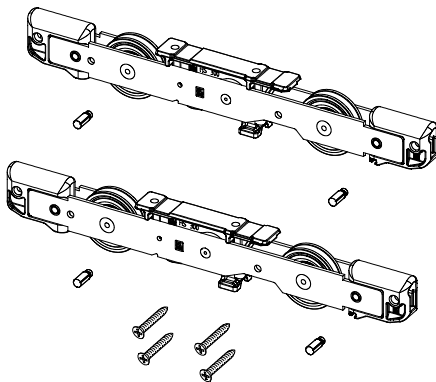

CP 155-LS



062.7868.ZC

2-PUNTSLUITING H=2570MM
 FERMETURE A 2 POINTS H=2570MM
 2-POINT LOCK H=2570MM
 2-FACHVERRIEGELUNG H=2570MM



CP 96-LS
 CP 96-LS/AP

CP 155-LS
 006.2340.XX

CP 155-LS/AP
 006.2344.XX

CP 130-LS
 TLS 110

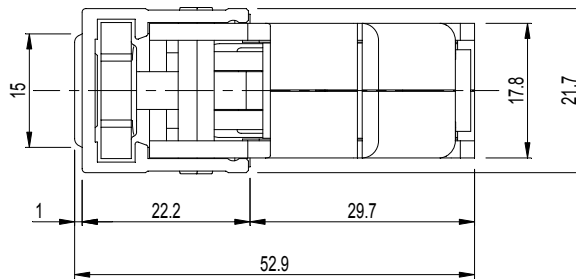
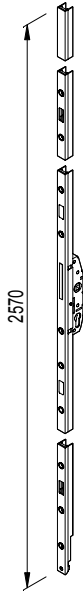

!050.5503 ->CP 96-LS/AP
 !050.5504 ->CP 96-LS
 H=2570 (LS 300kg) B=22 D=52

U=80 X=69

062.7902.ZC

2-PUNTSLUITING H=2170MM
 FERMETURE A 2 POINTS H=2170MM
 2-POINT LOCK H=2170MM
 2-FACHVERRIEGELUNG H=2170MM



CP 96-LS
 CP 96-LS/AP

CP 155-LS
 006.2340.XX

CP 155-LS/AP
 006.2344.XX

CP 130-LS
 TLS 110

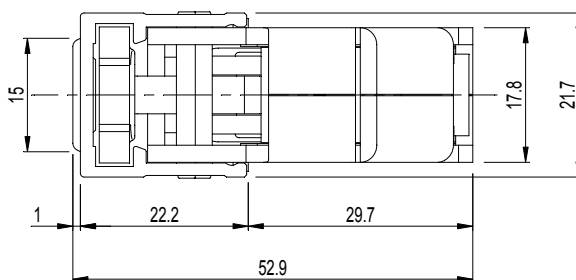
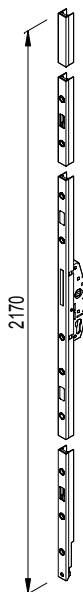

!050.5503 ->CP 96-LS/AP
 !050.5504 ->CP 96-LS
 H=2170 (LS 300kg) B=22 D=52

U=80 X=69



062.7937.--

VERLENGSTUK SLOT
RALLONGE SERRURE
LOCK EXTENSION
HAKENSCHLOSSVERLAENGERUNG

CP 155-LS

H=1224
B=23
D=22

CP 155 CP 155-LS

GLASSTEUN
SUPPORT CALE DE VITRAGE
GLASS SUPPORT
GLASAUFLAGEPROFIL

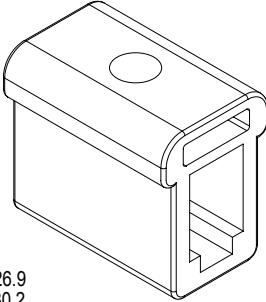
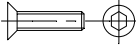
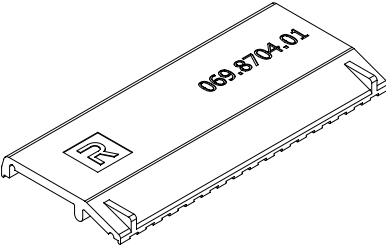
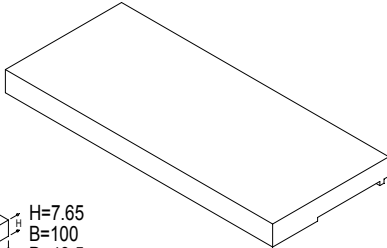
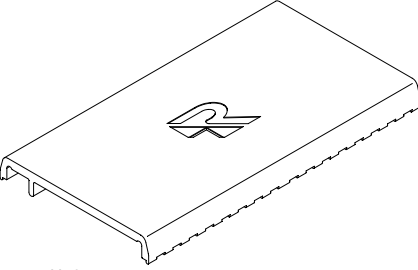

 <p>H=26.9 B=30.2 D=19.8</p>	<p>062.7800.04 GELEIDINGSSTUK PIECE DE GUIDAGE GUIDE BRACKET FUEHRUNGSTUECK</p>	<p>TLS 110 CP 130-LS CP 155-LS CP 155-LS/AP CP 96-LS</p>	<p>1 st./pc 050.5094.--  - M8 x 15</p>
 <p>H=6.6 B=44.5 D=100</p>	<p>069.8704.01 GLASSTEUN SUPPORT CALE DE VITRAGE GLASS SUPPORT GLASAUFLAGEPROFIL</p>	<p>CP 155 006.0320.XX 006.2340.XX 006.2344.XX 008.3114.XX 008.3120.XX 008.3123.XX 008.3824.XX 008.3848.XX 0K8.3824.XX CP 155-LS 006.0320.XX 006.0324.XX 006.0326.XX 006.1322.XX 006.2340.XX 006.2344.XX 008.3114.XX 008.3120.XX 008.3123.XX 008.3824.XX 008.3848.XX 0K8.3824.XX CP 155-AP 006.0320.XX</p>	<p>006.2340.XX 006.2344.XX CP 155-LS/AP 006.0320.XX 006.2340.XX 006.2344.XX CW 50 CW 50-HI CW 60 CS 77 CS 77-HV CS 77-BP CS 77-FP CW 60-DRL CS 77-Re CS 77-SP</p>
 <p>H=7.65 B=100 D=43.5</p>	<p>069.8724.04 GLASSTEUN FG=MIN250-MAX.400KG SUPPORT CALE DE VITRAGE FG=MIN250-MAX.400KG GLASS SUPPORT FG=MIN250-MAX.400KG GLASAUFLAGEPROFIL FG=MIN250-MAX.400KG</p>	<p>CP 155 006.2340.XX 006.2344.XX CP 155-LS 006.2340.XX 006.2344.XX CP 155-AP 006.2340.XX 006.2344.XX</p>	<p>006.2340.XX 006.2344.XX CP 155-LS/AP</p>
 <p>H=8 B=53.9 D=100</p>	<p>069.8748.01 GLASSTEUN SUPPORT CALE DE VITRAGE GLASS SUPPORT GLASAUFLAGEPROFIL</p>	<p>CP 155-LS 006.0321.XX 006.0323.XX 006.0327.XX 006.0350.XX CS 77-FP CS 86-HI CF 77 CF 77-AP CS 77</p>	

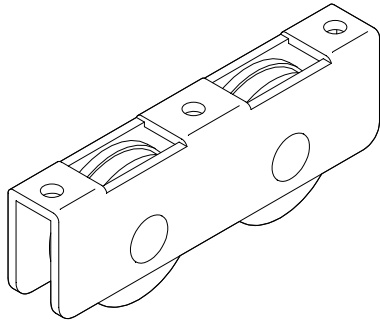

062.7834.--

DUBBEL WIEL FG=MAX.250KG
ROULETTE DOUBLE FG=MAX.250KG
DOUBLE ROLLER FG=MAX.250KG
DOPPELTES LAUFRAD FG=MAX.250KG

CP 155
006.2340.XX

CP 155-AP
006.2344.XX

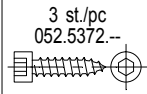

3 st./pc
052.5372.--







6.3 x 13

H=42
B=120
D=19

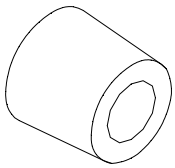
CP 155 CP 155-LS

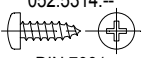
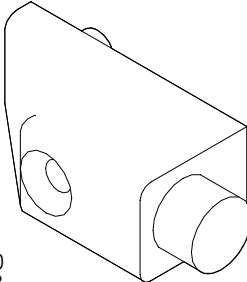
BUFFER
BUTEE
BUFFER
STOPPER

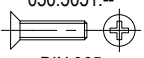

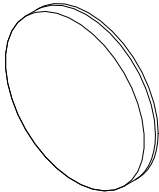





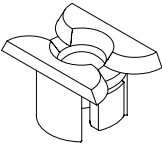

 <p>$\varnothing 16$ B=15</p>	<p>062.6744.04</p> <p>BUFFER BUTEE BUFFER STOPPER</p>	<p>CS 59Pa CS 59 CS 68 TP 110 TP 138 CP 130 CP 155-LS MOSQUITO CS 77 CP 96 CP 96-AP TP 110-Re CS 104</p>	 <p>1 st./pc 052.5314.--</p>  <p>DIN 7981 4.2 x 50</p>
 <p>H=20 B=53 D=25</p>	<p>062.7715.XX</p> <p>BUFFER BUTEE BUFFER STOPPER</p>	<p>VISION 50 TP 110 TP 138 TLS 110 CP 130 CP 130-LS CP 155 CP 155-LS CP 45Pa TP 110-Re CP 45Pa (GR)</p>	 <p>1 st./pc 050.5051.--</p>  <p>DIN 965 M6 x 30</p>
 <p>$\varnothing 12$</p>	<p>062.7717.04</p> <p>BUFFER BUTEE BUFFER STOPPER</p>	<p>VISION 50 TP 110 CP 130 CP 130-LS CP 155-LS TP 110-Re</p>	
 <p>$\varnothing 12.7$ D=1.3</p>	<p>062.7718.04</p> <p>BUFFER 1.3MM BUTEE 1.3MM BUFFER 1.3MM STOPPER 1.3MM</p>	<p>CP 130 CP 130-LS CP 155 CP 96 CP 96-AP</p>	

CP 155 CP 155-LS

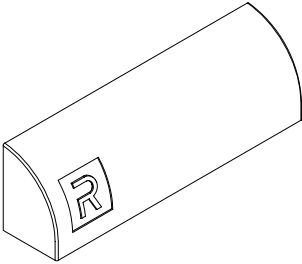
ALGEMENE TOEBEHOREN
ACCESSOIRES GENERAUX
GENERAL ACCESSORIES
ALLGEMEINES ZUBEHOER

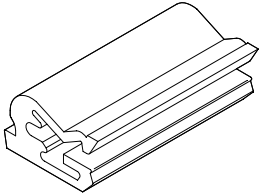

  B=7 D=10/13	<p>065.6555.04 STOP Ø10MM BOUHE-TROU Ø10MM PLUG Ø10MM VERSCHLUSSKAPPE Ø10MM</p>	CS 59Pa CS 59 CS 68 VISION 50 TP 110 TP 138 CP 130 CP 130-LS CP 155 CP 155-LS CW 60 TR 200 MOSQUITO	MEDAS CR 120 CS 77 CS 77-BP CS 38-SL CS 38-SL/AP PR 100 CW 60-HL CS 104
  H=9 B=18 D=12	<p>069.6747.04 VENTIEL CLAPET VALVE CAP VENTILKLAPPE</p>	CP 155 006.0320.XX CP 155-LS 006.0320.XX 006.0321.XX CP 155-AP 006.0320.XX CP 155-LS/AP 006.0320.XX	CP 130-LS CP 96-LS CP 96-AP CP 96-LS/AP TP 138 TLS 110 CP 96
  H=14 B=10 D=46	<p>069.6830.04 AFDEKKAP WATERAFVOERSLEUVEN CAPUCHON DRAINAGE D'EAU WEEP HOLE COVER ABDECKKAPPE ENTWAESSERUNG</p>	 CP 130 CP 45Pa CP 45Pa (GR) CP 155 CP 155-LS CP 96	
  H=8.5 B=17.8 D=30	<p>069.8422.04 KLIPS KUNSTSTOF CLIP MATIERE SYNTHETIQUE SYNTHETIC CLIP KUNSTSTOFF KLEMME</p>	CP 155 006.0320.XX CP 155-LS 006.0320.XX 006.0321.XX 006.0324.XX 006.1304.XX 006.1306.XX 006.1322.XX CP 155-AP 006.0320.XX CP 155-LS/AP 006.0320.XX 006.1304.XX CP 130 CP 130-LS CP 45Pa CP 45Pa (GR) CS 59Pa CS 59 CS 59-HV CS 59-Re	CS 59-So CS 68 CS 68-HV CS 68-Re CS 68-So TP 110 TP 138 TLS 110 MEDAS CS 77 CS 77-HV TP 110-Re CS 104 CI 45

CP 155 CP 155-LS

ALGEMENE TOEBEHOREN
ACCESSOIRES GENERAUX
GENERAL ACCESSORIES
ALLGEMEINES ZUBEHOER

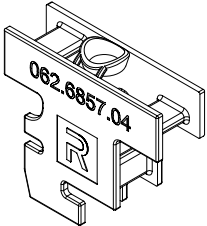
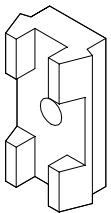
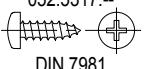
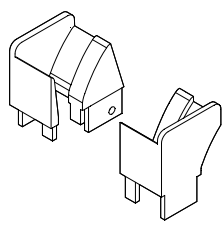
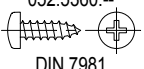

 <p>H=53 B=57.5 D=18</p>	<p>062.6857.04 AFDICHTINGSSTUK BUITENKADER PIECE D'ETANCHEITE DORMANT SEALING PIECE OUTERFRAME DICHTUNGSTUECK BLENDRAHMEN</p>	<p>CP 155 006.1300.XX 006.1400.XX CP 155-LS 006.1300.XX 006.1400.XX CP 155-AP 006.1300.XX CP 155-LS/AP 006.1300.XX</p>	
 <p>H=23 B=12 D=8</p>	<p>068.6351.04 KLEMSTUK CLIP CLIP BEFESTIGUNGSKLOTZ</p>	<p>Eco system CS 59Pa CS 59 CS 68 TP 110 TP 138 TLS 110 CP 130 CP 130-LS CP 155 CP 155-LS CS 77 REYNASCREEN Eco system-AP CS 104</p>	<p>st./pc 052.5317.-- DIN 7981 4.2 x 13</p> 
 <p>H=60 B=31.5 D=59.5</p>	<p>069.6761.04 INLOOPSTUK ROLLUIK PIECE D'ENTREE VOLET ENDS ROLLER SHUTTER ROLLADENEINLAUF</p>	<p>CP 155 004.3167.XX 030.1142.XX 030.1147.XX CP 155-LS 004.3167.XX 030.1142.XX 030.1147.XX CP 155-AP 030.1147.XX CP 155-LS/AP 030.1147.XX CS 59Pa CS 59 CS 68 TP 110 TP 138 TLS 110 CP 130 CP 130-LS CS 77 CS 59-AP CS 68-AP</p> <p>CS 77-AP CP 96 CP 96-LS CP 96-AP CP 96-LS/AP CS 68 Optima Eco system CS 86-HI Eco system-AP Eco system Optima CS 86-HI/AP CS 68 Optima-AP Eco system Optima-AP CS 104 CS 77 Optima CS 104-AP CS 59-HV CS 59-Re CS 59-So CS 68-HV CS 68-Re CS 68-So CS 77-HV</p>	<p>2 st./pc 052.5360.-- DIN 7981 4.2 x 9.5</p> 

CP 155 CP 155-LS

ALGEMENE TOEBEHOREN
ACCESSOIRES GENERAUX
GENERAL ACCESSORIES
ALLGEMEINES ZUBEHOER



<p>H=45 B=60 D=15</p>	<p>062.7894.04 SET AFSTANDSTUKKEN SET PIECES D'ECARTEMENT SET DISTANCE PIECES SET DISTANZSTUECKE</p>	<p>CP 155 006.2340.XX CP 155-LS 006.2340.XX CP 155-AP 006.2340.XX CP 155-LS/AP 006.2340.XX</p>	<p>2 st./pc 052.5317.-- DIN 7981 4.2 x 13</p>
<p>H=12.2 B=6.4 D=15</p>	<p>062.7927.04 AFSTANDSSTUK PIECE D'ECARTEMENT DISTANCE PIECE DISTANZSTUECK</p>	<p>CP 155 006.2340.XX CP 155-AP 006.2344.XX</p>	
<p>H=21.2 B=15 D=6.8</p>	<p>062.8045.04 AFSTANDSSTUK PIECE D'ECARTEMENT DISTANCE PIECE DISTANZSTUECK</p>	<p>CP 155-LS 006.2340.XX CP 155-LS/AP 006.2344.XX</p>	
<p>H=9.5 Ø=14</p>	<p>071.6554.SY AFDEKKAP CAPUCHON FACE CAP ABDECKKAPPE</p>	<p>TP 110 TLS 110 CP 130 CP 130-LS CP 155 CP 155-LS TR 200 CR 120 CP 155-AP CP 155-LS/AP CP 50 CP 96 CP 96-LS CP 96-AP CP 96-LS/AP MOOREA</p>	<p>TP 110-Re PR 100 CS 45Pa CP 50 (GR)</p>

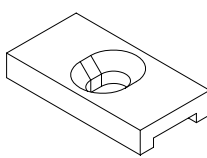
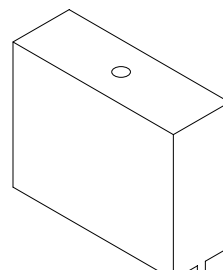
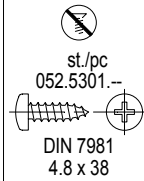
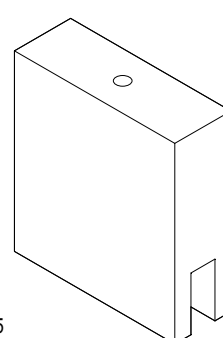
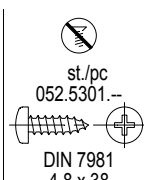

 <p>H=4 B=25 D=13</p>	<p>056.6209.04 STELBLOKJE CALE D'AJUSTEMENT ADJUSTING BLOCK DISTANZKLOTZ</p>	<p>TP 110 CP 45Pa (GR) TLS 110 CP 130 CP 130-LS CP 155 CP 155-LS TP 110-AP CP 155-AP CP 155-LS/AP CP 50 CP 96 CP 45Pa CP 96-LS CP 96-AP CP 96-LS/AP TP 110-Re</p>	
 <p>H=51 B=60 D=21</p>	<p>062.8038.07 STEUNSTUK VASTE VLEUGEL PIECE DE SUPPORT OUVRANT FIXE SUPPORTING PIECE FIXED FRAME STUETZKLOTZ FESTEN FLUEGEL</p>	<p>CP 155 006.2340.XX 006.2344.XX CP 155-LS 006.2340.XX 006.2344.XX CP 155-AP 006.2340.XX 006.2344.XX CP 155-LS/AP 006.2340.XX 006.2344.XX</p>	 <p>st./pc 052.5301.- DIN 7981 4.8 x 38</p>
 <p>H=65 B=60 D=21</p>	<p>062.8039.07 STEUNSTUK VASTE VLEUGEL PIECE DE SUPPORT OUVRANT FIXE SUPPORTING PIECE FIXED FRAME STUETZKLOTZ FESTEN FLUEGEL</p>	<p>CP 155 006.2340.XX 006.2344.XX CP 155-LS 006.2340.XX 006.2344.XX CP 155-AP 006.2340.XX 006.2344.XX CP 155-LS/AP 006.2340.XX 006.2344.XX</p>	 <p>st./pc 052.5301.- DIN 7981 4.8 x 38</p>
Empty row			



080.9123.SY

BINNENBEGLAZINGSDICHTING 3MM
JOINT DE VITRAGE INTERIEUR 3MM
INNER GLAZING GASKET 3MM
INNENVERGLASUNGSDICHTUNG 3MM

.04

.47

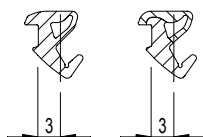

CS 59Pa	BOREALE	Eco system-AP
CS 59	MOSQUITO	CS 38-SL/AP
CS 59-HV	CS 77	CS 24-SL
CS 59-Re	CS 77-HV	Eco system 75
CS 59-So	CS 59Pa-AP	CS 104
CS 68	CS 59-AP	CP 45Pa (GR)
CS 68-HV	CS 68-AP	CS 77-SP
CS 68-Re	CS 77-AP	CI 45
CS 68-So	CS 77-BP	
VISION 50	CS 77-FP	
TP 110	CP 155-AP	
TP 138	CP 155-LS/AP	
TLS 110	CP 96	
CP 130	CP 45Pa	
CP 130-LS	CP 96-LS	
CP 155	CP 96-AP	
CP 155-LS	CP 96-LS/AP	
CW 50	TP 110-Re	
CW 60	Eco system	
TR 200	CS 38-SL	

H=8.9
B=7.7
COLOR= WHITE

080.9124.SY

BINNENBEGLAZINGSDICHTING 4MM
JOINT DE VITRAGE INTERIEUR 4MM
INNER GLAZING GASKET 4MM
INNENVERGLASUNGSDICHTUNG 4MM

.04

.47

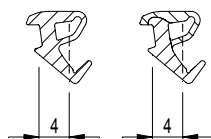

CS 59Pa	BOREALE	CS 38-SL/AP
CS 59	CS 77	CS 24-SL
CS 59-HV	CS 77-HV	Eco system 75
CS 59-Re	CS 59Pa-AP	CF 77
CS 59-So	CS 59-AP	CS 104
CS 68	CS 68-AP	CP 45Pa (GR)
CS 68-HV	CS 77-AP	CS 77-SP
CS 68-Re	CS 77-BP	CI 45
CS 68-So	CS 77-FP	CF 77-AP
VISION 50	CP 155-AP	
TP 110	CP 155-LS/AP	
TP 138	CP 96	
TLS 110	CP 45Pa	
CP 130	CP 96-LS	
CP 130-LS	CP 96-AP	
CP 155	CP 96-LS/AP	
CP 155-LS	TP 110-Re	
CW 50	Eco system	
CW 60	CS 38-SL	
TR 200	Eco system-AP	

H=8.7
B=9.6
COLOR= RED



080.9125.SY

BINNENBEGLAZINGSDICHTING 5MM
JOINT DE VITRAGE INTERIEUR 5MM
INNER GLAZING GASKET 5MM
INNENVERGLASUNGSDICHTUNG 5MM

.04 .47

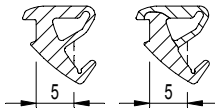

CS 59Pa	CS 77	CS 24-SL
CS 59	CS 77-HV	Eco system 75
CS 59-HV	CS 59Pa-AP	CF 77
CS 59-Re	CS 59-AP	CS 104
CS 59-So	CS 68-AP	CP 45Pa (GR)
CS 68	CS 77-AP	CS 77-SP
CS 68-HV	CS 77-BP	CI 45
CS 68-Re	CS 77-FP	CF 77-AP
CS 68-So	CP 155-AP	
VISION 50	CP 155-LS/AP	
TP 110	CP 96	
TP 138	CP 45Pa	
TLS 110	CP 96-LS	
CP 130	CP 96-AP	
CP 130-LS	CP 96-LS/AP	
CP 155	TP 110-Re	
CP 155-LS	Eco system	
CW 50	CS 38-SL	
CW 60	Eco system-AP	
TR 200	CS 38-SL/AP	

H=10.3
B=9.7
COLOR= BLUE

080.9126.SY

BINNENBEGLAZINGSDICHTING 6-7MM
JOINT DE VITRAGE INTERIEUR 6-7MM
INNER GLAZING GASKET 6-7MM
INNENVERGLASUNGSDICHTUNG 6-7MM

.04 .47

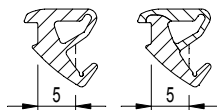

CS 59Pa	CS 77	CS 24-SL
CS 59	CS 77-HV	Eco system 75
CS 59-HV	CS 59Pa-AP	CF 77
CS 59-Re	CS 59-AP	CS 104
CS 59-So	CS 68-AP	CP 45Pa (GR)
CS 68	CS 77-AP	CS 77-SP
CS 68-HV	CS 77-BP	CI 45
CS 68-Re	CS 77-FP	CF 77-AP
CS 68-So	CP 155-AP	
VISION 50	CP 155-LS/AP	
TP 110	CP 96	
TP 138	CP 96-LS	
TLS 110	CP 96-AP	
CP 130	CP 96-LS/AP	
CP 130-LS	TP 110-Re	
CP 155	Eco system	
CP 155-LS	CS 38-SL	
CW 50	CS 86-HI	
CW 60	Eco system-AP	
TR 200	CS 38-SL/AP	

H=11.5
B=11.4
COLOR= GREEN



080.9128.04

BINNENBEGLAZINGSDICHTING 8-9MM
JOINT DE VITRAGE INTERIEUR 8-9MM
INNER GLAZING GASKET 8-9MM
INNENVERGLASUNGSDICHTUNG 8-9MM

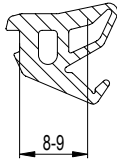

CS 59Pa	CS 77	CF 77
CS 59	CS 77-HV	CS 104
CS 59-HV	CS 59Pa-AP	CS 77-SP
CS 59-Re	CS 59-AP	CI 45
CS 59-So	CS 68-AP	CF 77-AP
CS 68	CS 77-AP	
CS 68-HV	CS 77-BP	
CS 68-Re	CP 155-AP	
CS 68-So	CP 155-LS/AP	
VISION 50	CP 96	
TP 110	CP 96-LS	
TP 138	CP 96-AP	
TLS 110	CP 96-LS/AP	
CP 130	TP 110-Re	
CP 130-LS	Eco system	
CP 155	CS 38-SL	
CP 155-LS	Eco system-AP	
CW 50	CS 38-SL/AP	
CW 60	CS 24-SL	
TR 200	Eco system 75	

H=13.4
B=14.8
COLOR= YELLOW

080.9130.04

BINNENBEGLAZINGSDICHTING 10MM
JOINT DE VITRAGE INTERIEUR 10MM
INNER GLAZING GASKET 10MM
INNENVERGLASUNGSDICHTUNG 10MM

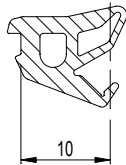

CS 59Pa	CS 77	Eco system 75
CS 59	CS 77-HV	CF 77
CS 59-HV	CS 59Pa-AP	CS 104
CS 59-Re	CS 59-AP	CS 77-SP
CS 59-So	CS 68-AP	CI 45
CS 68	CS 77-AP	CF 77-AP
CS 68-HV	CS 77-BP	
CS 68-Re	CP 155-AP	
CS 68-So	CP 155-LS/AP	
VISION 50	CP 96	
TP 110	CP 45Pa	
TP 138	CP 96-LS	
TLS 110	CP 96-AP	
CP 130	CP 96-LS/AP	
CP 130-LS	TP 110-Re	
CP 155	Eco system	
CP 155-LS	CS 38-SL	
CW 50	Eco system-AP	
CW 60	CS 38-SL/AP	
TR 200	CS 24-SL	

H=13.4
B=15.8
COLOR= VIOLET



080.9114.SY

BUITENBEGLAZINGSDICHTING 4MM
JOINT DE VITRAGE EXTERIEUR 4MM
OUTER GLAZING GASKET 4MM
AUSSENVERGLASUNGSDICHTUNG 4MM

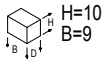
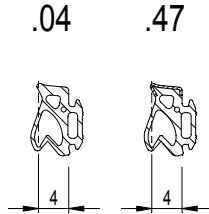

CS 59Pa	CP 155-AP
CS 59	CP 155-LS/AP
CS 59-Re	CP 96
CS 59-So	CP 45Pa
CS 68	CP 96-LS
CS 68-Re	CP 96-AP
CS 68-So	CP 96-LS/AP
VISION 50	TP 110-Re
TP 110	Eco system
TP 138	CS 38-SL
TLS 110	Eco system-AP
CP 130	CS 38-SL/AP
CP 130-LS	CS 24-SL
CP 155	CS 24-SL/AP
CP 155-LS	Eco system 75
CR 120	CF 77
CS 77	CS 104
CS 59-AP	CP 45Pa (GR)
CS 68-AP	CS 77-SP
CS 77-AP	CI 45
CS 77-BP	CF 77-AP
CS 77-FP	

080.9116.04

BUITENBEGLAZINGSDICHTING 6MM
JOINT DE VITRAGE EXTERIEUR 6MM
OUTER GLAZING GASKET 6MM
AUSSENVERGLASUNGSDICHTUNG 6MM

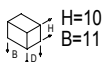
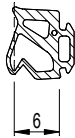

CS 59Pa	CP 155-LS/AP
CS 59	CP 96
CS 59-Re	CP 45Pa
CS 59-So	CP 96-LS
CS 68	CP 96-AP
CS 68-Re	CP 96-LS/AP
CS 68-So	TP 110-Re
VISION 50	Eco system
TP 110	CS 38-SL
TP 138	Eco system-AP
TLS 110	CS 38-SL/AP
CP 130	CS 24-SL
CP 130-LS	CS 24-SL/AP
CP 155	Eco system 75
CP 155-LS	CF 77
CR 120	CS 104
CS 77	CP 45Pa (GR)
CS 59-AP	CS 77-SP
CS 68-AP	CI 45
CS 77-AP	CF 77-AP
CS 77-BP	
CP 155-AP	

080.9118.04

BUITENBEGLAZINGSDICHTING 8MM
JOINT DE VITRAGE EXTERIEUR 8MM
OUTER GLAZING GASKET 8MM
AUSSENVERGLASUNGSDICHTUNG 8MM

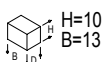
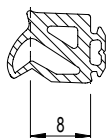

CS 59Pa	CP 155-LS/AP
CS 59	CP 96
CS 59-Re	CP 96-LS
CS 59-So	CP 96-AP
CS 68	CP 96-LS/AP
CS 68-Re	TP 110-Re
CS 68-So	Eco system
VISION 50	CS 38-SL
TP 110	Eco system-AP
TP 138	CS 38-SL/AP
TLS 110	Eco system 75
CP 130	CF 77
CP 130-LS	CS 104
CP 155	CS 77-SP
CP 155-LS	CI 45
CR 120	CF 77-AP
CS 77	
CS 59-AP	
CS 68-AP	
CS 77-AP	
CS 77-BP	
CP 155-AP	

CP 155 CP 155-LS

BEGLAZINGSDICHTINGEN
JOINTS DE VITRAGE
GLAZING GASKETS
VERGLASUNGSDICHTUNGEN



080.9120.04

BUITENBEGLAZINGSDICHTING 10MM
JOINT DE VITRAGE EXTERIEUR 10MM
OUTER GLAZING GASKET 10MM
AUSSENVERGLASUNGSDICHTUNG 10MM

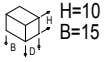
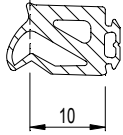









CS 59Pa	CP 155-LS/AP
CS 59	CP 96
CS 59-Re	CP 96-LS
CS 59-So	CP 96-AP
CS 68	CP 96-LS/AP
CS 68-Re	TP 110-Re
CS 68-So	Eco system
VISION 50	CS 38-SL
TP 110	Eco system-AP
TP 138	CS 38-SL/AP
TLS 110	Eco system 75
CP 130	CF 77
CP 130-LS	CS 104
CP 155	CS 77-SP
CP 155-LS	CI 45
CR 120	CF 77-AP
CS 77	
CS 59-AP	
CS 68-AP	
CS 77-AP	
CS 77-BP	
CP 155-AP	

CP 155 CP 155-LS

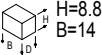
DICHTINGEN
JOINTS
GASKETS
DICHTUNGEN

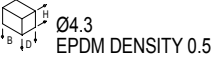

				
 	<p>080.9253.04 RUBBER MET UITZETVOEG JOINT DE DILATATION EXPANSION GASKET DICHTUNG MIT DEHNUNGSFUEGE</p>	<p>CP 155 030.3890.XX CP 155-LS 030.3890.XX CS 59 CS 68 TP 110 TLS 110 CP 130-LS CW 50 CS 77</p>	<p>CW 50-SC TP 110-Re Eco system Eco system-AP CP 130 CW 60 Eco system 75</p>	
 	<p>080.9381.04 DICHTING Ø4.3MM JOINT Ø4.3MM GASKET Ø4.3MM DICHTUNG Ø4.3MM</p>	<p>CP 155 006.1301.04 006.1342.XX CP 155-LS 006.1301.04 006.1304.XX 006.1306.XX 006.1342.XX 006.1406.XX CP 155-AP 006.1301.04 006.1342.XX CP 155-LS/AP 006.1301.04 006.1304.XX 006.1342.XX CS 59 CW 50 CW 50-HI CW 50-HL CW 50-RA CW 60 CW 50-SC CW 50-SG CW 60-SG CW 50-SL Eco system Eco system-AP CS 24-SL CW 60-SC CW 60-HI CW 60-HL CS 24-SL/AP CW 65-EF CW 65-EF/SG CW 65-EF/HI</p>	<p>CS 59Pa CS 59-HV CS 59-Re CS 59-So CS 68 CS 68-HV CS 68-Re CS 68-So VISION 50 TP 110 TP 138 TLS 110 CP 130 CP 130-LS TR 200 BOREALE CR 120 CS 77 CW 86 CS 77-HV CS 77-FP CP 96 CP 45Pa CW 86-EF CP 96-LS TP 110-Re CS 38-SL CS 86-HI CS 38-SL/AP PR 100 Eco system 75 CS 104 CS 77-SP CI 45</p>	
	<p>080.9424.04 DICHTING EPDM JOINT EPDM GASKET EPDM DICHTUNG EPDM</p>	<p>CP 155 006.2340.XX 006.2344.XX CP 155-LS 006.2340.XX 006.2344.XX CP 155-AP 006.2340.XX 006.2344.XX CP 155-LS/AP</p>	<p>006.2340.XX 006.2344.XX</p>	

CP 155 CP 155-LS

DICHTINGEN
JOINTS
GASKETS
DICHTUNGEN

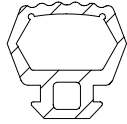

080.9430.04

AANSLAGDICHTING
JOINT DE BUTEE
BUTT STRIP
ANSCHLAGDICHTUNG

CP 155
006.1300.XX
006.1400.XX

CP 155-LS
006.1300.XX
006.1400.XX

CP 155-AP
006.1300.XX

CP 155-LS/AP
006.1300.XX

TP 110
CP 130
CW 50
CW 60
TR 200
CR 120
CP 96-LS
CP 96-LS/AP
TP 110-Re
Eco system
Eco system-AP

H=7.7
B=8

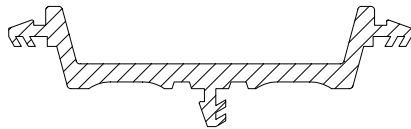

080.9441.04

DICHTING
JOINT
GASKET
DICHTUNG

CP 155-LS
006.0317.XX
006.0318.XX

D00090492

CP 155-HI CP 155-LS/HI

DICHTINGEN
JOINTS
GASKETS
DICHTUNGEN

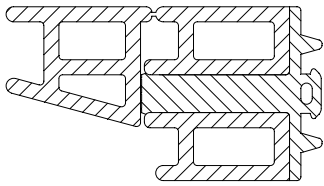
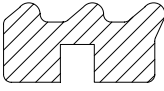
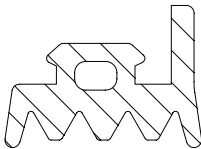

 <p>H=23 B=41.8</p>	<p>080.9439.04 ISOLATOR ISOLATEUR INSULATOR ISOLATOR</p>	<p>CP 155 006.2340.XX 006.2344.XX</p> <p>CP 155-LS 006.2340.XX 006.2344.XX</p> <p>CP 155-AP 006.2340.XX 006.2344.XX</p> <p>CP 155-LS/AP 006.2340.XX 006.2344.XX</p>		
 <p>H=10.5 B=20</p>	<p>080.9625.07 ISOLATIE DICHTING 10.5MM JOINT D'ISOLATION 10.5MM INSULATION GASKET 10.5MM ISOLATION DICHTUNG 10.5MM</p>	<p>CP 155 006.0320.XX 006.2340.XX 006.2344.XX</p> <p>CP 155-LS 006.0320.XX 006.0324.XX 006.0326.XX 006.1322.XX 006.2340.XX 006.2344.XX</p> <p>CP 155-AP 006.0320.XX 006.2340.XX 006.2344.XX</p> <p>CP 155-LS/AP 006.0320.XX 006.2340.XX 006.2344.XX</p>	<p>CP 130 CP 130-LS</p> <p>CS 68 CS 77 CF 77 CS 77-SP CF 77-AP</p>	
 <p>H=9.4 B=13</p>	<p>080.9815.SY BEGLAZINGSDICHTING 3.5MM JOINT DE VITRAGE 3.5MM GLAZING GASKET 3.5MM VERGLASUNGSDICHTUNG 3.5MM</p>	<p>CP 155 006.0320.XX</p> <p>CP 155-LS 006.0320.XX 006.0324.XX 006.0326.XX 006.1322.XX</p> <p>CP 155-AP 006.0320.XX</p> <p>CP 155-LS/AP 006.0320.XX</p> <p>CP 130 CP 130-LS CW 50 CW 60 CR 120 CW 65-EF CW 65-EF/HI</p>	<p>TP 110 TP 138</p> <p>CW 50-HL CW 50-RA CW 50-SC CW 50-SG CW 60-SG CW 50-SL CP 96 CP 96-AP CW 60-SC CW 60-HL</p>	

CP 155 CP 155-LS

AFDICHTINGEN
FERMETURES
END PIECES
ABDICHTUNGEN

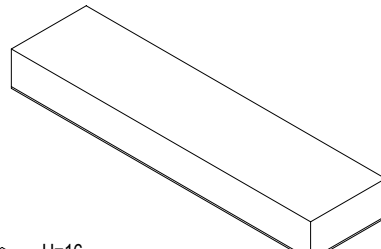
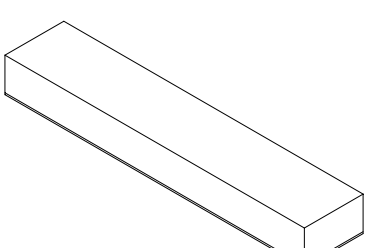
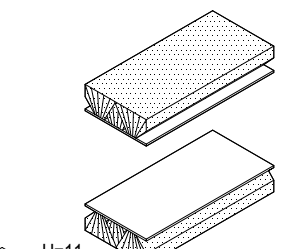
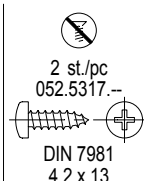
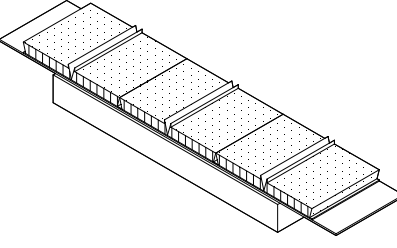
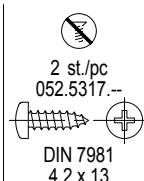
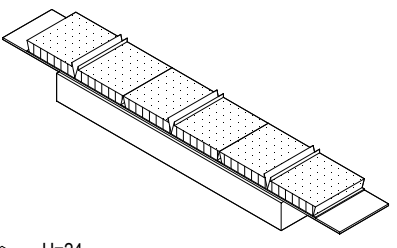
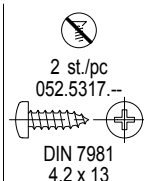

 <p>H=16 B=140 D=35</p>	<p>062.8011.04 AFDICHTING WISSELPROFIEL ONDER FERMETURE CHICANE EN BAS CLOSER MEETING SECTION BOTTOM ABDICHTUNG WECHSELPROFIL UNTEN</p>	<p>CP 155 006.1301.04 CP 155-LS 006.1301.04 CP 155-AP 006.1301.04 CP 155-LS/AP 006.1301.04</p>	
 <p>H=16 B=140 D=27.5</p>	<p>062.8012.04 AFDICHTING WISSELPROFIEL ONDER FERMETURE CHICANE EN BAS CLOSER MEETING SECTION BOTTOM ABDICHTUNG WECHSELPROFIL UNTEN</p>	<p>CP 155 006.0320.XX CP 155-LS 006.0320.XX CP 155-AP 006.0320.XX CP 155-LS/AP 006.0320.XX</p>	
 <p>H=11 B=29 D=50</p>	<p>062.8013.07 BORSTELDICHTING 4-SLAG JOINT-BROSSE 4 VANTAUX WOOLPILE 4 DOOR BUERSTENDICHTUNG STULPPROFIL</p>	<p>CP 155 006.0345.XX CP 155-LS 006.0345.XX CP 130</p>	<p> 2 st./pc 052.5317.-- DIN 7981 4.2 x 13</p>
 <p>H=24 B=210 D=45</p>	<p>062.8036.04 AFDICHTING MET BORSTEL FERMETURE AVEC BROSSE CLOSER WITH BRUSH ABDICHTUNG MIT BUERSTE</p>	<p>CP 155-LS 006.1303.04 CP 155-LS/AP 006.1303.04</p>	<p> 2 st./pc 052.5317.-- DIN 7981 4.2 x 13</p>
 <p>H=24 B=210 D=32.5</p>	<p>062.8037.04 AFDICHTING MET BORSTEL FERMETURE AVEC BROSSE CLOSER WITH BRUSH ABDICHTUNG MIT BUERSTE</p>	<p>CP 155-LS 006.1322.XX</p>	<p> 2 st./pc 052.5317.-- DIN 7981 4.2 x 13</p>

CP 155 CP 155-LS

AFDICHTINGEN
FERMETURES
END PIECES
ABDICHTUNGEN

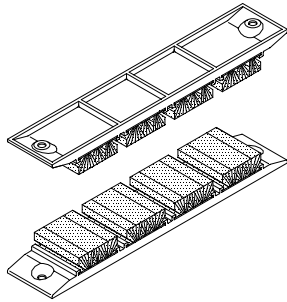

062.8025.04

AFDICHTING MET BORSTEL
FERMETURE AVEC BROSSE
CLOSER WITH BRUSH
ABDICHTUNG MIT BUERSTE

CP 155
006.1301.04

CP 155-LS
006.1301.04

CP 155-AP
006.1301.04

CP 155-LS/AP
006.1301.04



4 st./pc
053.5403.--

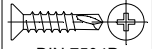

DIN 7504P
4.2 x 13

H=8.1
B=37.4
D=176

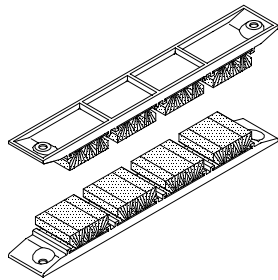

062.8027.04

AFDICHTING MET BORSTEL
FERMETURE AVEC BROSSE
CLOSER WITH BRUSH
ABDICHTUNG MIT BUERSTE

CP 155
006.0320.XX

CP 155-LS
006.0320.XX

CP 155-AP
006.0320.XX

CP 155-LS/AP
006.0320.XX



4 st./pc
053.5403.--

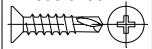

DIN 7504P
4.2 x 13



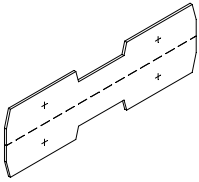
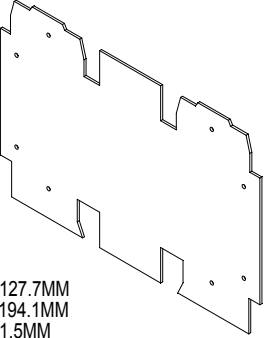
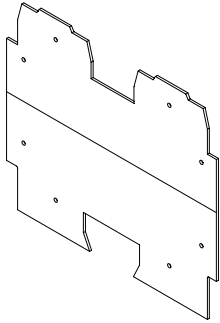
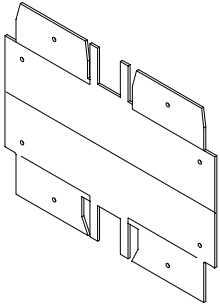
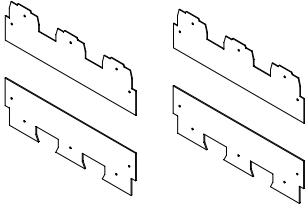

H=8.1
B=30
D=176

 <p>H=44 B=1.5 D=142</p>	<p>062.9392.04 AFDICHTING BUITENKADER FERMETURE DORMANT CLOSER OUTER FRAME ABDICHTUNG BLENDRAHMEN</p>	<p>CP 155-LS 006.0317.XX 006.0318.XX</p>		
 <p>H=127.7MM B=194.1MM D=1.5MM</p>	<p>062.9393.04 AFDICHTING FERMETURE CLOSER ABDICHTUNG</p>	<p>CP 155-LS 006.0321.XX 006.0323.XX</p>		
 <p>H=138 B=157 D=1.5</p>	<p>062.9396.04 AFDICHTING BUITENKADER FERMETURE DORMANT CLOSER OUTER FRAME ABDICHTUNG BLENDRAHMEN</p>	<p>CP 155 006.1300.XX CP 155-LS 006.1300.XX 006.1302.XX</p>		
 <p>H=125 B=157 D=1.5</p>	<p>062.9397.04 AFDICHTING MONORAIL FERMETURE MONORAIL CLOSER MONORAIL ABDICHTUNG MONORAIL</p>	<p>CP 155 006.0320.XX CP 155-LS 006.0320.XX 006.1322.XX</p>		
 <p>H=72.5 B=244 D=1.5</p>	<p>062.9399.04 AFDICHTING BUITENKADER FERMETURE DORMANT CLOSER OUTER FRAME ABDICHTUNG BLENDRAHMEN</p>	<p>CP 155 006.1400.XX CP 155-LS 006.1400.XX 006.1402.XX</p>		

CP 155 CP 155-LS

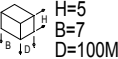
BORSTELDICHTINGEN
JOINTS-BROSSE
BRUSHES
BUERSTENDICHTUNGEN

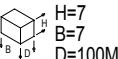

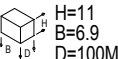

 	<p>081.9091.04 BORSTELDICHTING 5MM JOINT-BROSSE 5MM WOOLPILE 5MM BUERSTENDICHTUNG 5MM</p>	<p>MOSQUITO CS 59Pa CS 59 CS 68 VISION 50 TP 110 TP 138 TLS 110 CP 155 CP 155-LS CS 77 CS 77-BP</p>	<p>CS 77-FP Eco system Eco system-AP</p>
 	<p>081.9092.04 BORSTELDICHTING 7MM JOINT-BROSSE 7MM WOOLPILE 7MM BUERSTENDICHTUNG 7MM</p>	<p>CS 59Pa CS 59 CS 68 VISION 50 TP 110 TP 138 TLS 110 CP 155 CP 155-LS MOSQUITO CS 77 CS 77-BP CS 77-FP</p>	<p>Eco system Eco system-AP</p>
 	<p>081.9241.07 BORSTELDICHTING 11MM JOINT-BROSSE 11MM WOOLPILE 11MM BUERSTENDICHTUNG 11MM</p>	<p>MOSQUITO CP 155</p>	

CP 155-LS/HI MINERGIE LABEL

ISOLEREND VULSTUK
PIECE DE REMPLISSAGE ISOLEE
INSULATING FILLING PIECE
ISOLIERENDES FUELLSTUECK

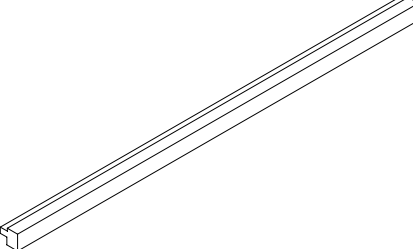
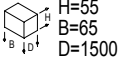
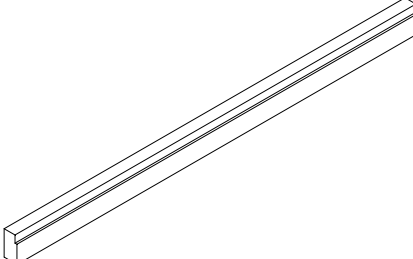
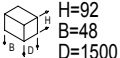

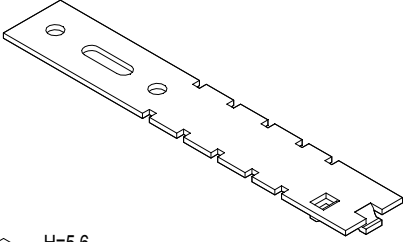
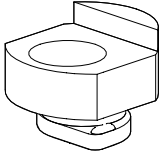
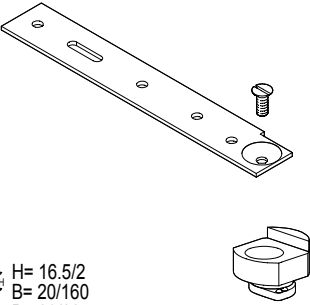
		●	●	≡
 	<p>084.9410.01</p> <p>ISOLEREND VULSTUK 55MMx65MMx1500MM PIECE DE REMPLISSAGE ISOLEE 55MMx65MMx1500MM INSULATING FILLING PIECE 55MMx65MMx1500MM ISOLIERENDES FUELLSTUECK 55MMx65MMx1500MM</p>	<p>CP 155-LS 006.2340.XX</p>		
 	<p>084.9411.01</p> <p>ISOLEREND VULSTUK 92MMx48MMx1500MM PIECE DE REMPLISSAGE ISOLEE 92MMx48MMx1500MM INSULATING FILLING PIECE 92MMx48MMx1500MM ISOLIERENDES FUELLSTUECK 92MMx48MMx1500MM</p>	<p>CP 155-LS 006.0350.XX</p>		

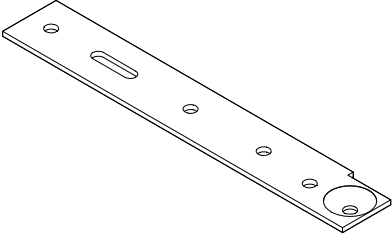
 <p>H=5.6 B=160 D=25</p>	<p>056.6297.00 INDRAAI-ANKER ANCRAGE A CLIPPER SCREW FIXING LUG MAUERANKER ZUM EINKLEMMEN</p>	<p>CS 59Pa CS 59 CS 59-HV CS 59-Re CS 59-So CS 68 CS 68-HV CS 68-Re CS 68-So TP 110 TLS 110 CP 130 CP 155</p>	<p>CS 77 CS 77-HV CS 77-BP TP 110-Re Eco system Eco system-AP</p>	
 <p>H=16.5 B=20 D=23</p>	<p>056.6298.01 ANKERSTUK KUNSTSTOF PIECE D'ANCRAGE MATIERE SYNTHETIQUE ANCHOR PIECE SYNTHETIC ANKERSTUECK KUNSTSTOFF</p>	<p>CS 59Pa CS 59 CS 59-HV CS 59-Re CS 59-So CS 68 CS 68-HV CS 68-Re CS 68-So TP 110 TLS 110 CP 130 CP 155</p>	<p>CS 77 CS 77-HV CS 77-BP TP 110-Re Eco system Eco system-AP</p>	
 <p>H= 16.5/2 B= 20/160 D= 23/22.5</p>	<p>056.6299.-- ANKERBEVESTIGING GEISOLEERD ANCRAGE ISOLE INSULATED ANCHORING ISOLIERTE VERANKERUNG</p>	<p>CS 59Pa CS 59 CS 59-HV CS 59-Re CS 59-So CS 68 CS 68-HV CS 68-Re CS 68-So TP 110 TLS 110 CP 130 CP 155</p>	<p>CS 77 CS 77-HV CS 77-BP TP 110-Re Eco system Eco system-AP</p>	<p>1 st./pc 050.5130.--  DIN 965 M5 x 10</p>
 <p>H=2 B=160 D=22.5</p>	<p>056.6301.-- ANKERSTUK BASE D'ANCRAGE PART ANCHOR EINDREHANKER</p>	<p>CS 59 CS 68 TP 110 TLS 110 CP 130 CP 155 CS 77 TP 110-Re</p>		

CP 155 CP 155-LS

VERANKERINGEN
ANCRAGES
ANCHORINGS
VERANKERUNGEN

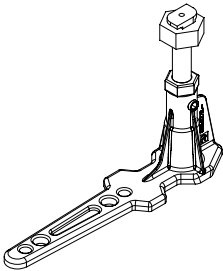
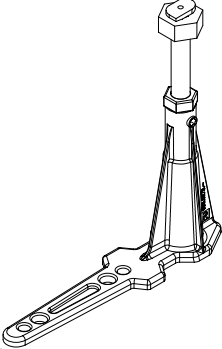

 <p>H=70-110MM B=35MM D=155MM</p>	<p>056.6270.--</p> <p>ANKER ANCRAGE ANCHOR ANKER</p>	<p>CP 130 CP 130-LS CP 155 CP 155-LS CP 155-AP CP 155-LS/AP CP 50 CP 96 CP 45Pa CP 96-LS CP 96-AP CP 96-LS/AP CP 50-HI</p>		
 <p>H=110-180MM B=35MM D=155MM</p>	<p>056.6273.--</p> <p>ANKER ANCRAGE ANCHOR ANKER</p>	<p>CP 130 CP 130-LS CP 155 CP 155-LS CP 155-AP CP 155-LS/AP CP 50 CP 96 CP 45Pa CP 96-LS CP 96-AP CP 96-LS/AP CP 50-HI</p>		
Empty section				

CP 155
CP 155-LS

DIVERSEN
DIVERS
MISCELLANEOUS
DIVERSE



084.9080.--

REYNASEAL DUO
REYNASEAL DUO
REYNASEAL DUO
REYNASEAL DUO



550GR

084.9103.04

VULKANISEERLIJM DICHTINGEN 310ML
COLLE VULCANISANTE JOINTS 310ML
VULCANISING GLUE GASKETS 310ML
VULKANISIERKLEBER DICHTUNGEN 310ML



310ML

084.9106.--

SEKONDENLIJM 20G
COLLE RAPIDE 20G
CONTACT GLUE 20G
SEKUNDENKLEBER 20G







20G

CP 155
CP 155-LS

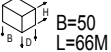
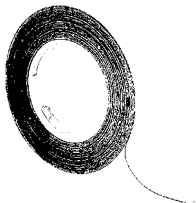
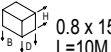
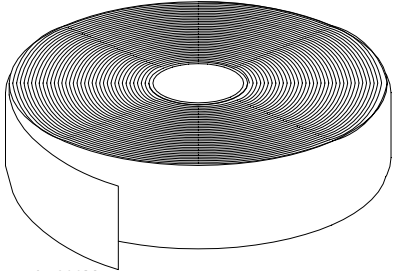
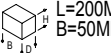
DIVERSEN
DIVERS
MISCELLANEOUS
DIVERSE



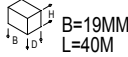
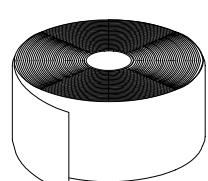
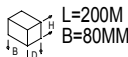
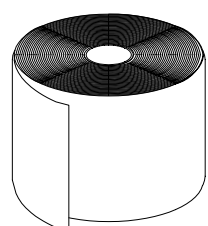
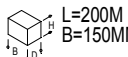

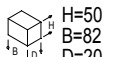
 	<p>084.9111.--</p> <p>KLEEFBAND POLYPROPYLEEN BANDE AUTOCOLLANTE POLYPROPYLENE TAPE SELF-ADHESIVE POLYPROPYLENE KLEBENDES BAND POLYPROPYLEN</p>			
 	<p>084.9113.--</p> <p>KLEEFBAND 2-ZIJDEN KLEVEND BANDE 2 FACES AUTOCOLLANTES TAPE DOUBLE SIDES SELF-ADHESIVE KLEBENDES BAND BEIDSEITIG</p>			
 	<p>084.9550.01</p> <p>REYNATAPE 50MM L=200M REYNATAPE 50MM L=200M REYNATAPE 50MM L=200M REYNATAPE 50MM L=200M</p>			

 	<p>084.9480.-- KLEEFBAND 2-ZIJDEN KLEVEND BANDE 2 FACES AUTOCOLLANTES TAPE DOUBLE SIDES SELF-ADHESIVE BEIDSEITIG KLEBENDES BAND</p>			
 	<p>084.9580.01 REYNATAPE 80MM L=200M REYNATAPE 80MM L=200M REYNATAPE 80MM L=200M REYNATAPE 80MM L=200M</p>			
 	<p>084.9750.01 REYNATAPE 150MM L=200M REYNATAPE 150MM L=200M REYNATAPE 150MM L=200M REYNATAPE 150MM L=200M</p>			
 	<p>086.9150.-- ALU GOM VOOR VLEKKEN GOMME POUR GRIFFES ET TACHES RUBBING BLOCK REINIGUNGSPAD FÜR ELOXAL-FLACHEN</p>			

CP 155
CP 155-LS

DIVERSEN
DIVERS
MISCELLANEOUS
DIVERSE



  B=100MM L=50M	<p>086.9160.-- INPAKPAPIER PAPIER CREPONE PACKAGING PAPER VERPACKUNGSPAPIER</p>			
  500ML	<p>086.9175.-- SNIJMIDDEL-SPRAY 500ML AEROSOL D'HUILE DE COUPE 500ML CUTTING SPRAY 500ML SCHNEIDMITTEL-SPRAY 500ML</p>	<p>CS 77 CW 86</p>		
  1L	<p>086.9210.-- REYNAFINISH 60 REYNAFINISH 60 REYNAFINISH 60 REYNAFINISH 60</p>			
  500ML	<p>086.9213.-- REYNAWASH ANO REYNAWASH ANO REYNAWASH ANO REYNAWASH ANO</p>			

 <p>REYNAPROTECTOR 086.9208.01</p> <p>REYNAPROTECTOR 086.9208.04</p> <p>REYNAPROTECTOR 086.9208.07</p> <p>310ML</p>	<p>086.9208.SY</p> <p>REYNAPROTECTOR SILICONE REYNAPROTECTOR SILICONE REYNAPROTECTOR SILICONE REYNAPROTECTOR SILICONEN</p>			
 <p>500ML</p>	<p>086.9211.--</p> <p>REYNOVATOR 718 REYNOVATOR 718 REYNOVATOR 718 REYNOVATOR 718</p>			
	<p>086.9225.--</p> <p>SCHUIMROL ROULEAU EN MOUSSE SCHAUMROLLE FOAM ROLL</p>			
 <p>400ML</p>	<p>086.9551.--</p> <p>SILICONE-SPRAY 400ML AEROSOL-SILICONE 400ML SILICONE SPRAY 400ML SILICONENSpray 400ML</p>			
Empty row				



086.9600.XX

REYNASTICK
REYNASTICK
REYNASTICK
REYNASTICK



--	--	--	--	--	--	--	--



084.9080.--

REYNASEAL DUO
REYNASEAL DUO
REYNASEAL DUO
REYNASEAL DUO



 550GR

084.9085.--

MENGTUIT REYNASEAL DUO
PIECE DE MELANGE REYNASEAL DUO
MIXING NOZZLE REYNASEAL DUO
MISCHSTUECK REYNASEAL DUO





084.9041.04

ILLMOD 600 15/3-7MM
ILLMOD 600 15/3-7MM
ILLMOD 600 15/3-7MM
ILLMOD 600 15/3-7MM

CS 59Pa	CP 155-LS	CS 59-PDCS	CS 38-SL Optima
CS 59Pa-AD	CS 68-FP	CS 68-PD	CS 77-SP
CS 59Pa-CD	CS 77	CS 68-FP/PDCS	CS 77 Optima
CS 59Pa-SD	CS 77-HV	CS 77-PD	CF 77-AP
CS 59	CS 59Pa-AP	Eco system	
CS 59-HV	CS 59-AP	CS 38-SL	
CS 59-Re	CS 68-AP	CS 86-HI	
CS 59-So	CS 77-AP	Eco system-AP	
CS 59-AD	CS 77-BP	CS 38-SL/AP	
CS 59-CD	CS 77-FP	CS 24-SL	
CS 59-SD	TP 110-AP	CS 24-SL/AP	
CS 68	CP 155-AP	CS 38-SL/FP	
CS 68-HV	CP 155-LS/AP	CS 77-Re	
CS 68-Re	CP 96	Eco system Optima	
CS 68-So	CP 45Pa	Eco system 75	
TP 110	CP 96-LS	CS 86-HI/AP	
TLS 110	CP 96-APCS	CS 68 Optima-AP	
CP 130	CP 96-LS/AP	Eco system Optima-AP	
CP 130-LS	TP 110-Re	CF 77	
CP 155	CS 68 Optima	CS 104	



084.9051.04

ILLMOD 600 15/7-12MM
ILLMOD 600 15/7-12MM
ILLMOD 600 15/7-12MM
ILLMOD 600 15/7-12MM

CS 59Pa	CP 155-LS	CS 59-PDCS	CS 38-SL Optima
CS 59Pa-AD	CS 68-FP	CS 68-PD	CS 77-SP
CS 59Pa-CD	CS 77	CS 68-FP/PDCS	CS 77 Optima
CS 59Pa-SD	CS 77-HV	CS 77-PD	CF 77-AP
CS 59	CS 59Pa-AP	Eco system	
CS 59-HV	CS 59-AP	CS 38-SL	
CS 59-Re	CS 68-AP	CS 86-HI	
CS 59-So	CS 77-AP	Eco system-AP	
CS 59-AD	CS 77-BP	CS 38-SL/AP	
CS 59-CD	CS 77-FP	CS 24-SL	
CS 59-SD	TP 110-AP	CS 24-SL/AP	
CS 68	CP 155-AP	CS 38-SL/FP	
CS 68-HV	CP 155-LS/AP	CS 77-Re	
CS 68-Re	CP 96	Eco system Optima	
CS 68-So	CP 45Pa	Eco system 75	
TP 110	CP 96-LS	CS 86-HI/AP	
TLS 110	CP 96-APCS	CS 68 Optima-AP	
CP 130	CP 96-LS/AP	Eco system Optima-AP	
CP 130-LS	TP 110-Re	CF 77	
CP 155	CS 68 Optima	CS 104	



084.9414.07

DUOFOLIE E 140MM + 15MM BUTYL
DUOFOLIE E 140MM + 15MM BUTYL
DUOFOLIE E 140MM + 15MM BUTYL
DUOFOLIE E 140MM + 15MM BUTYL

CS 59Pa	CP 155-LS	CS 59-PDCS	38-SL Optima
CS 59Pa-AD	CS 68-FP	CS 68-PD	CS 77-SP
CS 59Pa-CD	CS 77	CS 68-FP/PDCS	CS 77 Optima
CS 59Pa-SD	CS 77-HV	CS 77-PD	CF 77-AP
CS 59	CS 59Pa-AP	Eco system	
CS 59-HV	CS 59-AP	CS 38-SL	
CS 59-Re	CS 68-AP	CS 86-HI	
CS 59-So	CS 77-AP	Eco system-AP	
CS 59-AD	CS 77-BP	CS 38-SL/AP	
CS 59-CD	CS 77-FP	CS 24-SL	
CS 59-SD	TP 110-AP	CS 24-SL/AP	
CS 68	CP 155-AP	CS 38-SL/FP	
CS 68-HV	CP 155-LS/AP	CS 77-Re	
CS 68-Re	CP 96	Eco system Optima	
CS 68-So	CP 45Pa	Eco system 75	
TP 110	CP 96-LS	CS 86-HI/AP	
TLS 110	CP 96-APCS	68 Optima-AP	
CP 130	CP 96-LS/AP	Eco system Optima-AP	
CP 130-LS	TP 110-Re	CF 77	
CP 155	CS 68 Optima	CS 104	

B=140MM
L=50M



084.9420.07

DUOFOLIE E 200MM + 15MM BUTYL
DUOFOLIE E 200MM + 15MM BUTYL
DUOFOLIE E 200MM + 15MM BUTYL
DUOFOLIE E 200MM + 15MM BUTYL

CS 59Pa	CP 155-LS	CS 59-PDCS	38-SL Optima
CS 59Pa-AD	CS 68-FP	CS 68-PD	CS 77-SP
CS 59Pa-CD	CS 77	CS 68-FP/PDCS	CS 77 Optima
CS 59Pa-SD	CS 77-HV	CS 77-PD	CF 77-AP
CS 59	CS 59Pa-AP	Eco system	
CS 59-HV	CS 59-AP	CS 38-SL	
CS 59-Re	CS 68-AP	CS 86-HI	
CS 59-So	CS 77-AP	Eco system-AP	
CS 59-AD	CS 77-BP	CS 38-SL/AP	
CS 59-CD	CS 77-FP	CS 24-SL	
CS 59-SD	TP 110-AP	CS 24-SL/AP	
CS 68	CP 155-AP	CS 38-SL/FP	
CS 68-HV	CP 155-LS/AP	CS 77-Re	
CS 68-Re	CP 96	Eco system Optima	
CS 68-So	CP 45Pa	Eco system 75	
TP 110	CP 96-LS	CS 86-HI/AP	
TLS 110	CP 96-APCS	68 Optima-AP	
CP 130	CP 96-LS/AP	Eco system Optima-AP	
CP 130-LS	TP 110-Re	CF 77	
CP 155	CS 68 Optima	CS 104	

B=200MM
L=50M



084.9090.--

ELASTISCH PU SCHUIM
MOUSSE PISTONABLE ELASTIQUE
GUN FOAM ELASTIC
PISTOLENSCHAUM ELASTISCH

CS 59Pa	CP 155-LS	CS 59-PDCS	CS 38-SL Optima
CS 59Pa-AD	CS 68-FP	CS 68-PD	CS 77-SP
CS 59Pa-CD	CS 77	CS 68-FP/PDCS	CS 77 Optima
CS 59Pa-SD	CS 77-HV	CS 77-PD	CF 77-AP
CS 59	CS 59Pa-AP	Eco system	
CS 59-HV	CS 59-AP	CS 38-SL	
CS 59-Re	CS 68-AP	CS 86-HI	
CS 59-So	CS 77-AP	Eco system-AP	
CS 59-AD	CS 77-BP	CS 38-SL/AP	
CS 59-CD	CS 77-FP	CS 24-SL	
CS 59-SD	TP 110-AP	CS 24-SL/AP	
CS 68	CP 155-AP	CS 38-SL/FP	
CS 68-HV	CP 155-LS/AP	CS 77-Re	
CS 68-Re	CP 96	Eco system Optima	
CS 68-So	CP 45Pa	Eco system 75	
TP 110	CP 96-LS	CS 86-HI/AP	
TLS 110	CP 96-APCS	CS 68 Optima-AP	
CP 130	CP 96-LS/AP	Eco system Optima-AP	
CP 130-LS	TP 110-Re	CF 77	
CP 155	CS 68 Optima	CS 104	



084.9140.--

HECHTPASTA OT300
PATE ADHESIVE OT300
ADHESIVE PASTE OT 300
NAHTPASTE OT300

CS 59Pa	CP 155-LS	CS 59-PDCS	CS 38-SL Optima
CS 59Pa-AD	CS 68-FP	CS 68-PD	CS 77-SP
CS 59Pa-CD	CS 77	CS 68-FP/PDCS	CS 77 Optima
CS 59Pa-SD	CS 77-HV	CS 77-PD	CF 77-AP
CS 59	CS 59Pa-AP	Eco system	
CS 59-HV	CS 59-AP	CS 38-SL	
CS 59-Re	CS 68-AP	CS 86-HI	
CS 59-So	CS 77-AP	Eco system-AP	
CS 59-AD	CS 77-BP	CS 38-SL/AP	
CS 59-CD	CS 77-FP	CS 24-SL	
CS 59-SD	TP 110-AP	CS 24-SL/AP	
CS 68	CP 155-AP	CS 38-SL/FP	
CS 68-HV	CP 155-LS/AP	CS 77-Re	
CS 68-Re	CP 96	Eco system Optima	
CS 68-So	CP 45Pa	Eco system 75	
TP 110	CP 96-LS	CS 86-HI/AP	
TLS 110	CP 96-APCS	CS 68 Optima-AP	
CP 130	CP 96-LS/AP	Eco system Optima-AP	
CP 130-LS	TP 110-Re	CF 77	
CP 155	CS 68 Optima	CS 104	

300ML



084.9426.04

DUOFOLIE E PREFAB 200MM
DUOFOLIE E PREFAB 200MM
DUOFOLIE E PREFAB 200MM
DUOFOLIE E PREFAB 200MM

CS 59Pa	CP 155-LS	CS 59-PDCS	38-SL Optima
CS 59Pa-AD	CS 68-FP	CS 68-PD	CS 77-SP
CS 59Pa-CD	CS 77	CS 68-FP/PDCS	CS 77 Optima
CS 59Pa-SD	CS 77-HV	CS 77-PD	CF 77-AP
CS 59	CS 59Pa-AP	Eco system	
CS 59-HV	CS 59-AP	CS 38-SL	
CS 59-Re	CS 68-AP	CS 86-HI	
CS 59-So	CS 77-AP	Eco system-AP	
CS 59-AD	CS 77-BP	CS 38-SL/AP	
CS 59-CD	CS 77-FP	CS 24-SL	
CS 59-SD	TP 110-AP	CS 24-SL/AP	
CS 68	CP 155-AP	CS 38-SL/FP	
CS 68-HV	CP 155-LS/AP	CS 77-Re	
CS 68-Re	CP 96	Eco system Optima	
CS 68-So	CP 45Pa	Eco system 75	
TP 110	CP 96-LS	CS 86-HI/AP	
TLS 110	CP 96-APCS	68 Optima-AP	
CP 130	CP 96-LS/AP	Eco system Optima-AP	
CP 130-LS	TP 110-Re	CF 77	
CP 155	CS 68 Optima	CS 104	

 B=220MM
L=25M

CP 155 CP 155-LS

BEVESTIGINGSMIDDELEN
MOYENS DE FIXATION
FIXINGS
BEFESTIGUNGSMITTEL



		d	afm. dimen. L	dimen. Masse k	D
	050.5010.--	M5	6	3.8	10
	050.5013.--	M5	16	3.8	10
	050.5014.--	M5	20	3.8	10
	050.5016.--	M5	12	3.8	10
	050.5019.--	M4	18	3.1	8
	050.5035.--	M4	60	3.1	8
	050.5065.--	M4	5	3.1	8
	050.5066.--	M4	14	2.5	6.5
	050.5092.--	M4	8	3.1	8
	050.5109.--	M4	12	3.1	8
	050.5110.--	M5	8	3.8	10
	050.5111.--	M6	8	4.6	12
	050.5112.--	M6	25	4.6	12
	050.5113.--	M6	115	4.6	10
ISO 7045					
	050.5020.--	M5	16	3.8	9.5
	050.5026.--	M5	17.8	3.8	10
	050.5117.--	M5	8	3.8	10
	050.5118.--	M5	6	3.8	10
	050.5119.--	M5	12	3.8	10
	SCHROEF MET BORGINGSVERF VIS AVEC COLLE DE BLOCAGE SCREW WITH LOCK PAINT SCHRAUBE MIT SICHERUNGSFARBE				
ISO 7045					
	050.5021.--	M6	45	6	10
	050.5022.--	M6	60	6	10
	050.5023.--	M6	65	6	10
	050.5024.--	M6	70	6	10
	050.5029.--	M6	16	6	10
	050.5030.--	M6	50	6	10
	050.5031.--	M6	20	6	10
	050.5032.--	M6	30	6	10
	050.5033.--	M6	35	6	10
	050.5034.--	M6	40	6	10
	050.5071.--*	M5	12	5	8.5
	050.5180.--	M6	25	6	10
	050.5260.--	M8	20	8	13
	ISO 4762				
	* used in assembly, sales = no				

CP 155 CP 155-LS

BEVESTIGINGSMIDDELEN
MOYENS DE FIXATION
FIXINGS
BEFESTIGUNGSMITTEL

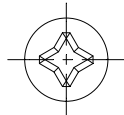
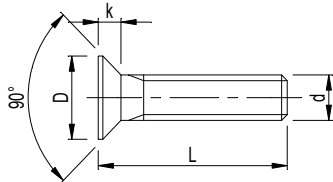

ISO 7046

* used in assembly, sales = no

d	afm. dimen. L	dimen. Masse k	D
---	---------------	----------------	---

050.5001.--	M5	25	2.5	9.2
050.5002.--	M4	8	2.2	7.5
050.5003.--	M4	12	2.2	7.5
050.5004.--*	M5	60	2.5	9.2
050.5005.--	M5	55	2.5	9.2
050.5008.--*	M5	95	2.5	9.2
050.5011.--	M5	20	2.5	9.2
050.5015.--	M5	8	2.5	9.2
050.5017.--	M5	30	2.5	9.2
050.5018.--	M4	16	2.2	7.5
050.5036.--	M5	100	2.5	9.2
050.5050.--	M6	25	3	11
050.5051.--	M6	30	3	11
050.5052.--	M6	35	3	11
050.5053.--	M6	12	3	11
050.5055.--	M6	45	3	11
050.5060.--	M6	16	4	11
050.5075.--	M8	20	3	14.5
050.5077.--	M4	25	2.2	7.3
050.5078.--	M4	30	2.2	7.3
050.5081.--	M5	45	2.5	9.2
050.5082.--	M5	70	2.5	9.2
050.5083.--	M5	80	2.5	9.2
050.5084.--	M5	90	2.5	9.2
050.5130.--	M5	10	2.5	9.2
050.5131.--	M5	12	2.5	9.2
050.5132.--	M5	6	2.5	11
050.5139.--	M6	8	3	11
050.5140.--	M6	10	3	11
050.5141.--	M6	70	3	11
050.5142.--	M6	80	3	9.2
050.5161.--	M5	16	2.5	9.2
050.5170.--	M4	10	2.2	7.5

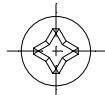
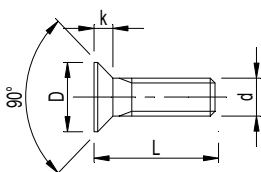

ISO 7046

050.5000.--	M5	10	2.5	9.2
050.5009.--	M5	16	2.5	9.2
050.5012.--	M5	12	2.5	9.2
050.5080.--	M5	40	2.5	9.2
SCHROEF MET BORGINGSVERF VIS AVEC COLLE DE BLOCAGE SCREW WITH LOCK PAINT SCHRAUBE MIT SICHERUNGSFARBE				

D0066364

CP 155 CP 155-LS

BEVESTIGINGSMIDDELEN
MOYENS DE FIXATION
FIXINGS
BEFESTIGUNGSMITTEL

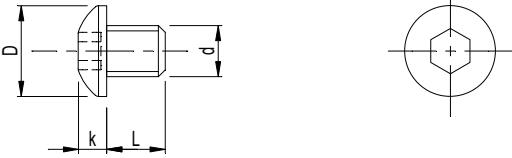
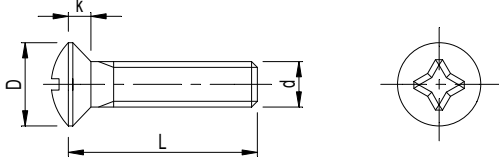
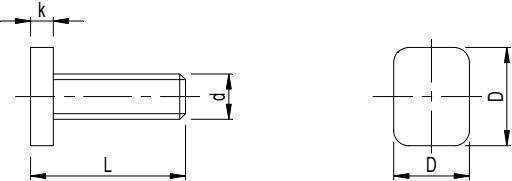
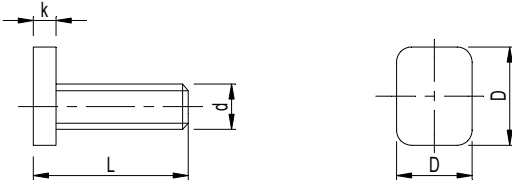
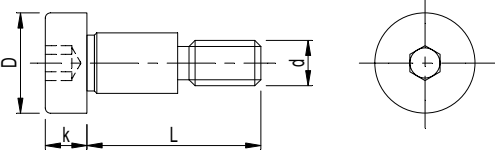
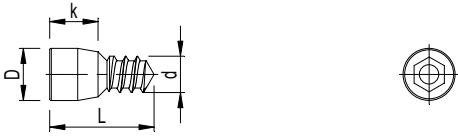

			d	afm. dimen. L	dimen. Masse k	D
 <p>ISO 7380</p>	050.5230.--	M8	10	4.4	14	
 <p>ISO 7047</p>	050.5191.--	M6	45	3	11	
	050.5381.--	M6	16	3	10x14	
 <p>EN ISO 3506</p>	050.5398.--	7.2	10	3	15x20	
 <p>ISO 7379</p>	050.5196.--	13.3	23	5.5	M6	
	050.5153.--	4.8	13.8	6.4	6.9	

CP 155 CP 155-LS

BEVESTIGINGSMIDDELEN
MOYENS DE FIXATION
FIXINGS
BEFESTIGUNGSMITTEL

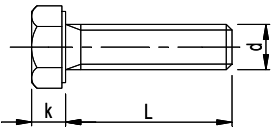
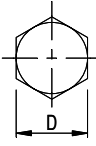
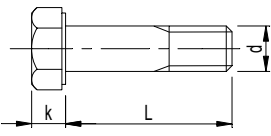
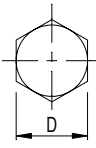
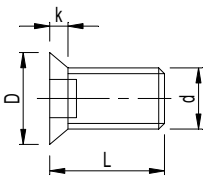
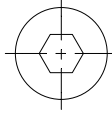
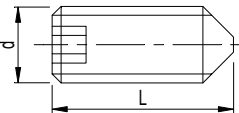
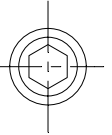
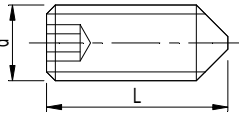
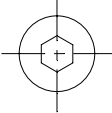

		d	afm. dimen. L	dimen. Masse k	D
  <p>ISO 4017</p>	050.5200.--	M10	40	6.4	17
	050.5201.--	M10	80	6.4	17
	050.5203.--	M10	60	6.4	17
	050.5204.--	M10	22	6.4	17
	050.5205.--	M10	70	6.4	17
	050.5270.--	M4	6	2.8	7
	050.5271.--	M4	10	2.8	7
	050.5388.--	M10	100	6.4	17
	050.5391.--	M6	20	4	10
  <p>ISO 4014</p>	050.5389.--	M10	130	6.4	17
  <p>DIN 7991</p>	050.5040.--	M6	10	4	12
	050.5091.--	M8	10	2.4	12
	050.5093.--	M8	8	2.4	12
	050.5094.--	M8	15	2.4	12
  <p>ISO 4026</p>	051.5262.--	M6	8		
	051.5263.--*	M6	12		
	051.5264.--*	M6	20		
	051.5291.--	M8	8		
	051.5292.--	M8	12		
	051.5299.--*	M12	12		
	* used in assembly, sales = no				
  <p>ISO 4027</p>	051.5252.--	M5	12		
	051.5269.--	M8	12		
	051.5270.--	M8	8		
	051.5271.--	M6	10		
	051.5272.--	M5	6		
	051.5273.--	M4	5		
	051.5274.--	M6	6		
	051.5278.--	M6	16		
	051.5279.--	M4	10		

CP 155 CP 155-LS

BEVESTIGINGSMIDDELEN
MOYENS DE FIXATION
FIXINGS
BEFESTIGUNGSMITTEL

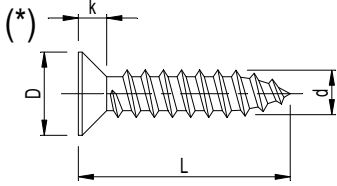
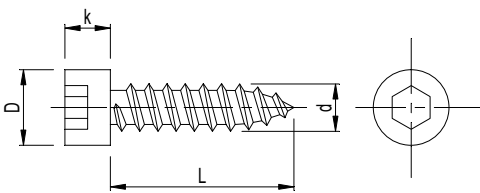

		d	afm. dimen. L	dimen. Masse k	D
	050.5108.--(*)	3	6	2.3	5
	052.5308.--(*)	3.5	13	2.1	6.8
	052.5309.--	3.9	19	2.3	7.5
	052.5311.--	4.2	16	2.5	8.1
	052.5312.--	4.2	13	2.5	8.1
	052.5313.--	4.2	32	2.5	8.1
	052.5316.--	4.2	19	2.5	8.1
	052.5318.--	4.2	38	2.5	8.1
	052.5322.--	4.2	70	2.5	8.1
	052.5327.--	4.2	25	2.5	8.1
	052.5328.--	4.2	60	2.5	8.1
	052.5329.--	4.2	50	2.5	8.1
	052.5331.--	4.8	19	3	9.5
	052.5332.--	4.8	13	3	9.5
	052.5333.--	4.8	25	3	9.5
	052.5334.--	4.8	70	3	9.5
	052.5335.--	4.8	45	3	9.5
	052.5336.--	4.8	32	3	9.5
	052.5337.--	4.8	38	3	9.5
	052.5338.--	4.8	50	3	9.5
052.5339.--	5.5	13	3	9.5	
052.5380.--	6.3	13	3.8	12.4	
052.5381.--	6.3	38	3.8	12.4	
ISO 7050					
	052.5371.--	6.3	38	6	10
	052.5372.--	6.3	13	6	10
	052.5373.--	6.3	70	6	10

CP 155 CP 155-LS

BEVESTIGINGSMIDDELEN
MOYENS DE FIXATION
FIXINGS
BEFESTIGUNGSMITTEL

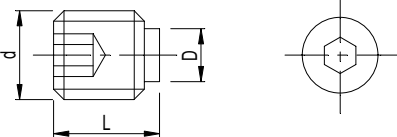
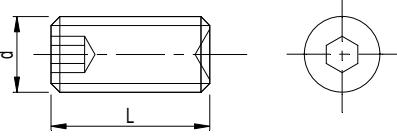
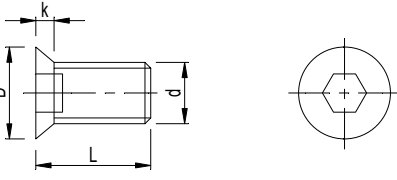
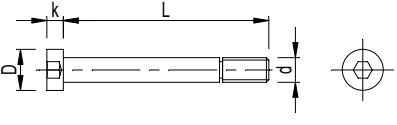
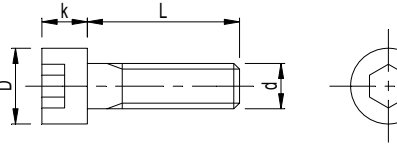

		d	afm. dimen. L	dimen. Masse k	D
 <p>ISO 4028</p>	051.5254.--	M5	6		3.5
	051.5255.--	M5	12		3.5
	051.5253.--	M5	35		3.8
 <p>ISO 4029</p>	051.5240.--	M5	6		
	051.5250.--	M5	10		
	051.5280.--	M5	12		
	051.5281.--	M4	10		
	051.5282.--	M4	8		
	051.5284.--	M4	5		
	051.5290.--	M8	10		
051.5291.--	M8	8			
 <p>ISO 10642</p>	050.5076.--	M4	6	2.2	7.5
<p>SCHROEF MET BORGINGSVERF VIS AVEC COLLE DE BLOCAGE SCREW WITH LOCK PAINT SCHRAUBE MIT SICHERUNGSFARBE</p>					
 <p>DIN 7984</p>	050.5045.--	M6	50	4	10
<p>SCHROEF MET BORGINGSVERF VIS AVEC COLLE DE BLOCAGE SCREW WITH LOCK PAINT SCHRAUBE MIT SICHERUNGSFARBE</p>					
 <p>ISO 4762</p>	050.5028.--	M6	16	6	10
	050.5039.--	M6	18	6	10
<p>SCHROEF MET BORGINGSVERF VIS AVEC COLLE DE BLOCAGE SCREW WITH LOCK PAINT SCHRAUBE MIT SICHERUNGSFARBE</p>					

D0066367

CP 155 CP 155-LS

BEVESTIGINGSMIDDELEN
MOYENS DE FIXATION
FIXINGS
BEFESTIGUNGSMITTEL



		d	afm. dimen. L	dimen. Masse k	D
	052.5200.--	3.9	19	2.8	7.5
	052.5300.--	4.8	19	3.55	9.5
	052.5301.--	4.8	38	3.55	9.5
	052.5302.--	4.8	50	3.55	9.5
	052.5304.--	4.8	90	3.55	9.5
	052.5305.--	4.8	80	3.55	9.5
	052.5310.--	4.2	16	3.05	8.2
	052.5314.--	4.2	50	3.05	8.2
	052.5315.--	4.2	25	3.05	8.2
	052.5317.--	4.2	13	3.05	8.2
	052.5320.--	3.5	9.5	2.6	6.9
	052.5321.--	4.2	32	3.05	8.2
	052.5330.--	4.8	13	3.55	9.5
	052.5340.--	5.5	45	3.95	10.8
	052.5341.--	5.5	38	3.95	10.8
	052.5342.--	5.5	32	3.95	10.8
	052.5343.--	5.5	25	3.95	10.8
	052.5344.--	5.5	13	3.95	10.8
	052.5350.--	6.3	25	4.55	12.5
	052.5351.--	6.3	38	4.55	12.5
052.5360.--	4.2	9.5	3.05	8.2	
ISO 7049					
<p>TORX EN ISO 3506-1</p>	052.5400.--	4.8	38	2.5	8.9
<p>BIMETAL DRILL IN STEEL ISO 3506</p>	053.5200.--	5.5	90	5	8
	053.5201.--	5.5	110	5	8

CP 155 CP 155-LS

BEVESTIGINGSMIDDELEN
MOYENS DE FIXATION
FIXINGS
BEFESTIGUNGSMITTEL



		d	afm. dimen. L	dimen. Masse k	D
<p>DIN 7504P</p>	053.5401.--	4.2	25	2.5	8.1
	053.5403.--	4.2	13	2.5	8.1
	053.5409.--	3.9	16	2.1	7.5
<p>DIN 7504N</p>	053.5402.--	4.2	38	2.5	8.1
	053.5411.--	4.8	32	3.55	9.5
	053.5412.--	4.2	19	2.5	8.1
	053.5413.--	4.8	50	3.55	9.5
	053.5414.--	4.8	60	3.7	9.5
	053.5415.--	4.8	70	3.7	9.5
	0FR.9881.--	4.8	25	3.55	9.5
<p>TORX</p>	021.5169.--	M5	11	4.8	9.7
	024.5521.--	M5	14	4.8	9.7
<p>ISO 2768-F</p>	053.5460.--	6.3	19	3.95	10
	053.5461.--	6.3	22	3.95	10
	053.5462.--	6.3	25	3.95	10
	053.5463.--	6.3	28	3.95	10
	053.5464.--	6.3	31	3.95	10
	053.5465.--	6.3	34	3.95	10
	053.5466.--	6.3	37	3.95	10
	053.5467.--	6.3	40	3.95	10
	053.5468.--	6.3	43	3.95	10
	053.5469.--	6.3	46	3.95	10
	053.5470.--	6.3	49	3.95	10
	053.5471.--	6.3	52	3.95	10
	053.5472.--	6.3	55	3.95	10
	053.5473.--	6.3	58	3.95	10
	053.5474.--	6.3	61	3.95	10
	053.5475.--	6.3	64	3.95	10
	053.5476.--	6.3	67	3.95	10
053.5479.--	6.3	76	3.95	10	
053.5480.--	6.3	109	3.95	10	

CP 155 CP 155-LS

BEVESTIGINGSMIDDELEN
MOYENS DE FIXATION
FIXINGS
BEFESTIGUNGSMITTEL

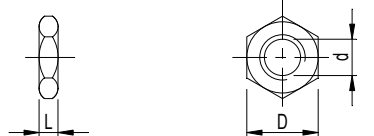
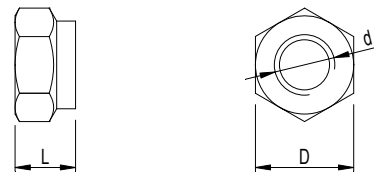
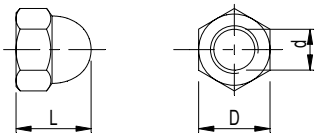
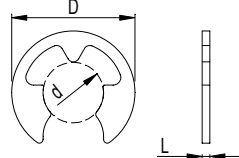

		d	afm. dimen. L	dimen. Masse k	D
 <p>ISO 4032</p>	050.5392.--	M8	5.5		13
	050.5395.--	M6	5		10
	050.5396.--	M5	4		8
	050.5400.--	M4	3.2		7
	079.5398.--	M10	8		17
 <p>DIN 439</p>	050.5401.--	M10	5		17
 <p>DIN 985</p>	050.5393.--	M12	12		19
	050.5394.--	M8	8		13
	050.5403.--	M10	10		17
	050.5407.-- ZESKANTMOER ZELFBORGEND ECROU HEXAGONALE AUTOBLOQUANTE HEXAGON NUT SELF-LOCKING SECHSKANTMUTTER SELBSTSICHEREND	M6	6		10
 <p>DIN 1587</p>	067.5200.--	M6	12		10
	067.5201.--	M10	18		17
	067.5202.--	M12	22		19
 <p>DIN 6799</p>	054.5451.--*	8	1		16.3
	* used in assembly, sales = no				

CP 155 CP 155-LS

BEVESTIGINGSMIDDELEN
MOYENS DE FIXATION
FIXINGS
BEFESTIGUNGSMITTEL

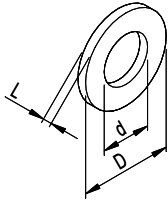
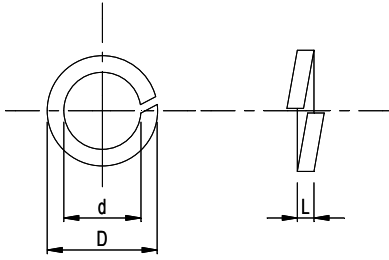
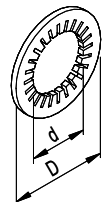
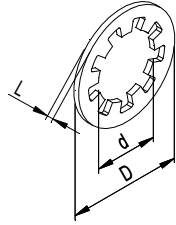
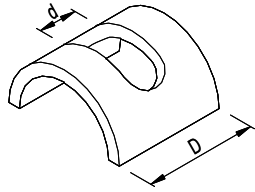
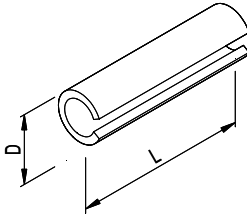

		d	afm. dimen. L	dimen. Masse k	D
 <p>ISO 7089</p>	054.5455.--	4.3	0.8		9
	054.5458.--	8.4	1.6		16
	067.5205.--	10.5	2		20
	067.5206.--	13	2.5		24
 <p>DIN 127B</p>	054.5450.--	10.2	2.2		18.1
 <p>DIN 6797 J</p>	072.5208.--	6.4			11
 <p>DIN 6797 J</p>	079.5206.--	10.5	0.9		18
	072.5209.--	5			14
 <p>ISO 8752</p>	058.5941.--	5	20		
	058.5944.--	4.4	26		
	058.5945.--	4.3	50		
	058.5950.--*	3	24		
	065.6507.--	3.5	6		
	073.6517.--	3.5	12		
	058.5945.--	4.3	50		

* used in assembly, sales = no

CP 155 CP 155-LS

BEVESTIGINGSMIDDELEN
MOYENS DE FIXATION
FIXINGS
BEFESTIGUNGSMITTEL

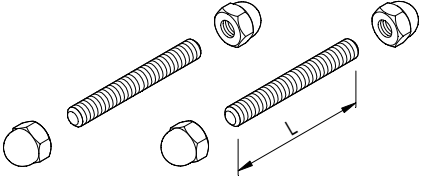
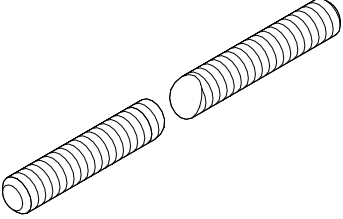

		d	afm. dimen. L	dimen. Masse k	D
	079.5212.--	M6	75		
 <p>DIN 975</p>	050.5210.--	M6	1000		
	050.5214.--	M8	2000		
	050.5215.--	M10	2000		
	050.5216.--	M12	3000		
	050.5220.--	M10	1000		
	050.5221.--*	M10	45		
	079.5222.--	M10	3000		
	* used in assembly, sales = no				

CP 155 CP 155-LS

BEVESTIGINGSMIDDELEN
MOYENS DE FIXATION
FIXINGS
BEFESTIGUNGSMITTEL



		d	afm. dimen. L	dimen. Masse k	D
	054.5475.--	10	80		
	054.5480.--	10	95		
	054.5469.--	12	110		
	054.5460.-- CHEMISCH ANKER M12 x 145MM ANCRAGE CHEMIQUE M12 x 145MM CHEMICAL ANCHORING M12 x 145MM CHEMISCHER ANKER M12 x 145MM				
	0FR.9883.-- 0FR.9884.--	6 6	90 80	4 4	10 10

CP 155 CP 155-LS

BEVESTIGINGSMIDDELEN
MOYENS DE FIXATION
FIXINGS
BEFESTIGUNGSMITTEL



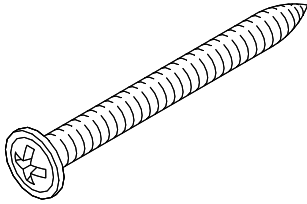
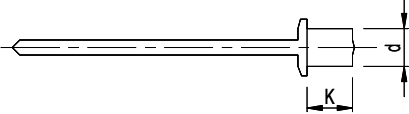
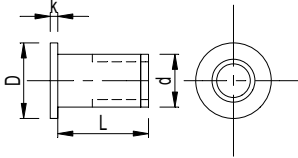
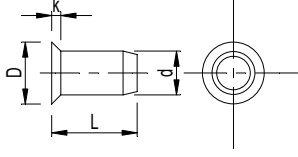

		d	afm. dimen. L	dimen. Masse k	D
	052.5303.--	5	50		
	055.5620.-- 055.5631.-- 055.5640.-- 055.5650.-- 055.5660.--	4 3 4 4 4		6 8 8 10 15	
	057.5710.-- ALU. 057.5717.-- INOX 057.5720.-- ALU.	M5 M5 M6	12 12 14		
	057.5709.-- ALU. 057.5711.-- ALU. 057.5713.-- (200 pc) INOX 057.5714.-- INOX 057.5721.-- ALU.	M4 M5 M5 M5 M6	11.5 12 13.7 11.6 15		

CP 155
CP 155-LS

BEVESTIGINGSMIDDELEN
MOYENS DE FIXATION
FIXINGS
BEFESTIGUNGSMITTEL

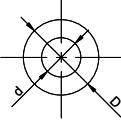
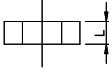

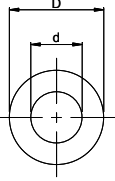
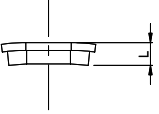

			d	afm. dimen. L	dimen. Masse k	D
			054.5452.01	5.2	3	10
			054.5440.--	6.8	3	12.5

CP 155 CP 155-LS

BEVESTIGINGSMIDDELEN
MOYENS DE FIXATION
FIXINGS
BEFESTIGUNGSMITTEL



			d	afm. dimen. L	dimen. Masse k	D
  	068.5932.--	4	11		7	

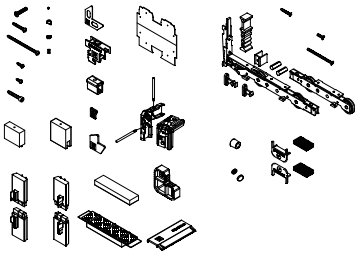
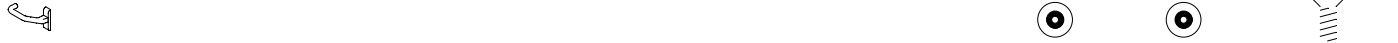



082.5401.--
 SCHUIFDEUR KIT -LS
 PORTE COULISSANTE KIT -LS
 SLIDING DOOR KIT -LS
 SCHIEBETUER -LS

CP 155-LS

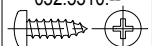
- 

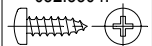
2 st./pc
 050.5051.--
 DIN 965
 M6 x 30
- 

20 st./pc
 052.5310.--
 DIN 7981
 4.2 x 16
- 

8 st./pc
 052.5304.--
 DIN 7981
 4.8 x 90
- 

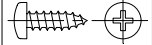
20 st./pc
 052.5371.--
 -
 6.3 x 38
- 

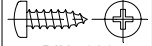



8 st./pc
 052.5301.--
 DIN 7981
 4.8 x 38
- 

8 st./pc
 052.5317.--
 DIN 7981
 4.2 x 13



CP 155-LS

BASISSET AUTOMATISCHE HEFSCHUIFDEUR
SET DE BASE SOULEV. COULISSANT AUTOMATIQUE
BASIC SET AUTOMATIC LIFT AND SLIDING DOOR
GRUNDKARTON AUTOMATISCHE HEBESCHIEBETUER

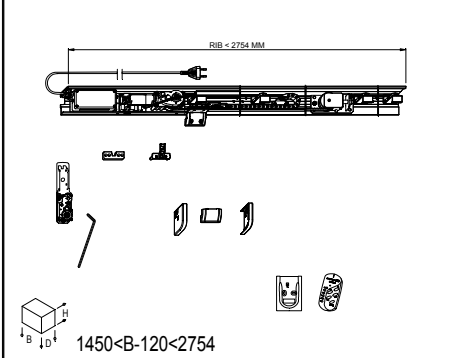
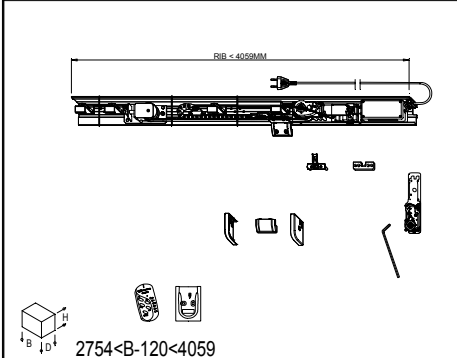
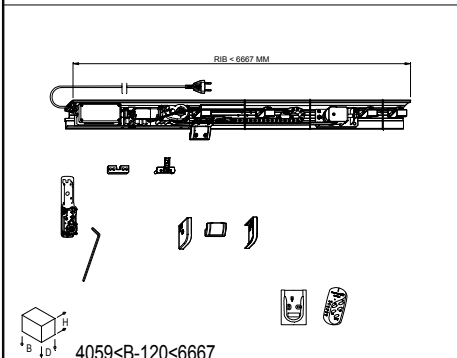
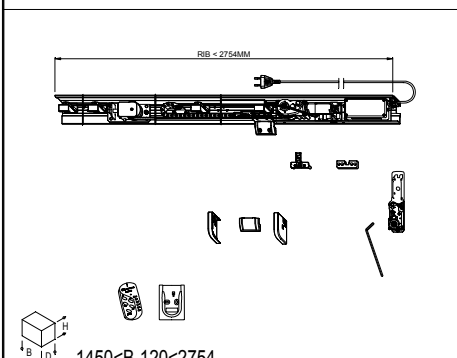
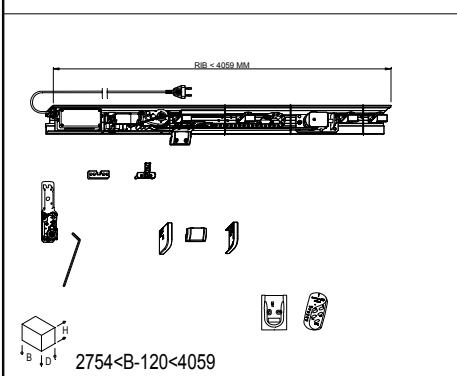

				
 <p>1450<B-120<2754</p>	<p>062.6787.SY</p> <p>BASISSET AUTOM.HEFSCHUIFDEUR DIN L SET DE BASE SOULEV.COULISSANT AUTOM. DIN L BASIC SET AUTOM.LIFT AND SLIDING DOOR DIN L GRUNDKARTON AUTOM.HEBESCHIEBETUER DIN L</p>	<p>CP 155-LS</p>		
 <p>2754<B-120<4059</p>	<p>062.6788.SY</p> <p>BASISSET AUTOM.HEFSCHUIFDEUR DIN L SET DE BASE SOULEV.COULISSANT AUTOM. DIN L BASIC SET AUTOM.LIFT AND SLIDING DOOR DIN L GRUNDKARTON AUTOM.HEBESCHIEBETUER DIN L</p>	<p>CP 155-LS</p>		
 <p>4059<B-120<6667</p>	<p>062.6789.SY</p> <p>BASISSET AUTOM.HEFSCHUIFDEUR DIN L SET DE BASE SOULEV.COULISSANT AUTOM. DIN L BASIC SET AUTOM.LIFT AND SLIDING DOOR DIN L GRUNDKARTON AUTOM.HEBESCHIEBETUER DIN L</p>	<p>CP 155-LS</p>		
 <p>1450<B-120<2754</p>	<p>062.6790.SY</p> <p>BASISSET AUTOM.HEFSCHUIFDEUR DIN R SET DE BASE SOULEV.COULISSANT AUTOM. DIN R BASIC SET AUTOM.LIFT AND SLIDING DOOR DIN R GRUNDKARTON AUTOM.HEBESCHIEBETUER DIN R</p>	<p>CP 155-LS</p>		
 <p>2754<B-120<4059</p>	<p>062.6791.SY</p> <p>BASISSET AUTOM.HEFSCHUIFDEUR DIN R SET DE BASE SOULEV.COULISSANT AUTOM. DIN R BASIC SET AUTOM.LIFT AND SLIDING DOOR DIN R GRUNDKARTON AUTOM.HEBESCHIEBETUER DIN R</p>	<p>CP 155-LS</p>		

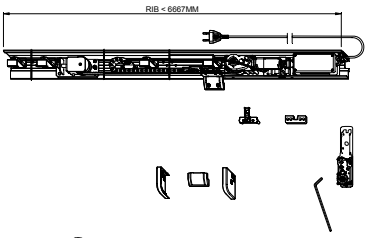

 <p>RIB = 6667MM</p> <p>4059<B-120<6667</p>	<p>062.6792.SY</p> <p>BASISSET AUTOM.HEFSCHUIFDEUR DIN R SET DE BASE SOULEV.COULISSANT AUTOM. DIN R BASIC SET AUTOM.LIFT AND SLIDING DOOR DIN R GRUNDKARTON AUTOM.HEBESCHIEBETUER DIN R</p>	<p>CP 155-LS</p>		
 <p>H=235 B=53 D=42</p>	<p>062.6793.PA</p> <p>AFDEKKAP CAPUCHON FACE CAP ABDECKKAPPE</p>	<p>CP 155-LS</p>		



086.9191.--

SMEERSTIFT
BROCHE DE GRAISSAGE
LUBRICATOR STICK
SCHMIERSTIFT



CP 155 CP 155-LS

BOORMAL T-VERBINDING VARIABEL
CALIBRE DE PERCAGE RACCORDEMENT-T VARIABLE
BORING JIG T-CONNECTION ADJUSTABLE
BOHRLEHRE T-VERBINDUNG VERSTELLBAR



097.0009.00

BOORMAL T-VERBINDING VARIABEL
CALIBRE DE PERCAGE RACCORDEMENT-T VARIABLE
BORING JIG T-CONNECTION ADJUSTABLE
BOHRLEHRE T-VERBINDUNG VERSTELLBAR

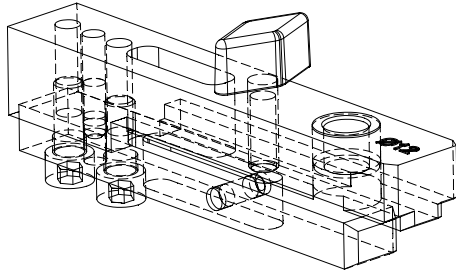

CP 155
008.0114.XX
008.3113.XX
008.3114.XX
008.3120.XX
008.3123.XX
008.3824.XX
0K8.3824.XX

CP 155-LS
008.3113.XX
008.3114.XX
008.3120.XX
008.3123.XX
008.3824.XX
0K8.3824.XX

CS 59
CS 59-Re
CS 59-So
CS 68
CS 68-HV
CS 68-Re
CS 68-So
TP 110
CP 130
CP 130-LS
CW 50
CW 60
CS 68-FP
CS 77
CS 77-HV
CS 77-BP
CS 77-FP

TP 110-Re
Eco system
CS 86-HI
Eco system-AP
CS 77-Re

CS 59-HV



097.0010.00

PEN BEVESTIGING NAGEL
GOUVILLE FIXATION CHEVILLE
PEN FIXATION DRIVE PIN
HANDDOEPPER MONTAGE STIFT

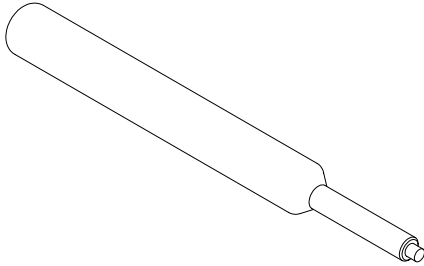

GENERAL

CS 59
CS 59-HV
CS 59-Re
CS 59-So
CS 68
CS 68-HV
CS 68-Re
CS 68-So
CP 130
CP 130-LS
CP 155
CP 155-LS
CS 77
CS 77-HV
CS 86-HI

CS 77-Re
CF 77
CS 104
CS 77-SP
CF 77-AP

097.0410.00

BOORMAL T-VERBINDING
CALIBRE RACCORDEMENT-T
BORING JIG T-CONNECTION
BOHRLEHRE T-VERBINDUNG

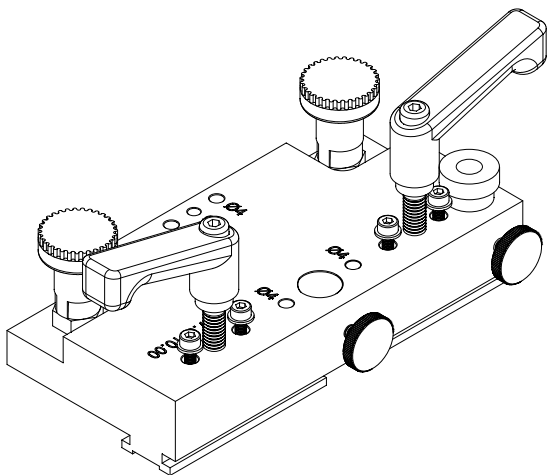

CP 155
006.2340.XX
006.2344.XX
008.0114.XX
008.3113.XX
008.3114.XX
008.3120.XX
008.3123.XX
008.3824.XX
0K8.3824.XX

CP 155-LS
006.2340.XX
006.2344.XX
008.3113.XX
008.3114.XX
008.3120.XX

008.3123.XX
008.3824.XX
0K8.3824.XX

CP 130
CP 130-LS
CS 77
CS 77-BP
CS 77-FP
CP 155-AP
CP 155-LS/AP
CS 77-Re
CS 77-SP

CP 155 CP 155-LS

BOORMAL ONTWATERING
CALIBRE DE PERCAGE DRAINAGE
BORING JIG DRAINAGE
BOHRLEHRE ENTWAESSERUNG

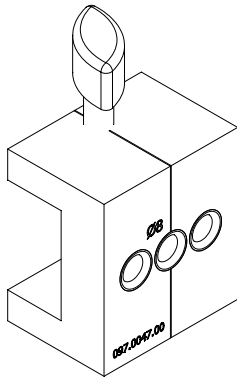

097.0047.00

BOORMAL ONTWATERING
CALIBRE DE PERCAGE DRAINAGE
BORING JIG DRAINAGE
BOHRLEHRE ENTWAESSERUNG



CP 155-LS

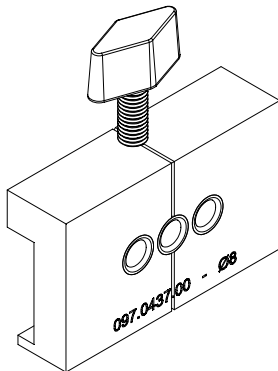

097.0437.00

BOORMAL ONTWATERING
CALIBRE DE PERCAGE DRAINAGE
BORING JIG DRAINAGE
BOHRLEHRE ENTWAESSERUNG



CP 155
006.0320.XX
006.1300.XX

CP 155-LS
006.0320.XX
006.1300.XX

CP 155-AP
CP 155-LS/AP

D0014062

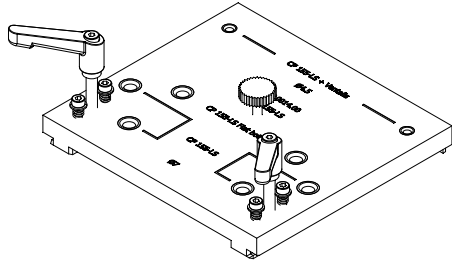

097.0014.00

BOORMAL SCHROEFVERBINDING
 CALIBRE DE PERCAGE JONCTION A VISSER
 BORING JIG SCREW CONNECTION
 BOHRLEHRE VERSCHRAUBUNG

SZABLON DO POLACZEN SKRECANYCH



CP 155	006.0320.XX			
006.0320.XX	006.1300.XX			
006.1300.XX	006.1302.XX			

CP 155-LS	VENTALIS			
006.0317.XX				
006.0318.XX				
006.0320.XX				
006.1300.XX				
006.1302.XX				
006.1322.XX				

CP 155-AP				
006.0320.XX				
006.1300.XX				

CP 155-LS/AP

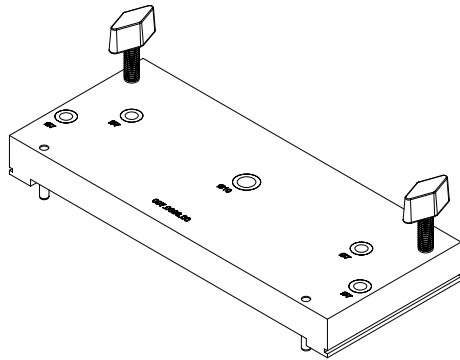

097.0698.00

BOORMAL SCHROEFVERBINDING
 CALIBRE DE PERCAGE JONCTION A VISSER
 BORING JIG SCREW CONNECTION
 BOHRLEHRE VERSCHRAUBUNG

SZABLON DO POLACZEN SKRECANYCH



CP 155				
006.1400.XX				

CP 155-LS				
006.1400.XX				
006.1402.XX				

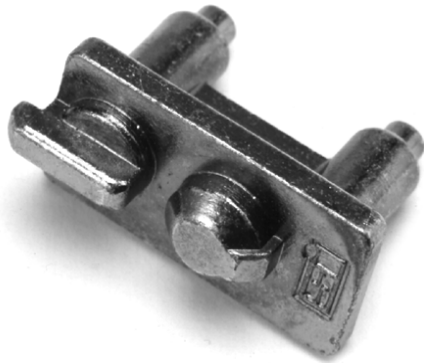

097.0296.00

BOORMAL SLOTPAD
CALIBRE DE PERCAGE GACHE
BORING JIG RECIEVER
BOHRLEHRE SCHLIESSBLECH



CP 155-LS
062.6800.--

062.7867.--

062.7869.--

062.7871.--

TLS 110

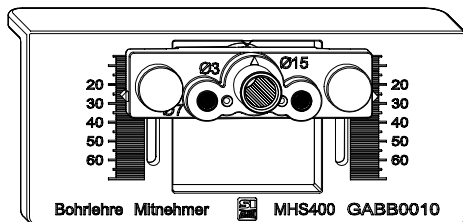

097.0683.07

BOORMAL
CALIBRE DE PERCAGE
BORING JIG
BOHRLEHRE



CP 155
006.2340.XX

CP 155-LS
062.6787.SY

062.6788.SY

062.6789.SY

062.6790.SY

062.6791.SY

062.6792.SY

CP 155 CP 155-LS

BOORMAL SCHROEFHOEK
CALIBRE DE PERCAGE EQUERRE A VISSER
BORING JIG SCREW CORNER CLEAT
BOHRLEHRE SCHRAUBECKWINKEL

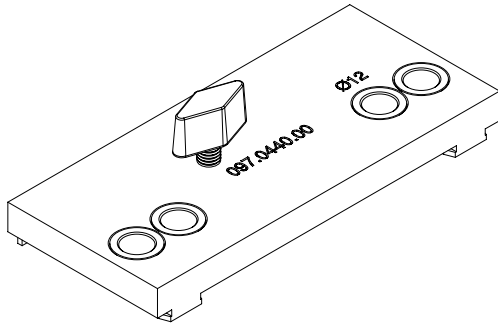

097.0440.00

BOORMAL SCHROEFHOEK
CALIBRE DE PERCAGE EQUERRE A VISSER
BORING JIG SCREW CORNER CLEAT
BOHRLEHRE SCHRAUBECKWINKEL



CP 155
006.0320.XX
006.1300.XX

CP 155-LS
006.0320.XX
006.1300.XX

CP 155-AP
CP 155-LS/AP

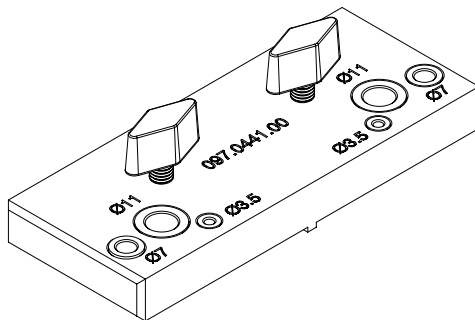

097.0441.00

BOORMAL SCHROEFHOEK
CALIBRE DE PERCAGE EQUERRE A VISSER
BORING JIG SCREW CORNER CLEAT
BOHRLEHRE SCHRAUBECKWINKEL



CP 155
006.2340.XX
006.2344.XX

CP 155-LS
006.2340.XX
006.2344.XX

CP 155-AP
CP 155-LS/AP

D0014063

CP 155 CP 155-LS

PONSUNIT HOEK- EN T-VERBINDING
UNITE D'ETAMPER CONNECTION D'EQUERRE ET TRAVE
PUNCH UNIT CORNER AND T-CONNECTION
STANZEIHEIT ECK- UND T-VERBINDUNG

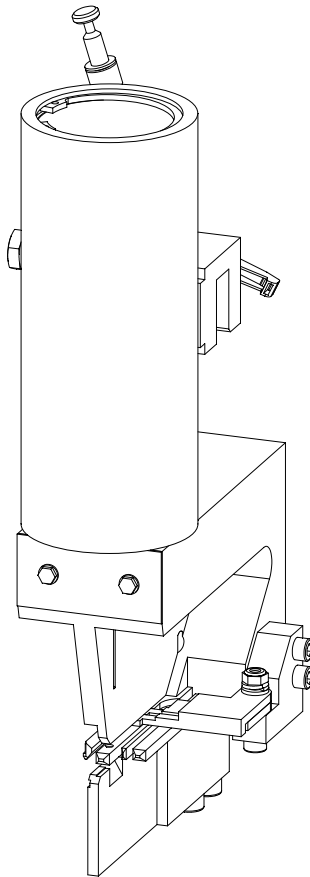

097.O900.00

PONSUNIT HOEK- EN T-VERBINDING
UNITE D'ETAMPER CONNECTION D'EQUERRE ET TRAVE
PUNCH UNIT CORNER AND T-CONNECTION
STANZEIHEIT ECK- UND T-VERBINDUNG



CP 155
008.3113.XX

CP 155-LS
008.3113.XX

CS 59
CS 59-HV
CS 59-Re
CS 59-So
CS 68
CS 68-HV
CS 68-Re
CS 68-So
TP 110
CP 130
CP 130-LS

CS 68-FP
CS 77
CS 77-HV
CS 86-HI
CS 77-Re

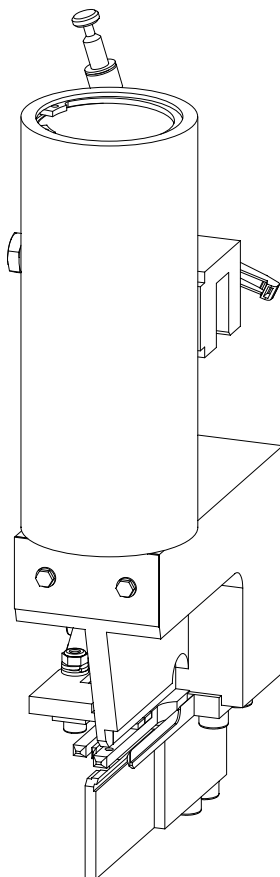

097.P000.00

PONSUNIT HOEK- EN T-VERBINDING
UNITE D'ETAMPER CONNECTION D'EQUERRE ET TRAVE
PUNCH UNIT CORNER AND T-CONNECTION
STANZEIHEIT ECK- UND T-VERBINDUNG



CP 155
008.3113.XX

CP 155-LS
008.3113.XX

CS 59
CS 59-HV
CS 59-Re
CS 59-So
CS 68
CS 68-HV
CS 68-Re
CS 68-So
TP 110
CP 130
CP 130-LS

CS 68-FP
CS 77
CS 77-HV
CS 86-HI
CS 77-Re

CP 155 CP 155-LS

PONSUNIT HOEK- EN T-VERBINDING
UNITE D'ETAMPER EQUERRE A VISSER - INJECTION
PUNCH UNIT CORNER CLEAT - GLUE INJECTIO
STANZEIHEIT ECK- UND T-VERBINDUNG

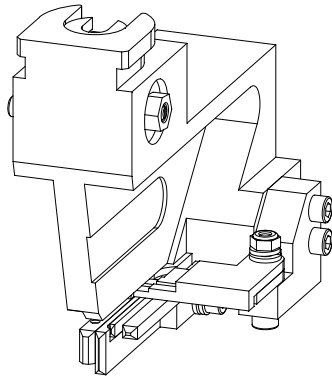

097.X000.00

PONSUNIT SCHROEFHOEK - LIJMINJECTIE & T-VERBI
UNITE D'ETAMPER EQUERRE A VISSER - INJECTION
PUNCH UNIT SCREW CORNER CLEAT - GLUE INJECTIO
STANZEIHEIT SCHRAUBECKWINKEL - LEIMINJEKTION



<p>CP 155 008.0114.XX 008.3114.XX 008.3120.XX 008.3123.XX 008.3824.XX 0K8.3824.XX</p> <p>CP 155-LS 008.3114.XX 008.3120.XX 008.3123.XX 008.3824.XX 0K8.3824.XX</p> <p>CS 59 CS 59-Re</p>	<p>CS 59-So CS 59-AD CS 68 CS 68-HV CS 68-Re CS 68-So TP 110 CP 130</p> <p>CP 130-LS CS 68-FP CS 77 CS 77-HV CS 77-BP CS 77-FP CP 96 CP 96-LS CP 96-AP</p>	<p>CP 96-LS/AP CS 86-HI CS 77-Re CF 77 CS 104 CS 77-SP CF 77-AP</p> <p>CS 59-HV</p>		
--	--	---	--	--

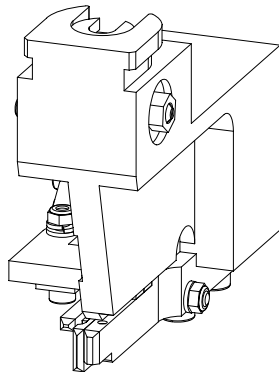

097.X100.00

PONSUNIT SCHROEFHOEK - LIJMINJECTIE & T-VERBI
UNITE D'ETAMPER EQUERRE A VISSER - INJECTION
PUNCH UNIT SCREW CORNER CLEAT - GLUE INJECTIO
STANZEIHEIT SCHRAUBECKWINKEL - LEIMINJEKTION



<p>CP 155 008.0114.XX 008.3114.XX 008.3120.XX 008.3123.XX 008.3824.XX 0K8.3824.XX</p> <p>CP 155-LS 008.3114.XX 008.3120.XX 008.3123.XX 008.3824.XX 0K8.3824.XX</p> <p>CS 59 CS 59-Re</p>	<p>CS 59-So CS 59-AD CS 68 CS 68-HV CS 68-Re CS 68-So TP 110 CP 130</p> <p>CP 130-LS CS 68-FP CS 77 CS 77-HV CS 77-BP CS 77-FP CP 96 CP 96-LS CP 96-AP</p>	<p>CP 96-LS/AP CS 86-HI CS 77-Re CF 77 CS 104 CS 77-SP CF 77-AP</p> <p>CS 59-HV</p>		
--	--	---	--	--

CP 155 CP 155-LS

PONSUNIT T-VERBINDUNG
UNITE D'ETAMPER JONCTION-T
PUNCH UNIT T-BRACKET
STANZEINHEIT T-VERBINDUNG

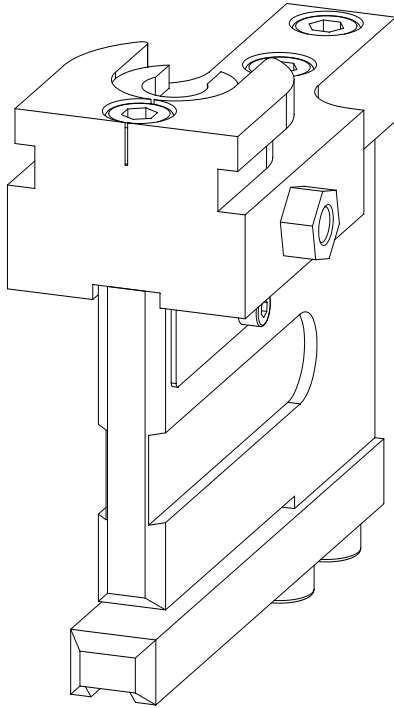

097.X300.00

PONSUNIT T-VERBINDUNG
UNITE D'ETAMPER JONCTION-T
PUNCH UNIT T-BRACKET
STANZEINHEIT T-VERBINDUNG



CP 155
008.0114.XX
008.3113.XX
008.3114.XX
008.3120.XX
008.3123.XX
008.3824.XX
0K8.3824.XX

CP 155-LS
008.3113.XX
008.3114.XX
008.3120.XX
008.3123.XX
008.3824.XX
0K8.3824.XX

CS 59
CS 59-Re
CS 59-So
CS 59-AD
CS 68
CS 68-Re
CS 68-So
TP 110
CP 130
CP 130-LS
CS 68-FP
CS 77
CS 77-BP
CS 77-FP
CS 86-HI
CS 77-Re
CF 77

CS 77-SP
CF 77-AP

CP 155 CP 155-LS

PONSUNIT ONTWATERING
UNITE D'ETAMPER DRAINAGE
PUNCH UNIT DRAINAGE
STANZEINHEIT ENTWAESSERUNG

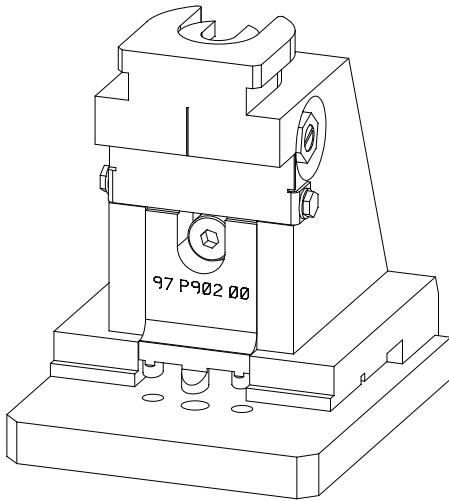

097.P900.00

PONSUNIT ONTWATERING
UNITE D'ETAMPER DRAINAGE
PUNCH UNIT DRAINAGE
STANZEINHEIT ENTWAESSERUNG



CP 155 008.0114.XX 008.3113.XX 008.3824.XX 0K8.3824.XX	TP 110 CP 130 CP 130-LS CW 50 CW 60 CS 68-FP CS 77 CS 77-HV CS 77-BP CS 77-FP Eco system CS 86-HI Eco system-AP Eco system Optima	CS 59-HV		
CP 155-LS 008.3113.XX 008.3824.XX 0K8.3824.XX	CF 77 CS 77-SP CF 77-AP			
CS 59Pa CS 59 CS 59-AD CS 59-SD CS 68 CS 68-HV				

D00084692

CP 155 CP 155-LS

PONSUNIT WISSELPROFIEL
UNITE D'ETAMPER CHICANE
PUNCH UNIT MEETING SECTION
STANZEINHEIT WECHSELPROFIL

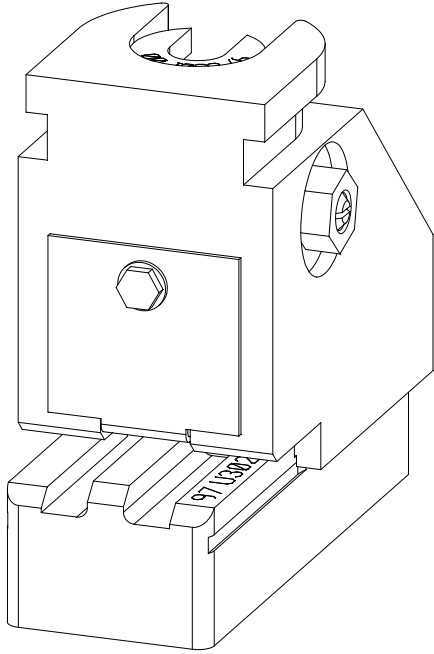

097.U300.00

PONSUNIT WISSELPROFIEL
UNITE D'ETAMPER CHICANE
PUNCH UNIT MEETING SECTION
STANZEINHEIT WECHSELPROFIL



CP 155
006.1342.XX

CP 155-LS
006.1342.XX

CP 155-AP
006.1342.XX

CP 155-LS/AP
006.1342.XX

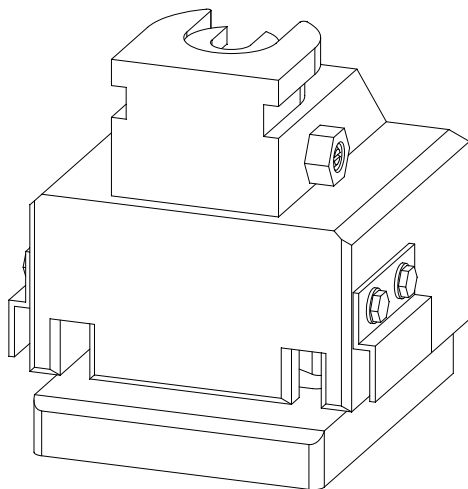

097.U400.00

PONSUNIT WISSELPROFIEL
UNITE D'ETAMPER CHICANE
PUNCH UNIT MEETING SECTION
STANZEINHEIT WECHSELPROFIL



CP 155
006.1342.XX

CP 155-LS
006.1342.XX

CP 155-AP
006.1342.XX

CP 155-LS/AP
006.1342.XX

D0075005

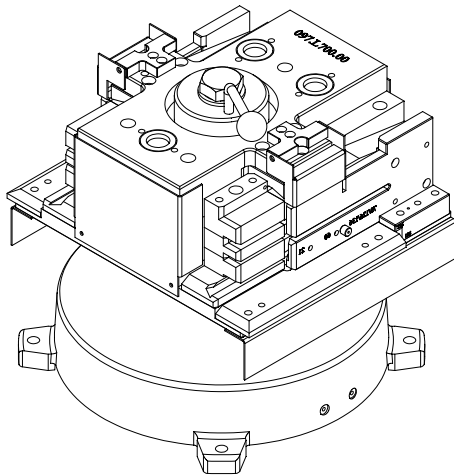

097.L700.00

PONSUNIT SCHROEFVERBINDING
 UNITE D'ETAMPER JONCTION A VISSER
 PUNCH UNIT SCREW CONNECTION
 STANZEINHEIT VERSCHRAUBUNG



CP 155-LS
 CP 155-LS/AP
 VENTALIS

CP 155 CP 155-LS

SJABLONE VOOR 095.A700.00
 POCHOIR POUR 095.A700.00
 STENCIL PLATE FOR 095.A700.00
 SCHABLONE FEUR 095.A700.00

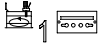

095.A730.00

SJABLONE
 POCHOIR
 STENCIL PLATE
 SCHABLONE

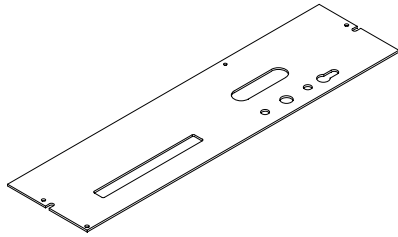

CP 155
 062.7864.PA

062.7865.PA

CP 155-LS
 062.7864.PA
 006.2340.XX

062.7865.PA

TLS 110

CP 155 CP 155-LS

SJABLONE VOOR 095.B300.00
 POCHOIR POUR 095.B300.00
 STENCIL PLATE FOR 095.B300.00
 SCHABLONE FEUR 095.B300.00



095.B323.00

SJABLONE
 POCHOIR
 STENCIL PLATE
 SCHABLONE

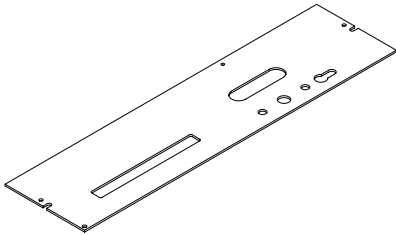

CP 155-LS

062.7861.PA
 006.2340.XX

062.7868.ZC
 006.2340.XX

062.7862.PA
 006.2340.XX

062.6902.ZC

062.7863.PA
 006.2340.XX

TLS 110
 CP 155-LS/AP

062.7864.PA
 006.2340.XX

062.7865.PA

062.7872.PA
 006.2440.XX

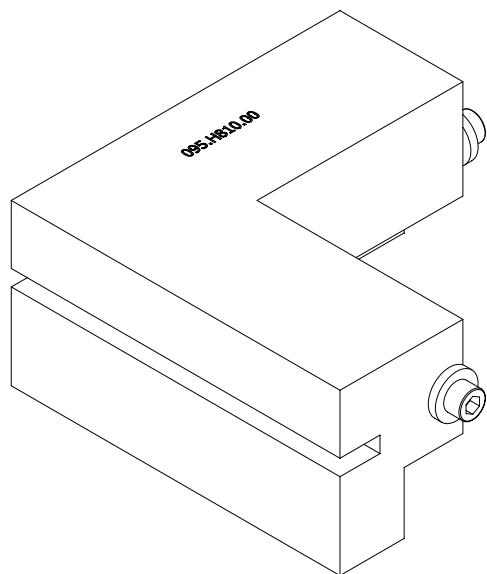

095.H810.00

PERSBLOK
 ENCLUME
 PRESS BLOCK
 PRESSBLOCK

CP 155 006.1300.XX 006.1400.XX	CW 60-SC CW 60-HL CW 65-EF			
CP 155-LS 006.1300.XX 006.1400.XX	CS 59Pa-SD CS 59-SD TP 110 TLS 110			
CP 130 CW 50 CW 50-HI CW 50-HL CW 60 CS 77 CW 50-SC CP 155-AP CP 155-LS/AP	MOSQUITO CW 50-SG Eco system CW 86-EF/HI Eco system Optima Eco system 75			

CP 155 CP 155-LS

PERSBLOKKEN
ECLUMES
PRESSBLOCKS
PRESS BLOCHE

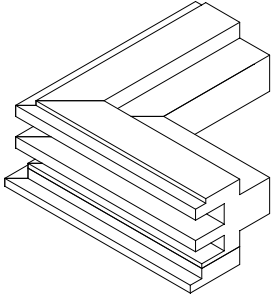
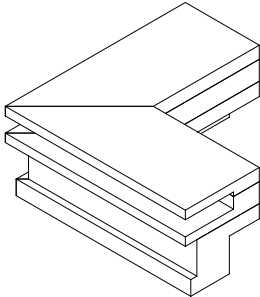
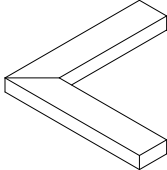
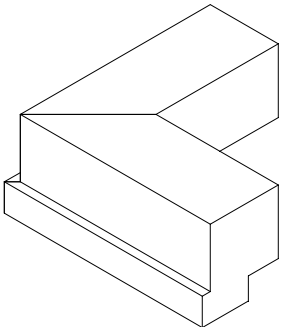

	<p>097.A200.00 PERSBLOK CONCEPT ENCLUME CONCEPT PRESS BLOCK CONCEPT PRESSBLOCK CONCEPT</p>	<p>CP 155 006.0320.XX 006.2344.XX</p> <p>CP 155-LS 006.0320.XX 006.2344.XX</p> <p>CS 59 CS 68-FP CS 77 CS 77-BP CW 50-SC CP 155-AP CP 155-LS/AP Eco system</p>	<p>Eco system-AP CW 60-SC</p> <p>CS 68</p>
	<p>097.C000.00 PERSBLOK CONCEPT ENCLUME CONCEPT PRESS BLOCK CONCEPT PRESSBLOCK CONCEPT</p>	<p>CP 155 006.0320.XX</p> <p>CP 155-LS 006.0320.XX</p> <p>CS 59 CS 68 CP 130 CP 130-LS CW 50-HI CS 68-FP CS 77</p> <p>Eco system CS 86-HI Eco system-AP</p>	<p>CW 65-EF</p>
	<p>097.D300.00 HULPSTUK SETMATIC ACCESSOIRE SETMATIC ACCESSORY SETMATIC ZUBEHOER SETMATIC</p>	<p>CP 155 006.1300.XX 006.1400.XX</p> <p>CP 155-LS 006.1300.XX 006.1400.XX</p> <p>CS 59Pa CS 59 CS 59-Re CS 59-So CS 68-Re CS 68-So CW 50 CW 50-HL</p>	<p>CW 60 TR 200 MOSQUITO CR 120 CS 77 CW 50-SC CP 155-AP CP 155-LS/AP Eco system CS 38-SL CS 38-SL/AP CW 60-SC CW 60-HL CS 77-Re CW 65-EF Eco system 75</p>
	<p>097.E900.00 PERSBLOK CONCEPT ENCLUME CONCEPT PRESS BLOCK CONCEPT PRESSBLOCK CONCEPT</p>	<p>CP 155 006.2340.XX</p> <p>CP 155-LS 006.2340.XX</p> <p>CS 59 CS 68 CS 68-Re CS 77 CP 155-AP CP 155-LS/AP CS 77-Re</p>	

D0046332

CP 155 CP 155-LS

MESEN
COUTEAUX
KNIVES
MESSER



	<p>095.H850.00 MESEN VOOR 095.H800.00 2.5MM COUTEAUX POUR 095.H800.00 2.5MM KNIVES FOR 095.H800.00 2.5MM MESSER FUER 095.H800.00 2.5MM</p>	<p>CP 155 006.2340.XX 006.2344.XX</p> <p>CP 155-LS 006.2340.XX 006.2344.XX</p> <p>CP 155-AP 006.2340.XX 006.2344.XX</p> <p>CP 155-LS/AP 006.2340.XX 006.2344.XX</p> <p>CS 59Pa CS 58 CW 60 TR 200 MOSQUITO</p>	<p>CR 120 CW 50-SG CW 60-SG CP 96 CP 45Pa CP 96-LS CP 96-AP CP 96-LS/AP CS 68 Optima Eco system CS 38-SL Eco system-AP CS 38-SL/AP CS 24-SL CS 24-SL/AP Eco system Optima CW 65-EF CP 45Pa (GR) CS 38-SL Optima CS 77 Optima</p> <p>CS 77</p>
	<p>095.H853.00 MESEN VOOR 095.H800.00 8MM COUTEAUX POUR 095.H800.00 8MM KNIVES FOR 095.H800.00 8MM MESSER FUER 095.H800.00 8MM</p>	<p>CP 155 006.0320.XX 006.1300.XX 006.1400.XX 008.3113.XX 008.3114.XX 008.3120.XX 008.3123.XX 008.3848.XX</p> <p>CP 155-LS 006.0320.XX 006.1300.XX 006.1400.XX 008.3113.XX 008.3114.XX 008.3120.XX 008.3123.XX 008.3848.XX</p> <p>CP 155-AP 006.0320.XX</p>	<p>006.1300.XX</p> <p>CP 155-LS/AP 006.0320.XX 006.1300.XX</p> <p>PS 50-SP CS 59Pa CS 59 CS 59-HV CS 59-Re CS 59-So CS 59-SD CS 68 CS 68-HV CS 68-Re CS 68-So TP 110 TP 138 CP 130 CP 130-LS CW 50</p>
	<p>095.H856.00 MESEN VOOR 095.H800.00 COUTEAUX POUR 095.H800.00 KNIVES FOR 095.H800.00 MESSER FUER 095.H800.00</p>	<p>CP 155 006.2340.XX 006.2344.XX</p> <p>CP 155-LS 006.2340.XX 006.2344.XX</p> <p>CP 155-AP 006.2340.XX 006.2344.XX</p> <p>CP 155-LS/AP 006.2340.XX 006.2344.XX</p>	

CP 155 CP 155-LS

PERSBLOK VOOR 095.B500.00
ENCLUME POUR 095.B500.00
PRESS BLOCK FOR 095.B500.00
PRESSBLOCK FUER 095.B500.00



095.B532.00

PERSBLOK D=30MM L=ST
ENCLUME D=30MM L=ST
PRESS BLOCK D=30MM L=ST
PRESSBLOCK D=30MM L=ST

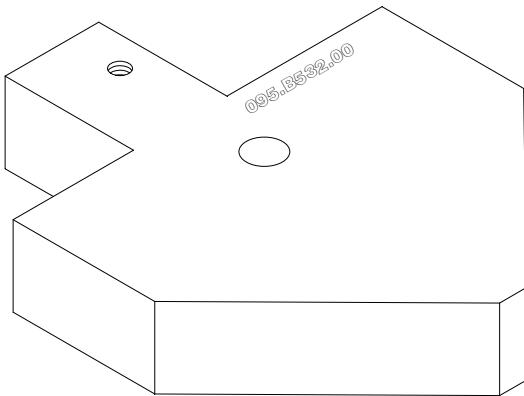

<p>CP 155 006.0320.XX</p> <p>CS 59Pa CS 59Pa-SD CS 59 CS 59-HV CS 59-SD CS 68 CS 68-HV CS 68-Re TP 110 CP 130 CW 50 CW 50-HL CW 60 MOSQUITO</p>	<p>CS 77 CW 86 CW 86-SG CS 77-HV CW 50-SC CW 50-SG CP 96 CW 86-EF CP 96-LS CP 96-AP CP 96-LS/AP TP 110-Re Eco system CS 38-SL CS 86-HI Eco system-AP CS 38-SL/AF</p>	<p>CS 24-SL CW 60-SC CW 60-HL CS 24-SL/AP CW 86-EF/HI Eco system Optima CW 65-EF CW 65-EF/SG CW 65-EF/HI CF 77</p> <p>TP 138 CP 155-LS TR 200 CR 120 CS 77-BP Eco system Optima-AP</p>		
---	--	--	--	--

095.B533.00

PERSBLOK D=11 L=ST-4MM
ENCLUME D=11 L=ST-4MM
PRESS BLOCK D=11 L=ST-4MM
PRESSBLOCK D=11 L=ST-4MM

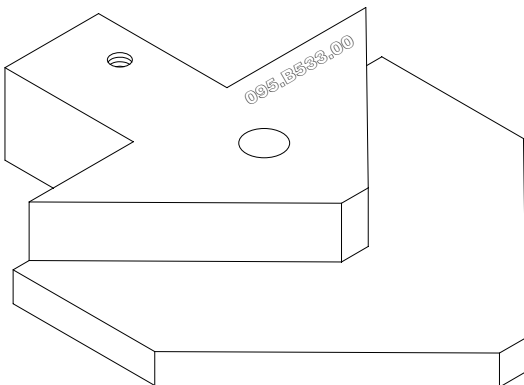

<p>CP 155 006.0320.XX 008.0114.XX 008.3113.XX 008.3114.XX 008.3120.XX 008.3123.XX</p> <p>CP 155-LS 008.3113.XX 008.3114.XX 008.3120.XX 008.3123.XX</p> <p>PS 50-SP CS 59Pa CS 59</p>	<p>CS 59-HV CS 59-Re CS 59-So CS 59-CD CS 59-SD CS 68 CS 68-HV CS 68-Re CS 68-So TP 110 TP 138 TLS 110 CP 130 CP 130-LS CW 50 CW 50-HI CW 60</p>	<p>CS 68-FP CS 77 CS 77-HV CS 77-BP CW 50-SC CS 77-FP CW 60-DRL CP 45Pa TP 110-Re CS 68 Optima Eco system CS 86-HI Eco system-AP CW 60-SC CS 77-Re Eco system Optima Eco system 75</p>	<p>CF 77 CS 68 Optima-AP Eco system Optima-AP</p>	
--	--	--	---	--

CP 155 CP 155-LS

PERSBLOK VOOR 095.B500.00
ENCLUME POUR 095.B500.00
PRESS BLOCK FOR 095.B500.00
PRESSBLOCK FUER 095.B500.00



095.B533.00

PERSBLOK D=11 L=ST-4MM
ENCLUME D=11 L=ST-4MM
PRESS BLOCK D=11 L=ST-4MM
PRESSBLOCK D=11 L=ST-4MM

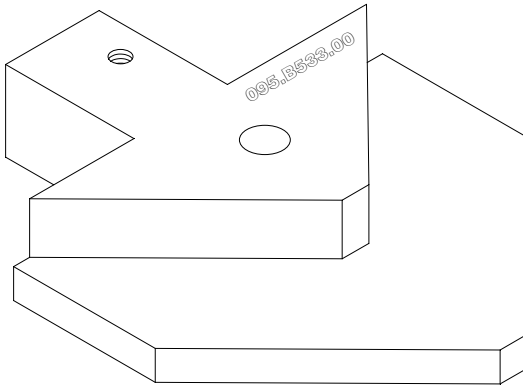

CP 155
006.0320.XX
008.0114.XX
008.3113.XX
008.3114.XX
008.3120.XX
008.3123.XX

CP 155-LS
008.3113.XX
008.3114.XX
008.3120.XX
008.3123.XX

PS 50-SP
CS 59Pa
CS 59

CS 59-HV
CS 59-Re
CS 59-So
CS 59-CD
CS 59-SD
CS 68
CS 68-HV
CS 68-Re
CS 68-So
TP 110
TP 138
TLS 110
CP 130
CP 130-LS
CW 50
CW 50-HI
CW 60

CS 68-FP
CS 77
CS 77-HV
CS 77-BP
CW 50-SC
CS 77-FP
CW 60-DRL
CP 45Pa
TP 110-Re
CS 68 Optima
Eco system
CS 86-HI
Eco system-AP
CW 60-SC
CS 77-Re
Eco system Optima
Eco system 75

CF 77

CS 68 Optima-AP
Eco system Optima-AP

095.B534.00

PERSBLOK D=11MM L=ST-1.4MM
ENCLUME D=11MM L=ST-1.4MM
PRESS BLOCK D=11MM L=ST-1.4MM
PRESSBLOCK D=11MM L=ST-1.4MM

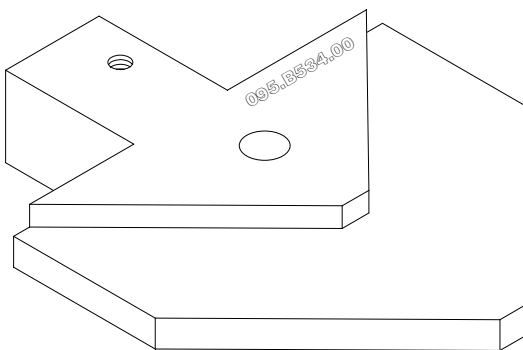

CP 155
006.2340.XX
006.2344.XX

CS 59
CS 68
CS 68-Re
CS 77
Eco system 75

CP 155-LS

CP 155 CP 155-LS

MESSEN VOOR 095.B500.00
COUTEAUX POUR 095.B500.00
KNIVES FOR 095.B500.00
MESSER FUER 095.B500.00



095.B561.00

MESSEN D=5MM L=ST
COUTEAUX D=5MM L=ST
KNIVES D=5MM L=ST
MESSER D=5MM L=ST

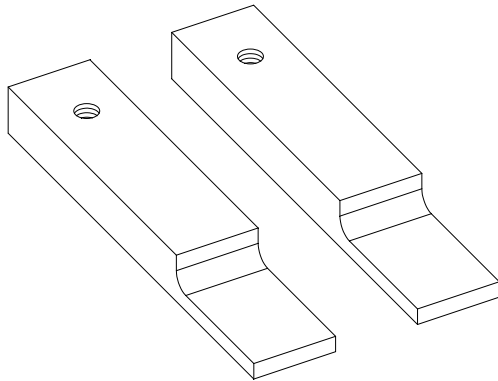

CP 155 006.2340.XX 006.2344.XX CS 59Pa-CD CS 59-CD CS 59-SD CP 130 CP 130-LS MOSQUITO CW 86 CW 86-EF Eco system CS 38-SL CS 86-HI Eco system-AP CS 38-SL/AP	CW 65-EF/HI			
--	-------------	--	--	--

095.B562.00

MESSEN D=7MM L=ST
COUTEAUX D=7MM L=ST
KNIVES D=7MM L=ST
MESSER D=7MM L=ST

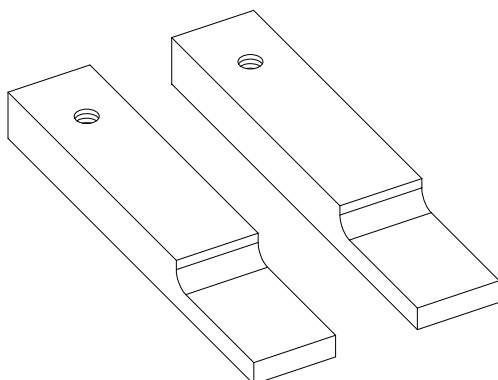

CP 155 006.0320.XX 006.1300.XX 008.0114.XX 008.3113.XX 008.3114.XX 008.3120.XX 008.3123.XX CP 155-LS 006.1300.XX 008.3113.XX 008.3114.XX 008.3120.XX 008.3123.XX PS 50-SP	CS 59Pa CS 59Pa-AD CS 59Pa-SD CS 59 CS 59-HV CS 59-Re CS 59-So CS 59-SD CS 68 CS 68-HV CS 68-Re CS 68-So TP 110 TP 138 CP 130 CP 130-LS CW 50	CW 50-HI CW 50-HL CW 60 CS 68-FP CS 77 CW 86 CW 86-SG CS 77-HV CS 77-BP CW 50-SC CW 50-SG CS 77-FP CP 155-AP CP 155-LS/AP CP 96 CW 60-DRL CP 45Pa	CW 86-EF CP 96-LS CP 96-AP CP 96-LS/AP TP 110-Re CS 68 Optima Eco system CS 38-SL CS 86-HI Eco system-AP CS 38-SL/AP CS 24-SL CW 60-SC CW 60-HL CS 24-SL/AP CW 86-EF/HI CS 77-Re	Eco system Optima CW 65-EF CW 65-EF/SG Eco system 75 CW 65-EF/HI CF 77 TR 200 MOSQUITO CR 120 CS 68 Optima-AP Eco system Optima-AP
---	---	---	--	--

D004632Z

CP 155 CP 155-LS

MESSEN VOOR 095.B500.00
 COUTEAUX POUR 095.B500.00
 KNIVES FOR 095.B500.00
 MESSER FUER 095.B500.00



095.B565.00

MESSEN D=2.5MM L=ST+26.2MM
 COUTEAUX D=2.5MM L=ST+26.2MM
 KNIVES D=2.5MM L=ST+26.2MM
 MESSER D=2.5MM L=ST+26.2MM

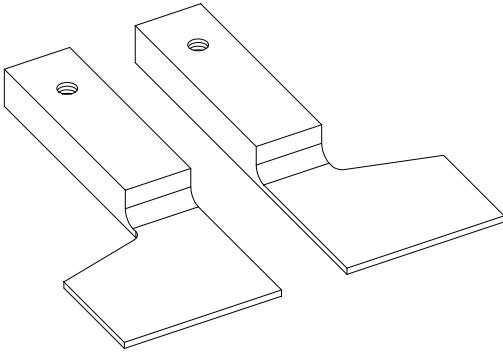

CP 155
 006.2340.XX
 006.2344.XX
 CP 155-LS

--	--	--	--	--	--



095.1000.--

AANDRUKROL
ROULEAU
ROLLER
ROLLE



CS 59Pa CS 59Pa-AD CS 59Pa-CD CS 59Pa-SD CS 59 CS 59-HV CS 59-Re CS 59-So CS 59-AD CS 59-CD CS 59-SD CS 68 CS 68-HV CS 68-Re CS 68-So TP 110 TLS 110	CP 130 CP 130-LS CP 155 CP 155-LS CS 68-FP CS 77 CS 77-HV CS 59Pa-AP CS 59-AP CS 68-AP CS 77-AP CS 77-BP CS 77-FP TP 110-AP CP 155-AP CP 155-LS/AP CP 96	CP 45Pa CP 96-LS CP 96-AP CP 96-LS/AP TP 110-Re CS 68 Optima CS 59-PD CS 68-PD CS 68-FP/PD CS 77-PD Eco system CS 38-SL CS 86-HI Eco system-AP CS 38-SL/AP CS 24-SL CS 24-SL/AP	CS 38-SL/FP CS 77-Re Eco system Optima Eco system 75 CS 86-HI/AP CS 68 Optima-AP Eco system Optima-AP CF 77 CS 104 CS 38-SL Optima CS 77-SP CS 77 Optima CF 77-AP
--	--	---	---

095.J200.00

PISTOOL PU-LIJM
PISTOLET COLLE PU
GUN GLUE PU
SPRITZE KLEBER PU



GENERAL CS 59Pa CS 59Pa-AD CS 59Pa-CD CS 59Pa-SD CS 59 CS 59-HV CS 59-Re CS 59-So CS 59-AD CS 59-CD CS 59-SD CS 68 CS 68-HV CS 68-Re CS 68-So	TP 110 TLS 110 CP 130 CP 130-LS CP 155 CP 155-LS CS 68-FP CS 77 CS 77-HV CS 59Pa-AP CS 59-AP CS 68-AP CS 77-AP CS 77-BP CS 77-FP TP 110-AP CP 155-AP	CP 155-LS/AP CP 96 CP 45Pa CP 96-LS CP 96-AP CS 68 Optima CS 59-PD CS 68-PD CS 68-FP/PD CS 77-PD Eco system CS 38-SL CS 86-HI Eco system-AP CS 38-SL/AP CS 24-SL CS 24-SL/AP	CS 38-SL/FP CS 77-Re Eco system Optima Eco system 75 CS 86-HI/AP CS 68 Optima-AP Eco system Optima-AP CF 77 CS 104 CS 38-SL Optima CS 77-SP CS 77 Optima CF 77-AP
--	--	--	---

CP 155
CP 155-LS

GEREEDSCHAP
OUTIL
TOOL
WERKZEUG

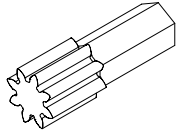

097.0754.00

BITS
BITS
BITS
BITS



GENERAL
CS 77-SP
CW 60
CW 60-SC
CW 60-HL

CP 130
CP 130-LS
CP 155
CP 155-LS
CW 50
CW 50-HL
CW 50-SC
Eco system
Eco system-AP
CW 65-EF
CF 77

CS 104
CF 77-AP

CP 155
CP 155-LS

GEREEDSCHAP
OUTIL
TOOL
WERKZEUG





www.reynaers.com